



	19	LONG BARS BARRE LUNGHE
	45	PIERCED BARS SHAPED BARS BARRE FORATE BARRE SAGOMATE
	63	OVERTHROWS CIMASE
	79	CLASSICAL PICKETS AND PANELS PALETTI E PANNELLI CLASSICI
	157	MODERN PICKETS AND PANELS PALETTI E PANNELLI MODERNI
	217	BOWED PICKETS PANCIONI
	233	PICKETS FOR FENCING PALETTI PER RECINZIONE
	247	SPEAR POINTS AND POST TOPS LANCE, POMOLI E TERMINALI A COLONNA
	263	ROSACES ROSONI
	277	SCROLLS AND SNAP-ONS RICCI E SNAP-ONS
	309	RINGS CERCHI
	315	SPHERES SFERE
	319	BUSHES BORCHIE
	333	BASKET PIGNE
	337	FLOWERS AND ROSETTE FIORI E ROSETTE
	351	DECORATIONS IN STEEL SHEET DECORI IN LAMIERA
	357	PLATES AND ACCESSORIES PIASTRE ED ACCESSORI
	377	ALLUMINIUM ALLUMINIO
	387	GALVANIZED ZINCATI
	397	BRASS OTTONE

arterferro is a brand of



GONZATO
GROUP

The best in wrought iron

Il meglio del ferro battuto

Arteferro is a division of Gonzato Group dedicated to the production of semifinished elements in wrought iron, brass and bronze. The Arteferro product line includes over 32,000 semi-finished ornamental items made of wrought iron, brass, and bronze: pierced bars, forged pickets, pre-assembled panels, leaves, flowers, baskets, roses, scrolls, rings, and other decorative elements, as well as a rich variety of home furnishings. It is the task of blacksmiths to assemble them into finished objects such as railings, fences, or any other creation suggests his creativity. Arteferro also includes the Arteferro System product line, which is characterized by an elegant and innovative style.

A small, but massive revolution!

The Compendium catalogue has been specifically organised to facilitate the search for individual items. First of all, the structural elements, like long bars, pierced bars and overthrows, then filling elements, like pickets, panels and rosaces, and then passing onto decorative elements like scrolls, circles, spheres and many others. At the end, you'll find the accessories and tools for construction site activities.

Arteferro è la divisione di Gonzato Group dedicata alla produzione di elementi semilavorati in ferro battuto, ottone e bronzo. La gamma di prodotti Arteferro comprende oltre 32.000 elementi: barre forate, paletti forgiati, pannelli preassemblati, foglie, fiori, pigne, rosoni, ricci, cerchi ed altri componenti decorativi, oltre ad una ricca serie di complementi d'arredo. Sarà compito del fabbro assemblarli in oggetti finiti come parapetti, recinzioni o qualsiasi altra creazione gli suggerisca la sua creatività. Arteferro comprende anche la linea di prodotti Arteferro System, caratterizzata da uno stile elegante ed innovativo.

Una piccola grande rivoluzione!

Il catalogo Compendium è stato organizzato appositamente per agevolare la ricerca di ogni elemento. Prima gli elementi strutturali, come le barre lunghe, le barre forate e le cimase, poi gli elementi di tamponamento, come i paletti, i pannelli, rosoni, per passare agli elementi decorativi come i ricci, i cerchi, le sfere e molti altri. Infine si troveranno gli accessori e gli utensili per l'attività di cantiere.



Copyright © 2023 Ind.i.a. spa. (Gonzato Group)
All rights reserved. Trademark, design or patent
application pending/registration or patent granted in one or more countries.
For additional information, please contact us at: info@arteferro.com

Tutti i diritti riservati. Domanda di marchio, design o brevetto
depositata/registrazione o brevetto rilasciato in uno o più paesi.
Per ulteriori informazioni, non esitare a contattarci a: info@arteferro.com

Catalogue guidelines

Guida catalogo



New products

Our designers are always at work! In Arteferro Quick, you'll find many **new articles highlighted** with a specific seal. With a classic or modern design, they're always characterized by the unique and unmistakable Arteferro style.

Nuovi prodotti

I nostri designer sono sempre all'opera! In Arteferro Quick troverai tanti **nuovi articoli evidenziati** dall'apposito bollino. Dal design classico o moderno sono comunque sempre caratterizzati dallo stile Arteferro, unico ed inconfondibile.



Easy to flip through

At the beginning of each section, on the focused cover, a description helps understand its content. Thanks to the renewed graphics it will be very easy to find the item you are looking for. In the more complex sections easy instructions will help you to better understand how they are organised.

Facile da sfogliare

All'inizio di ogni capitolo, sulla copertina dedicata, un testo descrittivo aiuta a capire cosa troverai all'interno. Grazie alla grafica rinnovata sarà un gioco da ragazzi individuare l'articolo che ti interessa. Nei capitoli più complessi abbiamo riportato delle facili istruzioni che ti aiuteranno nel comprendere la logica dell'organizzazione.

Amongst the pages, a huge amount of useful information

Created afresh, based on over forty years of experience in the industry, Compendium wants to become a really easy to use and intuitive work tool for you to consult, by virtue of its new logical layout, which enables you to find the product of interest straight away, to pass quickly from one family of articles to another, and then to go into the details with sizes and finishes.

Tra le pagine molte informazioni utili

Realizzato ex novo, sulla base di un'esperienza ultra quarantennale nel settore, Compendium vuole diventare un vero e proprio strumento di lavoro facile ed intuitivo da consultare, in virtù della nuova ragionata impaginazione che consente di trovare immediatamente il prodotto di interesse, passando celermente tra le famiglie di articoli, per poi entrare nel dettaglio con il dimensionamento e le finiture.

4.	Classical pickets and Panels Paletti e Pannelli classici		A lot of pickets and panels have been classified to make it easier for you to find what you want quickly and easily. Starting with the central motif, you can find your article by process as well as matching decorations.
A	Forged pickets	Paletti forgiati	pag. 72
B	Hammered pickets	Paletti conati	pag. 88
C	Tube pickets	Paletti in tubo	pag. 92
D	Pickets with twisting	Paletti con torciglione	pag. 94
E	Pickets with big twisting	Paletti con torciglione grande	pag. 100
F	Pickets with baskets	Paletti con pigna	pag. 102
G	"S" shaped panels	Pannelli ad "sesta"	pag. 105
H	Panels with scrolls	Pannelli con ricci	pag. 110

Starting Section box

A quick overview about how to deal with the specific section

Riquadro di inizio capitolo

Rapida panoramica su come affrontare il capitolo specifico

51.000 km

of pierced bars have been manufactured by our factories to date. The circumference of the Earth is "only" 40,075 km

di barre forate sono state prodotte fino ad oggi nei nostri stabilimenti. La circonferenza della Terra è di "soli" 40.075 km

Arteferro products can be manufactured as well as customised.

I prodotti Arteferro sono realizzabili anche su misura.

Square Circle

Useful and interesting information about our elements.

Quadrato blu

Notizie utili e curiosità sui nostri articoli.

Square Circle

Technical information and stylistic advice from our experts.

Quadrato grigio

Informazioni tecniche e consigli stilistici dei nostri esperti.

Highlights

Identify the featured articles.

Highlights

Identifica gli articoli in evidenza



items that are the intellectual property of Gonzato Group

articoli di proprietà intellettuale di Gonzato Group



special price items
articoli a prezzo speciale

HIGHLIGHTS

<p>PAG.280 10.A</p>  <p>Art. 80/A/3</p>	<p>PAG.161 5.A</p>  <p>Art. GD278/1 - GD278/2</p>	<p>PAG.253 8.A</p>  <p>Art. 725/1</p>
<p>PAG. 295 10.A</p>  <p>Art.94/F/3</p>	<p>PAG.176 5.B</p>  <p>Art.GDS20FB</p>	<p>PAG.38 1.F</p>  <p>Art. 114/4</p>
<p>PAG.207 5.G</p>  <p>Art.GD282/2</p>	<p>PAG.76 3</p>  <p>Art. GD271/3</p>	<p>PAG.229 6</p>  <p>Art.1276/1</p>
<p>PAG.170 5.B</p>  <p>Art.GD289/2</p>	<p>PAG.93 4.A</p>  <p>Art.1187/2</p>	<p>PAG.361 17.A</p>  <p>Art.F0222</p>
<p>PAG.47 2.B</p>  <p>Art.1361/3</p>	<p>PAG.69 3</p>  <p>Art.1828/21</p>	<p>PAG.176 5.B</p>  <p>Art.GD295/1</p>

HIGHLIGHTS

<p>PAG.54 2.C</p>  <p>Art. 1360/12</p>	<p>PAG.176 5.B</p>  <p>Art. GDS17FB</p>	<p>PAG.251 8.A</p>  <p>Art. 126/A/2</p>
<p>PAG.269 9</p>  <p>Art. GD268/2</p>	<p>PAG.127 4.F</p>  <p>Art. 1150/5</p>	<p>PAG.259 8.B</p>  <p>Art. 1400/1</p>
<p>PAG.161 5.A</p>  <p>Art. GD305/1</p>	<p>PAG.29 1.E</p>  <p>Art. 1374/2/S1</p>	<p>PAG.205 3</p>  <p>Art. 1828/29</p>
<p>PAG.123 4.D</p>  <p>Art. 1688/3</p>	<p>PAG.360 17.A</p>  <p>Art. F085700</p>	<p>PAG.106 4.B</p>  <p>Art. 1730/4</p>
<p>PAG.248 8.A</p>  <p>Art. 1854/9</p>	<p>PAG.168 5.B</p>  <p>Art. GD302/2</p>	<p>PAG.340 15</p>  <p>Art. 136/1</p>

arteferro

SYSTEM

Arteferro System, totally revolutionizes the concept of iron railing. Perfectly suitable for the branches of private, public construction, fully customizable in the design loads 1 kN and 2kN, thanks to the certified newel posts.

Arteferro System, rivoluziona totalmente il concetto di parapetto in ferro. Perfettamente idoneo per i rami dell'edilizia privata, pubblica, totalmente personalizzabile nei carichi di spinta 1 kN e 2kN, grazie al montante certificato.



SAFETY

Tested at **2.5 kN/m** and certified according to the Italian and European regulations.



DESIGN

Over 20 models
Unique and patented design.



EASY TO INSTALL

It reduces by 90% the construction time of the parapet
First modular kit system wrought iron

SICUREZZA

Testato a **2,5 kN/m** e certificato secondo le normative italiane ed europee.

DESIGN

Oltre **20 modelli**
Design unico e depositato.

FACILITÀ DI INSTALLAZIONE

Riduce del 90% i tempi di costruzione di un parapetto
Primo sistema in kit modulare in ferro battuto.



ARTEFERRO SYSTEM IS SUCH AN IMPORTANT PRODUCT THAT IT HAS ITS OWN CATALOG, IF YOU ARE INTERESTED IN DISCOVERING THE WHOLE FAMILY, DOWNLOAD THE SPECIFIC CATALOG OR REQUEST A HARD COPY TO OUR TEAM.

ARTEFERRO SYSTEM È UN PRODOTTO TALMENTE IMPORTANTE CHE SI MERITA UN CATALOGO TUTTO SUO, SE SEI INTERESSATO A CONOSCERE TUTTA LA FAMIGLIA, SCARICA IL CATALOGO SPECIFICO O RICHIEDI LA COPIA CARTACEA AL NOSTRO TEAM.



DOWNLOAD ARTEFERRO SYSTEM





GONZATO

GROUP



A company looking towards the future

Since 1971, **Gonzato Group** is world leader in the production and sale of ornamental components for the building industry and architecture.

All our products are the result of careful and passionate research by qualified experts that know the field better than anyone else. In fact, it is thanks to the Group's work if the production of metal elements for architecture and constructions has been able to grow in terms of technology and project management to become what it is now. The experience acquired in over 40 years of work in the field of wrought iron allowed us to develop in the last 15 years the same deep knowledge in the field of stainless steel and of its fencing applications.

As a matter of fact, our **IAM Design** line, while being more technical and stylized compared to the **Arteferro** components, meets the same needs of safety, support and decoration that we have always well known. In the Group's catalogues you will find more than 30,000 fencing and furniture components always ready to use and ready to be dispatched. Thanks to our long experience, that involves all the production and supply chain from product design to manufacturing, to the installation support, we are the sole company in the world who is able to realize and install anywhere big fencing structures, relying upon our know how and the practical sense of our designers and members of our team.

Un'azienda rivolta al futuro

Gonzato Group è da 50 anni leader mondiale nella produzione e commercializzazione di semilavorati ornamentali per l'edilizia e l'architettura. Tutti i nostri prodotti sono frutto di studi attenti ed appassionati da parte di professionisti specializzati che conoscono il settore meglio di chiunque altro. Infatti è grazie alla attività del Gruppo se la produzione di elementi metallici per l'architettura e l'edilizia ha potuto svilupparsi tecnologicamente e progettualmente fino a diventare quel che è ora. L'esperienza maturata in oltre 40 anni di ferro battuto, ha consentito negli ultimi 15 anni di sviluppare un altrettanto approfondita conoscenza dell'acciaio inox e dei suoi utilizzi nella recinzione.

IAM Design, infatti, propone soluzioni più tecniche e stilizzate, mentre i manufatti in ferro battuto di **Arteferro** hanno caratteristiche di maggiore varietà ornamentale, ma entrambe le linee di prodotti assolvono sempre a quelle stesse esigenze di protezione, sostegno e decorazione che ben conosciamo da sempre. Nei cataloghi del Gruppo sono presenti oltre 30.000 manufatti per recinzioni ed arredamento, sempre pronti all'uso ed alla consegna. Grazie a questa esperienza pluridecennale che coinvolge tutta la filiera dalla produzione siderurgica, al design dei prodotti, alla loro realizzazione, all'installazione dei manufatti, siamo anche gli unici al mondo capaci di ideare con architetti e sviluppatori oltre che di realizzare ovunque grandi opere, forti del know how e della praticità dei nostri progettisti e operatori.



1971

birth
nascita

13

branches
sedi

5

export continents
continenti dove esportiamo

13

subsidiarie
filiali

5

production sites totalling
stabilimenti produttivi

136

export countries
stati dove esportiamo

200

annual projects with business
partners
progetti annui con i partner
commerciali

50+

years of experience
anni di esperienza

2,35 M

tons of metal produced by the
foundation (1971) (equal to 294 times
the weight of the Eiffel Tower)
tonnellate di metallo prodotto dalla
fondazione (1971) (pari a 294 volte
il peso della Torre Eiffel)

+100km

custom railings
every year
parapetti personalizzati
ogni anno

2M

customized semi-finished
products every year
semilavorati personalizzati ogni
anno

1090

EN

14001

ISO

9001

ISO



An ever growing presence.

- 14 branches in 5 continents and headquarter in Italy 5 production sites totalling
- 64.000 Sq. Mt. of warehousing and production
- Over 500 employees (2022)
- 16 Subsidiarie with stocking facilities worldwide
- 4.100 ton./month shipped
- 40 million pieces of ready made components sold per year
- Over 2000 stockist customers served, in 136 different Countries
- Over 32.000 components available on stock
- A 5 continents' leadership
- Exports to 136 countries
- A product range of over 30.000 items

Certifications

Quality certified ISO 9001 Environmental Certification ISO 14001.

Una realtà in continua crescita.

- 14 sedi in 5 continenti con headquarter in Italia 5 stabilimenti produttivi
- 64.000 m2 coperti
- Oltre 500 tra dipendenti e collaboratori (2022)
- 16 filiali con deposito in tutto il mondo
- 4.100 ton./mese spedite
- 40 milioni di semilavorati venduti mediamente in un anno
- Oltre 2000 clienti grossisti in 136 Stati nel mondo;
- Oltre 32.000 articoli diversi a stock
- Leadership nei 5 continenti
- Presenza in 136 stati
- Gamma di oltre 30 mila articoli

Certificazioni

Un sistema di qualità certificato ISO 9001 Certificazione Ambientale ISO 14001.

500

people employed
persone nel gruppo

80%

on stock
a stock

Gonzato Group manufactures and distributes exclusively the products of its brands.

The Arteferro product line includes over 32,000 semi-finished ornamental items made of wrought iron, brass, and bronze: pierced bars, forged pickets, pre-assembled panels, leaves, flowers, baskets, roses, scrolls, rings, and other decorative elements, as well as a rich variety of home furnishings. It is the task of blacksmiths to assemble them into finished objects such as railings, fences, or any other creation suggests his creativity.

The IAM Design product line includes more than 3,300 modular stainless steel elements to achieve railings, fences, canopies, staircases, and other structural elements, both for interior and external spaces. The modern and linear design of the various elements allows a quick and easy installation, and meets the needs of architects, designers and professionals, adapting perfectly to any type of environment.

Gonzato Group produce e distribuisce in esclusiva le realizzazioni dei suoi marchi.

La gamma di prodotti Arteferro comprende oltre 32.000 elementi semilavorati ornamentali in ferro battuto, ottone e bronzo: barre forate, paletti forgiati, pannelli preassemblati, foglie, fiori, pigne, rosoni, ricci, cerchi ed altri elementi decorativi, oltre ad una ricca serie di complementi d'arredo. Sarà compito del fabbro assemblarli in oggetti finiti come parapetti, recinzioni o qualsiasi altra creazione gli suggerisca la sua creatività.

La gamma di prodotti IAM Design comprende oltre 3.300 elementi componibili e modulari in acciaio inox per realizzare parapetti, recinzioni, pensiline, scale ed altri elementi strutturali, per interni ed esterni. Il design moderno e lineare dei vari elementi consente una facile e veloce installazione e soddisfa le esigenze di architetti, progettisti e professionisti adattandosi perfettamente ad ogni tipo di ambiente.



GONZATO
GROUP

arteferro

WM
DESIGN

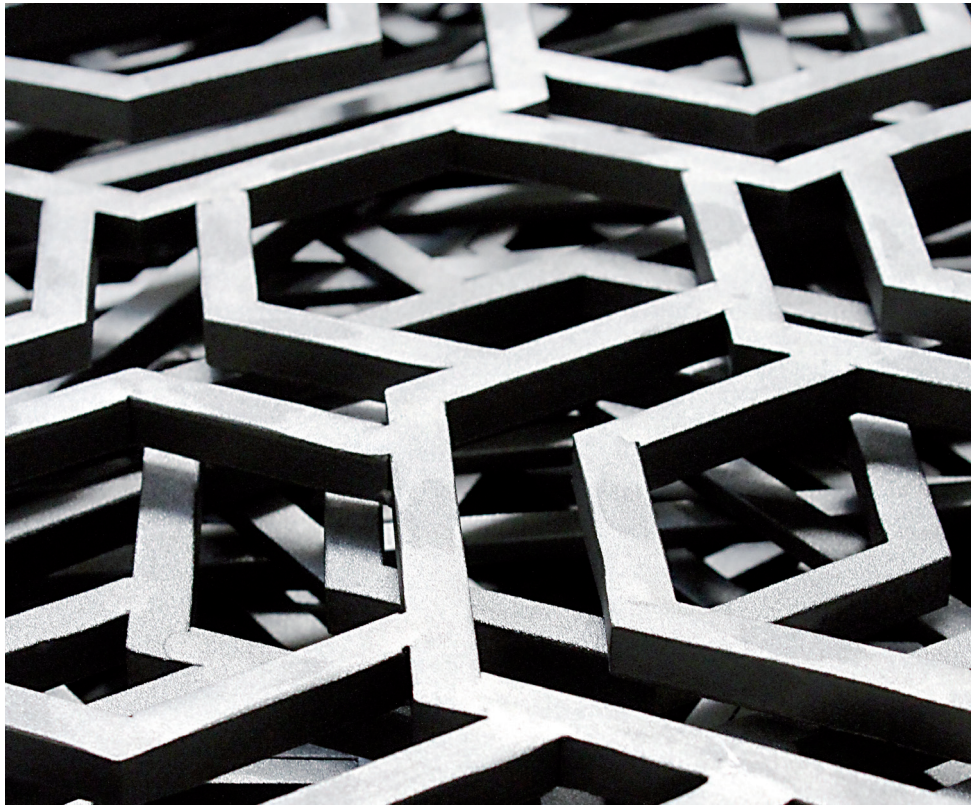

Our turnkey service

Gonzato Group also deals with special turnkey supplies, in wrought iron, stainless steel, or any other metal; for prestigious private homes, public buildings, community spaces and for each kind of commission that requires a custom-made approach all, from the planning to installation. Assisting the customer during all the process, from the first steps to the finished work, Gonzato Group is the ideal partner for any project, placing itself towards the client like the sole responsible of the quality of its product and its service.

I nostri servizi “chiavi in mano”

Gonzato Group si occupa anche di forniture speciali chiavi in mano, in ferro battuto, in acciaio inox o in qualsiasi altro metallo, per prestigiose proprietà private, edifici pubblici, alberghi, spazi comunitari e per ogni tipo di commissione che richieda un approccio custom made, dalla progettazione all'installazione. Affiancando il committente durante tutto il percorso, dai primi passi fino al lavoro finito, Gonzato Group è partner ideale per ogni progetto e si pone nei confronti del cliente come unica responsabile della qualità del proprio prodotto e del servizio offerto.

Production from “i” to “i”

From the i of Idea to the i of Installation, we take care of every aspect of the product.

Unlike many of our competitors, we are real producers thanks to our 5 production branches in Italy and Europe. Unlike most of the products on the market, our items are realized in our production branches in Italy and Europe, thus being submitted to production rules and standard quality tests that allow us to know the story of each piece from its birth to its delivery.

Produzione dalla “i” alla “i”

Dalla “i” di ideazione alla “i” di installazione, ci occupiamo di ogni aspetto del prodotto.

A differenza di molti altri noi siamo davvero produttori con 5 stabilimenti produttivi in Italia ed Europa. Siamo l'unica azienda del settore che può vantare una capacità produttiva in grado di soddisfare ogni richiesta speciale entro brevi tempi di produzione.

I nostri articoli, rispetto alla gran parte dei prodotti che si trovano sul mercato, sono realizzati nei nostri centri produttivi in Italia ed Europa, sottostando a canoni di produzione e a test qualitativi standard, che ci consentono di conoscere la vita di ogni manufatto dalla sua nascita alla sua consegna.



Guaranteed, certified and patented quality

Our articles are produced in our production centers in Italy and in Europe. We can manage the entire production chain ensuring the best final quality. This quality has long been recognized by the certifications obtained ISO 9001 and ISO 14011. A further added value, always as guarantee of originality and quality, it is represented by the patents obtained for many of our items, with the aim to protect both the inventiveness of our designer and the trust of our customers.

Qualità garantita, certificata e brevettata

I nostri articoli vengono realizzati nei nostri centri produttivi in Italia e in Europa. Possiamo quindi gestire tutta la catena di produzione garantendo così la migliore qualità finale. Tale qualità è da anni riconosciuta anche dalle certificazioni ottenute ISO 9001 e ISO 14011. Un ulteriore valore aggiunto, sempre a garanzia di originalità e qualità, è rappresentato dai brevetti registrati per molti dei nostri articoli, con lo scopo di tutelare sia l'ingegno dei nostri designer sia la fiducia dei nostri clienti.



An excellence customer service

Our back-office staff is fluent in five languages and is on hand to give you all the information and support you need.

Un servizio clienti d'eccellenza

Il nostro staff di back office parla fluentemente cinque lingue diverse ed è a vostra disposizione per darvi tutte le informazioni ed il supporto che vi servono.



A marketing department at your disposal

Our marketing department is on hand to organize activities and to develop promotional materials personalized with the customer's logo. For years now we make flyers and catalogs tailored to our customers.

Un ufficio marketing a tua disposizione

Il nostro ufficio marketing è a disposizione per organizzare attività ed elaborare materiale promozionale personalizzato con il logo del cliente. Da anni ormai realizziamo volantini e cataloghi ad hoc per i nostri clienti più affezionati.



Educational

With our specialized staff, we organize meetings of technical training: all you need to know to design and install parapets, railings, stairs and other structural elements in accordance with law.

Formazione

Con il nostro personale specializzato, organizziamo incontri di formazione tecnica: tutto ciò che bisogna sapere per progettare ed installare parapetti, cancellate, scale ed altri elementi strutturali a norma di legge.



Arteferro products in the catalogue can be produced in brass, aluminum or steel. Also custom-made.

I prodotti Arteferro presenti a catalogo possono essere prodotti in ottone, alluminio o acciaio. Anche su misura



Long bars

Barre lunghe

Arteferro long bars are variously shaped metal bars, used for a multitude of applications: along a staircase or wall where a support is needed, or as a structural part of a gate or fence. Using both hot and cold processes, they are available in lengths of 3 and 6 metres, with square, rectangular or round sections. To complete the section, there's a wide range of fittings, joints and clamps for tightening of decorative elements.

Le barre lunghe Arteferro sono barre di metallo ariamente sagomate, si usano in una moltitudine di applicazioni: lungo una scala od una parete in cui sia necessario un appoggio, come parte strutturale di un cancello o di una recinzione. Con lavorazioni sia a caldo che a freddo sono disponibili nelle lunghezze da 3 e 6 metri, con sezioni quadre, rettangolari o tonde. A completare il capitolo, la vasta gamma di partenze, giunzioni e fascette per il serraggio di elementi decorativi.

arteferro



Long Bars - Barre lunghe

A Plain bars	Barre lisce	pag.21
B Decorative round bars	Tondi lavorati	pag.23
C Decorative square bars	Quadri lavorati	pag.24
D Decorative flat bars	Piatti lavorati.....	pag.26
E Hammered edges tubes	Tubi lavorati.....	pag.28
F Handrails and end pieces	Corrimani e Partenze.....	pag.30
G Twisted pickets	Torciglioni	pag.40
H Collars	Fascette	pag.42

**Choose the section!
Identifying the finish is
very easy**

**Parti dalla sezione!
individuare la finitura
sarà un gioco da ragazzi**



Choose the item,
add "/Z" to order the
galvanized version

Scegli l'articolo,
aggiungi "/Z" per ordinare
la versione zincata a
freddo

7000 t

of bars and handrails
manufactured each month
in our forges

di barre e corrimani
vengono forgiate ogni mese
nelle nostre fucine

Example - Esempio

1368/23/6000/Z

= galvanized version
= versione zincata a freddo

HOT ROLLED ROUND AND SQUARE PLAIN BARS TONDI E QUADRI LISCI LAMINATI A CALDO



Section Sezione	Length Lunghezza	Plain Liscio Art.
Ø 6 mm	3000 mm	1368/6
	6000 mm	1368/6/6000
Ø 8 mm	3000 mm	1368/7
	6000 mm	1368/7/6000
Ø 10 mm	3000 mm	1368/8
	6000 mm	1368/8/6000
Ø 12 mm	3000 mm	1368/9
	6000 mm	1368/9/6000
Ø 14 mm	3000 mm	1368/10
	6000 mm	1368/10/6000
Ø 16 mm	3000 mm	-
	6000 mm	1368/23/6000
Ø 18 mm	3000 mm	1368/24
	6000 mm	1368/24/6000
Ø 20 mm	3000 mm	1368/25
	6000 mm	1368/25/6000
Ø 22 mm	3000 mm	1368/32
	6000 mm	1368/32/6000
Ø 25 mm	3000 mm	1368/25/S
	6000 mm	1368/25/S/6000
Ø 30 mm	3000 mm	1368/35
	6000 mm	1368/35/6000

Section Sezione	Plain Liscio Art.
6 x 6 mm	1368/1
	1368/1/6000
7 x 7 mm	1368/27
	1368/27/6000
8 x 8 mm	1368/2
	1368/2/6000
10 x 10 mm	1368/3
	1368/3/6000
12 x 12 mm	1368/4
	1368/4/6000
14 x 14 mm	1368/5
	1368/5/6000
16 x 16 mm	1368/20
	1368/20/6000
18 x 18 mm	1368/21
	1368/21/6000
20 x 20 mm	-
	1368/22/6000
22 x 22 mm	1368/28
	1368/28/6000
25 x 25 mm	1368/26
	1368/26/6000
30 x 30 mm	1368/22/S
	1368/22/S/6000
35 x 35 mm	1368/29
	1368/29/6000
40 x 40 mm	1368/30
	1368/30/6000
50 x 50 mm	1368/31
	1368/31/6000



HOT ROLLED FLAT BARS - PIATTI LAMINATI A CALDO



Section Sezione	Length Lunghezza Art.	Plain Liscio Art.
10 x 5 mm	3000 mm	-
	6000 mm	1368/11/6000
12 x 4 mm	3000 mm	1368/37
	6000 mm	1368/37/6000
12 x 6 mm	3000 mm	1368/12
	6000 mm	1368/12/6000
12 x 8 mm	3000 mm	1368/39
	6000 mm	1368/39/6000
14 x 6 mm	3000 mm	1368/41
	6000 mm	1368/41/6000
14 x 8 mm	3000 mm	1368/13
	6000 mm	1368/13/6000
16 x 6 mm	3000 mm	1368/43
	6000 mm	1368/43/6000
16 x 8 mm	3000 mm	1368/44
	6000 mm	1368/44/6000
16 x 10 mm	3000 mm	1368/45
	6000 mm	1368/45/6000
20 x 3 mm	3000 mm	1368/46
	6000 mm	1368/46/6000
20 x 4 mm	3000 mm	1368/15
	6000 mm	1368/15/6000
20 x 5 mm	3000 mm	1368/47
	6000 mm	1368/47/6000
20 x 6 mm	3000 mm	1368/16
	6000 mm	1368/16/6000
20 x 8 mm	3000 mm	1368/48
	6000 mm	1368/48/6000
20 x 10 mm	3000 mm	1368/49
	6000 mm	1368/49/6000
20 x 15 mm	3000 mm	1368/50
	6000 mm	1368/50/6000
25 x 4 mm	3000 mm	1368/17
	6000 mm	1368/17/6000
25 x 5 mm	3000 mm	1368/52
	6000 mm	1368/52/6000
25 x 6 mm	3000 mm	1368/53
	6000 mm	1368/53/6000
25 x 8 mm	3000 mm	1368/54
	6000 mm	1368/54/6000
25 x 10 mm	3000 mm	1368/55
	6000 mm	1368/55/6000
30 x 5 mm	3000 mm	1368/57
	6000 mm	1368/57/6000
30 x 6 mm	3000 mm	1368/58
	6000 mm	1368/58/6000
30 x 8 mm	3000 mm	1368/18
	6000 mm	1368/18/6000
30 x 10 mm	3000 mm	1368/59
	6000 mm	1368/59/6000
30 x 12 mm	3000 mm	1368/60
	6000 mm	1368/60/6000

Section Sezione	Length Lunghezza Art.	Plain Liscio Art.
30 x 15 mm	3000 mm	1368/61
	6000 mm	1368/61/6000
30 x 20 mm	3000 mm	1368/62
	6000 mm	1368/62/6000
35 x 4 mm	3000 mm	1368/63
	6000 mm	1368/63/6000
35 x 5 mm	3000 mm	1368/64
	6000 mm	1368/64/6000
35 x 6 mm	3000 mm	1368/65
	6000 mm	1368/65/6000
35 x 8 mm	3000 mm	1368/66
	6000 mm	1368/66/6000
35 x 10 mm	3000 mm	1368/67
	6000 mm	1368/67/6000
35 x 15 mm	3000 mm	1368/69
	6000 mm	1368/69/6000
40 x 4 mm	3000 mm	1368/70
	6000 mm	1368/70/6000
40 x 5 mm	3000 mm	1368/71
	6000 mm	1368/71/6000
40 x 6 mm	3000 mm	1368/72
	6000 mm	1368/72/6000
40 x 8 mm	3000 mm	1368/19
	6000 mm	1368/19/6000
40 x 10 mm	3000 mm	1368/73
	6000 mm	1368/73/6000
40 x 12 mm	3000 mm	1368/74
	6000 mm	1368/74/6000
40 x 20 mm	3000 mm	1368/76
	6000 mm	1368/76/6000
45 x 6 mm	3000 mm	1368/77
	6000 mm	1368/77/6000
45 x 8 mm	3000 mm	1368/78
	6000 mm	1368/78/6000
45 x 10 mm	3000 mm	1368/79
	6000 mm	1368/79/6000
45 x 20 mm	3000 mm	1368/81
	6000 mm	1368/81/6000
50 x 3 mm	3000 mm	1368/82
	6000 mm	1368/82/6000
50 x 4 mm	3000 mm	1368/83
	6000 mm	1368/83/6000
50 x 6 mm	3000 mm	1368/84
	6000 mm	1368/84/6000
50 x 8 mm	3000 mm	1368/85
	6000 mm	1368/85/6000
50 x 10 mm	3000 mm	1368/86
	6000 mm	1368/86/6000
50 x 20 mm	3000 mm	1368/88
	6000 mm	1368/88/6000
60 x 4 mm	3000 mm	1368/90
	6000 mm	1368/90/6000

Section Sezione	Length Lunghezza Art.	Plain Liscio Art.
60 x 6 mm	3000 mm	1368/91
	6000 mm	1368/91/6000
60 x 8 mm	3000 mm	1368/92
	6000 mm	1368/92/6000
60 x 10 mm	3000 mm	1368/93
	6000 mm	1368/93/6000
60 x 12 mm	3000 mm	1368/94
	6000 mm	1368/94/6000
60 x 20 mm	3000 mm	1368/95
	6000 mm	1368/95/6000
70 x 5 mm	3000 mm	1368/96
	6000 mm	1368/96/6000
70 x 6 mm	3000 mm	1368/97
	6000 mm	1368/97/6000
70 x 8 mm	3000 mm	1368/98
	6000 mm	1368/98/6000
80 x 8 mm	3000 mm	1368/99
	6000 mm	1368/99/6000
90 x 4 mm	3000 mm	1368/100
	6000 mm	1368/100/6000
90 x 5 mm	3000 mm	1368/101
	6000 mm	1368/101/6000
100 x 8 mm	3000 mm	1368/102
	6000 mm	1368/102/6000
120 x 8 mm	3000 mm	1368/103
	6000 mm	1368/103/6000



COLD PROCESSED - LAVORATI A FREDDO



Section Sezione	Length Lunghezza	Mech. hammering Lav. meccanica Grapevine effect Tralcio vite Art.	Mech. hammering Lav. meccanica Bark effect Corteccia Art.	Mech. hammering Lav. meccanica Power long hammering Magliatura piatta allungata Art.	Power hammering Lav. manuale Power hammered Magliato Art.	Power hammering Lav. manuale Hammered Battuto Art.
6 mm	3000 mm	-	-	-	-	600/1
	6000 mm	-	-	-	-	-
8 mm	3000 mm	598/11	599/1	598/9	-	600/2
10 mm	3000 mm	598/12	599/2	-	-	600/3
	6000 mm	-	599/2/6000	-	-	600/3/6000
12 mm	3000 mm	-	599/3	598/1	-	600/4
	6000 mm	-	599/3/6000	-	-	600/4/6000
14 mm	3000 mm	598/14	599/4	598/2	-	600/5
	6000 mm	-	-	-	-	-
16 mm	3000 mm	-	599/5	598/3	-	600/6
	6000 mm	-	599/5/6000	-	-	-
18 mm	3000 mm	598/16	599/6	598/4	-	600/7
	6000 mm	-	599/6/6000	-	-	600/7/6000
20 mm	3000 mm	-	599/7	598/5	118/A/13	600/8
	6000 mm	-	599/7/6000	-	-	600/8/6000
22 mm	3000 mm	598/18	-	-	-	600/9
	6000 mm	-	-	-	-	600/9/6000
24 mm	3000 mm	-	599/9	-	-	-
	6000 mm	-	599/9/6000	-	-	-
25 mm	3000 mm	-	-	598/6	-	-
	6000 mm	-	-	-	-	-
30 mm	3000 mm	-	-	598/7	118/A/15	-
	6000 mm	-	-	-	-	-
40 mm	3000 mm	-	-	598/8	-	-



COLD PROCESSED - LAVORATI A FREDDO



Section Sezione	Length Lunghezza	Mech. hammering Lav. meccanica Hammered 4 edges Battuto 4 spigoli	Mech. hammering Lav. meccanica Ham. 4 sides and 4 edges Battuto 4 lati e 4 spigoli	Mech. hammering Lav. meccanica Hammered 4 sides Battuto 4 lati	Mech. hammering Lav. meccanica Hammered 4 sides Battuto 4 lati	Mech. hammering Lav. meccanica Flat beveled 4 edges Smuss. piana 4 spigoli	Mech. hammering Lav. meccanica Notched 2 sides Tachettato 2 lati	Mech. hammering Lav. meccanica Diamond 2 sides Diamantato 2 lati
		Art.	Art.	Art.	Art.	Art.	Art.	Art.
8 x 8 mm	3000 mm	-	-	-	-	-	-	-
10 x 10 mm	3000 mm	-	-	-	-	-	-	-
	6000 mm	118/1/Q10/6000	-	-	-	-	-	-
12 x 12 mm	3000 mm	118/1	118/A/1	1841/1	-	-	-	-
	6000 mm	118/1/6000	118/A/1/6000	-	-	GD124/25	-	1370/13/6000
14 x 14 mm	3000 mm	118/2	118/A/2	1841/2	-	-	-	1370/14
	6000 mm	118/2/6000	-	-	-	GD124/26	-	1370/14/6000
16 x 16 mm	3000 mm	118/3	118/A/3	1841/3	1841/32	GD124/19	-	-
	6000 mm	118/3/6000	118/A/3/6000	-	-	GD124/27	-	-
18 x 18 mm	3000 mm	118/4	118/A/4	-	-	GD124/20	-	-
	6000 mm	118/4/6000	118/A/4/6000	-	-	GD124/28	-	-
20 x 20 mm	3000 mm	118/5	118/A/5	-	1841/34	GD124/21	-	-
	6000 mm	118/5/6000	118/A/5/6000	-	-	-	-	-
25 x 25 mm	3000 mm	118/6	180/53	-	-	GD124/23	-	-
	6000 mm	118/6/6000	180/53/6000	-	-	GD124/31	-	-
30 x 30 mm	3000 mm	118/24	180/50	-	-	GD124/24	-	-
	6000 mm	118/24/6000	180/50/6000	-	-	GD124/32	-	-
40 x 40 mm	3000 mm	118/25	180/54	-	-	-	-	-
	6000 mm	118/25/6000	180/54/6000	-	-	-	-	-



COLD PROCESSED - LAVORATI A FREDDO



Section Sezione	Length Lunghezza	Mech. hammering Lav. meccanica Hammered 4 sides Martellato 4 lati Art.	Mech. hammering Lav. meccanica Bark effect 4 sides Corteccia 4 lati Art.	Mech. hammering Lav. meccanica Four-leaf clover Quadrifoglio Art.	Mech. hammering Lav. meccanica Grooved 4 sides Rigato 4 lati Art.	Mech. hammering Lav. meccanica Grooved and hamm. 4 sides Rigato e spigolato 4 lati Art.	Mech. hammering Lav. meccanica Multiline 4 sides Multiriga 4 lati Art.	Mech. hammering Lav. meccanica Irregular beveled 4 corners Smuss. irregolare 4 angoli Art.
8 x 8 mm	3000 mm	118/15	-	-	-	-	-	-
	6000 mm	118/15/6000	-	-	-	-	-	-
10 x 10 mm	3000 mm	118/16	623/4	626/10	-	-	-	-
	6000 mm	118/16/6000	623/4/6000	626/10/6000	-	-	-	-
12 x 12 mm	3000 mm	118/17	623/5	-	625/3	-	-	-
	6000 mm	118/17/6000	623/5/6000	-	625/3/6000	-	-	-
14 x 14 mm	3000 mm	118/18	-	626/12	625/4	-	-	-
	6000 mm	118/18/6000	623/6/6000	626/12/6000	-	-	-	-
16 x 16 mm	3000 mm	118/19	623/7	-	625/5	625/9	-	-
	6000 mm	118/19/6000	623/7/6000	-	625/5/6000	-	-	-
17 x 17 mm	3000 mm	-	-	626/14	-	-	-	-
	6000 mm	-	-	626/14/6000	-	-	-	-
18 x 18 mm	3000 mm	118/20	623/8	626/15	625/6	-	-	-
	6000 mm	118/20/6000	623/8/6000	626/15/6000	-	-	-	-
20 x 20 mm	3000 mm	118/21	623/9	-	-	-	-	-
	6000 mm	-	623/9/6000	-	-	-	-	-
23 x 23 mm	3000 mm	-	-	626/16	-	-	-	-
	6000 mm	-	-	626/16/6000	-	-	-	-
24 x 24 mm	3000 mm	-	623/11	-	-	-	-	-
	6000 mm	-	623/11/6000	-	-	-	-	-
25 x 25 mm	3000 mm	118/22	-	-	-	-	-	-
	6000 mm	118/22/6000	-	-	-	-	-	GD124/33
30 x 30 mm	3000 mm	118/23	-	-	1806/3	-	1806/9	-
	6000 mm	118/23/6000	-	-	1806/6	-	1806/12	-
40 x 40 mm	3000 mm	-	-	-	-	-	1806/8	-
	6000 mm	-	-	-	1806/5	-	1806/11	GD124/34
50 x 50 mm	3000 mm	-	-	-	-	-	1806/7	-
	6000 mm	-	-	-	1806/4	-	1806/10	GD124/35

Items
GD124/33, 34
and 35 were used
to create
the new features
of the Colosseum in Rome.

Gli articoli GD124/33, 34
e 35 sono stati utilizzati
per la realizzazione
delle nuove cancellate
del Colosseo a Roma.

Arteferro
products
can be manufactured
as well as customised.

I prodotti Arteferro
sono realizzabili
anche su misura.

COLD PROCESSED - LAVORATI A FREDDO



Section Sezione	Length Lunghezza	Mech. hammering Lav. meccanica	Mech. hammering Lav. meccanica	Mech. hammering Lav. meccanica	Mech. hammering Lav. meccanica	Mech. hammering Lav. meccanica
		Hammered 2 edges Spigolato 2 spigoli	Hammered 4 edges Spigolato 4 spigoli	Diamond 2 small sides Diamantato 2 lati piccoli	Grooved 2 small sides Rigato 2 lati piccoli	Notched 2 small sides Tachettato 2 lati piccoli
		Art.	Art.	Art.	Art.	Art.
∅ 12 x 6 mm	3000 mm	-	1839/21	623/1	-	-
	6000 mm	-	1839/21/6000	623/1/6000	-	622/1/6000
∅ 14 x 6 mm	3000 mm	-	1839/22	623/3	-	622/6
	6000 mm	-	1839/22/6000	623/3/6000	-	622/6/6000
∅ 14 x 8 mm	3000 mm	-	1839/23	623/12	-	622/3
	6000 mm	-	1839/23/6000	623/12/6000	1369/1/6000	622/3/6000
∅ 16 x 6 mm	3000 mm	-	1839/26	623/2	-	622/4
	6000 mm	-	1839/26/6000	623/2/6000	-	622/4/6000
∅ 16 x 8 mm	3000 mm	-	1839/24	-	1369/2	-
	6000 mm	-	1839/24/6000	-	1369/2/6000	622/5/6000
∅ 20 x 6 mm	3000 mm	-	-	-	-	622/4/S
	6000 mm	118/7/20X6/6000	1839/15/S/L6	-	-	622/4/S/6000
∅ 20 x 8 mm	3000 mm	118/7	118/7/S1	-	-	-
	6000 mm	118/7/6000	118/7/S1/6000	-	-	-
∅ 20 x 10 mm	3000 mm	-	118/7/S	-	-	-
	6000 mm	-	118/7/S/6000	-	-	-
∅ 25 x 6 mm	3000 mm	1838/5	1839/15	-	-	-
	6000 mm	1838/5/6000	1839/15/6000	-	-	-
∅ 25 x 8 mm	3000 mm	118/8	1839/16	-	-	-
	6000 mm	118/8/6000	1839/16/6000	-	-	-
∅ 25 x 10 mm	3000 mm	1838/6	118/8/S1	-	-	-
	6000 mm	1838/6/6000	118/8/S1/6000	-	-	-
∅ 30 x 6 mm	3000 mm	1838/7	1839/17	-	-	-
	6000 mm	1838/7/6000	1839/17/6000	-	-	-
∅ 30 x 8 mm	3000 mm	114/9	1839/18	-	-	-
	6000 mm	114/9/6000	1839/18/6000	-	-	-
∅ 30 x 10 mm	3000 mm	114/9/S2	118/9/S1	-	-	-
	6000 mm	118/9/S/6000	118/9/S1/6000	-	-	-
∅ 30 x 12 mm	3000 mm	-	1839/18/S	-	-	-
	6000 mm	-	1839/18/S6000	-	-	-
∅ 30 x 15 mm	3000 mm	-	1839/1	-	-	-
	6000 mm	-	1839/1/6000	-	-	-
∅ 30 x 20 mm	3000 mm	-	1839/2	-	-	-
	6000 mm	-	1839/2/6000	-	-	-
∅ 35 x 8 mm	3000 mm	114/9/35X8	-	-	-	-
	6000 mm	114/9/35X8/6000	1839/18/S2	-	-	-
∅ 35 x 10 mm	3000 mm	-	-	-	-	-
	6000 mm	-	1839/18/S4	-	-	-
∅ 40 x 6 mm	3000 mm	1838/2/S/3000	-	-	-	-
	6000 mm	1838/2/S/6000	1839/19/6000	-	-	-
∅ 40 x 8 mm	3000 mm	1838/2	1839/20	-	-	-
	6000 mm	1838/2/6000	1839/20/6000	-	-	-
∅ 40 x 10 mm	3000 mm	1838/2/S1	1839/20/S3	-	-	-
	6000 mm	1838/2/S1/6000	1839/20/S3/6000	-	-	-
∅ 40 x 15 mm	3000 mm	-	1839/3	-	-	-
	6000 mm	-	1839/4	-	-	-
∅ 40 x 20 mm	3000 mm	-	1839/4/6000	-	-	-
	6000 mm	-	1839/4/6000	-	-	-
∅ 50 x 6 mm	3000 mm	1838/3/S7	1839/19/50X6	-	-	-
	6000 mm	1838/3/S6	-	-	-	-
∅ 50 x 8 mm	3000 mm	1838/3	1838/3/S1	-	-	-
	6000 mm	1838/3/6000	1838/3/S2	-	-	-
∅ 50 x 10 mm	3000 mm	1838/3/S5	1839/20/S4	-	-	-
	6000 mm	1838/3/S4	1839/20/S6000	-	-	-
∅ 60 x 6 mm	3000 mm	1838/4/S1	-	-	-	-
	6000 mm	1838/4/S1/L6	-	-	-	-
∅ 60 x 8 mm	3000 mm	1838/4	1839/20/S1	-	-	-
	6000 mm	1838/4/6000	1839/20/S2	-	-	-

COLD PROCESSED - LAVORATI A FREDDO



Section Sezione	Length Lunghezza	Mech. hammering Lav. meccanica	Mech. hammering Lav. meccanica	Mech. hammering Lav. meccanica	Mech. hammering Lav. meccanica	Mech. hammering Lav. meccanica
		Hammered 2 wide sides Martellato 2 lati larghi	Hamm. 2 sides and 4 edges Battuto 2 lati e 4 spigoli	Hammered 2 sides Battuto 2 lati	Hammered 2 sides and 4 edges Martellato 2 lati e 4 spigoli	Hammered 1 side and 2 edges Battuto 1 lato e 2 spigoli
		Art.	Art.	Art.	Art.	Art.
☒ 16 x 4 mm	3000 mm	118/10	-	-	-	-
	6000 mm	-	-	-	-	-
☒ 20 x 4 mm	3000 mm	118/11	-	-	-	-
	6000 mm	118/11/6000	-	-	-	-
☒ 20 x 6 mm	3000 mm	118/12	-	-	-	-
	6000 mm	118/12/6000	-	-	-	-
☒ 20 x 8 mm	3000 mm	118/26	-	-	-	-
	6000 mm	-	-	-	-	-
☒ 25 x 8 mm	3000 mm	118/28	-	-	-	-
	6000 mm	118/28/6000	-	-	-	-
☒ 30 x 6 mm	3000 mm	-	118/A/6/SS	1839/7	1839/11	-
	6000 mm	-	118/A/6/S/L6	1839/7/6000	1839/11/6000	-
☒ 30 x 8 mm	3000 mm	118/13	118/A/6	1839/8	-	-
	6000 mm	118/13/6000	118/A/6/6000	1839/8/6000	1839/12/6000	-
☒ 30 x 10 mm	3000 mm	-	118/A/7	-	-	-
	6000 mm	-	118/A/7/6000	-	-	-
☒ 30 x 15 mm	3000 mm	-	118/A/8	-	-	-
	6000 mm	-	118/A/8/6000	-	-	-
☒ 30 x 20 mm	3000 mm	180/51	118/A/9	-	-	-
	6000 mm	-	118/A/9/6000	-	-	-
☒ 40 x 6 mm	3000 mm	-	-	1839/9	1839/13	1839/5
	6000 mm	-	-	1839/9/6000	1839/13/6000	1839/5/6000
☒ 40 x 8 mm	3000 mm	118/14	118/A/6/S	1839/10	1839/14	1839/6
	6000 mm	118/14/6000	118/A/6/S/6000	1839/10/6000	1839/14/6000	1839/6/6000
☒ 40 x 10 mm	3000 mm	118/14/S2	-	-	-	-
	6000 mm	-	-	-	-	-
☒ 40 x 20 mm	3000 mm	-	118/A/9/S	-	-	-
	6000 mm	-	118/A/9/S/6000	-	-	-
☒ 50 x 4 mm	3000 mm	118/30	-	-	-	-
	6000 mm	-	-	-	-	-
☒ 50 x 8 mm	3000 mm	-	118/A/6/50X8	-	-	-
	6000 mm	-	118/A/6/50X8/6000	-	-	-



SQUARE TUBES WITH SHORT HAMMERING ON EDGES TUBI QUADRATI CON MARTELLATURA CORTA SUGLI SPIGOLI



Short hammering
Martellatura corta

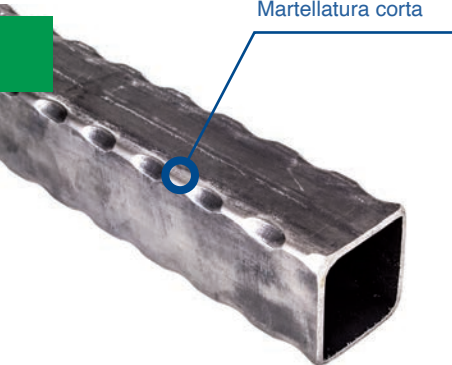

Section Sezione	Thickness Spessore	L 3000 mm		L 6000 mm	
		Art.	Art.	Art.	Art.
□ 12 x 12 mm	1 mm	1374/21	-	-	-
□ 12 x 12 mm	1,5 mm	1374/26	-	1374/27	-
□ 16 x 16 mm	1 mm	-	-	1374/20	-
□ 16 x 16 mm	1,5 mm	1374/25	-	1374/24	-
□ 20 x 20 mm	2,5 mm	1374/1	-	118/E/1	-
□ 25 x 25 mm	2,5 mm	1374/2	-	118/E/9	-
□ 30 x 30 mm	2,5 mm	1374/3	-	118/E/3	-
□ 35 x 35 mm	2,5 mm	1374/23	-	-	-
□ 40 x 40 mm	2,5 mm	1374/4	-	118/E/5	-
□ 50 x 50 mm	2,5 mm	1374/5	-	1374/15	-
□ 60 x 60 mm	2,5 mm	-	-	118/E/13	-
□ 80 x 80 mm	2,7 mm	1374/6	-	1374/16	-
□ 100 x 100 mm	2,7 mm	1374/7	-	1374/17	-
□ 120 x 120 mm	2,7 mm	1374/8	-	1374/18	-

Choose the item,
add "/Z" to order the
galvanized version

Scegli l'articolo,
aggiungi "/Z" per ordinare
la versione zincata a
freddo

RECTANGULAR TUBES WITH SHORT HAMMERING ON EDGES TUBI RETTANGOLARI CON MARTELLATURA CORTA SUGLI SPIGOLI

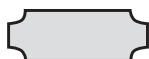

Short hammering
Martellatura corta



Section Sezione	Thickness Spessore	L 3000 mm		L 6000 mm	
		Art.	Art.	Art.	Art.
▧ 30 x 20 mm	2,5 mm	1374/9	-	118/E/2	-
▧ 40 x 20 mm	2,5 mm	1374/10	-	118/E/4	-
▧ 40 x 30 mm	2,5 mm	1374/10/S4	-	118/E/19	-
▧ 50 x 30 mm	2,5 mm	1374/11	-	118/E/6	-
▧ 50 x 40 mm	2,5 mm	1374/11/S5	-	118/E/14	-
▧ 60 x 30 mm	2,5 mm	1374/12	-	118/E/7	-
▧ 60 x 40 mm	2,5 mm	1374/29	-	118/E/15	-
▧ 80 x 40 mm	2,7 mm	1374/13	-	118/E/8	-
▧ 80 x 60 mm	2,7 mm	-	-	118/E/8/S1	-
▧ 100 x 40 mm	2,7 mm	1374/14	-	118/E/10	-
▧ 100 x 50 mm	2,7 mm	-	-	118/E/17	-
▧ 120 x 40 mm	2,7 mm	-	-	118/E/12	-

SQUARE TUBES WITH LONG HAMMERING ON EDGES TUBI QUADRATI CON MARTELLATURA ALLUNGATA SUGLI SPIGOLI

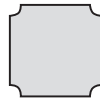
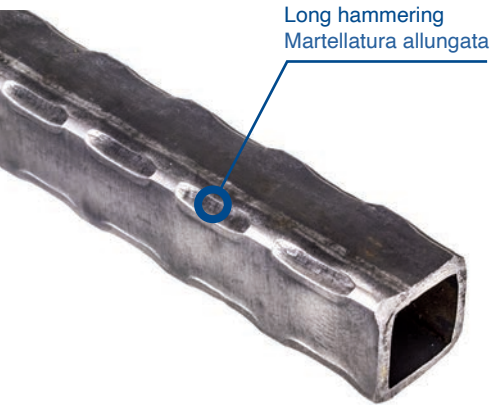

Section Sezione	Thickness Spessore	L 3000 mm	L 6000 mm
		Art.	Art.
□ 25 x 25 mm	2,5 mm	1374/2/S1	118/E/9/S1
□ 30 x 30 mm	2,5 mm	1374/3/S2	118/E/3/S4
□ 30 x 30 mm	2 mm	1374/3/S4	118/E/3/S5
□ 40 x 40 mm	2,5 mm	1374/4/S1	118/E/5/S3

BEST PRICE

RECTANGULAR TUBES WITH LONG HAMMERING ON EDGES TUBI RETTANGOLARI CON MARTELLATURA ALLUNGATA SUGLI SPIGOLI

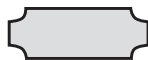

Section Sezione	Thickness Spessore	L 3000 mm	L 6000 mm
		Art.	Art.
▧ 30 x 20 mm	1,5 mm	1374/9/S	-
▧ 30 x 20 mm	2,5 mm	-	118/E/2/S1
▧ 40 x 20 mm	2,5 mm	1374/10/S2	118/E/4/S2
▧ 40 x 20 mm	2 mm	-	118/E/4/S4
▧ 40 x 30 mm	2,5 mm	1374/10/S3	118/E/4/S3
▧ 50 x 40 mm	2 mm	1374/11/S3	118/E/6/S3
▧ 60 x 30 mm	2,5 mm	1374/12/S2	118/E/7/S3
▧ 60 x 40 mm	2,5 mm	-	118/E/16

Hot hammered - Coniata a caldo

Arteferro bars are produced by paying attention to detail and cut at the ends
Le barre Arteferro sono curate in ogni dettaglio ed anche rifilate alle estremità.

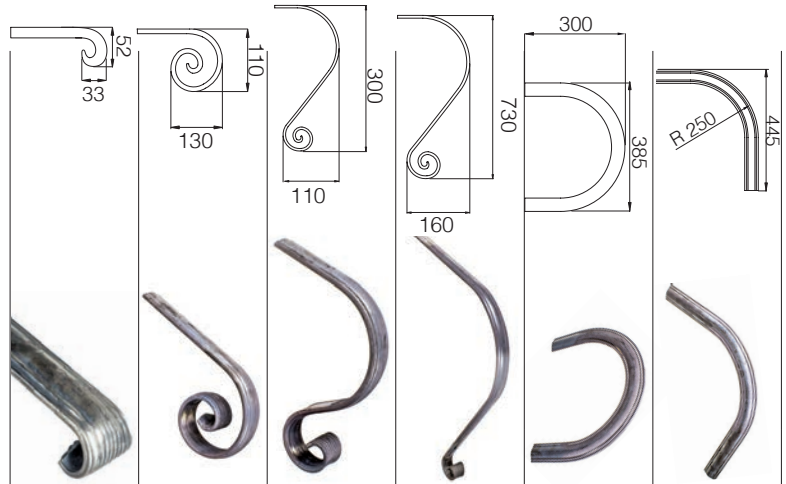

	L 3000 mm	L 6000 mm	Section Sezione	Art.	Art.	Art.	Art.	Art.	Art.	Art.
	Art.	Art.								
	1373/4	1373/4/6000	40 x 11 mm	1817/9/S5	1817/9	1817/5	1817/1	1822/2	1822/13	
	1373/3	1373/3/6000	45 x 12 mm	-	1377/24	1377/11	1817/2	1822/3	1822/14	
	114/A/3	114/A/3/6000	50 x 14 mm	114/B/13/S9	114/B/13	114/B/14	114/B/15	1822/1	1822/12	
	1373/2	1373/2/6000	60 x 16 mm	-	1377/23	1817/8	1817/3	-	1822/15	

	L 4000 mm		Section Sezione	Art.	Art.	Art.	Art.	Art.	Art.	Art.
	Art.	Art.								
	811/2	-	58 x 16 mm	-	-	1817/7	1817/4	1822/6	1817/7	

	L 3000 mm L 6000 mm		Section Sezione	Art.	Art.	Art.	Art.	Art.	Art.	Art.
	Art.	Art.								
	-	-	A49 x B19 x C28 mm	-	812/15	1377/42	-	-	-	
	811/3	811/6	A56 x B21 x C32,5 mm	812/12/S	812/12	1377/40	1819/10	-	-	

	L 3000 mm L 6000 mm		Section Sezione	Art.	Art.	Art.	Art.	Art.	Art.	Art.
	Art.	Art.								
	810/B/19	-	44 x 14 mm	-	1377/18	1377/5	1819/5	-	-	

	L 3650 mm		Section Sezione	Art.	Art.	Art.	Art.	Art.	Art.	Art.
	Art.	Art.								
	114/A/1	-	43 x 7 mm	-	1818/15	114/B/1	1818/5	1822/7	1822/18	

Tapered manually forged
 Rastremato forgiato manualmente

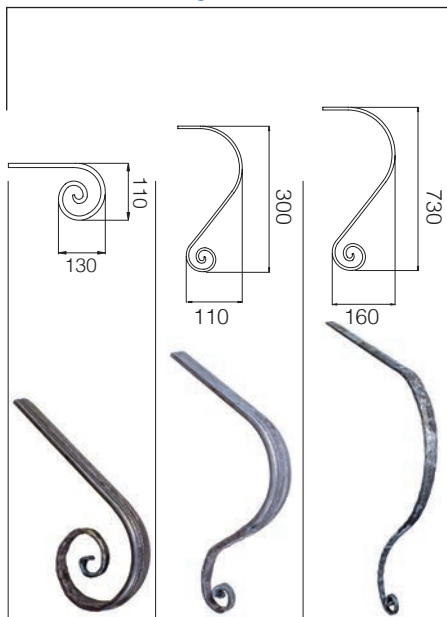

Section
 Sezione

	Art.	Art.	Art.
∅ 40 x 11 mm	1814/17	1814/11	1814/5
∅ 45 x 12 mm	1814/16	1814/10	1814/4
∅ 50 x 14 mm	1814/18	1814/12	1814/6
∅ 60 x 16 mm	1814/15	1814/9	1814/3

The end piece of a handrail is a highly characterising element. Don't allow the processing and beauty of your handrail get spoiled by an unsightly welding between the end and the long bar. The extendable ends resolve this problem: starting with 3 meters rails, we can create the end you need.

La partenza di un corrimano è un elemento altamente caratterizzante. Non lasciare che la lavorazione e la bellezza del tuo corrimano venga interrotta da una antiestetica saldatura tra la partenza e la barra lunga. Le partenze allungate risolvono questo problema: partendo da una barra di 3 metri realizzeremo la partenza che ti serve.

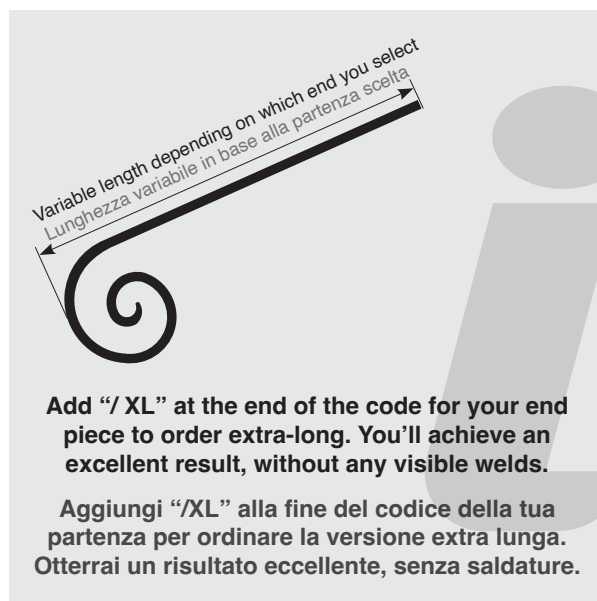

Add "/XL" at the end of the code for your end piece to order extra-long. You'll achieve an excellent result, without any visible welds.

Aggiungi "/XL" alla fine del codice della tua partenza per ordinare la versione extra lunga. Otterrai un risultato eccellente, senza saldature.

Example - Esempio

1817/9/XL = Extended version
 = Versione allungata

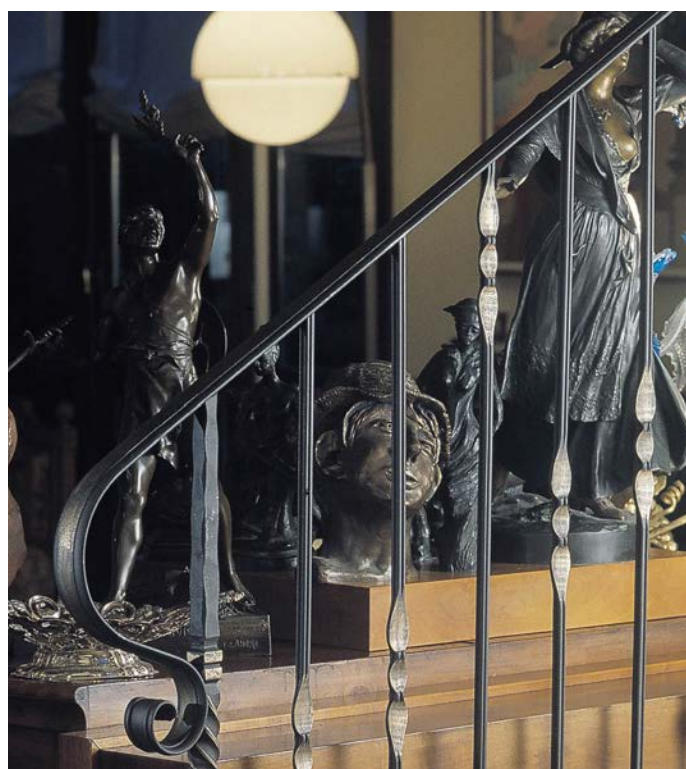

Pag.
 356

You can find our supports and accessories in section 17
 Nel capitolo 17 troverai reggicorrimani e accessori

Arteferro bars are produced by paying attention to detail and cut at the ends

Le barre Arteferro sono curate in ogni dettaglio ed anche rifilate alle estremità.

Hot hammered - Coniato a caldo

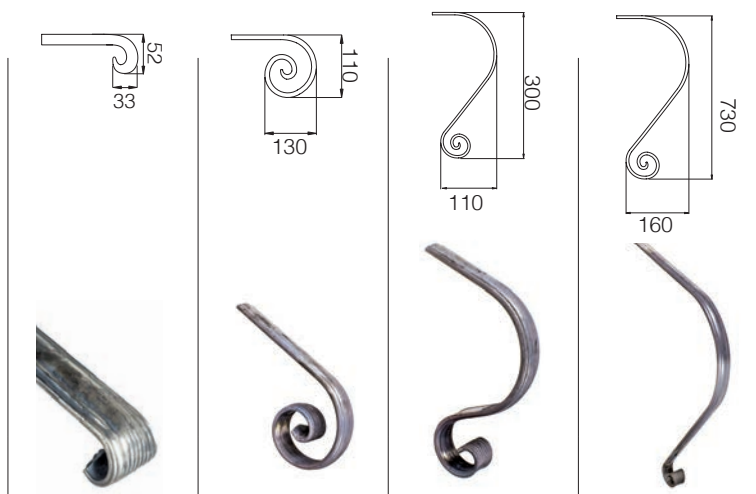

	L 3000 mm	L 6000 mm	Section Sezione				
	Art.	Art.		Art.	Art.	Art.	Art.
	158/9/C	158/9/C/6000	25 x 7 mm	-	-	-	-
	158/10/C	158/10/C/6000	30 x 8 mm	-	1819/29	1819/30	1819/13/S
	158/12/C	158/12/C/6000	40 x 8 mm	812/6/S	812/6	812/2	1819/14
	810/A/3	810/A/12	40 x 10 mm	-	812/7	812/3	1819/15
	810/7/C	810/7/C/6000	40 x 12 mm	-	1819/25	1819/21	1819/17
	810/A/5	810/A/14	50 x 10 mm	-	812/8	812/4	1819/16
	810/1	810/1/6000	20 x 10 mm	-	-	-	-
	810/2	810/2/6000	25 x 12,5 mm	-	-	-	-
	810/5	810/11	40 x 20 mm	-	812/5/S4	-	1819/17/S

The end piece of a handrail is a highly characterising element. Don't allow the processing and beauty of your handrail get spoiled by an unsightly welding between the end and the long bar. The extendable ends resolve this problem: starting with 3 meters rails, we can create the end you need.

La partenza di un corrimano è un elemento altamente caratterizzante. Non lasciare che la lavorazione e la bellezza del tuo corrimano venga interrotta da una antiestetica saldatura tra la partenza e la barra lunga. Le partenze allungate risolvono questo problema: partendo da una barra di 3 metri realizzeremo la partenza che ti serve.

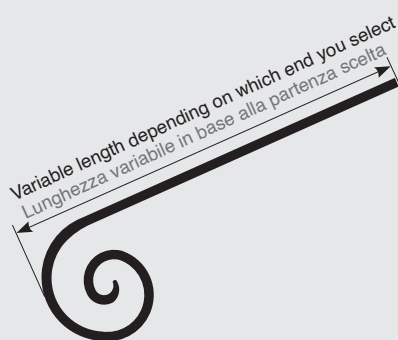

Add "/XL" at the end of the code for your end piece to order extra-long. You'll achieve an excellent result, without any visible welds.

Aggiungi "/XL" alla fine del codice della tua partenza per ordinare la versione extra lunga. Otterrai un risultato eccellente, senza saldature.

Example - Esempio

1817/9/XL

= Extended version

= Versione allungata



Variable length depending on which end you select
Lunghezza variabile in base alla partenza scelta

Add "/XL" at the end of the code for your end piece to order extra-long. You'll achieve an excellent result, without any visible welds.

Aggiungi "/XL" alla fine del codice della tua partenza per ordinare la versione extra lunga. Otterrai un risultato eccellente, senza saldature.

Tapered manually forged
Rastremato forgiato manualmente

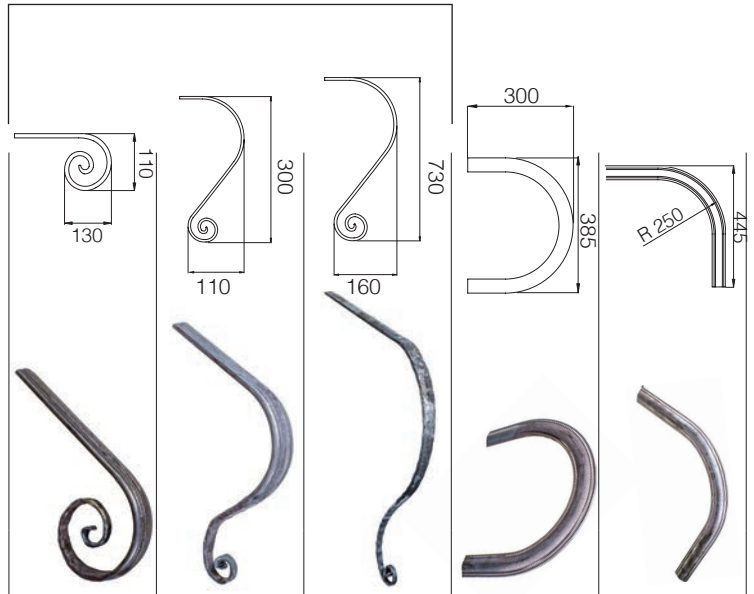

Example - Esempio

1820/11/XL = Extended version
= Versione allungata



L 2000 mm		Section - Sezione	Art.	Art.	Art.	Art.	Art.
Art.			114/1	115/4	115/5	1822/9	1822/20
		∅ 56 x 14 mm					



L 2000 mm	114/2	-	∅ 58 x 17 mm	115/3	115/2	114/B/3	1822/10	1822/21
-----------	-------	---	--------------	-------	-------	---------	---------	---------

END PIECES FOR COLD ROLLED HANDRAILS
PARTENZE PER CORRIMANI LAMINATO A FREDDO

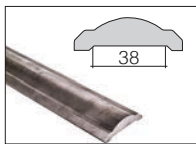

L 2500 mm	811/1	-	∅ 56 x 17 mm	812/9	812/10	812/11	1822/5	1822/16
-----------	-------	---	--------------	-------	--------	--------	--------	---------





Hot hammered - Coniato a caldo

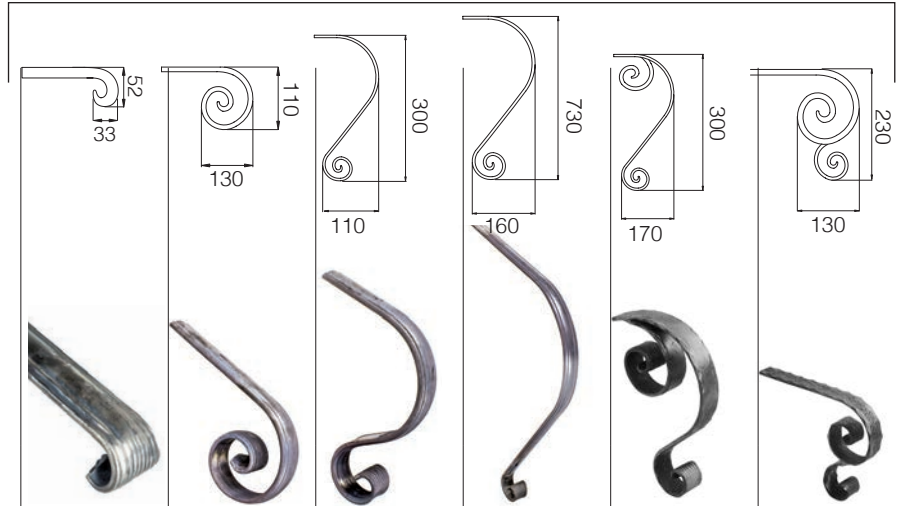

L 3000 mm		L 6000 mm		Section - Sezione							
Art.	Art.			Art.	Art.	Art.	Art.	Art.	Art.		
	811/5/T	811/8/T	∅ A50 x B14 x C25,4 mm	-	812/15/T	1377/42/T	1820/11	-	-		
	811/3/T	811/6/T	∅ A59 x B16,5 x C32,5 mm	812/12/T/S	812/12/T	1377/10/T	-	-	-		
	-	-	∅ A80 x B18,5 x C41 mm	-	1820/14	1820/13	1820/12	-	-		
	811/4/T	811/7/T	∅ A41 x B11 x C25,5 mm	-	812/13/T	1377/41/T	1820/10	-	-		
	810/B/13/T	810/B/16/T	∅ A40 x B8,5 x C20,7 mm	-	1377/20/T	1377/7/T	-	-	-		
	810/B/14/T	-	∅ A45 x B9 x C20,8 mm	-	1377/21/T	1377/8/T	-	-	-		
	810/B/15/T	810/B/18/T	∅ A50 x B9 x C25,7 mm	-	1377/22/T	1377/9/T	1820/7	-	-		

L 3000 mm L 6000 mm

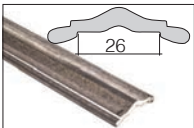
	810/B/19/T	810/B/20/T	∅ 43 x 11 mm	-	1377/18/T	1377/5/T	1820/8	-	-		
--	------------	------------	--------------	---	-----------	----------	--------	---	---	--	--

L 3000 mm L 6000 mm

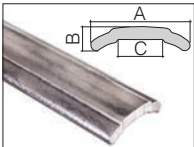
	810/B/1/T	810/B/5/T	∅ A35 x B9 x C15 mm	-	1377/14/T	1377/1/T	1820/1	-	-		
	810/B/2/T	810/B/6/T	∅ A41 x B9 x C21,1 mm	-	1377/15/T	1377/2/T	1820/2	-	-		
	810/B/3/T	810/B/7/T	∅ A45 x B14 x C20,8 mm	-	1377/16/T	1377/3/T	1820/3	-	-		
	810/B/4/T	810/B/8/T	∅ A50 x B14 x C20,7 mm	-	1377/17/T	1377/4/T	1820/4	-	-		

L 3000 mm L 6000 mm

	114/9	114/9/6000	∅ 30 x 8 mm	1818/11/S	1818/11	1818/7	1818/1	-	-		
	1838/2	1838/2/6000	∅ 40 x 8 mm	-	1818/12	1818/8	1818/2	1378/14/S	1378/5/S		
	1838/3	1838/3/6000	∅ 50 x 8 mm	-	1818/13	1818/9	1818/3	-	-		
	1838/4	1838/4/6000	∅ 60 x 8 mm	-	1818/14	1818/10	1818/4	-	-		

	114/10	114/10/6000	∅ 40 x 8 mm	-	116/14	116/6	114/B/9	1378/15	1378/6		
--	--------	-------------	-------------	---	--------	-------	---------	---------	--------	--	--

Wavy grooves - Rigature ondulate

	114/10/S	-	∅ 40 x 8 mm	-	116/14/S	116/6/S	-	-	-		
--	----------	---	-------------	---	----------	---------	---	---	---	--	--

Straight grooves - Rigature dritte

	114/5	114/5/6000	∅ 40 x 8 mm	116/10/S7	116/10	116/2	114/B/5	1378/11	1378/2		
	114/13	114/13/6000	∅ 50 x 8 mm	-	116/10/S1	116/2/S1	114/B/5/S	1378/11/S1	1378/2/S		
	-	114/14/6000	∅ 40 x 6 mm	-	116/10/S3	116/2/S2	114/B/5/S3	-	-		

	118/14	118/14/6000	∅ 40 x 8 mm	-	116/37	116/36	114/B/12	1378/18	1378/9		
	118/13	118/13/6000	∅ 30 x 8 mm	-	116/37/S1	116/36/S1	-	-	-		

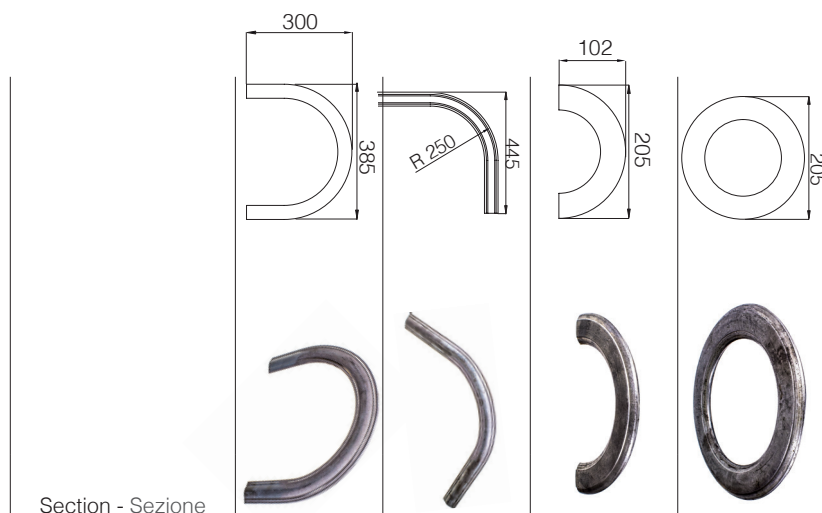

Variable length depending on which end you select
 Lunghezza variabile in base alla partenza scelta

Add "/ XL" at the end of the code for your end piece to order extra-long. You'll achieve an excellent result, without any visible welds.

Aggiungi "/XL" alla fine del codice della tua partenza per ordinare la versione extra lunga. Otterrai un risultato eccellente, senza saldature.

Example - Esempio

116/10/XL = Extended version
 = Versione allungata

Section - Sezione	Art.	Art.	Art.	Art.
☒ A50 x B14 x C25,4 mm	-	-	1825/28	1825/18
☒ A59 x B16,5 x C32,5 mm	-	-	-	1825/16
☒ A80 x B18,5 x C41 mm	-	-	1825/27	1825/17
☒ A41 x B11 x C25,5 mm	-	-	-	-

☒ A40 x B8,5 x C20,7 mm	-	-	1825/23	1825/13
☒ A45 x B9 x C20,8 mm	-	-	1825/24	1825/14
☒ A50 x B9 x C25,7 mm	-	-	1825/25	1825/15

☒ 43 x 11 mm	-	-	-	-
--------------	---	---	---	---

☒ A35 x B9 x C15 mm	-	-	1825/19	1825/9
☒ A41 x B9 x C21,1 mm	-	-	1825/20	1825/10
☒ A45 x B14 x C20,8 mm	-	-	1825/21	1825/11
☒ A50 x B14 x C20,7 mm	-	-	1825/22	1825/12

☒ 30 x 8 mm	1825/9	1825/5	-	-
☒ 40 x 8 mm	1825/2	1825/6	-	-
☒ 50 x 8 mm	-	1825/7	-	-
☒ 60 x 8 mm	1825/4	1825/8	-	-

☒ 40 x 8 mm	116/A/3	116/30	-	-
-------------	---------	--------	---	---

☒ 40 x 8 mm	-	-	-	-
-------------	---	---	---	---

☒ 40 x 8 mm	116/A/9	116/26	-	-
☒ 50 x 8 mm	-	-	-	-
☒ 40 x 6 mm	-	-	-	-

☒ 40 x 8 mm	116/A/16	116/39	-	-
☒ 30 x 8 mm	-	-	-	-

Hot hammered - Coniato a caldo

Variable length depending on which end you select
Lunghezza variabile in base alla partenza scelta

Add "/XL" at the end of the code for your end piece to order extra-long. You'll achieve an excellent result, without any visible welds.

Aggiungi "/XL" alla fine del codice della tua partenza per ordinare la versione extra lunga. Otterrai un risultato eccellente, senza saldature.

Example - Esempio

116/11/XL = Extended version
= Versione allungata

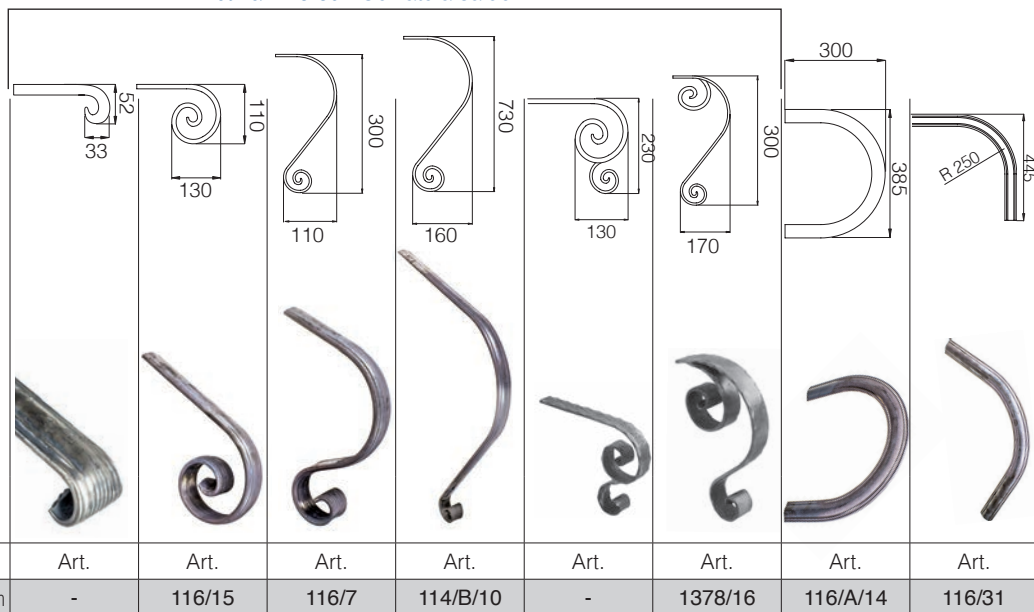

	L 3000 mm	L 6000 mm	Sezione	Art.	Art.	Art.	Art.	Art.	Art.	Art.	Art.	Art.
	Art. 114/11	Art. 114/11/6000	40 x 8 mm	-	116/15	116/7	114/B/10	-	1378/16	116/A/14	116/31	
	Art. 114/12	Art. 114/12/6000	40 x 8 mm	-	116/16	116/8	114/B/11	1378/8	1378/17	116/A/15	116/32	
	Art. 114/8	Art. 114/8/6000	40 x 8 mm	-	116/13	116/5	114/B/8	1378/5	1378/14	116/A/12	116/29	
	Art. 114/6	Art. 114/6/6000	40 x 8 mm	-	116/11	116/3	114/B/6	1378/3	1378/12	-	116/27	
	Art. 114/7	Art. 114/7/6000	40 x 8 mm	-	116/12	116/4	-	-	1378/13	116/A/11	116/28	
	Art. 114/4	Art. 114/4/6000	40 x 8 mm	-	116/9	116/1	114/B/4	1378/1	1378/10	116/A/8	116/25	

Slotted steel for plastic, moldable handrail
Ferro dentellato per corrimano in plastica modellabile
Art. 118/F/9



Art. 118/F/10
40 x 8 mm
L 1500 mm

Moldable plastic handrail Rolls of 25 metres
Plastica modellabile Rotoli da 25 mt



altri colori disponibili / another colors available

- gold / oro
- blue / blu
- white / bianco







Art. 118/F/9
black - nero
for/per 40 x 8 mm

Tubular steel handrail 1.5 mm thick.
Corrimano tubolare in ferro spessore 1,5 mm







Art. 118/F/8/3000
50 x 25 mm
L 3000 mm
Art. 118/F/8
50 x 25 mm
L 6000 mm

Worked on one side - Lavorato su un lato

Section Sezione							
	L 4000 mm	L 3000 mm	L 3000 mm	L 3000 mm	L 3000 mm	L 3000 mm	L 3000 mm
	Art.	Art.	Art.	Art.	Art.	Art.	Art.
∅ 16 x 3 mm	1839/25	-	-	-	-	-	-
∅ 30 x 5 mm	-	1838/8	-	-	-	-	-
∅ 31 x 5 mm	-	-	1834/2	1834/3	-	-	1834/4
∅ 32 x 5 mm	-	-	-	-	1834/1	-	-
∅ 32 x 6 mm	-	-	-	-	-	1834/9	-
	L 6000 mm	L 6000 mm	L 6000 mm	L 6000 mm	L 6000 mm	L 6000 mm	L 6000 mm
∅ 30 x 5 mm	-	1838/8/6000	-	-	-	-	-
∅ 31 x 5 mm	-	-	1834/2/6000	1834/3/6000	-	-	1834/4/6000
∅ 32 x 5 mm	-	-	-	-	1834/1/6000	-	-
∅ 32 x 6 mm	-	-	-	-	-	1834/9/6000	-

Section Sezione						
	L 3000 mm	L 3000 mm	L 3000 mm	L 3000 mm	L 3000 mm	L 3000 mm
	Art.	Art.	Art.	Art.	Art.	Art.
∅ 17 x 5 mm	-	-	-	-	-	114/A/6
∅ 30 x 5 mm	-	-	-	-	114/A/5	-
∅ 31 x 5 mm	-	-	-	-	-	-
∅ 32 x 6 mm	-	-	1834/7	-	-	-
∅ 32 x 7 mm	1834/5	-	-	-	-	-
∅ 32 x 9 mm	-	-	-	1834/8	-	-

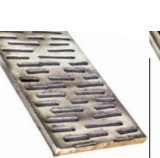
	L 6000 mm	L 6000 mm	L 6000 mm	L 6000 mm	L 6000 mm	L 6000 mm
∅ 17 x 5 mm	-	-	-	-	-	-
∅ 30 x 5 mm	-	-	-	-	114/A/5/6000	-
∅ 31 x 5 mm	-	1834/6/6000	-	-	-	-
∅ 32 x 6 mm	-	-	-	-	-	-
∅ 32 x 7 mm	1834/5/6000	-	1834/7/6000	-	-	-
∅ 32 x 9 mm	-	-	-	1834/8/6000	-	-

Section Sezione				
	L 3000 mm	L 3000 mm	L 2000 mm	L 2000 mm
	Art.	Art.	Art.	Art.
∅ 23 x 4 mm	1837/1	-	-	-
∅ 27 x 5 mm	1837/2	-	-	-
∅ 30 x 6 mm	-	1837/6	-	-
∅ 37 x 7 mm	1837/3	-	-	-
∅ 41 x 8 mm	-	-	-	-
∅ 100 x 8 mm	-	-	1370/1	1370/3
∅ 120 x 8 mm	-	-	1370/2	1370/4

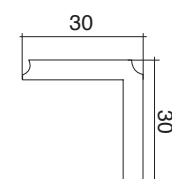

Angular profile
Profilo angolare



Only hammered
on one side / 2 angles
Lavorato solo
su un lato/ 2 angoli

Art. 1373/1
30 x 30 x 4 mm
L 3000 mm

Art. 1373/1/6000
30 x 30 x 4 mm
L 6000 mm

	L 6000 mm	L 6000 mm	L 6000 mm	L 6000 mm
∅ 20 x 4 mm	1837/1/6000	-	-	-
∅ 23 x 4 mm	1837/2/6000	-	-	-
∅ 27 x 5 mm	-	1837/6/6000	-	-
∅ 100 x 8 mm	-	-	1370/1/6000	1370/3/6000
∅ 120 x 8 mm	-	-	1370/2/6000	1370/4/6000

1 groove on each side
1 solco per lato



Section Sezione	Twisted to the left Attorcigliatura sinistra		Twisted to the right Attorcigliatura destra		Twisted to the left Attorcigliatura sinistra		Twisted to the right Attorcigliatura destra		Twisted to the left Attorcigliatura sinistra		Twisted to the right Attorcigliatura destra	
	L 3000 mm	L 6000 mm	L 3000 mm	L 6000 mm	L 3000 mm	L 6000 mm	L 3000 mm	L 6000 mm	L 3000 mm	L 6000 mm	L 3000 mm	L 6000 mm
	Art.	Art.	Art.	Art.	Art.	Art.	Art.	Art.	Art.	Art.	Art.	Art.
□ 8 x 8 mm	118/H/18	118/H/7	-	-	-	-	-	-	-	-	-	-
□ 10 x 10 mm	118/H/19	118/H/8	-	-	-	-	-	-	-	-	-	-
□ 12 x 12 mm	118/H/20	118/H/9	-	-	-	-	-	-	-	-	-	-
□ 14 x 14 mm	118/H/21	118/H/10	-	-	-	-	-	-	-	-	-	-
□ 16 x 16 mm	118/H/22	118/H/11	-	-	-	-	-	-	-	-	-	-
□ 18 x 18 mm	-	118/H/12	-	-	-	-	-	-	-	-	-	-
□ 20 x 20 mm	118/H/24	118/H/13	-	-	-	-	-	-	-	-	-	-
□ 22 x 22 mm	-	-	-	-	-	-	-	-	-	-	-	-
□ 24 x 24 mm	-	-	-	-	-	-	-	-	-	-	-	-
□ 25 x 25 mm	118/H/25	118/H/14	-	-	-	-	-	-	-	-	-	-
□ 26 x 26 mm	-	-	-	-	-	-	-	-	-	-	-	-
□ 28 x 28 mm	-	-	-	-	-	-	-	-	-	-	-	-
□ 30 x 30 mm	118/H/26	118/H/15	-	1806/22	-	-	-	-	1807/3	1807/6	1807/9	1807/12
□ 40 x 40 mm	1806/14	1806/16	1806/18	1806/21	-	-	-	-	1807/2	1807/5	1807/8	1807/11
□ 50 x 50 mm	1806/13	1806/15	1806/17	1806/20	-	-	-	-	1807/1	1807/4	1807/7	1807/10
▧ 20 x 6 mm	-	-	-	-	118/H/16	118/H/5	-	-	-	-	-	-
▧ 60 x 30 mm	-	-	-	-	1806/23	1806/25	1806/27	1806/29	-	-	-	-

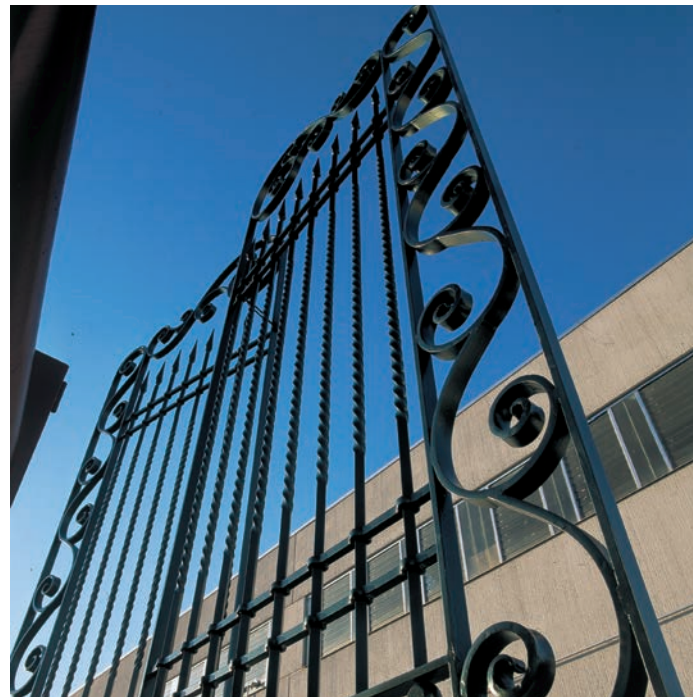

3 grooves on each side
3 solchi per lato

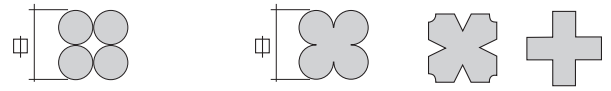

Section Sezione	Twisted to the left Attorcigliatura sinistra		Twisted to the right Attorcigliatura destra		L 2000 mm	L 2700 mm	L 5400 mm	L 5700 mm	L 3000 mm	L 2000 mm	L 2900 mm
	L 3000 mm	L 6000 mm	L 3000 mm	L 6000 mm							
	Art.	Art.	Art.	Art.	Art.	Art.	Art.	Art.	Art.	Art.	Art.
∅ 8 x 8 mm	-	-	-	-	-	-	-	-	-	-	-
∅ 10 x 10 mm	-	-	-	-	-	-	-	-	-	-	-
∅ 12 x 12 mm	-	-	-	-	118/F/1	119/1	119/1/5400	119/1/5700	626/3	-	-
∅ 14 x 14 mm	-	-	-	-	-	-	-	-	626/4	117/10	-
∅ 16 x 16 mm	-	-	-	-	118/F/2	119/2	119/2/5400	119/2/5700	626/5	117/11	-
∅ 18 x 18 mm	-	-	-	-	-	-	-	-	626/6	117/12	-
∅ 20 x 20 mm	-	-	-	-	118/F/3	-	-	-	626/7	117/13	-
∅ 22 x 22 mm	-	-	-	-	-	-	-	-	626/8	-	-
∅ 24 x 24 mm	-	-	-	-	118/F/4	119/3	119/3/5400	119/3/5700	-	-	-
∅ 25 x 25 mm	-	-	-	-	-	-	-	-	-	-	-
∅ 26 x 26 mm	-	-	-	-	-	-	-	-	626/9	-	-
∅ 28 x 28 mm	-	-	-	-	118/F/5	-	-	-	-	-	-
∅ 30 x 30 mm	1807/15	1807/18	1807/21	1807/24	-	-	-	-	-	117/14	-
∅ 40 x 40 mm	1807/14	1807/17	1807/20	1807/23	-	-	-	-	-	-	626/1
∅ 50 x 50 mm	1807/13	1807/16	1807/19	1807/22	-	-	-	-	-	-	626/2

* Hot grooved rope on 4 sides and beveled on 4 angles
Funne solcata a caldo 4 lati e smussata 4 angoli

* * Twisted cross iron
Ferro croce attorcigliato



Grooved tube
Tubo rigato



Twisted tube
Tubo attorcigliato



Section Sezione	L 3000 mm		L 2000 mm
	L 6000 mm	L 6000 mm	L 2000 mm
	Art.	Art.	Art.
∅ 30 mm x 2 mm thickn./spess.	1794/10	1794/10/6000	-
∅ 40 mm x 1,5 mm thickn./spess.	1794/9	1794/9/6000	-
∅ 20 x 20 mm x 2 mm thickn./spess.	-	-	118/F/6

HOT ROLLED PROFILES - PROFILI LAMINATI A CALDO

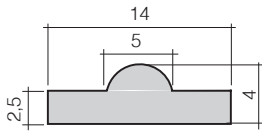

Art. 158/3
∅ 14 x 4 mm
L 4000 mm

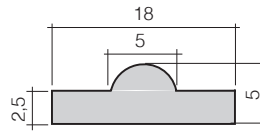

Art. 158/4
∅ 18 x 5 mm
L 4000 mm



Section - Sezione	L 3000 mm	L 4000 mm	L 6000 mm
	Art.	Art.	Art.
∅ 14 x 4 mm	-	158/1	-
∅ 18 x 5 mm	-	158/2	-
∅ 25 x 8 mm	158/49	-	158/52
∅ 30 x 8 mm	158/50	-	158/53
∅ 40 x 8 mm	158/51	-	158/54

On request we can produce pre-bended and cut to measure collars

Su richiesta possiamo produrre fascette pre-piegate e tagliate su misura

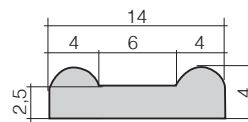

Section - Sezione AxB	L 4000 mm
	Art.
∅ 11 x 3 mm	158/5
∅ 14 x 4 mm	158/6
∅ 16 x 5 mm	158/7
∅ 21 x 6 mm	158/8

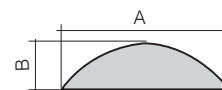

Art. 158/5
∅ 11 x 3 mm
L 4000 mm





Pierced bars Shaped bars *Barre forate* *Barre sagomate*

Arteferro pierced and shaped bars are items with of a wrought iron symbol. Beyond a protective function, they confer a touch of elegance that embellishes the buildings into which they are installed. Arteferro pierced bars are available in lengths up to 3 metres, with diverse machining and drilling. The opening can have either a circular, oval, square or rectangular section which can be made on the side or on the corner, in order to satisfy any aesthetic requirement.

Le barre forate e barre sagomate Arteferro sono degli elementi simbolo del ferro battuto. Al di là della funzione protettiva, conferiscono un tocco di eleganza che impreziosisce l'edificio in cui sono installate. Le barre forate Arteferro sono disponibili con lunghezze fino a 3 metri, con diverse lavorazioni e forature. L'apertura può avere sezione circolare, ovale, quadrata o rettangolare e può essere effettuata sia sul lato sia sullo spigolo, in modo da soddisfare ogni esigenza estetica.

arteferro



Pierced bars Shaped bars - Barre forate Barre sagomate

- A Round pierced bars Barre forate in tondo pag.46
- B Square pierced bars Barre forate in quadro pag.48
- C Flat punched bars Piatti forati pag.50
- D Pierced tubes Tubi forati pag.55
- E Pierced posts Montanti forati pag.56
- F Bars with stamped rivets Barre con ribattini stampati pag.58
- G Shaped bars Barre sagomate pag.60

Select the section first, then the type of hole and technical details (section, hole size, pitch, distance, no. of holes) At this point, identifying the finish will be easy.

Scegli prima la sezione e poi il tipo di foro e i dettagli tecnici (sezione, dimensione foro, interasse, luce, n. fori) A questo punto, individuare la finitura sarà un gioco da ragazzi.

Choose the pierced bar, add "/SAB" at the end of the code to order the sandblasted version or add "/Z" to order the galvanized version

Scegli la barra forata, aggiungi "/SAB" alla fine del codice per ordinare la versione sabbata o aggiungi "/Z" per ordinare la versione zincata a freddo

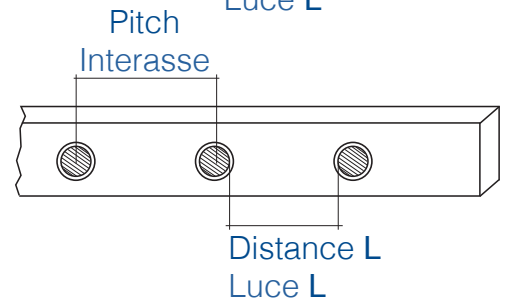
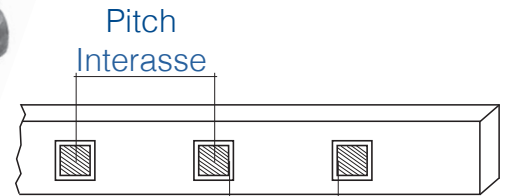

Example - Esempio

1360/6/SAB = sandblasted version = versione sabbata

1360/6/Z = galvanized version = versione zincata a freddo

L 2.000 mm

Section Sezione	Hole Foro	Section Ø Ø Sezione	Hole for Foro per	Pitch Interasse	Distance Luce	N. Holes N. Fori	Plain Liscio	Bark effect Corteccia
							Art.	Art.
Round hole Foro tondo		12 mm	12 mm	120 mm	108 mm	16	1360/6	-
		14 mm	14 mm	140 mm	126 mm	14	42/1 BEST PRICE	606/1
		14 mm	14 mm	124 mm	110 mm	14	42/A/1	-
		16 mm	16 mm	150 mm	134 mm	13	42/2	606/2
		16 mm	16 mm	126 mm	110 mm	14	42/A/2	-
		18 mm	18 mm	160 mm	142 mm	12	42/3	606/3
		18 mm	18 mm	128 mm	110 mm	14	42/A/3	-
		20 mm	20 mm	170 mm	150 mm	11	42/4	606/4
		20 mm	20 mm	130 mm	110 mm	14	42/A/4	-
		20 mm	20 mm	85 mm		22	6020/3	
		22 mm	22 mm	170 mm	148 mm	11	42/5	-
		25 mm	25 mm	180 mm	155 mm	10	42/6	-
30 mm	30 mm	200 mm	170 mm	9	42/7			
Oval hole Foro ovale		14 mm	28 x 14 mm	140 mm	126 mm	14	607/1	-
		16 mm	32 x 16 mm	150 mm	134 mm	13	607/2	-
		18 mm	34 x 18 mm	160 mm	142 mm	12	607/3	-
		20 mm	38 x 20 mm	170 mm	150 mm	11	607/4	-

L 2.000 mm



Square hole on the side - Foro quadro su lato

Square hole on the side - Foro quadro su lato

Square hole on the edge - Foro quadro su spigolo

Section Sezione	Hole Foro	Section Φ Sezione Φ	Hole for Foro per	Pitch Interasse	Distance Luce	N. Holes N. Fori	Plain Liscio	Bark effect Corteccia	Four-leaf clover Quadrifoglio	Hammered Spigolato	Power hammered Magliato
							Art.	Art.	Art.	Art.	Art.
□	□	12 mm	12 x 12 mm	120 mm	108 mm	16	1360/7	-	-	1360/1	-
		12 mm	12 x 12 mm	140 mm		14	-	-	1361/5	-	-
		12 mm	12 x 12 mm	223 mm		8	6139/1	-	-	-	-
		14 mm	14 x 14 mm	140 mm	126 mm	14	42/8	605/1	-	1360/2	-
		14 mm	14 x 14 mm	124 mm	110 mm	14	42/A/5	-	-	-	-
		14 mm	14 x 14 mm	140 mm	-	14	-	-	-	-	6096/2
		15 mm	15 x 15 mm	160 mm	-	12	-	-	-	-	-
		16 mm	16 x 16 mm	150 mm	-	13	42/9	605/2	-	1360/3	6048/4
		16 mm	16 x 16 mm	126 mm	110 mm	14	42/A/6	-	-	-	-
		17 mm	17 x 17 mm	160 mm	-	11	-	-	1361/8	-	-
		18 mm	18 x 18 mm	160 mm	142 mm	12	42/10	605/3	-	-	-
		18 mm	18 x 18 mm	128 mm	110 mm	14	42/A/7	-	-	-	-
		18 mm	12 x 12 mm	122 mm	110 mm	14	42/A/17	-	-	-	-
		18 mm	14 x 14 mm	124 mm	110 mm	14	42/A/18	-	-	-	-
		20 mm	20 x 20 mm	170 mm	150 mm	11	42/11	605/4	-	-	-
		20 mm	20 x 20 mm	130 mm	110 mm	14	42/A/8	-	-	-	-
		22 mm	22 x 22 mm	170 mm	148 mm	11	42/12	-	-	-	-
25 mm	25 x 25 mm	180 mm	165 mm	10	42/13	-	-	-	-		
30 mm	30 x 30 mm	200 mm	190 mm	9	42/14	-	-	-	607/4	-	
□	◊	12 mm	12 x 12 mm	140 mm	-	14	-	-	1361/1	-	-
		14 mm	14 x 14 mm	140 mm	-	14	42/22	605/5	-	-	-
		14 mm	14 x 14 mm	129,8 mm	110 mm	14	42/A/13	-	-	-	-
		14 mm	14 x 14 mm	150 mm	-	13	-	-	1361/2	-	-
		15 mm	15 x 15 mm	160 mm	-	12	-	-	1361/3	-	-
		16 mm	16 x 16 mm	150 mm	-	13	42/23	605/6	-	-	-
		16 mm	16 x 16 mm	132,6 mm	110 mm	14	42/A/14	-	-	-	-
		17 mm	17 x 17 mm	170 mm	-	11	-	-	1361/4	-	-
		18 mm	18 x 18 mm	160 mm	-	12	42/24	605/7	-	-	-
		18 mm	18 x 18 mm	135,5 mm	110 mm	14	42/A/15	-	-	-	-
		18 mm	18 x 18 mm	125 mm	-	15	42/A/15/S	-	-	-	-
		20 mm	20 x 20 mm	170 mm	-	11	42/25	605/8	-	-	-
		20 mm	20 x 20 mm	138,3 mm	110 mm	14	42/A/16	-	-	-	-
		20 mm	16 x 16 mm	125 mm	-	14	42/A/16/SP3	-	-	-	-
22 mm	22 x 22 mm	170 mm	-	11	42/26	-	-	-	-		
25 mm	25 x 25 mm	180 mm	-	10	42/27	-	-	-	-		
30 mm	30 x 30 mm	200 mm	-	9	42/28	-	-	-	-		
◊	◊	14 mm	14 x 14 mm	140 mm	-	14	42/15	-	-	-	-
		14 mm	14 x 14 mm	129,8 mm	110 mm	14	42/A/9	-	-	-	-
		16 mm	16 x 16 mm	150 mm	-	13	42/16	-	-	-	-
		16 mm	16 x 16 mm	132,6 mm	110 mm	14	42/A/10	-	-	-	-
		18 mm	18 x 18 mm	160 mm	-	12	42/17	-	-	-	-
		18 mm	18 x 18 mm	135,5 mm	110 mm	14	42/A/11	-	-	-	-
		20 mm	20 x 20 mm	170 mm	-	11	42/18	-	-	-	-
		20 mm	20 x 20 mm	138,3 mm	110 mm	14	42/A/12	-	-	-	-
		22 mm	22 x 22 mm	170 mm	-	11	42/19	-	-	-	-
		25 mm	25 x 25 mm	180 mm	-	10	42/20	-	-	-	-
30 mm	30 x 30 mm	200 mm	-	9	42/21	-	-	-	-		

L 2.000 mm

Oval hole on edge
Foro ovale su spigolo

square bar with rectangular hole
barra quadrata con foro rett.

square bar with round hole
barra quadrata con foro tondo

Section Sezione	Hole Foro	Section \varnothing Sezione \varnothing	Hole for Foro per	Pitch Interasse	Distance Luce	N. Holes N. Fori	Plain Liscio Art.
		14 mm	18 x 15 mm	158 mm	140 mm	14	1845/16
		16 mm	32 x 17 mm	182 mm	150 mm	13	1845/17
		18 mm	34 x 19 mm	194 mm	160 mm	12	1845/18
		20 mm	38 x 21 mm	208 mm	170 mm	11	1845/19
		14 mm	24 x 15 mm	164 mm	140 mm	14	1845/20
		16 mm	30 x 17 mm	180 mm	150 mm	13	1845/21
		18 mm	31 x 19 mm	191 mm	160 mm	12	-
		20 mm	33 x 21 mm	203 mm	170 mm	11	1845/23
		14 mm	15 mm	155 mm	140 mm	14	1845/24
		16 mm	17 mm	167 mm	150 mm	13	1845/25
		18 mm	19 mm	179 mm	160 mm	12	1845/26
		20 mm	21 mm	191 mm	170 mm	11	1845/27



HOT PIERCED - FORATI A CALDO

L 2.000 mm approx. - circa

Section Sezione	Hole Foro	Hole for Foro per	Pitch Interasse	Distance Luce	Hole N. N. Fori	Plain Liscio Art.
30 x 15 mm		18 x 18 mm	140 mm	122 mm	13	1360/10
30 x 20 mm		18 x 18 mm	140 mm	122 mm	13	1360/11



L 2.000 mm approx. - circa

Section Sezione	Hole Foro	Hole for Foro per	Pitch Interasse	Distance Luce	Hole N. N. Fori	Plain Liscio Art.
30 x 15 mm		20 mm	140 mm	120 mm	14	1360/8
30 x 20 mm		20 mm	140 mm	120 mm	14	1360/9





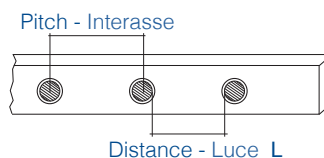

L 2.000 mm approx. - circa

Section Sezione	Hole Foro	Hole for Foro per	Pitch Interasse	Distance Luce	Hole N. N. Fori	Plain Liscio		
						Art.		
30 x 8 mm		12 mm	112 mm	100 mm	17	1853/105		
			125 mm	113 mm	15	1853/105/S1		
			127 mm	115 mm	15	1853/106		
			142 mm	130 mm	13	1853/107		
		14 mm	114 mm	100 mm	16	1853/108		
			125 mm	111 mm	15	1853/108/S1		
			129 mm	115 mm	14	1853/109		
			144 mm	130 mm	13	1853/110		
		16 mm	116 mm	100 mm	16	1853/111		
			131 mm	115 mm	14	1853/112		
			146 mm	130 mm	13	1853/113		
30 x 10 mm		12 mm	112 mm	100 mm	17	1853/114		
			127 mm	115 mm	15	1853/115		
			142 mm	130 mm	13	1853/116		
		14 mm	114 mm	100 mm	16	1853/117		
			129 mm	115 mm	14	1853/118		
			144 mm	130 mm	13	1853/119		
		16 mm	116 mm	100 mm	16	1853/120		
			131 mm	115 mm	14	1853/121		
			146 mm	130 mm	13	1853/122		
		35 x 8 mm		12 mm	112 mm	100 mm	17	1853/123
					127 mm	115 mm	15	1853/124
142 mm	130 mm				13	1853/125		
14 mm	114 mm			100 mm	16	1853/126		
	129 mm			115 mm	14	1853/127		
	144 mm			130 mm	13	1853/128		
16 mm	116 mm			100 mm	16	1853/129		
	131 mm			115 mm	14	1853/130		
	146 mm			130 mm	13	1853/131		
35 x 10 mm				12 mm	112 mm	100 mm	17	1853/132
					127 mm	115 mm	15	1853/133
		142 mm	130 mm		13	1853/134		
		14 mm	114 mm	100 mm	16	1853/135		
			129 mm	115 mm	14	1853/136		
			144 mm	130 mm	13	1853/137		
		16 mm	116 mm	100 mm	16	1853/138		
			131 mm	115 mm	14	1853/139		
			146 mm	130 mm	13	1853/140		
		40 x 8 mm		12 mm	112 mm	100 mm	17	1853/141
					125 mm	113 mm	15	1853/142/S
127 mm	115 mm				15	1853/142		
142 mm	130 mm				13	1853/143		
14 mm	114 mm			100 mm	16	1853/144		
	125 mm			111 mm	15	1853/144/S1		
	129 mm			115 mm	14	1853/145		
	144 mm			130 mm	13	1853/146		
16 mm	116 mm			100 mm	16	1853/147		
	131 mm			115 mm	14	1853/148		
	146 mm			130 mm	13	1853/149		
40 x 10 mm		12 mm	112 mm	100 mm	17	1853/150		
			127 mm	115 mm	15	1853/151		
			142 mm	130 mm	13	1853/152		
		14 mm	114 mm	100 mm	16	1853/153		
			129 mm	115 mm	14	1853/154		
			144 mm	130 mm	13	1853/155		
		16 mm	116 mm	100 mm	16	1853/156		
			131 mm	115 mm	14	1853/157		
			146 mm	130 mm	13	1853/158		

Choose the pierced bar, add "/SAB" at the end of the code to order the sandblasted version or add "/Z" to order the galvanized version

Scegli la barra forata, aggiungi "/SAB" alla fine del codice per ordinare la versione sabbiata o aggiungi "/Z" per ordinare la versione zincata a freddo

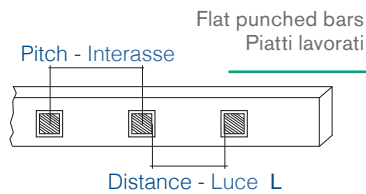

L 2.000 mm approx. - circa

Section Sezione	Hole Foro	Hole for Foro per	Pitch Interasse	Distance Luce	Hole N. N. Fori	Plain Liscio
						Art.
30 x 8 mm		12 x 12 mm	112 mm	100 mm	17	1853/1
			125 mm	113 mm	15	1853/1/S1
			127 mm	115 mm	15	1853/2
		14 x 14 mm	142 mm	130 mm	13	1853/3
			114 mm	100 mm	16	608/6
			125 mm	111 mm	15	1853/4/S
			129 mm	115 mm	14	1853/4
		16 x 16 mm	144 mm	130 mm	13	608/5
			116 mm	100 mm	16	1853/5
			131 mm	115 mm	14	1853/6
30 x 10 mm		12 x 12 mm	146 mm	130 mm	13	1853/7
			112 mm	100 mm	17	1853/8
			127 mm	115 mm	15	1853/9
		14 x 14 mm	142 mm	130 mm	13	1853/10
			114 mm	100 mm	16	1853/11
			129 mm	115 mm	14	1853/12
			144 mm	130 mm	13	1853/13
16 x 16 mm	116 mm	100 mm	16	1853/14		
	131 mm	115 mm	14	1853/15		
35 x 8 mm		12 x 12 mm	146 mm	130 mm	13	1853/16
			112 mm	100 mm	17	1853/17
			127 mm	115 mm	15	1853/18
		14 x 14 mm	142 mm	130 mm	13	1853/19
			114 mm	100 mm	16	1853/20
			129 mm	115 mm	14	1853/21
			144 mm	130 mm	13	1853/22
16 x 16 mm	116 mm	100 mm	16	1853/23		
	131 mm	115 mm	14	1853/24		
	146 mm	130 mm	13	1853/25		
35 x 10 mm		12 x 12 mm	112 mm	100 mm	17	1853/26
			127 mm	115 mm	15	1853/27
			142 mm	130 mm	13	1853/28
		14 x 14 mm	114 mm	100 mm	16	1853/29
			129 mm	115 mm	14	1853/30
			144 mm	130 mm	13	1853/31
			116 mm	100 mm	16	1853/32
		16 x 16 mm	131 mm	115 mm	14	1853/33
			146 mm	130 mm	13	1853/34
			40 x 8 mm		12 x 12 mm	112 mm
125 mm	113 mm	15				1853/37/S
127 mm	115 mm	15				1853/36
14 x 14 mm	142 mm	130 mm			13	1853/37
	114 mm	100 mm			16	608/8
	125 mm	111 mm			15	1853/38/S
	129 mm	115 mm			14	1853/38
16 x 16 mm	144 mm	130 mm	13	608/7		
	116 mm	100 mm	16	1853/39		
	131 mm	115 mm	14	1853/40		
	146 mm	130 mm	13	1853/41		
40 x 10 mm		12 x 12 mm	112 mm	100 mm	17	1853/42
			127 mm	115 mm	15	1853/43
			142 mm	130 mm	13	-
		14 x 14 mm	114 mm	100 mm	16	1853/45
			129 mm	115 mm	14	1853/46
			144 mm	130 mm	13	1853/47
		16 x 16 mm	116 mm	100 mm	16	1853/48
			131 mm	115 mm	14	1853/49
			146 mm	130 mm	13	1853/50



The punched plates can also be made to measure up to 6 metres.

I piatti forati sono realizzabili anche su misura fino a 6 mt.

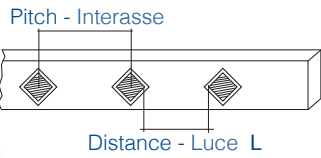

The punched plates can also be made to measure up to 6 metres.

I piatti forati sono realizzabili anche su misura fino a 6 mt.

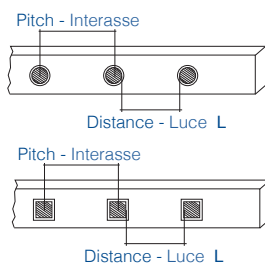
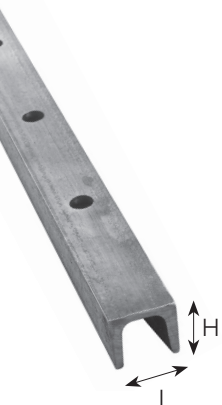

L 2.000 mm approx. - circa

Section Sezione	Hole Foro	Hole for Foro per	Pitch Interasse	Distance Luce	Hole N. N. Fori	Plain Liscio	
						Art.	
30 x 8 mm	◇	12 x 12 mm	117 mm	100 mm	16	1853/51	
			125 mm	108 mm	15	1853/51/S	
			132 mm	115 mm	14	1853/52	
		14 x 14 mm	147 mm	130 mm	13	1853/53	
			119,8 mm	100 mm	16	1853/54	
			125 mm	105,2 mm	15	1853/55/S	
	16 x 16 mm	134,8 mm	115 mm	14	1853/55		
		149,8 mm	130 mm	12	1853/56		
		122,6 mm	100 mm	15	1853/57		
	30 x 10 mm	◇	12 x 12 mm	117 mm	100 mm	16	1853/60
				132 mm	115 mm	14	1853/61
				147 mm	130 mm	13	1853/62
14 x 14 mm			119,8 mm	100 mm	16	1853/63	
			134,8 mm	115 mm	14	1853/64	
			149,8 mm	130 mm	12	1853/65	
16 x 16 mm		122,6 mm	100 mm	15	1853/66		
		137,6 mm	115 mm	13	1853/67		
		152,6 mm	130 mm	12	1853/68		
35 x 8 mm		◇	12 x 12 mm	117 mm	100 mm	16	1853/69
				132 mm	115 mm	14	1853/70
				147 mm	130 mm	13	1853/71
	14 x 14 mm		119,8 mm	100 mm	16	1853/72	
			134,8 mm	115 mm	14	1853/73	
			149,8 mm	130 mm	12	-	
	16 x 16 mm	122,6 mm	100 mm	15	1853/75		
		137,6 mm	115 mm	13	1853/76		
		152,6 mm	130 mm	12	1853/77		
	35 x 10 mm	◇	12 x 12 mm	117 mm	100 mm	16	1853/78
				132 mm	115 mm	14	1853/79
				147 mm	130 mm	13	1853/80
14 x 14 mm			119,8 mm	100 mm	16	1853/81	
			134,8 mm	115 mm	14	1853/82	
			149,8 mm	130 mm	12	1853/83	
16 x 16 mm		122,6 mm	100 mm	15	1853/84		
		137,6 mm	115 mm	13	1853/85		
		152,6 mm	130 mm	12	1853/86		
40 x 8 mm		◇	12 x 12 mm	117 mm	100 mm	16	1853/87
				125 mm	108 mm	15	1853/88/S1
				132 mm	115 mm	14	1853/88
	14 x 14 mm		147 mm	130 mm	13	1853/89	
			119,8 mm	100 mm	16	1853/90	
			125 mm	105,2 mm	15	1853/91/S	
	16 x 16 mm	134,8 mm	115 mm	14	1853/91		
		149,8 mm	130 mm	12	1853/92		
		122,6 mm	100 mm	15	1853/93		
	40 x 10 mm	◇	12 x 12 mm	117 mm	100 mm	16	1853/96
				132 mm	115 mm	14	1853/97
				147 mm	130 mm	13	1853/98
14 x 14 mm			119,8 mm	100 mm	16	1853/99	
			134,8 mm	115 mm	14	1853/100	
			149,8 mm	130 mm	12	1853/101	
16 x 16 mm		122,6 mm	100 mm	15	1853/102		
		137,6 mm	115 mm	13	1853/103		
		152,6 mm	130 mm	12	1853/104		

L 2.000 mm approx. - circa

H x L	Hole Foro	Hole for Foro per	Pitch Interasse	Distance Luce	Hole N. N. Fori	Plain Liscio
						Art.
35 x 40 mm	○	Ø 14 mm	144 mm	130 mm	13	608/2
35 x 40 mm	□	14 x 14 mm	144 mm	130 mm	15	608/3

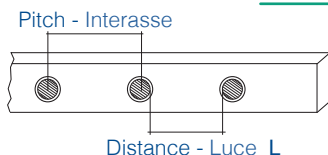
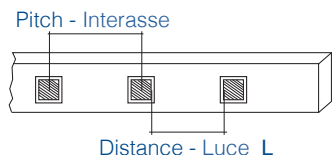

L 2.000 mm approx. - circa

Section Sezione	Hole Foro	Hole for Foro per	Pitch Interasse	Distance Luce	Hole N. N. Fori	Hammered on 2 corners Spigolato su 2 angoli	Hammered on 4 edges and 2 sides Battuto 4 spigoli e 2 lati	
						Art.	Art.	
30 x 8 mm		12 x 12 mm	112 mm	100 mm	17	1853/159	1853/195	
			127 mm	115 mm	15	1853/160	1853/196	
			142 mm	130 mm	13	1853/161	1853/197	
		14 x 14 mm	114 mm	100 mm	16	1853/162	1853/198	
			129 mm	115 mm	14	1853/163	1853/199	
			147 mm	130 mm	13	1853/164	-	
		16 x 16 mm	116 mm	100 mm	16	1853/165	1853/201	
			131 mm	115 mm	14	1853/166	1853/202	
			146 mm	130 mm	13	1853/167	1853/203	
40 x 8 mm		12 x 12 mm	112 mm	100 mm	17	1853/168	1853/204	
			127 mm	115 mm	15	1853/169	1853/205	
			142 mm	130 mm	13	1853/170	1853/206	
		14 x 14 mm	114 mm	100 mm	16	1853/171	1853/207	
			129 mm	115 mm	14	1853/172	1853/208	
			147 mm	130 mm	13	1853/173	1853/209	
		16 x 16 mm	116 mm	100 mm	16	1853/174	1853/210	
			131 mm	115 mm	14	1853/175	1853/211	
			146 mm	130 mm	13	1853/176	1853/212	
30 x 8 mm		12 mm	112 mm	100 mm	17	1853/177	-	
			127 mm	115 mm	15	1853/178	1853/214	
			142 mm	130 mm	13	1853/179	1853/215	
		14 mm	114 mm	100 mm	16	1853/180	1853/216	
			129 mm	115 mm	14	1853/181	1853/217	
			147 mm	130 mm	13	1853/182	1853/218	
		16 mm	116 mm	100 mm	16	1853/183	1853/219	
			131 mm	115 mm	14	1853/184	1853/220	
			146 mm	130 mm	13	1853/185	1853/221	
40 x 8 mm		12 mm	112 mm	100 mm	17	1853/186	1853/222	
			127 mm	115 mm	15	1853/187	1853/223	
			142 mm	130 mm	13	-	1853/224	
		14 mm	114 mm	100 mm	16	1853/189	1853/225	
			129 mm	115 mm	14	1853/190	1853/226	
			147 mm	130 mm	13	1853/191	1853/227	
		16 mm	116 mm	100 mm	16	1853/192	1853/228	
			131 mm	115 mm	14	1853/193	1853/229	
			146 mm	130 mm	13	1853/194	-	

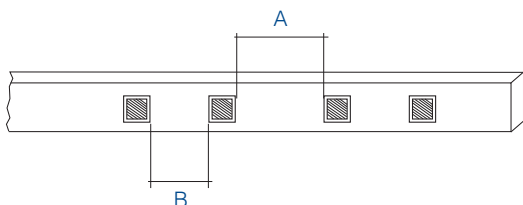

L 2.000 mm approx. - circa

Section Sezione	Hole Foro	Hole for Foro per	Distance Luce A	No. of A spaces Numero spazi A	Distance Luce B	No. of B spaces Numero spazi B	Plain Liscio
							Art.
35 x 8 mm		15 x 15 mm	115 mm	10	65 mm	9	GD128/20



Handrail - Corrimano
Art.114/10/S

51.000 km

of pierced bars have been
manufactured by our factories to
date. The circumference of the Earth
is "only" 40,075 km

di barre forate sono state prodotte
fino ad oggi nei nostri stabilimenti.
La circonferenza della Terra
è di "soli" 40.075 km

COLD PUNCHED - FORATI A FREDDO

Section Sezione	Hole Foro	Hole for Foro per	Pitch Interasse	Distance Luce	Hole N. N. Fori	Plain Liscio	Length Lunghezza
						Art.	
40 x 8 mm		14 x 14 mm	140	120 mm	14	1360/12	2070 mm
40 x 8 mm		16 x 16 mm	143	120 mm	14	1360/13	2110 mm



Section - Sezione	For hole - Per Foro	Pitch - Interasse	Holes Nr. - N. Fori	Art.
30 x 20 x 2 mm	Ø 12 mm	125 mm	23	1852/42
30 x 20 x 2 mm	Ø 14 mm	125 mm	23	1852/49
30 x 20 x 2 mm	□ 12 mm	125 mm	23	1852/44
30 x 20 x 2 mm	□ 14 mm	125 mm	23	1852/50
40 x 20 x 2 mm	Ø 12 mm	125 mm	23	1852/57
40 x 20 x 2 mm	Ø 14 mm	125 mm	23	1852/58
40 x 20 x 2 mm	Ø 16 mm	125 mm	23	1852/59
40 x 20 x 2 mm	□ 12 mm	125 mm	23	1852/60
40 x 20 x 2 mm	□ 14 mm	125 mm	23	1852/61
40 x 20 x 2 mm	□ 16 mm	125 mm	23	1852/62
50 x 25 x 2 mm	Ø 12 mm	125 mm	23	1852/81
50 x 25 x 2 mm	Ø 14 mm	125 mm	23	1852/82
50 x 25 x 2 mm	Ø 16 mm	125 mm	23	1852/83
50 x 25 x 2 mm	□ 12 mm	125 mm	23	1852/84
50 x 25 x 2 mm	□ 14 mm	125 mm	23	1852/85
50 x 25 x 2 mm	□ 16 mm	125 mm	23	1852/86

L 3.000 mm approx. - circa



Plain - Liscio
Plain tube with through holes
Tubo liscio con fori passanti

Section - Sezione	For hole - Per Foro	Pitch - Interasse	Holes Nr. - N. Fori	Art.
30 x 20 x 2 mm	Ø 12 mm	125 mm	23	1852/41
30 x 20 x 2 mm	Ø 14 mm	125 mm	23	1852/51
30 x 20 x 2 mm	□ 12 mm	125 mm	23	1852/43
30 x 20 x 2 mm	□ 14 mm	125 mm	23	1852/52
40 x 20 x 2 mm	Ø 12 mm	125 mm	23	1852/63
40 x 20 x 2 mm	Ø 14 mm	125 mm	23	1852/64
40 x 20 x 2 mm	Ø 16 mm	125 mm	23	1852/65
40 x 20 x 2 mm	□ 12 mm	125 mm	23	1852/66
40 x 20 x 2 mm	□ 14 mm	125 mm	23	1852/67
40 x 20 x 2 mm	□ 16 mm	125 mm	23	1852/68
50 x 25 x 2 mm	Ø 12 mm	125 mm	23	1852/87
50 x 25 x 2 mm	Ø 14 mm	125 mm	23	1852/88
50 x 25 x 2 mm	Ø 16 mm	125 mm	23	1852/89
50 x 25 x 2 mm	□ 12 mm	125 mm	23	1852/90
50 x 25 x 2 mm	□ 14 mm	125 mm	23	1852/91
50 x 25 x 2 mm	□ 16 mm	125 mm	23	1852/92

L 3.000 mm approx. - circa



Plain - Liscio
Plain tube with blind holes
Tubo liscio con fori ciechi

Section - Sezione	For hole - Per Foro	Pitch - Interasse	Holes Nr. - N. Fori	Art.
30 x 20 x 2 mm	Ø 12 mm	125 mm	23	1852/46
30 x 20 x 2 mm	Ø 14 mm	125 mm	23	1852/53
30 x 20 x 2 mm	□ 12 mm	125 mm	23	1852/48
30 x 20 x 2 mm	□ 14 mm	125 mm	23	1852/54
40 x 20 x 2 mm	Ø 12 mm	125 mm	23	1852/69
40 x 20 x 2 mm	Ø 14 mm	125 mm	23	1852/70
40 x 20 x 2 mm	Ø 16 mm	125 mm	23	1852/71
40 x 20 x 2 mm	□ 12 mm	125 mm	23	1852/72
40 x 20 x 2 mm	□ 14 mm	125 mm	23	1852/73
40 x 20 x 2 mm	□ 16 mm	125 mm	23	1852/74
50 x 25 x 2 mm	Ø 12 mm	125 mm	23	1852/93
50 x 25 x 2 mm	Ø 14 mm	125 mm	23	1852/94
50 x 25 x 2 mm	Ø 16 mm	125 mm	23	1852/95
50 x 25 x 2 mm	□ 12 mm	125 mm	23	1852/96
50 x 25 x 2 mm	□ 14 mm	125 mm	23	1852/97
50 x 25 x 2 mm	□ 16 mm	125 mm	23	1852/98

L 3.000 mm approx. - circa



Hammered on the edges - Battuto sugli spigoli
Hammered tube with through holes
Long hammering
Tubo spigolato con fori passanti
Spigolatura allungata

Section - Sezione	For hole - Per Foro	Pitch - Interasse	Holes Nr. - N. Fori	Art.
30 x 20 x 2 mm	Ø 12 mm	125 mm	23	1852/45
30 x 20 x 2 mm	Ø 14 mm	125 mm	23	1852/55
30 x 20 x 2 mm	□ 12 mm	125 mm	23	1852/47
30 x 20 x 2 mm	□ 14 mm	125 mm	23	1852/56
40 x 20 x 2 mm	Ø 12 mm	125 mm	23	1852/75
40 x 20 x 2 mm	Ø 14 mm	125 mm	23	1852/76
40 x 20 x 2 mm	Ø 16 mm	125 mm	23	1852/77
40 x 20 x 2 mm	□ 12 mm	125 mm	23	1852/78
40 x 20 x 2 mm	□ 14 mm	125 mm	23	1852/79
40 x 20 x 2 mm	□ 16 mm	125 mm	23	1852/80
50 x 25 x 2 mm	Ø 12 mm	125 mm	23	1852/99
50 x 25 x 2 mm	Ø 14 mm	125 mm	23	1852/100
50 x 25 x 2 mm	Ø 16 mm	125 mm	23	1852/101
50 x 25 x 2 mm	□ 12 mm	125 mm	23	1852/102
50 x 25 x 2 mm	□ 14 mm	125 mm	23	1852/103
50 x 25 x 2 mm	□ 16 mm	125 mm	23	1852/104

L 3.000 mm approx. - circa



Hammered on the edges - Battuto sugli spigoli
Hammered tube with blind holes Long hammering
Tubo spigolato con fori ciechi Spigolatura allungata

● Holes for - Fori per Ø 30 mm

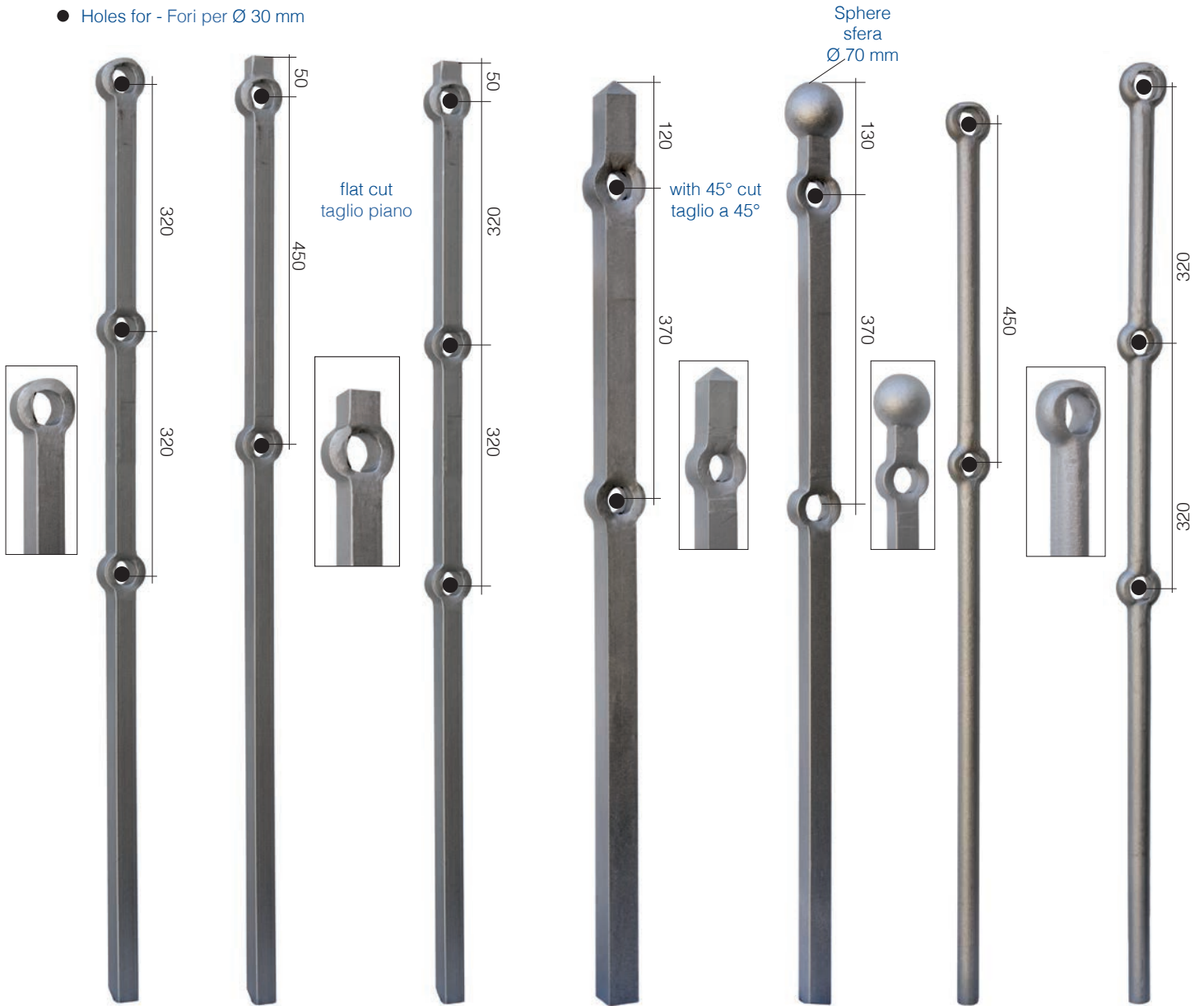

Round hole
Foro tondo

Art. 200/12
Ø 30 x 30 mm
H 1200 mm

Round hole
Foro tondo

Art. 200/14
Ø 30 x 30 mm
H 1200 mm

Round hole
Foro tondo

Art. 200/16
Ø 30 x 30 mm
H 1200 mm
Art. 200/15
Ø 40 x 40 mm
H 1200 mm

Round hole
Foro tondo

Art. 200/9
Ø 30 x 30 mm
H 1100 mm
Art. 200/8
Ø 40 x 40 mm
H 1100 mm

Round hole
Foro tondo

Art. 200/7
Ø 30 x 30 mm
H 1100 mm

Round hole
Foro tondo

Art. 200/5
Ø 30 mm
H 1100 mm

Round hole
Foro tondo

Art. 200/18
Ø 30 mm
H 1200 mm

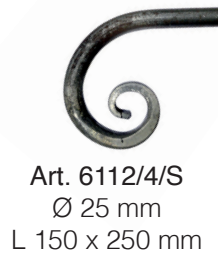
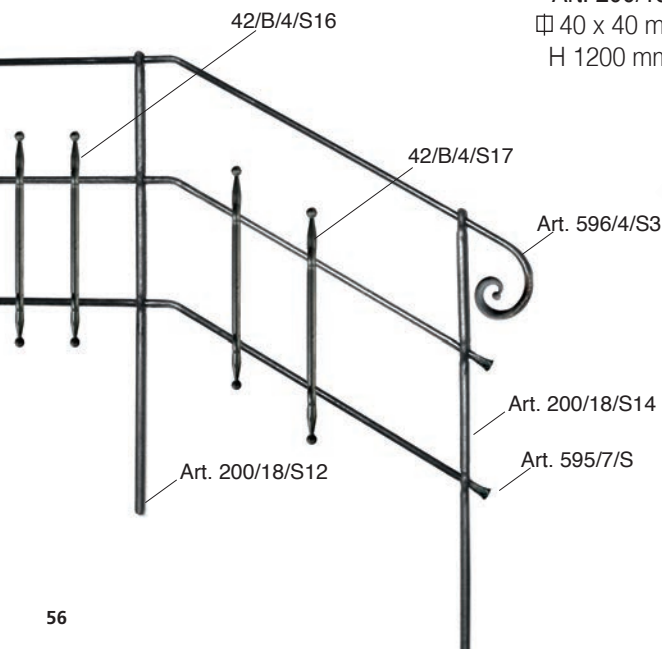

Art. 596/4/S3
Ø 25 mm
L 150 x H 300 mm



Art. 595/7/S
Ø 20 mm
H 150 mm



Round hole
Foro tondo

Art. 42/B/4/S16
Ø 22 mm
H 540 mm

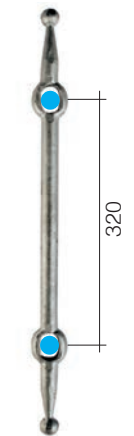

Oval hole
Foro ovale

Art. 42/B/4/S17
Ø 22 mm
H 540 mm

- upper hole for Ø 25 mm
foro superiore per Ø 25 mm
- lower holes for Ø 22 mm
fori inferiori per Ø 22 mm

- upper hole for Ø 30 mm
foro superiore per Ø 30 mm
- lower holes for Ø 25 mm
fori inferiori per Ø 25 mm

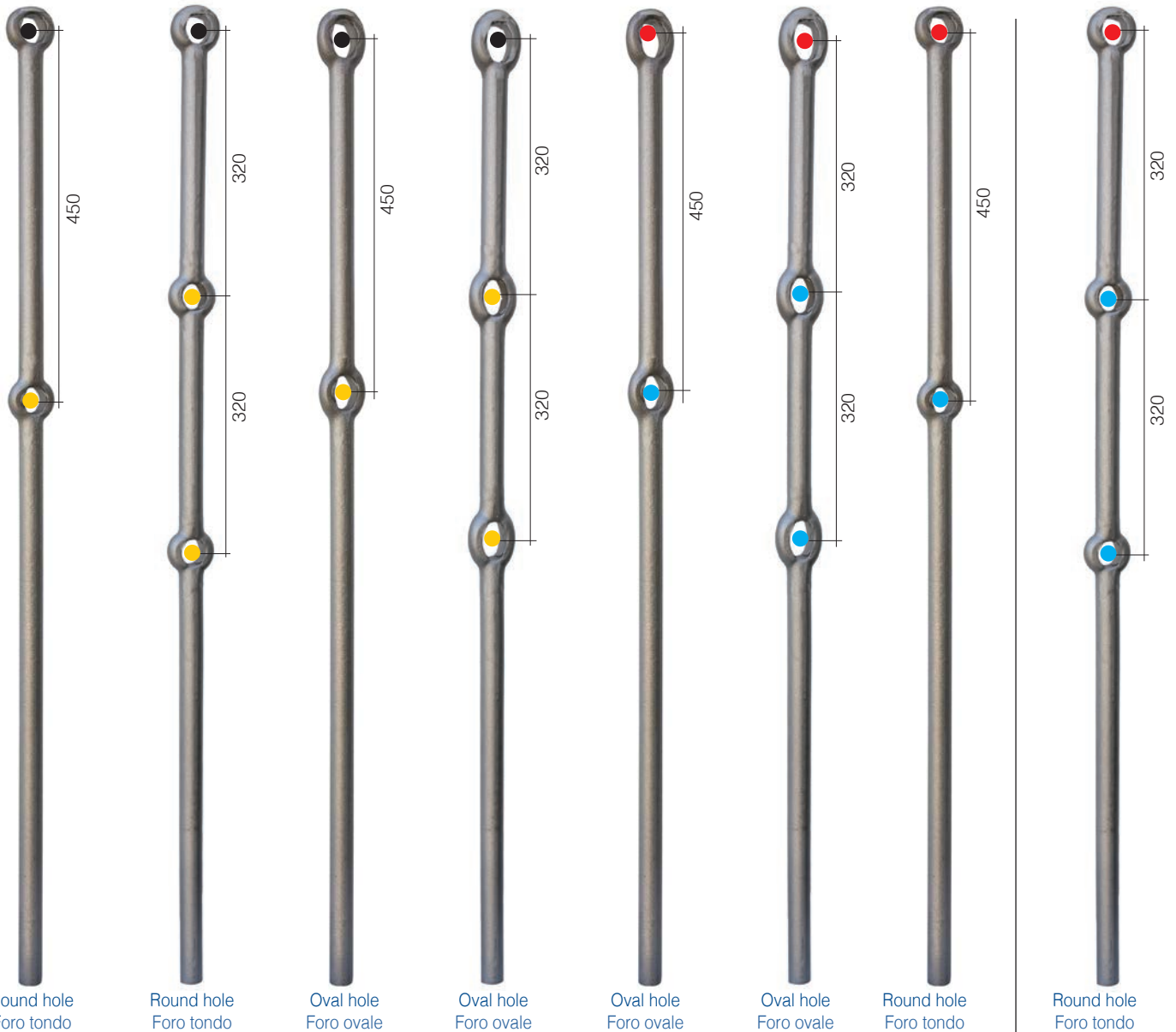

Round hole
Foro tondo

Round hole
Foro tondo

Oval hole
Foro ovale

Oval hole
Foro ovale

Oval hole
Foro ovale

Oval hole
Foro ovale

Round hole
Foro tondo

Round hole
Foro tondo

Art. 200/5/S45
Ø 30 mm
H 1200 mm

Art. 200/18/S13
Ø 30 mm
H 1200 mm

Art. 200/5/S46
Ø 30 mm
H 1200 mm

Art. 200/18/S24
Ø 30 mm
H 1200 mm

Art. 200/5/S44
Ø 25 mm
H 1200 mm

Art. 200/18/S14
Ø 25 mm
H 1200 mm

Art. 200/5/S28
Ø 25 mm
H 1200 mm

Art. 200/18/S12
Ø 25 mm
H 1200 mm

NEW



01

Raw stainless steel
Acciaio inox grezzo

NEW



02

Pickled and electropolished
stainless steel
Acciaio inox decappato
ed elettrolucidato

01

Art. 1415/1
Ø 25 mm
H 1200 mm

NEW

02

Art. 1415/1X
Ø 25 mm
H 1200 mm

NEW

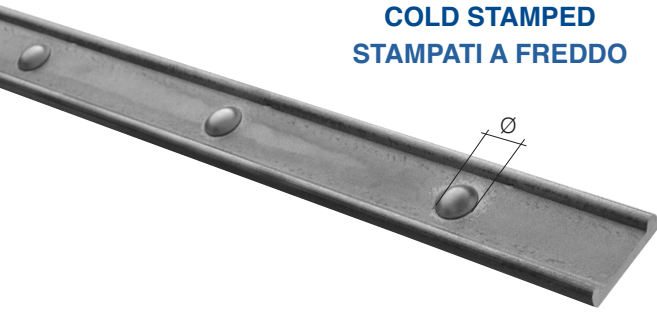
COLD STAMPED
STAMPATI A FREDDOHOT ROLLED PROFILES
PROFILI LISCI LAMINATI A CALDO

Section - Sezione	Art.	Length - Lunghezza
25 x 8 mm	158/49	3000 mm
	158/52	6000 mm
30 x 8 mm	158/50	3000 mm
	158/53	6000 mm
40 x 8 mm	158/51	3000 mm
	158/54	6000 mm

L 2.000 mm approx. - circa

Section Sezione	Rivet Ribattino	Pitch - Interasse 112 mm	Pitch - Interasse 122 mm	Pitch - Interasse 127 mm	Pitch - Interasse 132 mm
		Art.	Art.	Art.	Art.
30 x 8 mm	Ø 11 mm	1852/1	1852/2	1852/3	1852/4
40 x 8 mm	Ø 16 mm	1852/5	1852/6	1852/7	1852/8

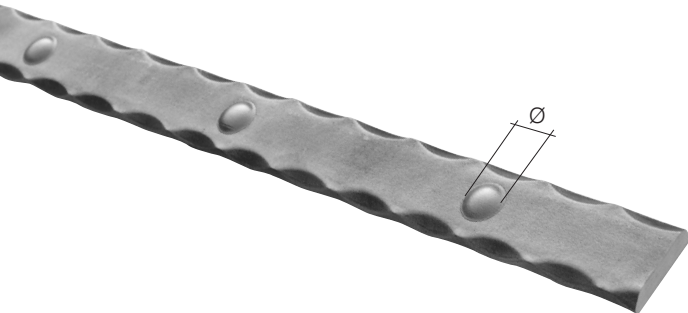

L 2.000 mm approx. - circa

Spigolato su 2 angoli - Hammered on 2 corners

Section / Sezione	Rivet Ribattino	Pitch - Interasse 112 mm	Pitch - Interasse 122 mm	Pitch - Interasse 127 mm	Pitch - Interasse 132 mm
		Art.	Art.	Art.	Art.
25 x 6 mm	Ø 16 mm	1852/9	1852/10	1852/11	1852/12
25 x 8 mm	Ø 16 mm	1852/13	1852/14	1852/15	1852/16
30 x 6 mm	Ø 16 mm	1852/17	1852/18	1852/19	1852/20
30 x 8 mm	Ø 16 mm	1852/21	1852/22	1852/23	1852/24

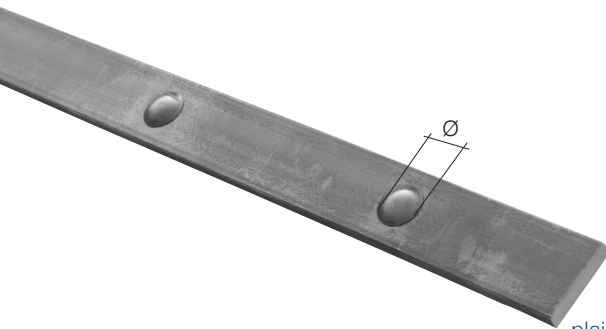

plain - liscio

L 2.000 mm approx. - circa

Section / Sezione	Rivet Ribattino	Pitch - Interasse 112 mm	Pitch - Interasse 122 mm	Pitch - Interasse 127 mm	Pitch - Interasse 132 mm
		Art.	Art.	Art.	Art.
25 x 6 mm	Ø 16 mm	1852/25	1852/26	1852/27	1852/28
25 x 8 mm	Ø 16 mm	-	1852/30	1852/31	1852/32
30 x 6 mm	Ø 16 mm	1852/33	1852/34	1852/35	1852/36
30 x 8 mm	Ø 16 mm	1852/37	-	1852/39	1852/40



Art. 118/2
for-per 614/5 - 614/6
□ 14 x 14 mm
L 3000 mm



Art. 614/4
□ 14 x 14 mm
pitch-interasse 125 mm
L 2.000 mm
n. 15 bushes-borchie

**HOT STAMPED
STAMPATI A CALDO**



plain - liscio



hammered - spigolato

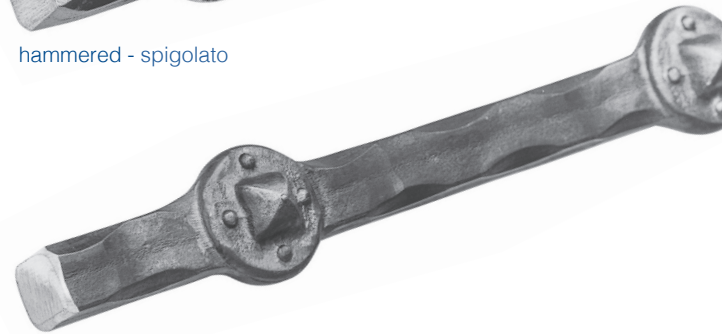

hammered - spigolato

Art. 611/1
□ 14 x 14 mm
L 570 mm
n. 3 borchie/bushes

Art. 611/2
□ 14 x 14 mm
L 830 mm
n. 5 borchie/bushes

Art. 611/3
□ 14 x 14 mm
L 1090 mm
n. 7 borchie/bushes



Art. 614/5
□ 14 x 14 mm
pitch-interasse 125 mm
L 2.000 mm
n. 15 bushes-borchie

Art. 614/6
□ 14 x 14 mm
pitch-interasse 125 mm
L 2.000 mm
n. 15 bushes-borchie

Pag.
18

In section 1
Long bars you'll
find the profiles
to match

Nel capitolo 1
Barre lunghe
troverai i profili
da abbinare

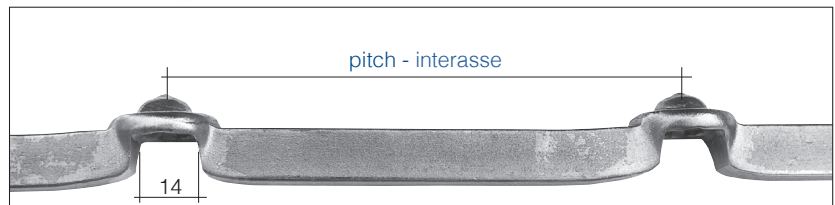



Art. 41/2
□ 30 x 8 mm
L 2000 mm



Art. 40/B/10
□ 20 x 6 mm

L 2.000 mm - pitch - interasse 180 mm
holes - fori Ø 8,5 mm

pitch - interasse



Art. 40/B/6
□ 10 x 10 mm
L 2000 mm

Art. 40/B/7
□ 14 x 14 mm
L 2000 mm



Plain
Liscio

Art. 39/2
□ 8 x 8 mm
L 1600 mm



Bark effect
Corteccia



Art. 1356/2
□ 12 x 12 mm
L 1750 mm



Hammered
Spigliato

Art. 597/5
□ 16 x 6 mm
L 1600 mm



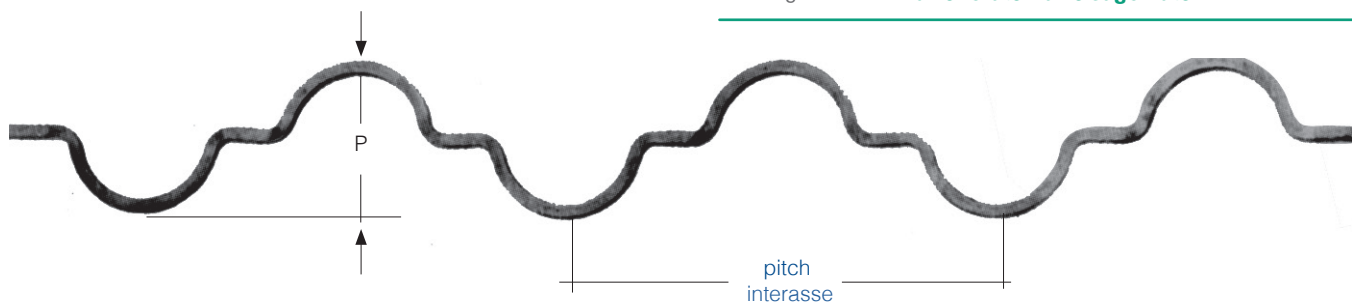

 Plain Liscio	Section - Sezione	Art.	Pitch - Interasse	P	Length - Lunghezza
	□ 8 x 8 mm	38/1	240 mm	84 mm	1600 mm
	▤ 12 x 6 mm	38/2	240 mm	80 mm	1600 mm
	□ 10 x 10 mm	38/3	250 mm	95 mm	1600 mm
	□ 12 x 12 mm	38/4	260 mm	100 mm	1600 mm
	∅ 10 mm	1846/1	180 mm	100 mm	2000 mm

 Hammered Spigolato	□ 12 x 12 mm	621/1	260 mm	100 mm	1600 mm
--	--------------	-------	--------	--------	---------

 Bark effect Corteccia	□ 12 x 12 mm	1358/1	260 mm	100 mm	1600 mm
---	--------------	--------	--------	--------	---------

 Diamond Diamantato	□ 12 x 12 mm	1358/2	260 mm	100 mm	1600 mm
---	--------------	--------	--------	--------	---------

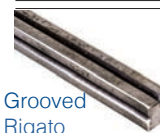
 Grooved Rigato	□ 12 x 12 mm	620/1	260 mm	100 mm	1600 mm
--	--------------	-------	--------	--------	---------

L 6000 mm - pitch - interasse 178 mm



Stamped on the corners
Stampate sullo spigolo

Art. 40/1
□ 14 x 14 mm

Art. 40/2
□ 12 x 12 mm

Art. 40/3
□ 10 x 10 mm

Art. 40/4
□ 8 x 8 mm

Art. 40/5
∅ 12 mm



Art. 40/A/1
□ 12 x 12 mm

L 6000 mm - pitch - interasse 140 mm

Stampated on the side
Stampate sul lato

Art. 40/A/1/S
□ 14 x 14 mm

L 6000 mm - pitch - interasse 140 mm

Stampated on the side
Stampate sul lato

BEST PRICE



Art. 40/A/2
□ 12 x 12 mm

L 6000 mm - pitch - interasse 300 mm

Stampated on the side
Stampate sul lato



Art. 40/A/3
□ 12 x 12 mm

L 6000 mm - pitch - interasse 200 mm

Stampated on the side
Stampate sul lato





Overthrows

Cimase

Arteferro overthrow are decorative elements that can be used as the crowning points of a fence, a gate, a door or a window. From the simplest to the most elaborate, every Arteferro overthrow is ready for installation and is an ideal solution for combining fast installation and aesthetic results.

Le cimase Arteferro sono elementi decorativi che possono fare da coronamento per una recinzione, un cancello, un portone o una finestra. Dalla più semplice alla più elaborata, ogni cimasa Arteferro è pronta per l'installazione e rappresenta la soluzione ideale per combinare rapidità di posa e risultato estetico.

arteferro





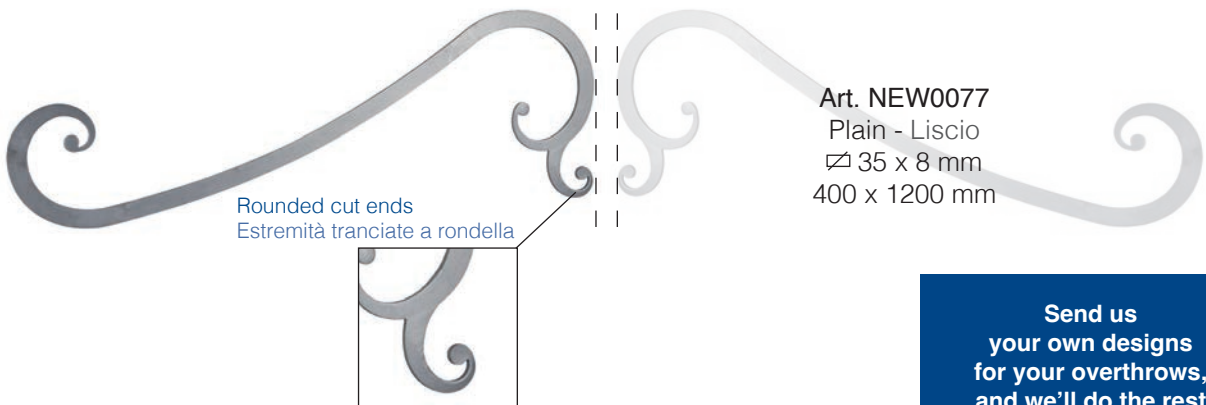
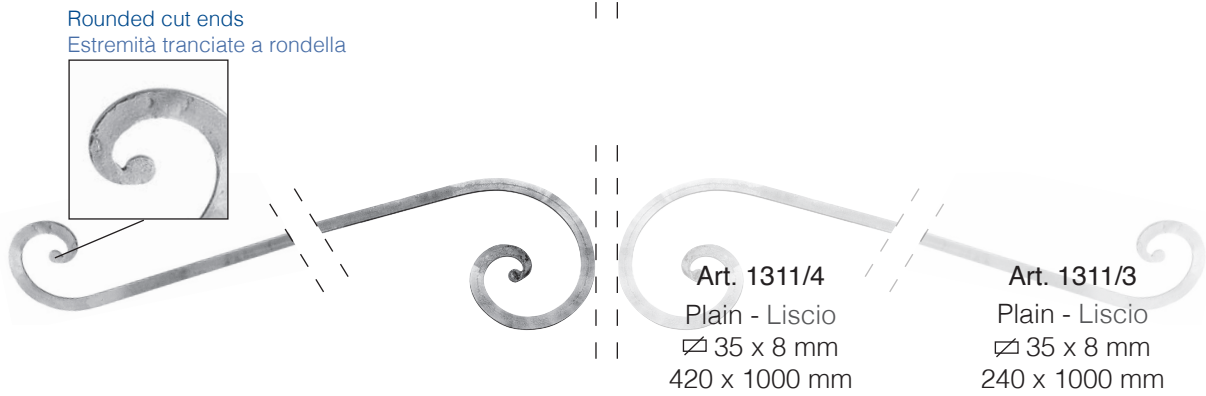
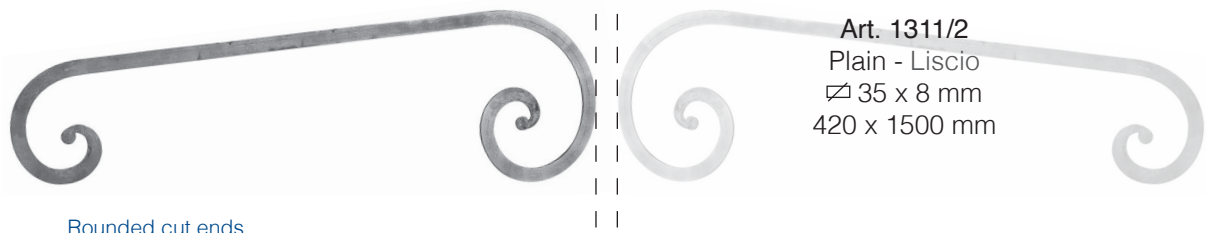
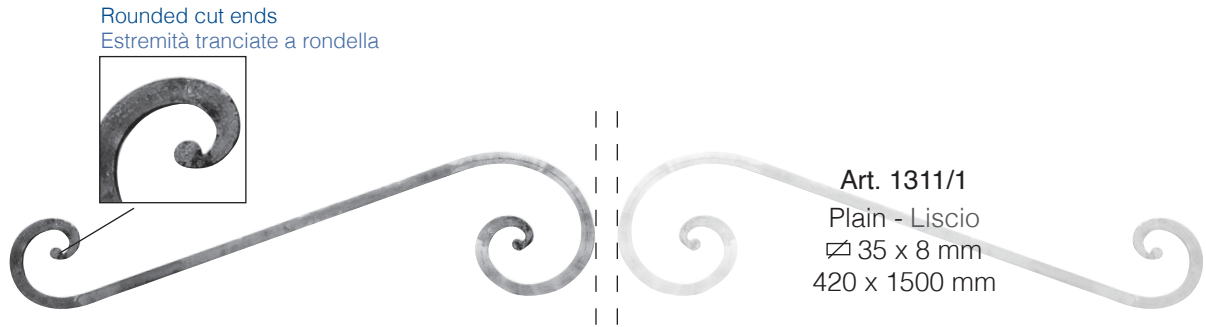

Send us
your own designs
for your overthrows,
and we'll do the rest
for you!

Inviaci il disegno
della tua cimasa,
la faremo apposta
per te!

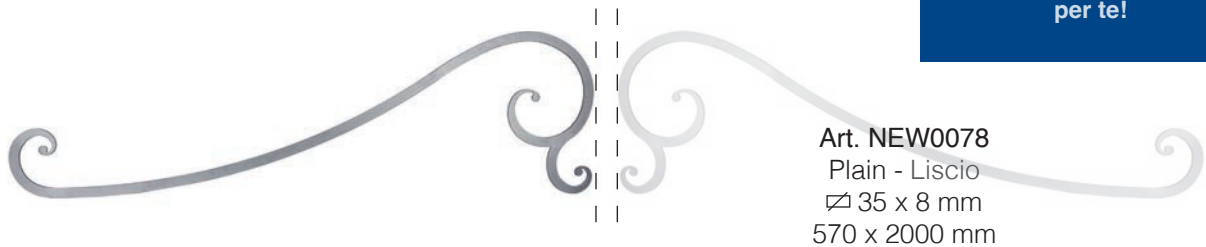

Cut ends with dovetail
Estremità tranciate
a coda di rondine

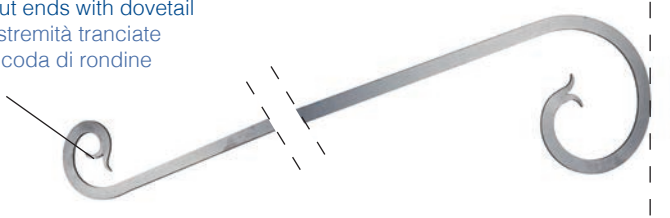

Art. NEW0080
Plain - Liscio
∅ 35 x 8 mm
400 x 1300 mm

Art. NEW0079
Plain - Liscio
∅ 35 x 8 mm
250 x 700 mm

X
↓
↑

Rounded cut ends
Estremità tranciate a rondella



Art. NEW0081
Plain - Liscio
∅ 35 x 8 mm
400 x 2100 mm
X 130 mm

Art. NEW0082
Plain - Liscio
∅ 35 x 8 mm
400 x 2000 mm

A

L 2000 mm
H 500 mm

B

L 1200 mm
H 250 mm

Plain Liscio	Section Sezione	Mod.	Art	Mod.	Art
	∅ 30 x 8 mm	A	1827/5	B	1827/11
	∅ 40 x 8 mm		1827/6		1827/12
Hammered on 4 corners Spigolato 4 angoli	Section Sezione	Mod.	Art	Mod.	Art
	∅ 30 x 8 mm	A	1827/1	B	1827/7
	∅ 40 x 8 mm		1827/2		1827/8
hammered on 4 corners and 2 sides magliato e spigolato su entrambi i lati	Section Sezione	Mod.	Art	Mod.	Art
	∅ 30 x 8 mm	A	1827/3	B	-
	∅ 40 x 8 mm		1827/4		1827/10

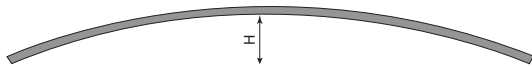

Section Sezione	L 1450 mm H 260 mm Art.	L 1950 mm H 260 mm Art.	L 2450 mm H 260 mm Art.	L 2950 mm H 260 mm Art.
⌀ 30 x 30 x 2,5 mm	16211/12	16211/8	16211/4	100088
⊘ 30 x 40 x 2,5 mm	16211/13	16211/9	16211/5	16211/2
⊘ 30 x 50 x 2,5 mm	16211/13	16211/10	16211/6	-
⌀ 40 x 40 x 2,5 mm	16211/15	16211/11	16211/7	-

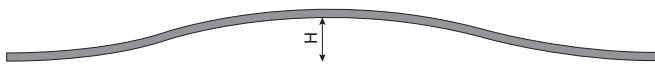

Section Sezione	L 1300 mm H 230 mm Art.	L 1460 mm H 200 mm Art.	L 1960 mm H 200 mm Art.	L 2460 mm H 200 mm Art.	L 2960 mm H 200 mm Art.
⌀ 30 x 30 x 2,5 mm	100091	16212/12	16212/8	16212/4	100090
⊘ 30 x 40 x 2,5 mm	100092	16212/13	16212/9	16212/5	16212/2
⊘ 30 x 50 x 2,5 mm	16223/2	16212/14	16212/10	16212/6	16222/2
⌀ 40 x 40 x 2,5 mm	100093	16212/15	16212/11	16212/7	16212/3

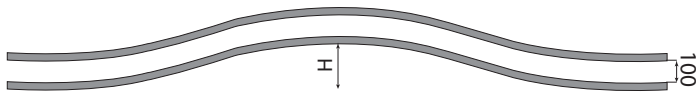

Section Sezione	L 2900 mm H 200 mm Art.	L 2900 mm H 200 mm Art.
⊘ 30 x 8 mm	16270 Top-superiore	16271 Bottom-inferiore

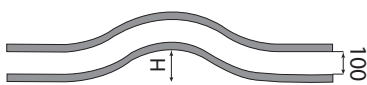

Section Sezione	L 1400 mm H 200 mm Art.	L 1400 mm H 200 mm Art.
⊘ 30 x 8 mm	16260 Top-superiore	16261 Bottom-inferiore

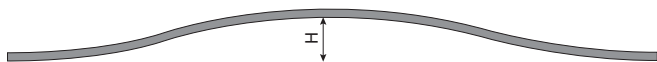

Section Sezione	L 2960 mm H 200 mm Art.
⊘ 30 x 50 x 2,5 mm	16242



plain
liscio

NEW

Art. 1828/1 ∅ 30 x 8 mm 500 x 2500 mm	Art. 1828/3 ∅ 50 x 8 mm 500 x 2500 mm
Art. 1828/2 ∅ 40 x 8 mm 500 x 2500 mm	Art. 1828/4 ∅ 80 x 8 mm 500 x 2500 mm

Example of applications
Esempi di applicazione

NEW

Art. 1828/5 ∅ 30 x 8 mm 500 x 2500 mm	Art. 1828/7 ∅ 50 x 8 mm 500 x 2500 mm
Art. 1828/6 ∅ 40 x 8 mm 500 x 2500 mm	Art. 1828/8 ∅ 80 x 8 mm 500 x 2500 mm

Example of applications
Esempi di applicazione

NEW

Art. 1828/9 ∅ 30 x 8 mm 500 x 2500 mm	Art. 1828/11 ∅ 50 x 8 mm 500 x 2500 mm
Art. 1828/10 ∅ 40 x 8 mm 500 x 2500 mm	Art. 1828/12 ∅ 80 x 8 mm 500 x 2500 mm

Example of applications
Esempi di applicazione

NEW

Art. 1828/13 ∅ 30 x 8 mm 500 x 2500 mm	Art. 1828/15 ∅ 50 x 8 mm 500 x 2500 mm
Art. 1828/14 ∅ 40 x 8 mm 500 x 2500 mm	Art. 1828/16 ∅ 80 x 8 mm 500 x 2500 mm

Example of applications
Esempi di applicazione

plain
liscio

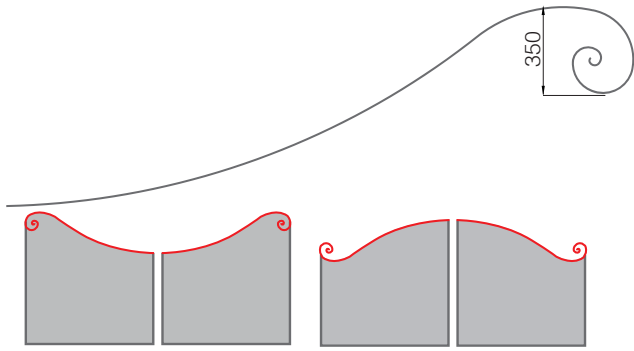

Example of applications
Esempi di applicazione

NEW

Art. 1828/17
∅ 30 x 8 mm
500 x 2500 mm
Art. 1828/18
∅ 40 x 8 mm
500 x 2500 mm

Art. 1828/19
∅ 50 x 8 mm
500 x 2500 mm
Art. 1828/20
∅ 80 x 8 mm
500 x 2500 mm

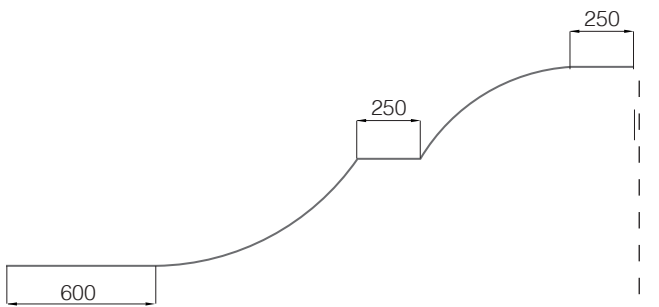

Example of applications
Esempi di applicazione

NEW

Art. 1828/21
∅ 30 x 8 mm
500 x 2500 mm
Art. 1828/22
∅ 40 x 8 mm
500 x 2500 mm

Art. 1828/23
∅ 50 x 8 mm
500 x 2500 mm
Art. 1828/24
∅ 80 x 8 mm
500 x 2500 mm

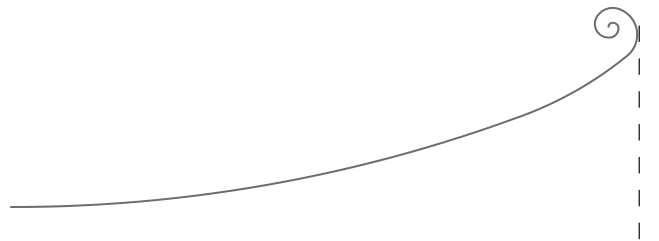

Example of applications
Esempi di applicazione

NEW

Art. 1828/29
∅ 30 x 8 mm
500 x 2500 mm
Art. 1828/30
∅ 40 x 8 mm
500 x 2500 mm

Art. 1828/31
∅ 50 x 8 mm
500 x 2500 mm
Art. 1828/32
∅ 80 x 8 mm
500 x 2500 mm

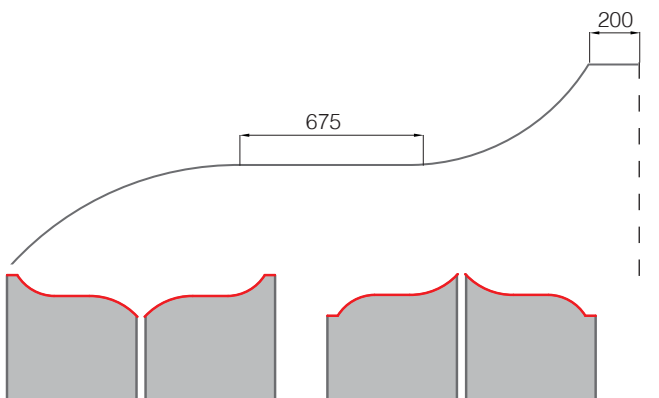

Example of applications
Esempi di applicazione

NEW

Art. 1828/33
∅ 30 x 8 mm
500 x 2500 mm
Art. 1828/34
∅ 40 x 8 mm
500 x 2500 mm

Art. 1828/35
∅ 50 x 8 mm
500 x 2500 mm
Art. 1828/36
∅ 80 x 8 mm
500 x 2500 mm

Ends welded on Art. 654/5
Estremità saldate su art. 654/5



Art. 654/5
Ø 60 mm
6 mm



Art. 653/5
30 x 8 mm
310 x 1500 mm



Art. 654/2
30 x 8 mm
310 x 1500 mm

Art. 118/A/6
30 x 8 mm
L 3000 mm



Hammered bar
on both sides
and corners
barra magliata
e spigolata su
entrambi i lati

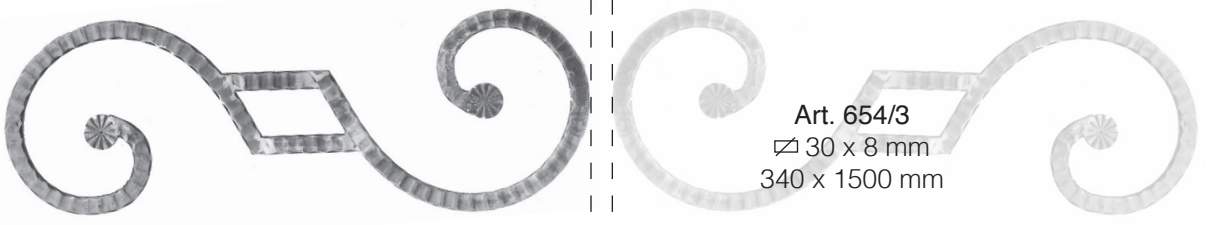

Art. 654/3
30 x 8 mm
340 x 1500 mm

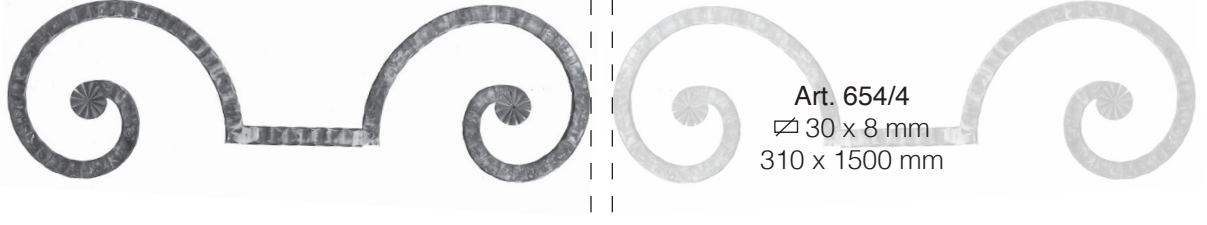

Art. 654/4
30 x 8 mm
310 x 1500 mm

Pag.
356

In section 17
you'll find
the accessories
for the gates
Nel capitolo 17
troverai
gli accessori
per i cancelli





Art. 654/5
Ø 60 mm
3/8 6 mm

Ends welded on Art. 654/5
Estremità saldate su art. 654/5

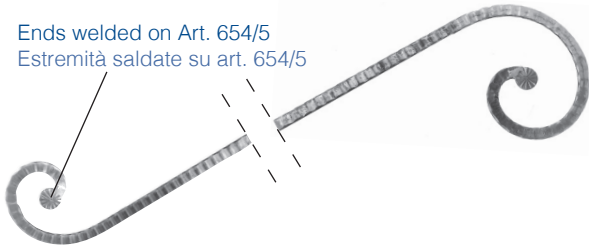

Art. 653/1
3/8 30 x 8 mm
410 x 900 mm

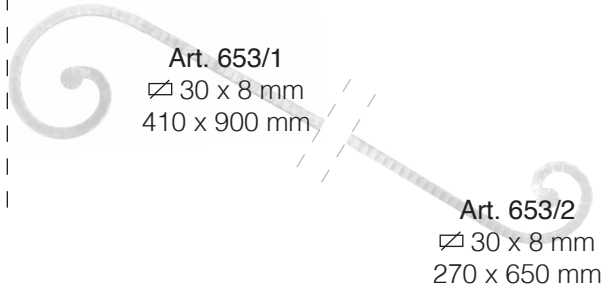

Art. 653/2
3/8 30 x 8 mm
270 x 650 mm

Art. 118/A/6
3/8 30 x 8 mm
L 3000 mm

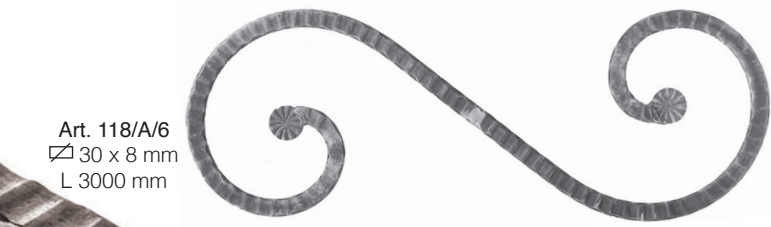

Art. 653/4
3/8 30 x 8 mm
360 x 1500 mm

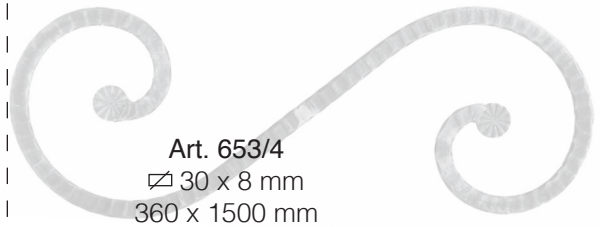

Hammered bar
on both sides
and corners
barra magliata
e spigolata su
entrambi i lati



Art. 653/3
3/8 30 x 8 mm
240 x 1500 mm

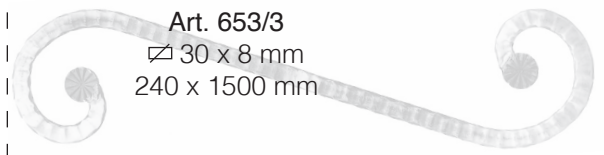

Art. 654/1
3/8 30 x 8 mm
370 x 1500 mm

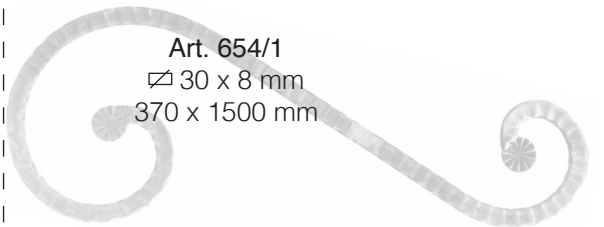



left - sinistro
Art. GD285/2
∅ 14 mm + ▧ 14 x 8 mm
700 x 1360 mm



right - destro
Art. GD285/2/S
∅ 14 mm + ▧ 14 x 8 mm
700 x 1360 mm



left - sinistro
Art. 1281/11
▧ 20 x 8 mm
310 x 1100 mm



right - destro
Art. 1281/12
▧ 20 x 8 mm
310 x 1100 mm



left - sinistro
Art. 1281/5
▧ 20 x 8 mm
430 x 1230 mm



right - destro
Art. 1281/6
▧ 20 x 8 mm
430 x 1230 mm



left - sinistro
Art. 1281/7
▧ 20 x 8 mm
250 x 750 mm



right - destro
Art. 1281/8
▧ 20 x 8 mm
250 x 750 mm

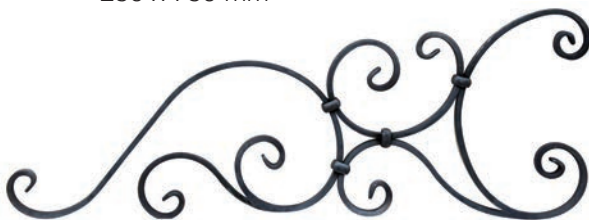

left - sinistro
Art. 1281/9
▧ 20 x 8 mm
310 x 850 mm



right - destro
Art. 1281/10
▧ 20 x 8 mm
310 x 850 mm



left - sinistro
Art. 1281/2/S2
☒ 16 x 8 mm
440 x 1260 mm



right - destro
Art. 1281/2
☒ 16 x 8 mm
440 x 1260 mm



Art. 1369/2
☒ 16 x 8 mm
L 3000 mm



left - sinistro
Art. 1281/1/S
☒ 16 x 8 mm
445 x 1300 mm



right - destro
Art. 1281/1
☒ 16 x 8 mm
445 x 1300 mm



Art. 1369/2
☒ 16 x 8 mm
L 3000 mm



left - sinistro
Art. 1281/3/S
☒ 16 x 8 mm
340 x 830 mm



right - destro
Art. 1281/3
☒ 16 x 8 mm
340 x 830 mm

Art. 1369/2
☒ 16 x 8 mm
L 3000 mm



left - sinistro
Art. 1281/4/S2
☒ 16 x 8 mm
260 x 760 mm



right - destro
Art. 1281/4
☒ 16 x 8 mm
260 x 760 mm

Art. 1369/2
☒ 16 x 8 mm
L 3000 mm







Art. 1279/4
 □ 20 x 6 mm
 235 x 720 mm

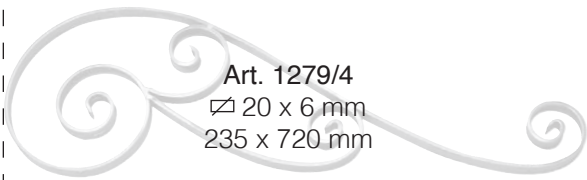

Art. 1279/3
 □ 20 x 6 mm
 190 x 450 mm

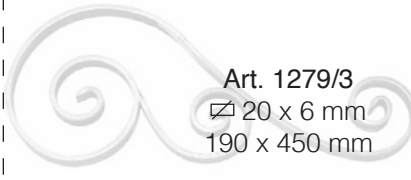

Art. 116/D/1
 □ 20 x 6 mm
 450 x 1280 mm

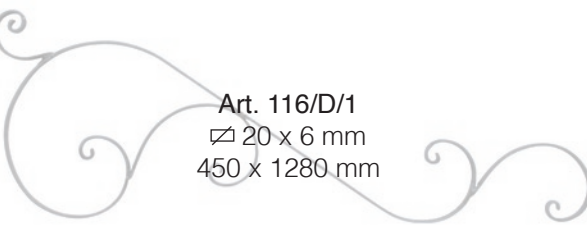

Hammered
Martellato
118/12
 □ 20 x 6 mm



with leaves - con foglie
 art. 136/3 and/e 136/4

Art. 116/D/2
 □ 20 x 6 mm
 450 x 1280 mm



Hammered
Martellato
118/12
 □ 20 x 6 mm



Art. 116/E/6
 □ 30 x 8 mm
 280 x 810 mm



We also
produce customised
overthrows

Facciamo anche
cimase su misura



Art. 1281/14
 □ 20 x 8 mm
 240 x 800 mm



Art. 116/E/2
 □ 12 x 6 mm
 240 x 1030 mm



Art. GD271/1
 □ 16 x 6 mm
 200 x 770 mm



Art. 116/E/3
 □ 20 x 8 mm
 300 x 800 mm



Art. GD271/2
 □ 16 x 6 mm
 220 x 830 mm



Art. GD271/3
 □ 16 x 6 mm
 320 x 1100 mm



Art. 696/1
 □ 16 x 8 mm
 280 x 920 mm



Art. 1280/1
 □ 20 x 6 mm
 300 x 900 mm



Art. 1280/2
 □ 12 x 6 mm
 210 x 745 mm

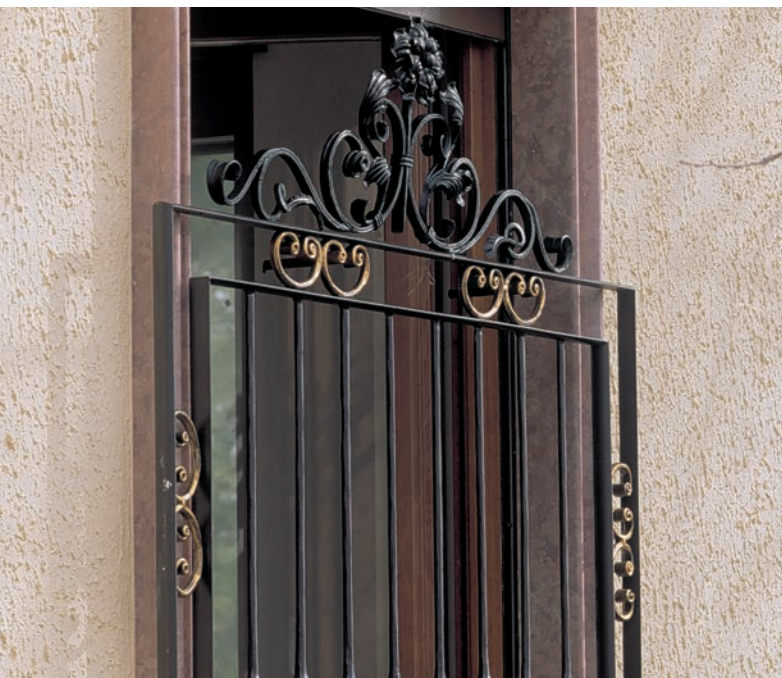

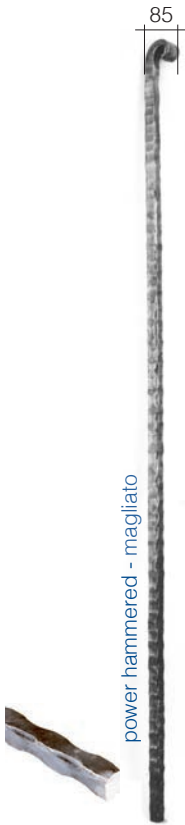

power hammered - magliato

Art. 179/9
Φ 30 x 30 mm
H 2500 mm



hammered - martellato

Art. 179/10
Φ 30 x 30 mm
H 2500 mm





Classical Pickets and Panels

Paletti e Pannelli classici

Arteferro pickets and panels are amongst the most important items in the composition of an infill of a balustrade or fence. The classic design means you can create structures with a refined taste and an unmistakable and timeless style, typical of traditional wrought iron items.

I paletti e pannelli Arteferro sono tra gli elementi più importanti nella composizione del tamponamento di un parapetto o di una recinzione. Il design classico consente di realizzare strutture dal gusto ricercato e dallo stile inconfondibile ed intramontabile, tipico dei manufatti in ferro battuto tradizionali.

arteferro



4

Classical Pickets and Panels
Paletti e Pannelli classici

A	Forged pickets	Paletti forgiati pag.80
B	Stamped pickets	Paletti coniati pag.96
C	Tube pickets	Paletti in tubo pag.110
D	Pickets with twisting	Paletti con torciglione pag.116
E	Pickets with big twisting	Paletti con torciglione grande pag.125
F	Pickets with baskets	Paletti con pigna pag.126
G	Pickets with scrolls	Paletti con ricci pag.129
H	Shaped pickets	Paletti sagomati pag.135
I	Special pickets	Paletti speciali pag.137
L	Shaped panels	Pannelli sagomati pag.139
M	"S" shaped panels	Pannelli ad "esse" pag.143
N	Panels with scrolls	Pannelli con ricci pag.150



A lot of pickets and panels have been classified to make it easier for you to find what you want quickly and easily. Starting with the central motif, you can find your article by process as well as matching decorations.

Molti paletti e pannelli sono stati classificati per dare la possibilità di trovare in modo veloce e pratico l'articolo desiderato. Parti dal motivo centrale troverai il tuo articolo con la lavorazione e i decori abbinabili.

The first forged picket in our factory was art. 98/1 and still in production

Il primo paletto forgiato nelle nostre fucine è stato l'art. 98/1 ancora oggi in produzione

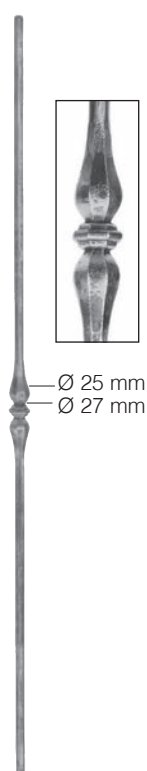

Art. 1770/1
Ø 12 mm
H 1000 mm



Art. 1771/1
Ø 12 mm
H 1000 mm

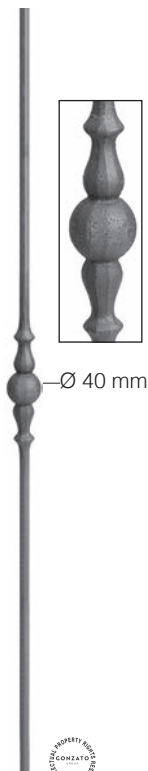

Art. 503/1
Ø 12 mm
H 1000 mm



Art. 523/1
Ø 12 mm
H 900 mm

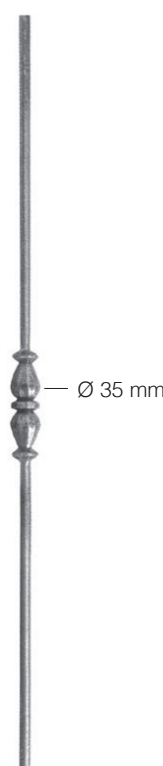

Art. 1189/3
Ø 12 mm
H 900 mm

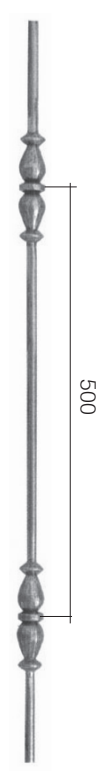

Art. 1189/4
Ø 12 mm
H 900 mm

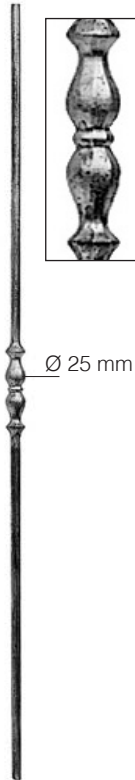

Art. 497/1/C
Ø 12 mm
H 1000 mm



Art. 497/2/C
Ø 12 mm
H 1000 mm



Art. 496/3
Ø 12 mm
140 x 1000 mm

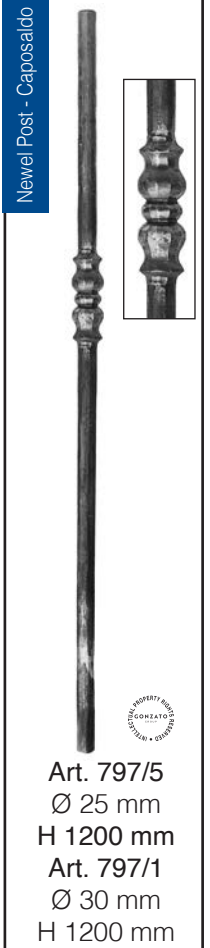

Art. 797/5
Ø 25 mm
H 1200 mm
Art. 797/1
Ø 30 mm
H 1200 mm

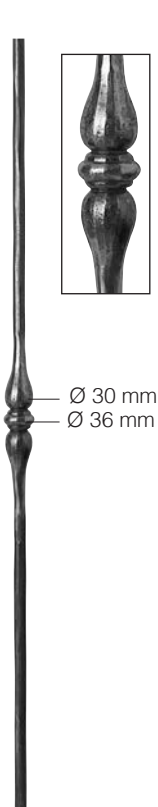

Art. 508/3/C
Ø 14 mm
H 1000 mm

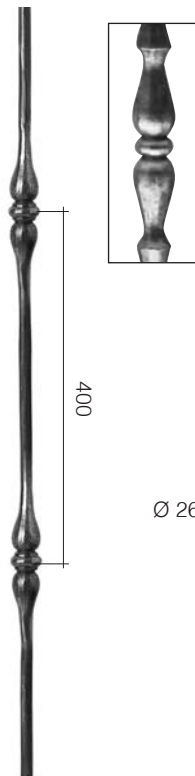

Art. 508/4/C
Ø 14 mm
H 1000 mm

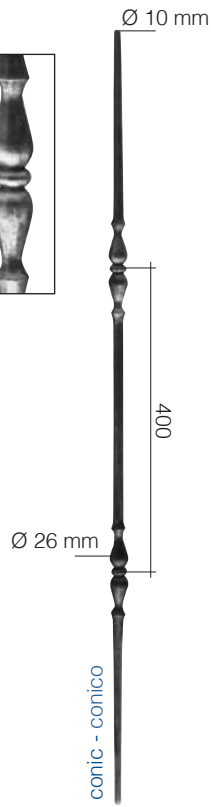

Art. 1770/9
Ø 14 mm
H 1000 mm

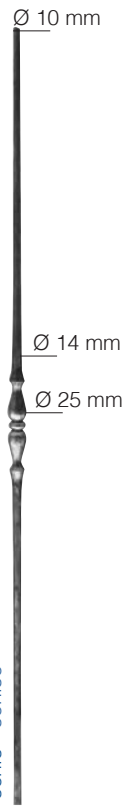

Art. 1770/10
Ø 14 mm
H 1000 mm



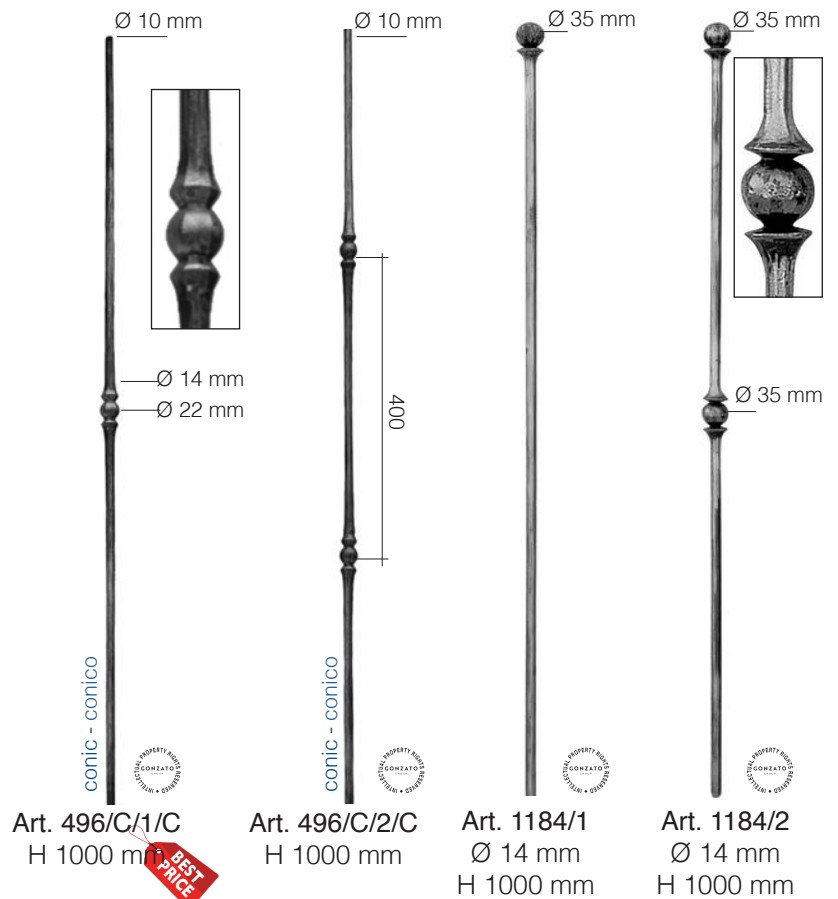
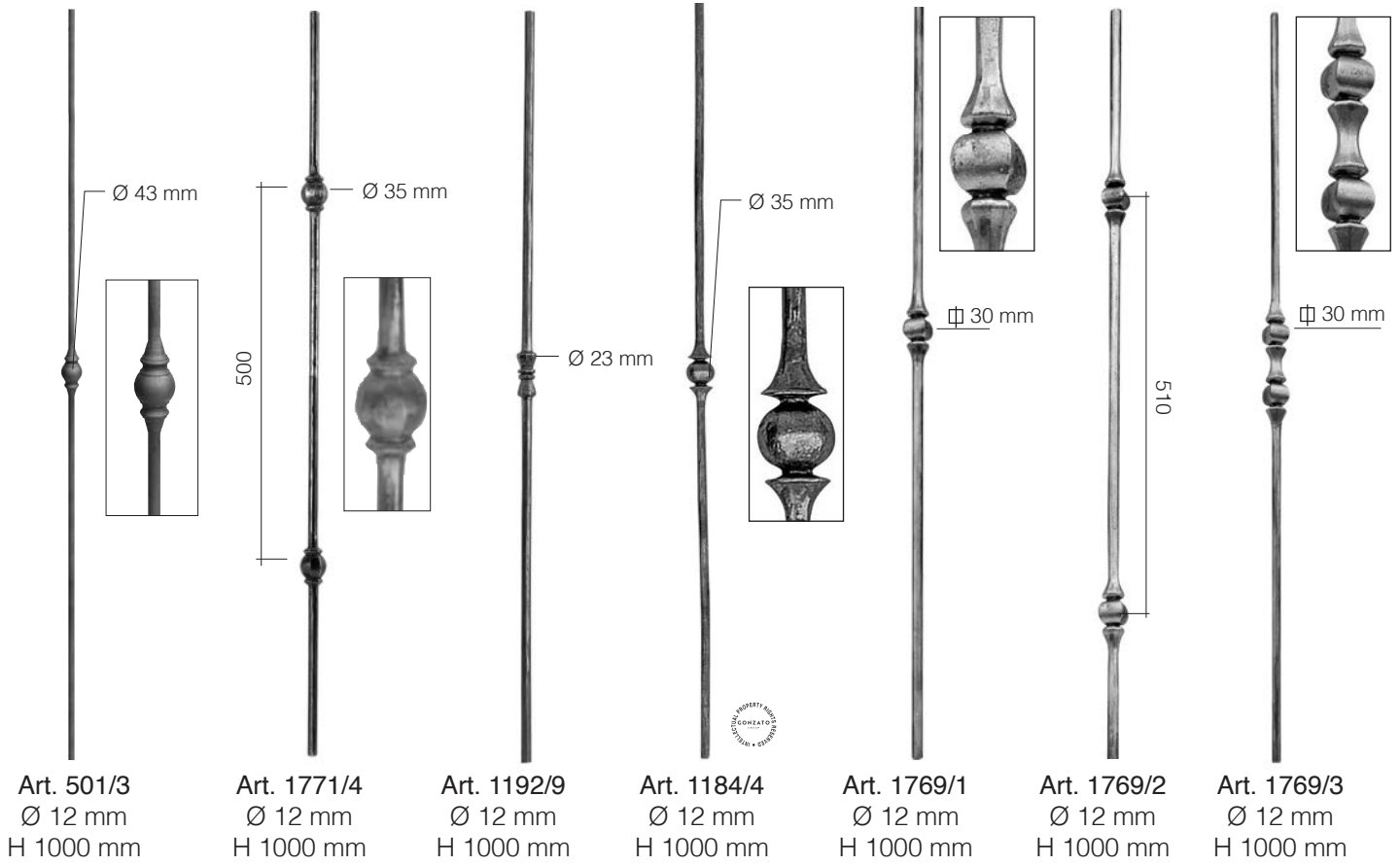



Art. 1187/4
Ø 14 mm
H 1000 mm



Art. 504/2/C
Ø 14 mm
H 1000 mm

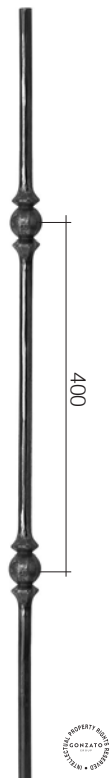

Art. 504/3/C
Ø 14 mm
H 1000 mm

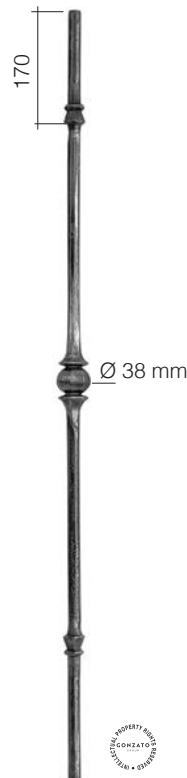

Art. 1192/7
Ø 14 mm
H 1000 mm

Newel Post - Caposaldo



Ø 60 mm

Art. 1769/5
Ø 25 mm
H 1200 mm
Art. 1769/6
Ø 30 mm
H 1200 mm

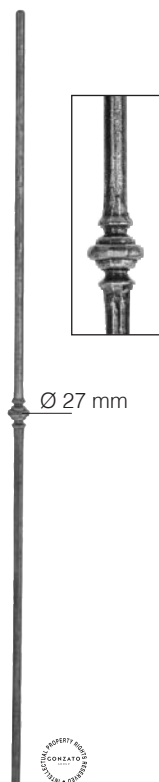

Art. 1770/2
Ø 12 mm
H 1000 mm

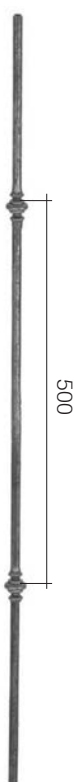

Art. 1771/2
Ø 12 mm
H 1000 mm

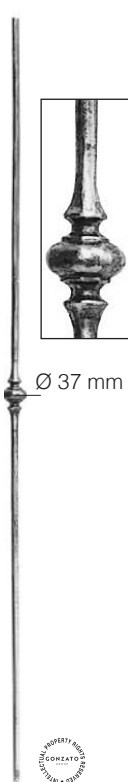

Art. 499/1/C
Ø 12 mm
H 1000 mm

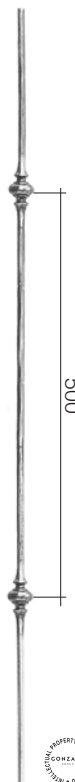

Art. 499/2/C
Ø 12 mm
H 1000 mm

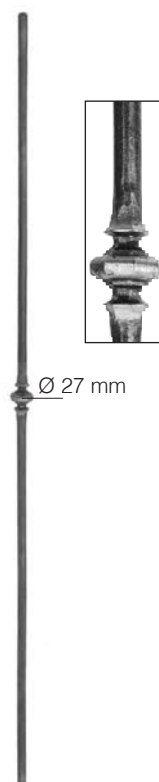

Art. 1770/3
Ø 12 mm
H 1000 mm

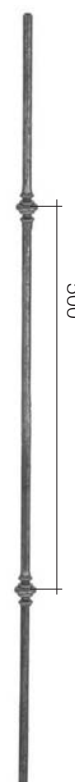

Art. 1771/3
Ø 12 mm
H 1000 mm

Newel Post - Caposaldo



Art. 797/6
Ø 25 mm
H 1200 mm
Art. 797/2
Ø 30 mm
H 1200 mm
Art. 797/7
Ø 40 mm

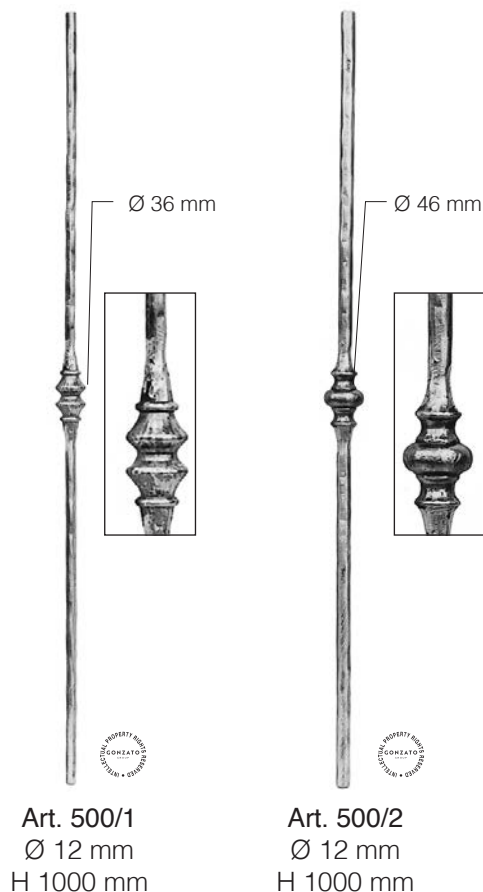
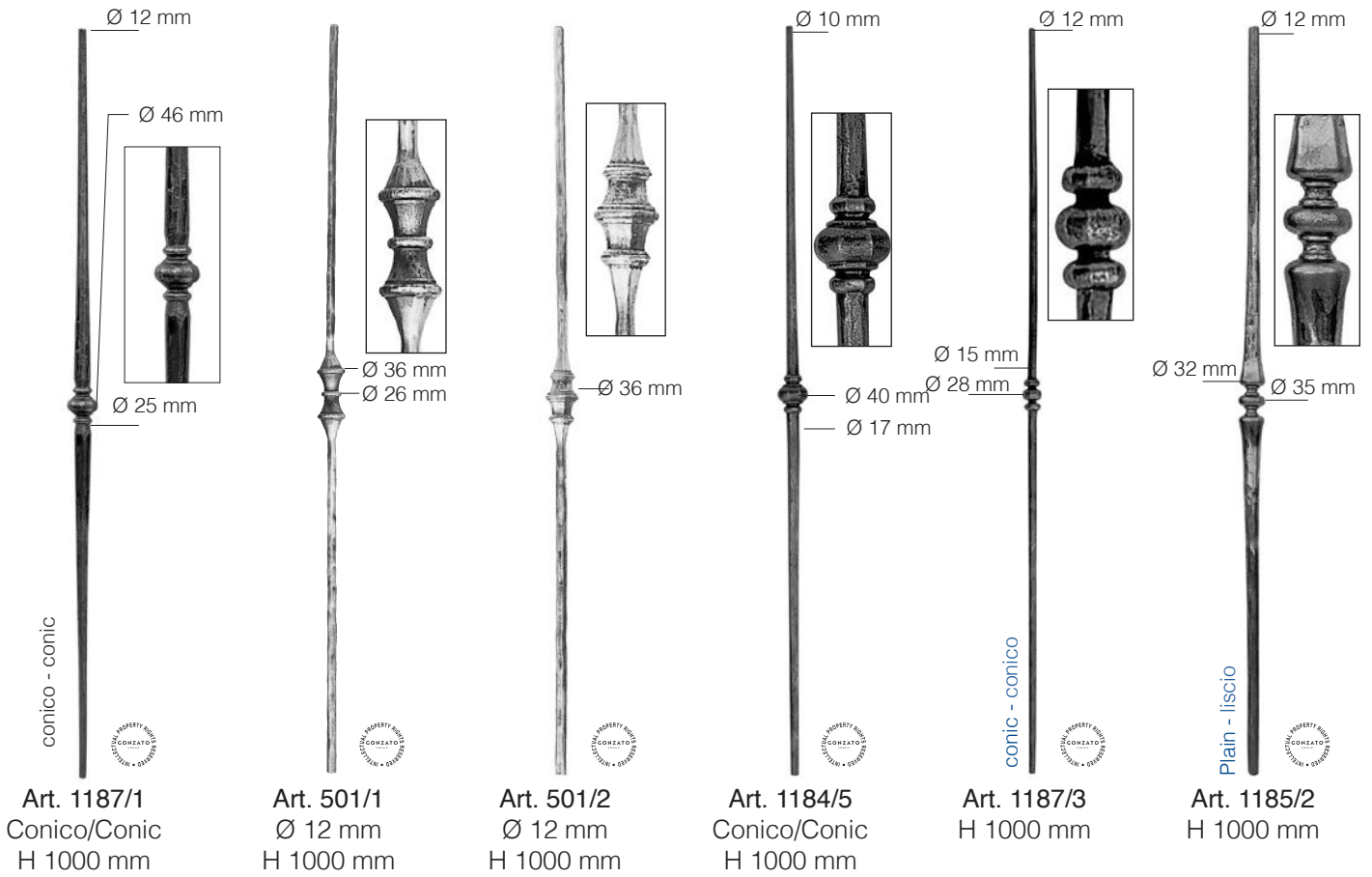



Art. 1198/2
Ø 30 mm
H 500 mm
Threaded hole
Foro filettato
Ø 12 MA



Art. 1198/1
Ø 30 x 30 mm
H 500 mm
Threaded hole
Foro filettato
Ø 12 MA



Art. 1198/5
Ø 12 mm
H 450 mm
Threaded hole
Foro filettato
Ø 8 MA



Art. 1198/6
Ø 12 x 12 mm
H 450 mm
Threaded hole
Foro filettato
Ø 8 MA

USE THE BUSH YOU
PREFER!
see pag.329

USA
LA BORCHIA
CHE VUOI!
vedi pag.329

example
esempio

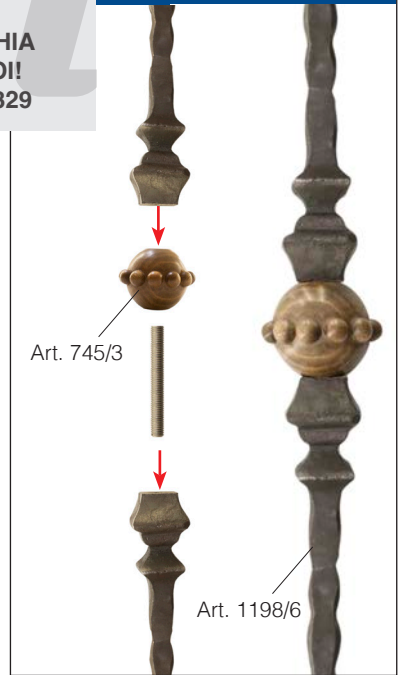

Art. 745/3

Art. 1198/6



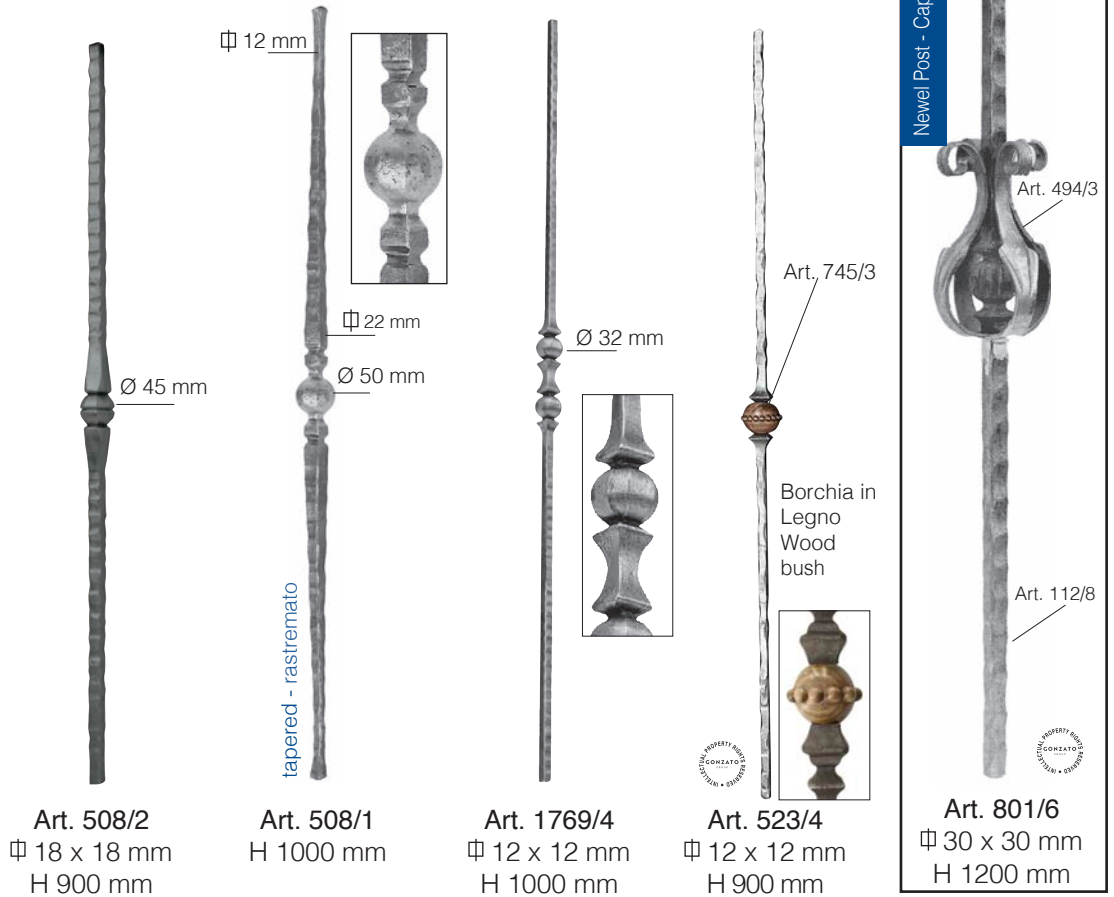
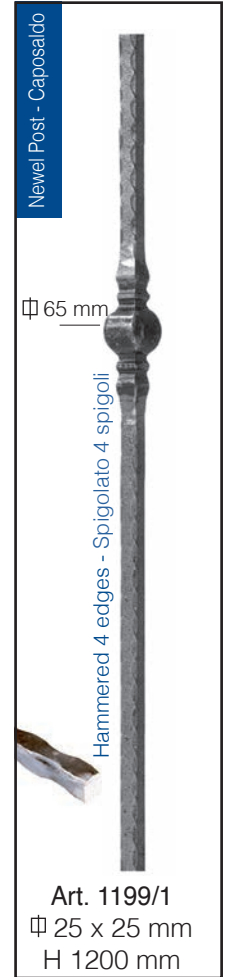
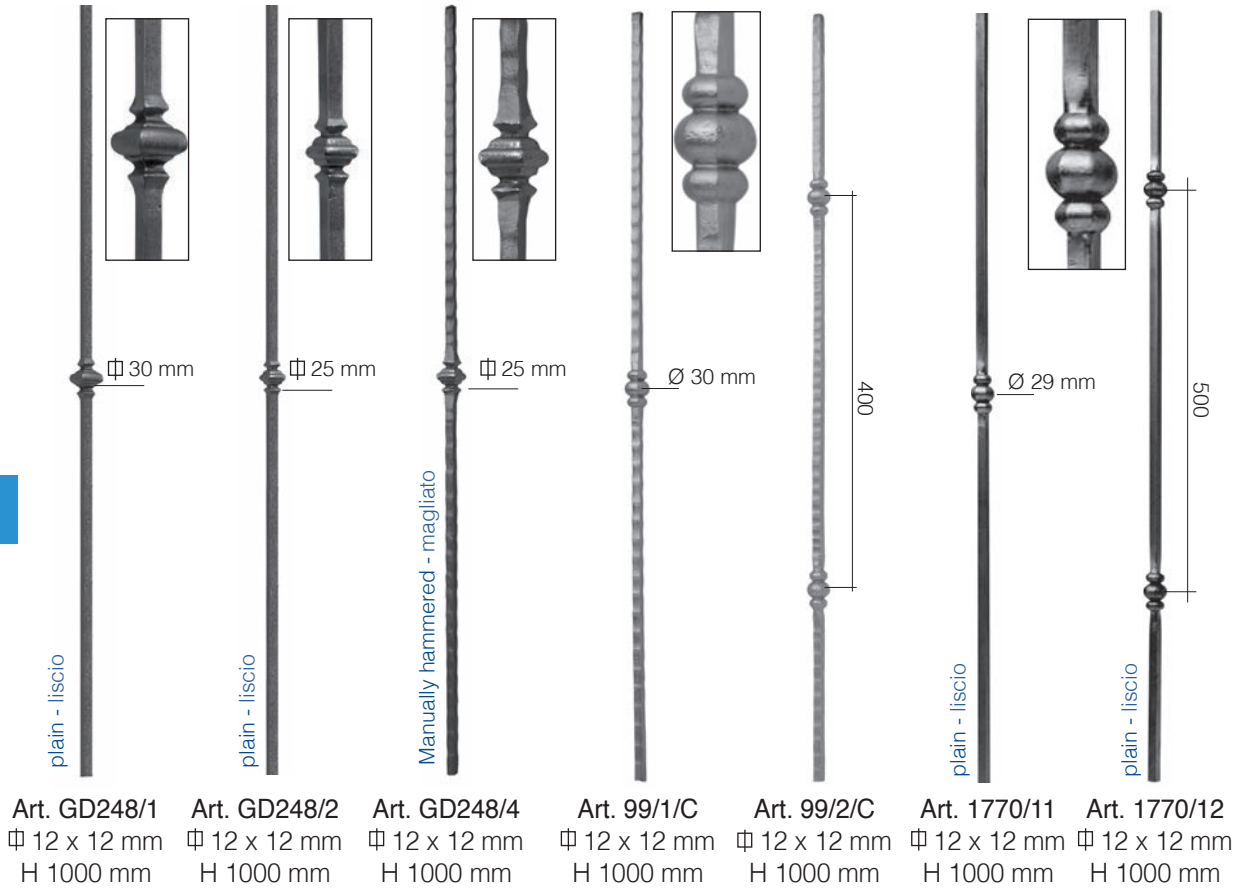

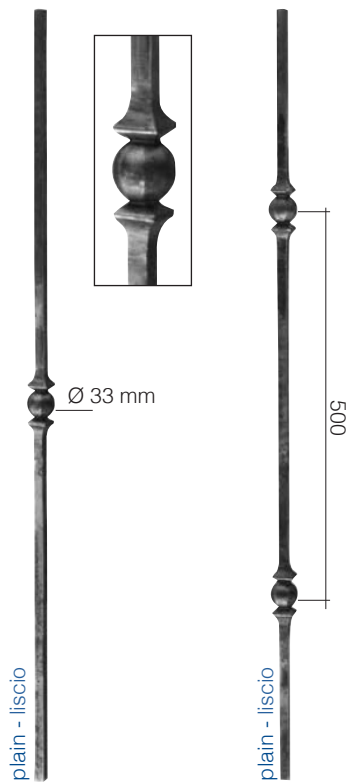

Art. 1770/15
 \varnothing 12 x 12 mm
 H 1000 mm
 Art. 1770/16
 \varnothing 14 x 14 mm
 H 1000 mm

Art. 1770/13
 \varnothing 12 x 12 mm
 H 1000 mm
 Art. 1770/14
 \varnothing 14 x 14 mm
 H 1000 mm

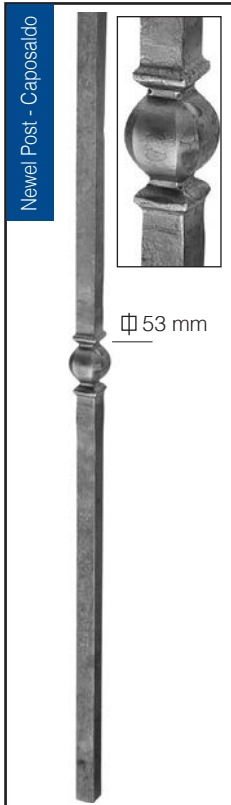

Art. 1769/7
 \varnothing 25 x 25 mm
 H 1200 mm
 Art. 1769/8
 \varnothing 30 x 30 mm
 H 1200 mm

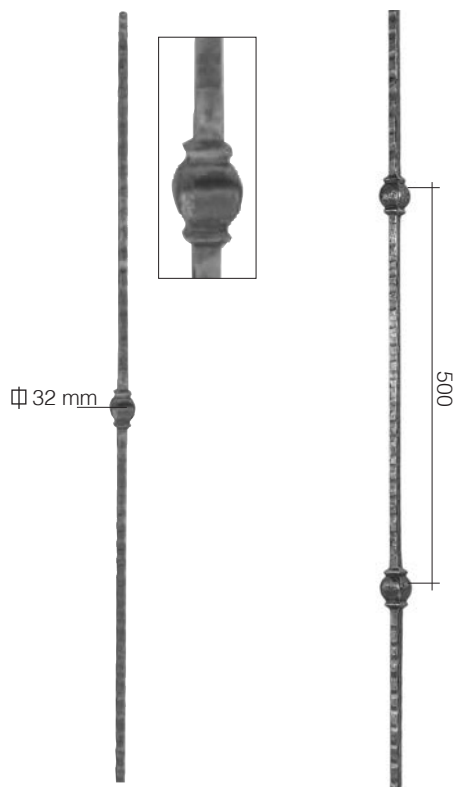

Art. 1770/8
 \varnothing 12 x 12 mm
 H 1000 mm

Art. 1771/8
 \varnothing 12 x 12 mm
 H 1000 mm

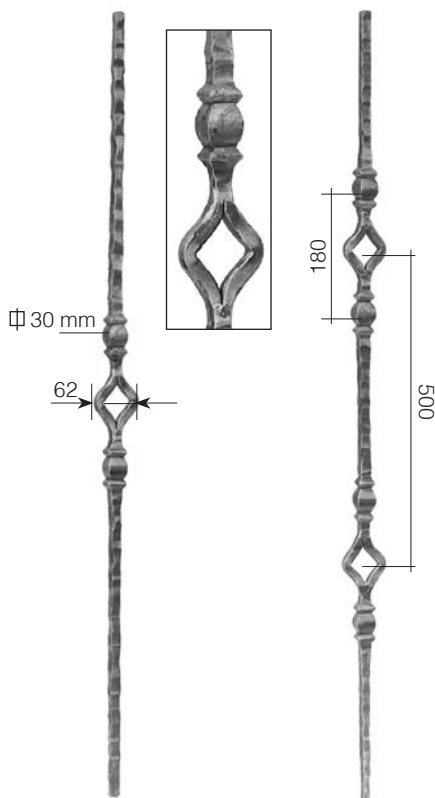

Art. 507/1
 \varnothing 14 x 14 mm
 H 1000 mm

Art. 507/2
 \varnothing 14 x 14 mm
 H 1000 mm

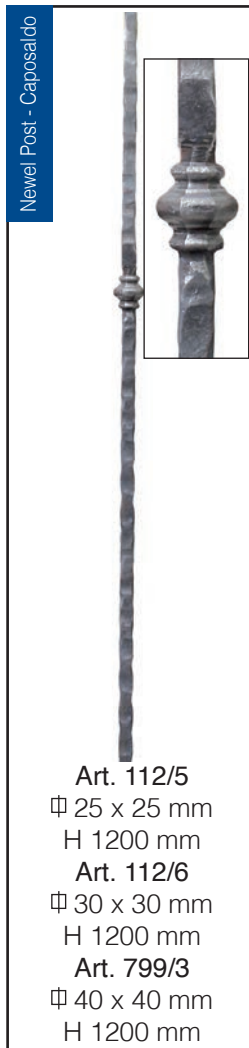

Art. 112/5
 \varnothing 25 x 25 mm
 H 1200 mm
 Art. 112/6
 \varnothing 30 x 30 mm
 H 1200 mm
 Art. 799/3
 \varnothing 40 x 40 mm
 H 1200 mm



Art. 98/1
H 1000 mm



Art. 493/2
H 1000 mm

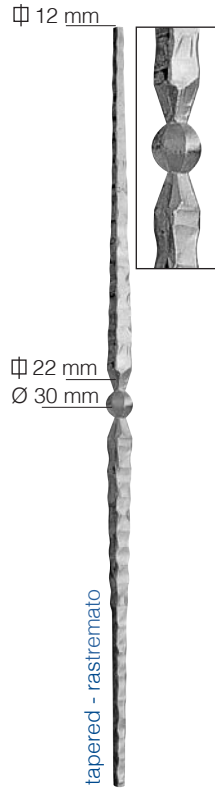

Art. 109/3
H 1000 mm



Art. 493/1
H 1000 mm



Art. 800/1
Ø 30 x 30 mm
H 1200 mm



Manually
hammered
square bar to
match with posts

Quadro magliato
manualmente
per abbinamento
caposaldi

Art. 1370/11
Ø 25 x 25 mm
L 2000 mm

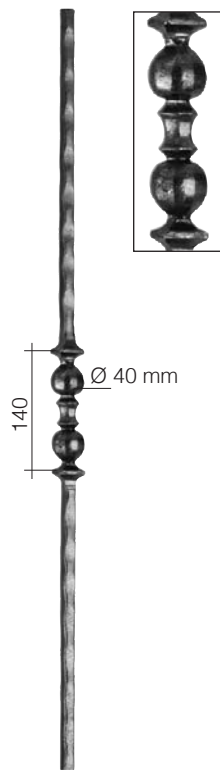

Art. 1770/5
Ø 14 x 14 mm
H 1000 mm

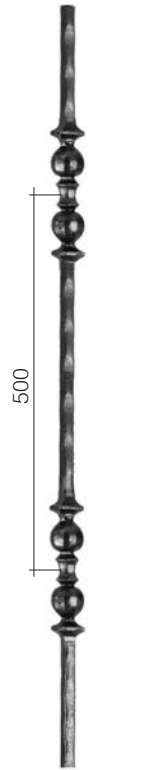

Art. 1771/5
Ø 14 x 14 mm
H 1000 mm

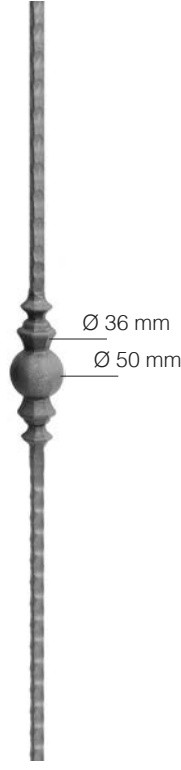

Art. 502/1
Ø 14 x 14 mm
H 1000 mm

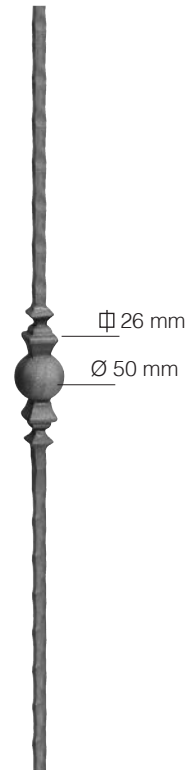

Art. 502/2
Ø 14 x 14 mm
H 900 mm



Art. 112/11
Ø 25 x 25 mm
H 1200 mm

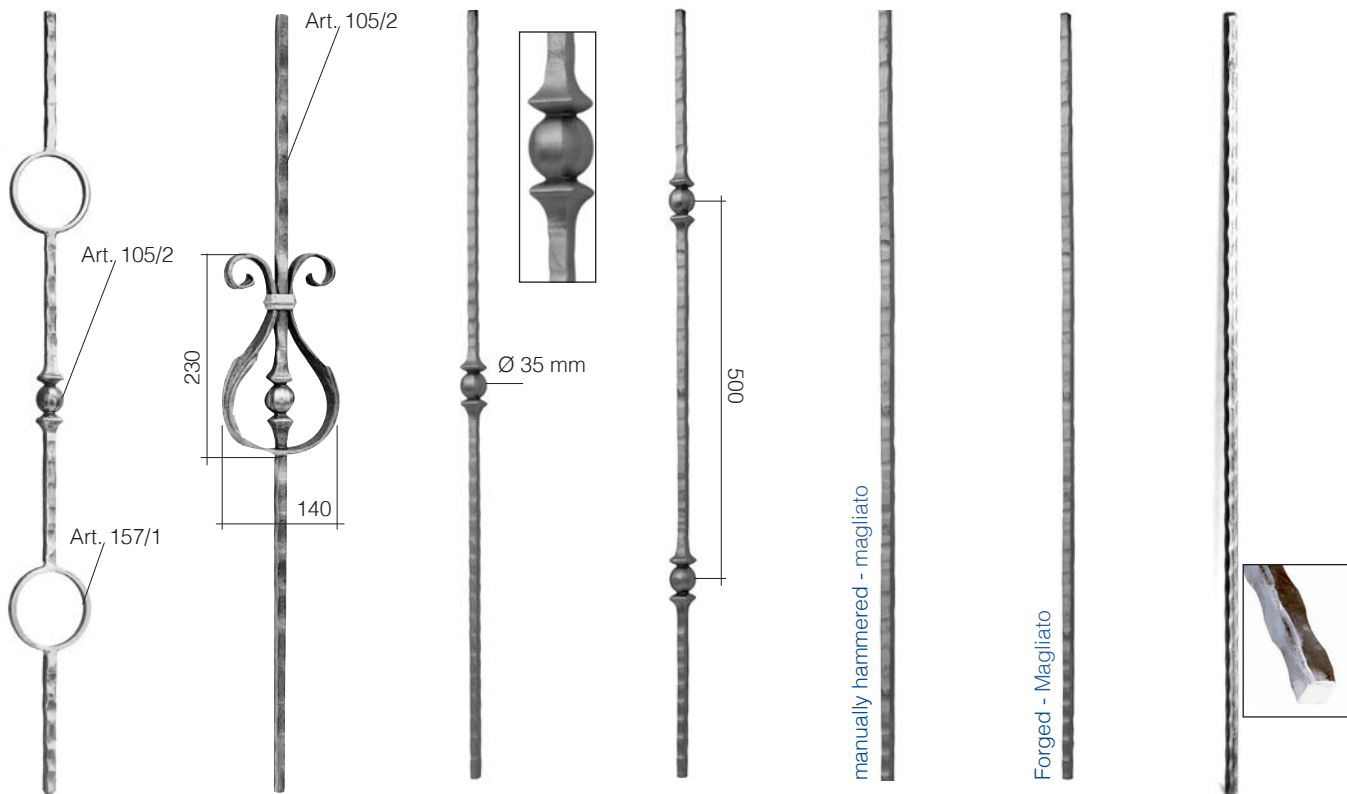

Art. 512/2
∅ 12 x 12 mm
100 x 1000 mm

Art. 494/1
∅ 12 x 12 mm
140 x 1000 mm

Art. 105/2/C
∅ 12 x 12 mm
H 1000 mm

Art. 105/1/C
∅ 12 x 12 mm
H 1000 mm

Art. 105/5/C
∅ 12 x 12 mm
H 1000 mm

Art. 105/5
H 1000 mm
∅ 12 x 12 mm

Art. 118/B/1
∅ 12 x 12 mm
H 900 mm

Art. 105/3
∅ 14 x 14 mm
H 1000 mm



Art. 1185/1
∅ 12 x 12 mm
H 1000 mm



Art. 1189/1
∅ 12 x 12 mm
H 900 mm

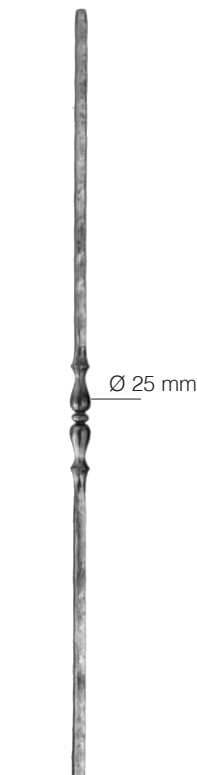

Art. 1770/6
∅ 12 x 12 mm
H 1000 mm



Art. 112/10
∅ 30 x 30 mm
H 1200 mm

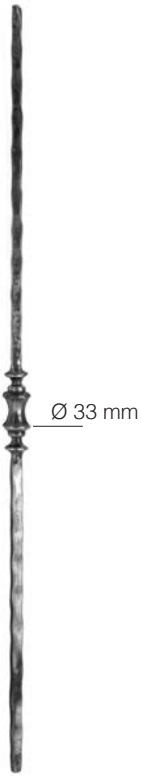

Art. 110/5
Ø 12 x 12 mm
H 1000 mm



Art. 110/4
Ø 14 x 14 mm
H 1000 mm

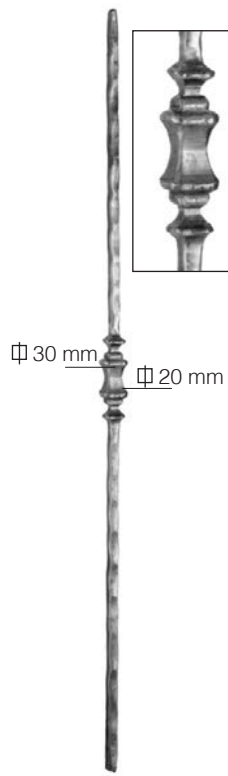

Art. 110/3
Ø 12 x 12 mm
H 1000 mm

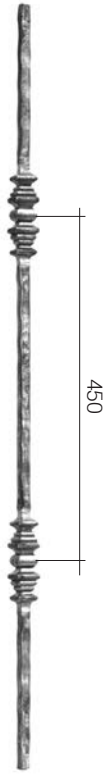

Art. 108/A/1
Ø 12 x 12 mm
H 1000 mm



Art. 108/A/2
Ø 12 x 12 mm
H 1000 mm

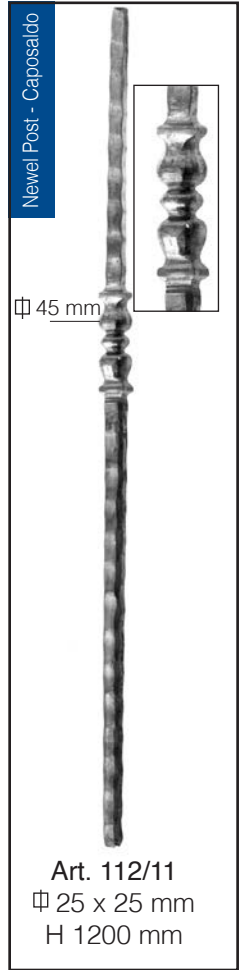

Art. 112/11
Ø 25 x 25 mm
H 1200 mm

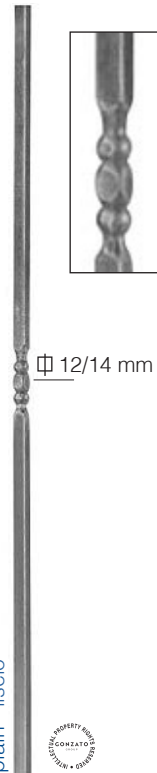

Art. 1773/6
Ø 12 x 12 mm
H 1000 mm

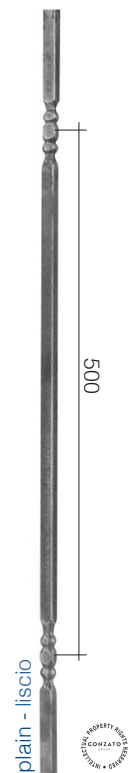

Art. 1773/5
Ø 12 x 12 mm
H 1000 mm

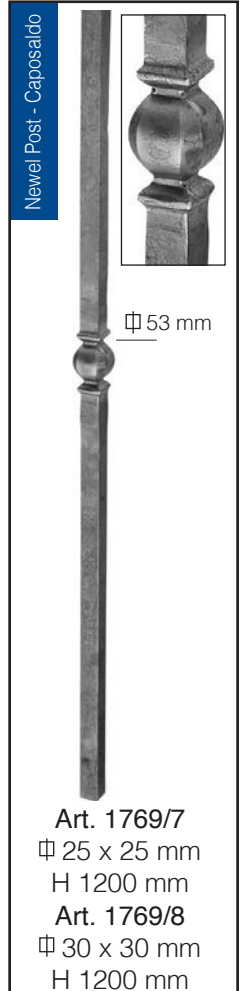

Art. 1769/7
Ø 25 x 25 mm
H 1200 mm
Art. 1769/8
Ø 30 x 30 mm
H 1200 mm

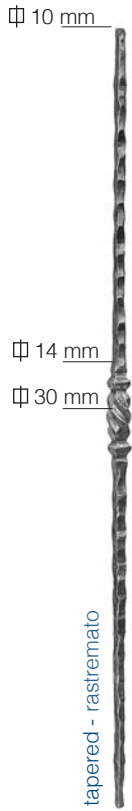

Art. 505/3
 \varnothing 14 x 14 mm
 H 1000 mm

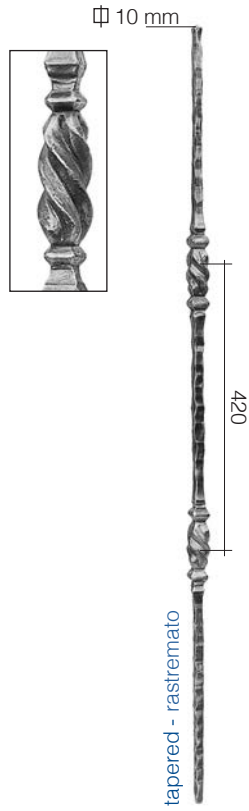

Art. 505/4
 \varnothing 14 x 14 mm
 H 1000 mm

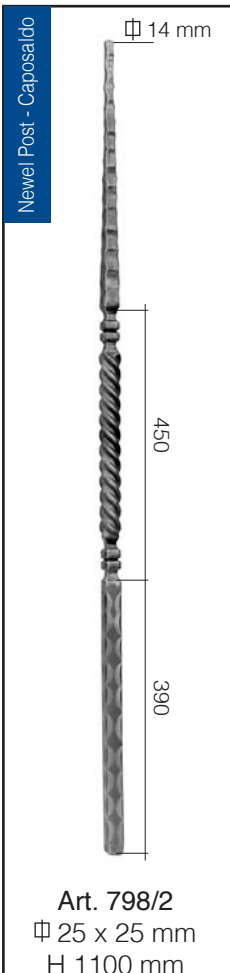
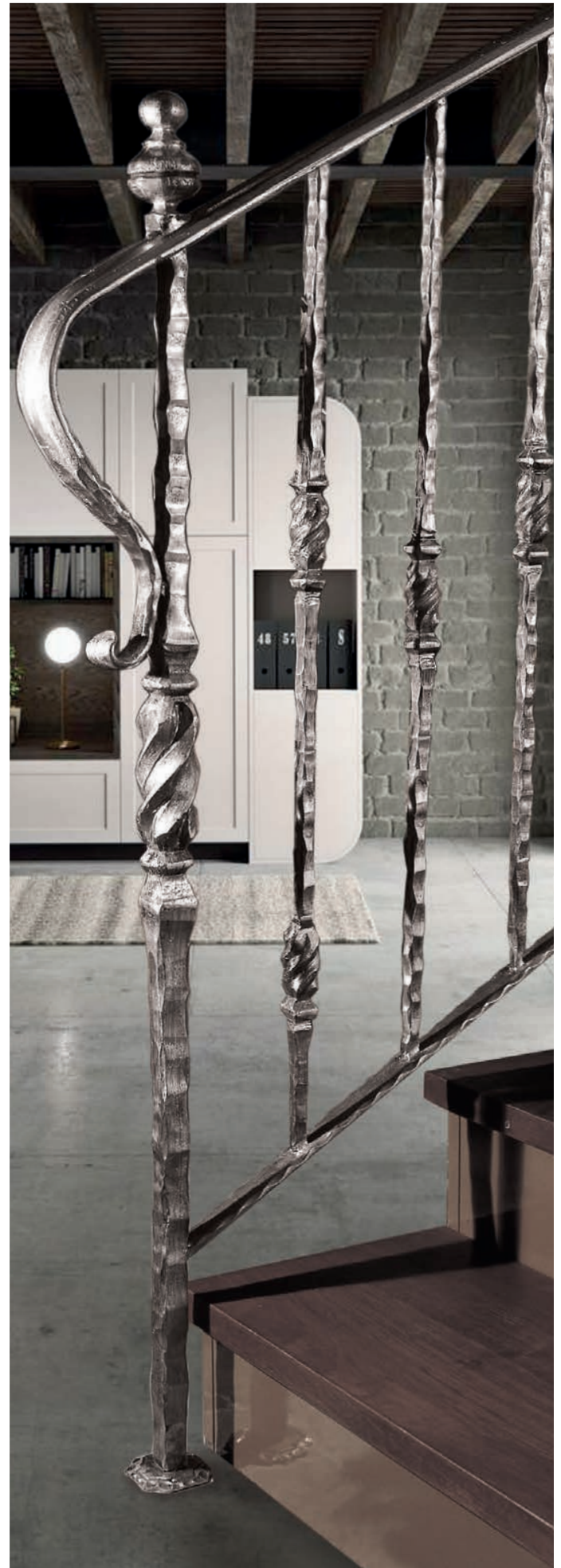

Art. 798/2
 \varnothing 25 x 25 mm
 H 1100 mm

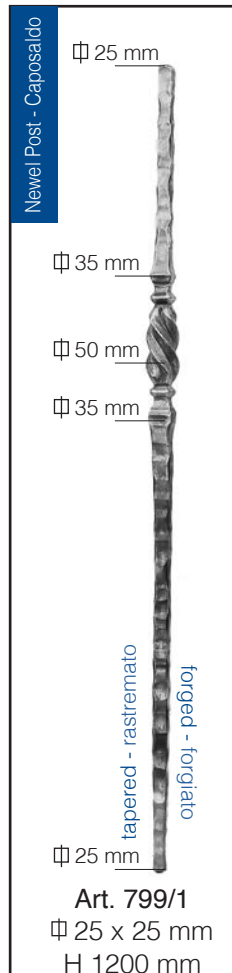

Art. 799/1
 \varnothing 25 x 25 mm
 H 1200 mm

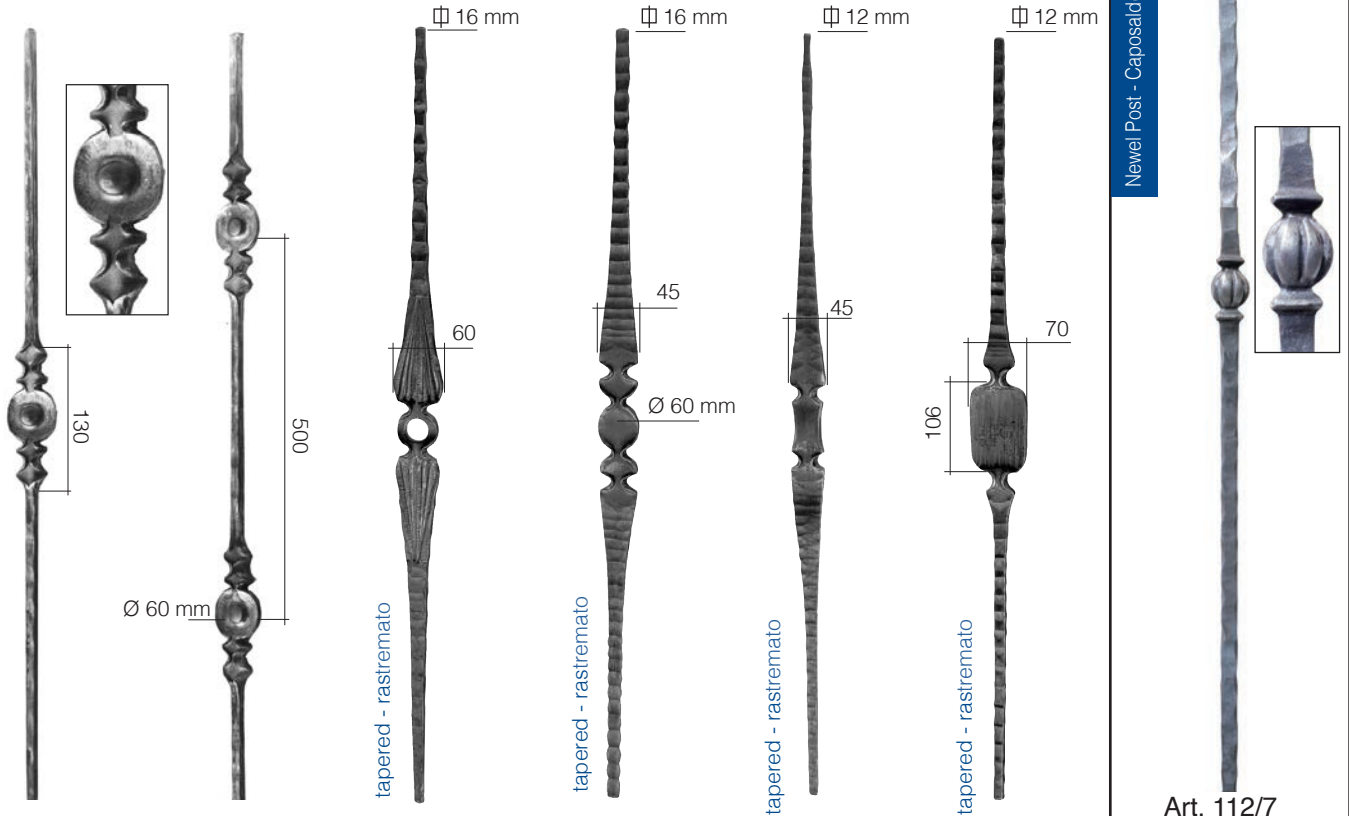

Art. 104/3
Ø 12 x 12 mm
H 1000 mm

Art. 104/4
Ø 12 x 12 mm
H 1000 mm

Art. 1192/1
Ø 16 x 8 mm
H 1000 mm

Art. 1192/2
Ø 16 x 8 mm
H 1000 mm

Art. 1192/3
Ø 12 x 10 mm
H 1000 mm

Art. 1192/4
Ø 12 x 10 mm
H 1000 mm

Art. 112/7
Ø 25 x 25 mm
H 1200 mm
Art. 112/8
Ø 30 x 30 mm
H 1200 mm

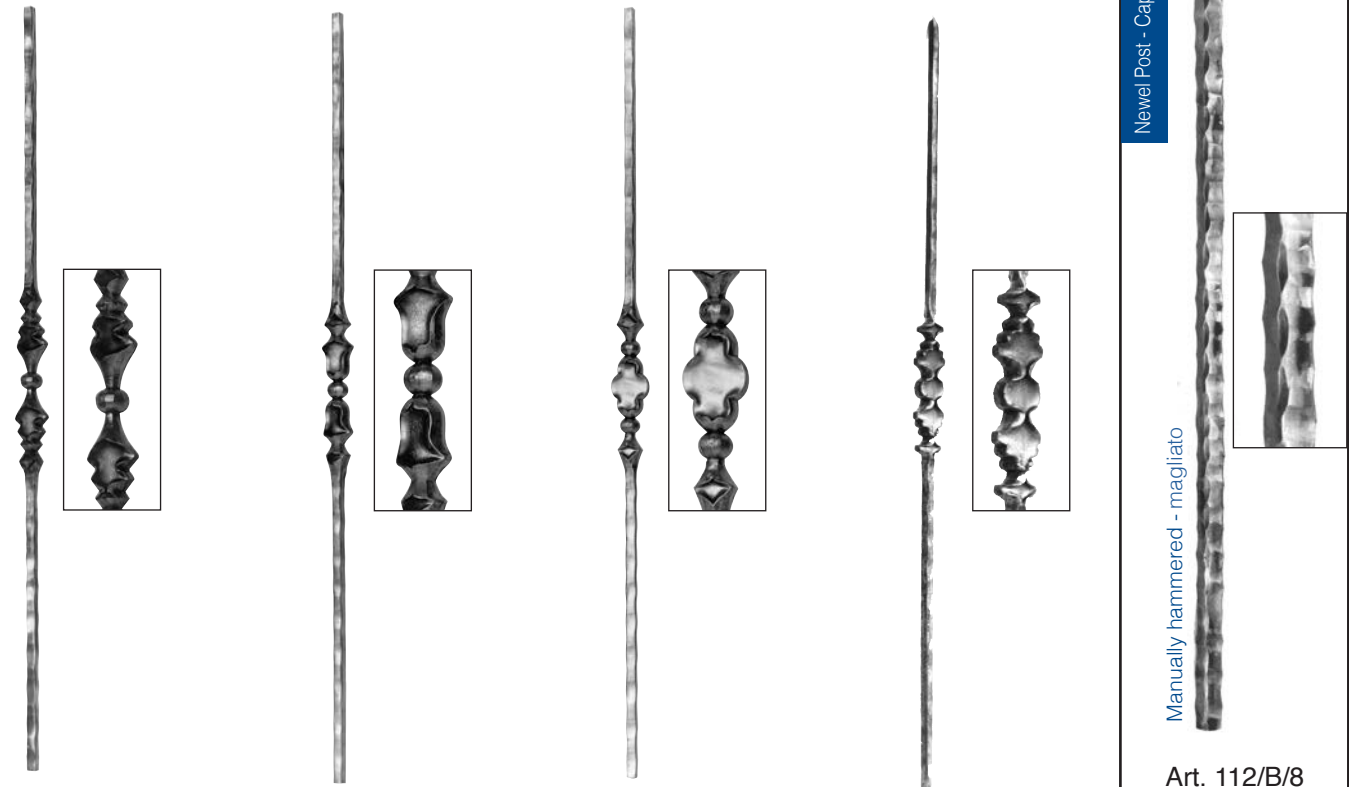

Art. 496/B/1
Ø 13 x 13 mm
H 1000 mm

Art. 496/B/2
Ø 13 x 13 mm
H 1000 mm

Art. 496/B/3
Ø 13 x 13 mm
H 1000 mm

Art. 106/2
Ø 12 x 12 mm
H 1000 mm

Art. 112/B/8
Ø 30 x 30 mm
H 1100 mm

matchable with forged pickets Ø 12 mm
abbinabili ai paletti forgiati Ø 12 mm



Art. 1185/4
Ø 12 mm
H 1000 mm

Forged - Magliato



Art. 1185/5
Ø 14 mm
H 1000 mm



Art. 1187/2
Conico/Conic
H 1000 mm

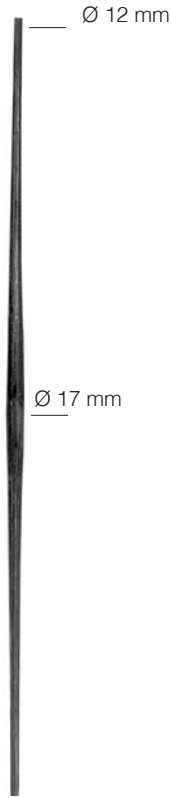

Art. 1184/6
Ø 12 mm
H 1000 mm

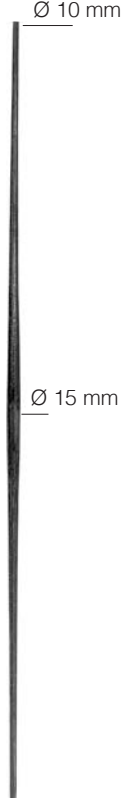

Art. 496/C/3/C
Conico/Conic
H 1000 mm



Art. 1256/5
Ø 25 mm
H 900 mm



Art. 1199/3
Ø 26 mm
H 1200 mm



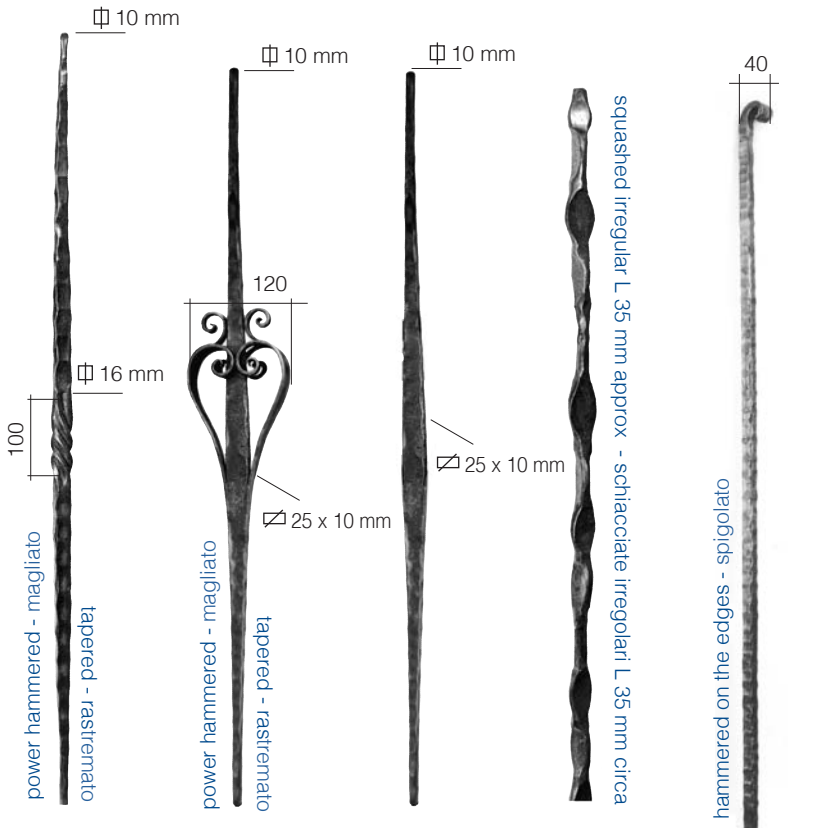

Art. 96/1 \varnothing 16 mm H 1000 mm
Art. 96/3 H 900 mm
Art. 96/3/S H 900 mm
Art. 96/4 \varnothing 18 mm H 830 mm
Art. 595/18 \varnothing 12 x 12 mm H 900 mm

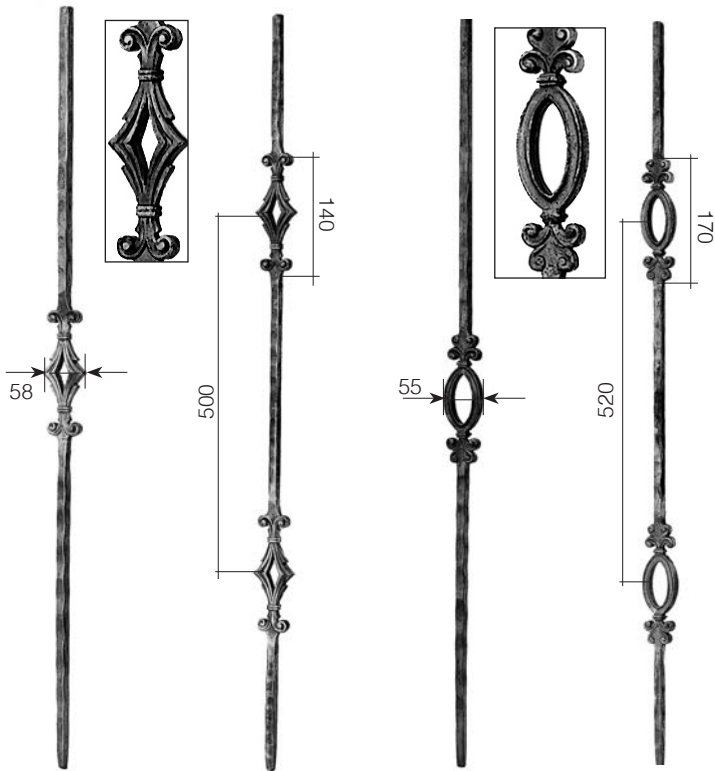
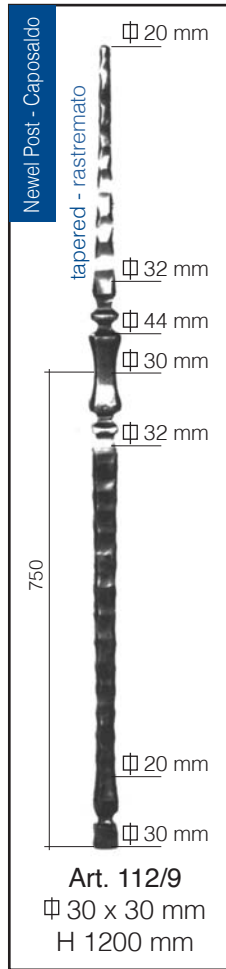







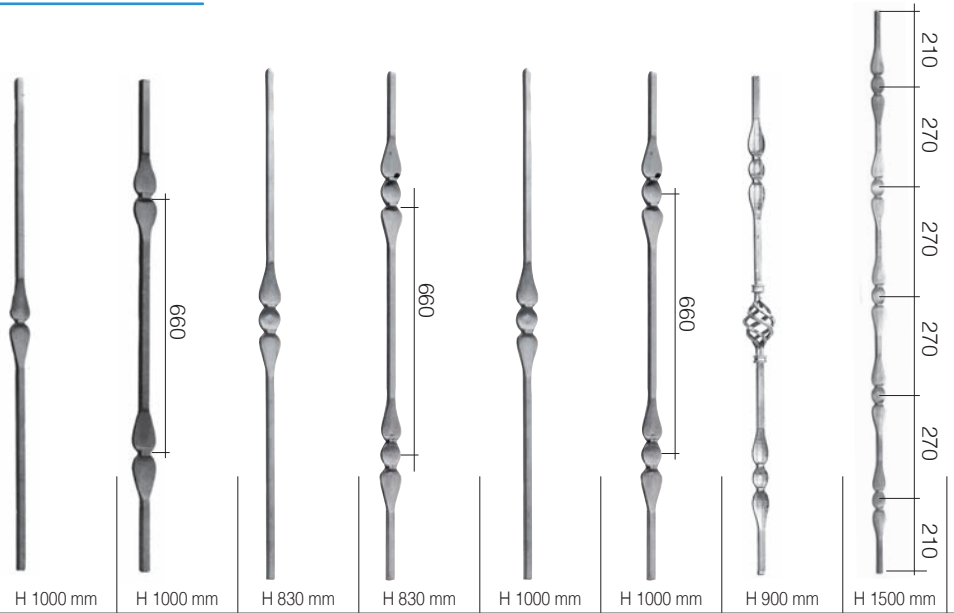



Art. 489/2 \varnothing 14 x 14 mm H 1000 mm
Art. 489/1 \varnothing 14 x 14 mm H 1000 mm
Art. 490/2 \varnothing 14 x 14 mm H 1000 mm
Art. 490/1 \varnothing 14 x 14 mm H 1000 mm















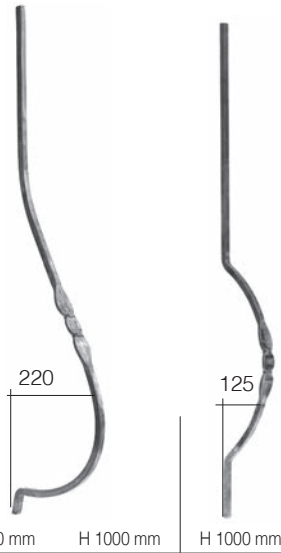
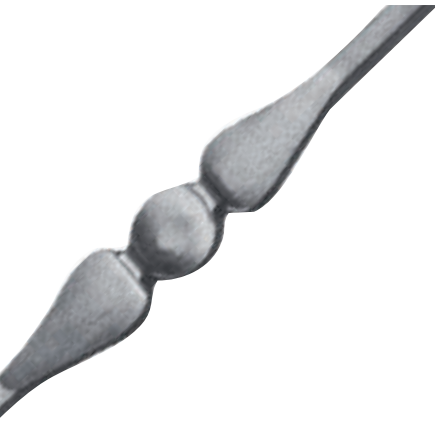

Sec.Sez.	Finish - Finitura	Art	Art	Art.	Art.	Art.	Art.	Art.	Art.
Ø 12 mm	Plain - Liscio 	134/6	134/14	134/1	-	134/2	134/10	585/1	-
	Stamped on plain edge Stampato sullo spigolo liscio 	-	-	-	-	1749/11	1749/9	-	-
	Hammered - Spigolato 	-	-	587/41	587/45	587/42	587/46	-	-
∇ 12 x 6 mm	Plain - Liscio 	-	-	-	-	-	-	-	134/A/12
Ø 12 mm	Plain - Liscio 	-	-	-	-	1251/9	1251/10	-	-
Ø 14 mm	Plain - Liscio 	-	-	-	-	134/4	134/12	-	-
	Stamped on plain edge Stampato sullo spigolo liscio 	-	-	-	-	-	-	-	-
	Hammered - Spigolato 	-	-	-	-	587/44	587/48	-	-
	Bark effect - Corteccia 	-	-	-	-	1251/3	1251/4	-	-
Ø 14 mm	Four-leaf clover - Quadrifoglio 	-	-	-	-	1251/7	1251/8	-	-
	Plain - Liscio 	-	-	-	-	1251/11	1251/12	-	-

Arteferro products can be manufactured as well as customised.

I prodotti Arteferro sono realizzabili anche su misura.

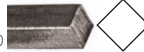

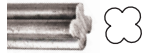



Sec.Sez.	Finish - Finitura	Art.	Art.	Art.
∅ 12 mm	Plain - Liscio 	586/14	586/6	586/8
	Stamped on plain edge Stampato sullo spigolo liscio 	-	-	-
	Hammered - Spigolato 	-	-	-
∩ 12 x 6 mm	Plain - Liscio 	-	-	-
∅ 12 mm	Plain - Liscio 	-	586/12	586/10
∅ 14 mm	Plain - Liscio 	586/15	586/7	586/9
	Stamped on plain edge Stampato sullo spigolo liscio 	-	-	-
	Hammered - Spigolato 	-	-	-
	Bark effect - Corteccia 	-	-	-
∅ 14 mm	Four-leaf clover - Quadrifoglio 	-	-	-
	Plain - Liscio 	-	586/13	586/11

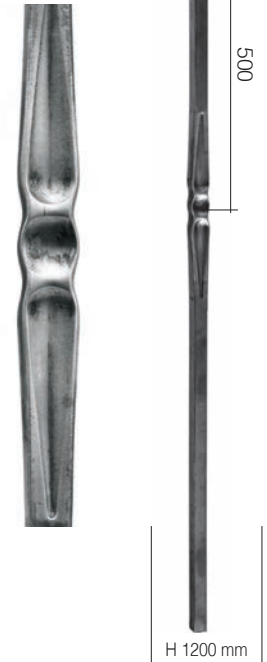

Newel Post - Caposaldo

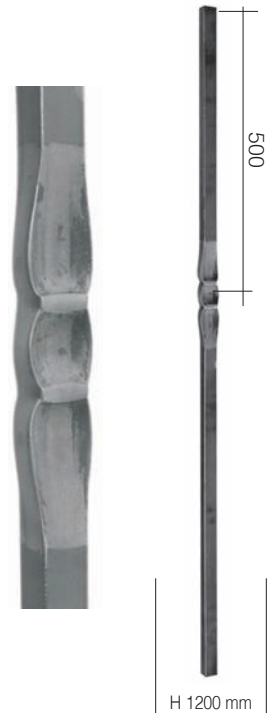

Sec.Sez.	Finish - Finitura	Art.
∅ 25 mm	Plain Liscio 	1775/11
∅ 25 mm	Plain Liscio 	1775/6
∅ 30 mm	Plain Liscio 	1775/12

Newel Post - Caposaldo

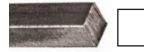

Sec.Sez.	Finish - Finitura	Art.
∅ 25 mm	Plain Liscio 	1775/4
∅ 25 mm	Plain Liscio 	1775/1
∅ 30 mm	Plain Liscio 	-



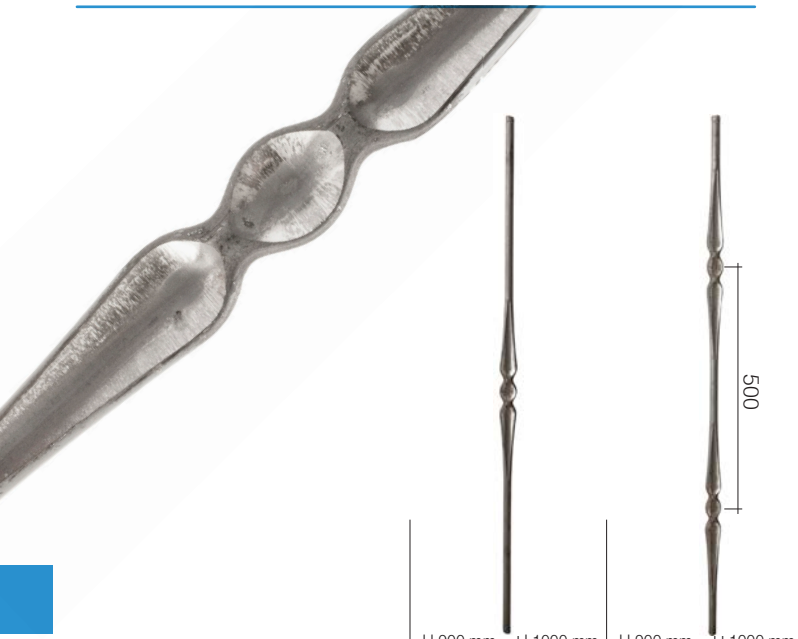

Sec.Sez.	Finish - Finitura	Art.	Art.	Art.	Art.
∅ 12 mm	Plain Liscio	-	1749/1	-	1749/3
∅ 14 mm	Plain Liscio	-	1749/2	-	1749/4
∅ 14 mm	Hammered Spigolato	-	-	64/L/1	-
∅ 14 mm	Plain Liscio	64/L/4	-	64/L/3	-



Sec.Sez.	Finish - Finitura	Art.	Art.	Art.
∅ 12 mm	Plain Liscio	1721/1	1721/3	-
∅ 14 mm	Plain Liscio	-	-	1721/6



Newel Post - Caposaldo

Sec.Sez.	Finish - Finitura	Art.
∅ 20 mm	Plain Liscio	1775/3
∅ 25 mm	Plain Liscio	1775/4

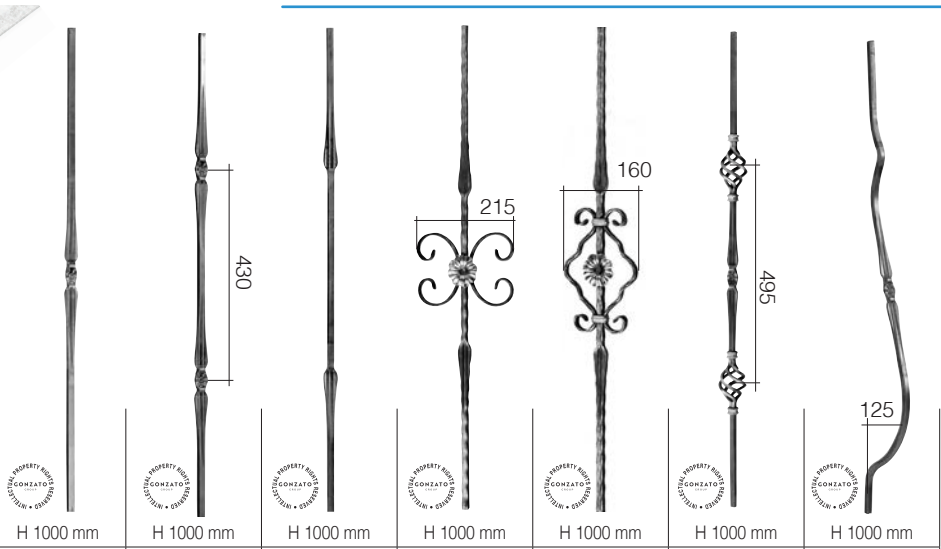

Sec.Sez.	Finish - Finitura	Art.	Art.	Art.	Art.	Art.	Art.	Art.
∅ 12 mm	Plain Liscio	1705/1	1705/3	1705/5	-	-	1733/3	1705/13
	Hammered Spigolato	1707/1	1707/3	1707/5	-	-	-	1780/1
	Bark effect Cortecchia	1710/1	1710/2	1710/5	-	-	-	-
∅ 12 mm	Plain Liscio	1716/1	1716/3	-	-	-	-	-
∅ 14 mm	Plain Liscio	1705/2	1705/4	-	-	-	-	-
	Hammered Spigolato	-	1707/4	-	-	-	-	-
	Bark effect Cortecchia	-	1710/4	1710/6	1710/8	-	-	-
∅ 14 mm	Plain Liscio	1716/2	1716/4	-	-	1716/10	-	-



Newel Post - Caposaldo

H 1200 mm

Sec.Sez.	Finish - Finitura	Art.
∅ 25 mm	Plain Liscio	1705/15
	Bark effect Cortecchia	1777/4

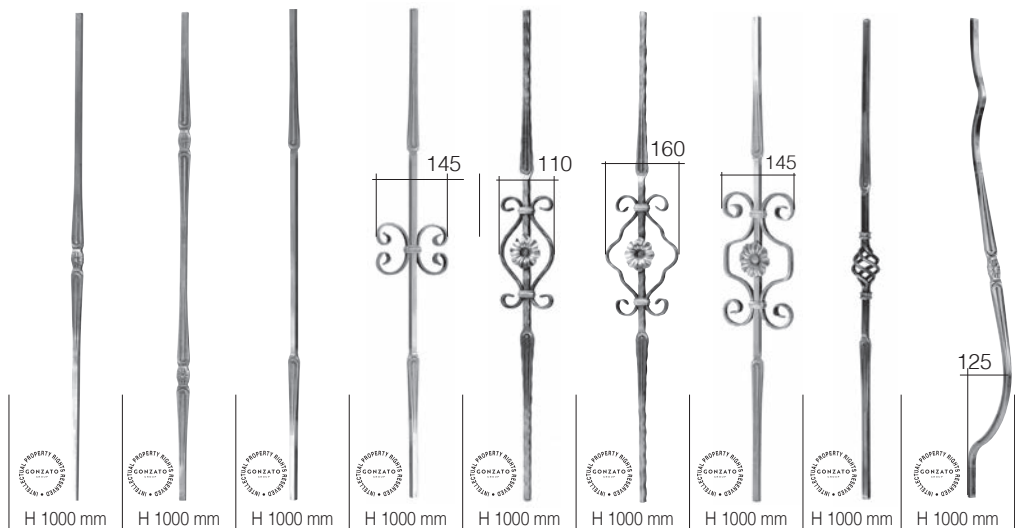

Sec.Sez.	Finish - Finitura		Art.	Art.	Art.	Art.	Art.	Art.	Art.	Art.	Art.
∅ 12 mm	Plain Liscio		1701/1	1701/3	1701/5	1701/7	-	-	1701/11	1733/9	1701/13
	Hammered Spigolato		1709/1	1709/3	1709/5	-	1709/9	1709/11	-	-	1780/5
	Bark effect Cortecchia		1710/13	1710/5	-	-	1710/21	1710/23	-	-	1780/13
∅ 12 mm	Plain Liscio		1716/13	1716/15	-	-	-	1716/21	-	-	-
∅ 14 mm	Plain Liscio		1701/2	1701/4	1701/6	-	-	-	1701/12	1733/10	1701/14
	Hammered Spigolato		1709/2	1709/4	1709/6	-	1709/10	1709/12	-	-	1780/6
	Bark effect Cortecchia		-	1710/16	1710/18	-	1710/22	1710/24			1780/14
∅ 14 mm	Plain Liscio		1716/14	1716/16	1716/18	-	-	1716/22			1779/14



Newel Post - Caposaldo

H 1200 mm

Sec.Sez.	Finish - Finitura		Art.
∅ 25 mm	Plain Liscio		1701/15
	Hammered Spigolato		1777/7



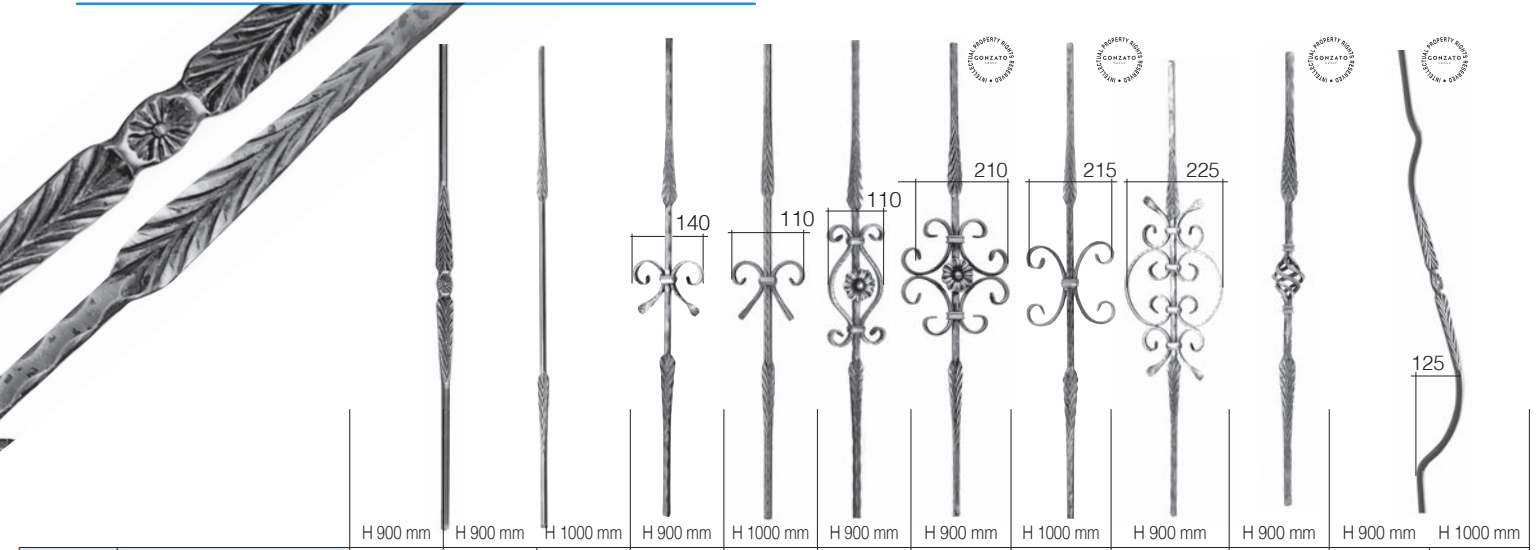

Sec.Sez.	Finish - Finitura	Art.	Art.	Art.	Art.	Art.	Art.	Art.	Art.	Art.	Art.	Art.	Art.
Ø 12 mm	Plain Liscio	-	-	-	-	-	-	-	-	-	-	-	-
	Hammered Spigolato	64/F/2	64/F/4	-	64/F/6	-	64/F/8	561/5	561/3	64/G/1	562/1	64/H/9	64/H/9/S
	Diamond Diamantato	-	-	1137/3	-	1138/3	-	-	-	-	-	-	1137/7
Ø 14 mm	Plain Liscio	-	-	-	-	-	-	-	-	-	-	572/1	-
	Hammered Spigolato	64/F/3	64/F/5	-	64/F/7	-	64/F/9	561/6	561/4	64/G/2	562/2	64/H/10	64/H/10/S
	Diamond Diamantato	-	-	-	-	1138/4	-	-	-	-	-	-	1137/8
Ø 14 mm	Plain Liscio	573/2	573/4	573/10	-	-	-	-	-	-	-	572/3	-

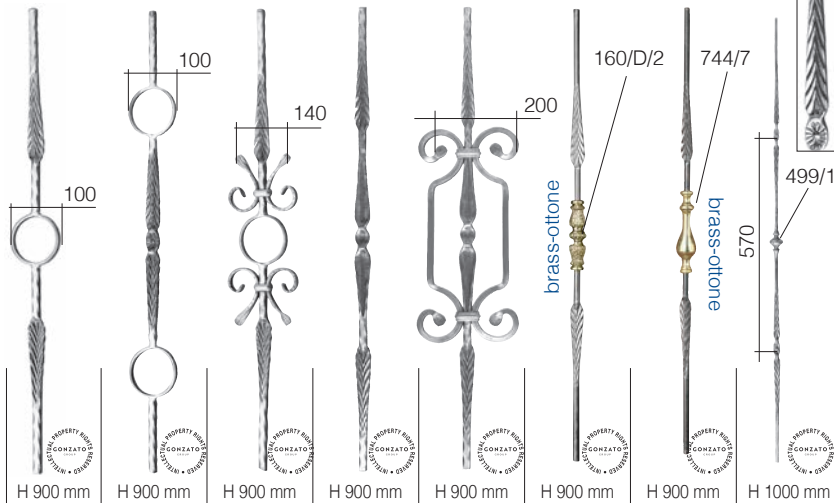

Sec.Sez.	Finish - Finitura	Art.	Art.	Art.	Art.	Art.	Art.	Art.	Art.
Ø 12 mm	Hammered Spigolato	-	563/1	-	571/1	-	-	-	-
Ø 14 mm	Hammered Spigolato	563/4	563/2	567/2	571/2	571/4	-	-	-
Ø 12 mm	Power hamm Magliato	-	-	-	-	-	-	-	504/1
Ø 14 mm	Plain Liscio	-	-	-	-	-	560/1	560/2	-

Newel Post - Caposaldo



hammered - spigolato

Art. 64/F/1
Ø 25 x 25 mm
H 1200 mm

Newel Post - Caposaldo



plain - liscio

Art. 801/1
Ø 25 mm
H 1200 mm

Art. 801/7
Ø 30 mm
H 1200 mm

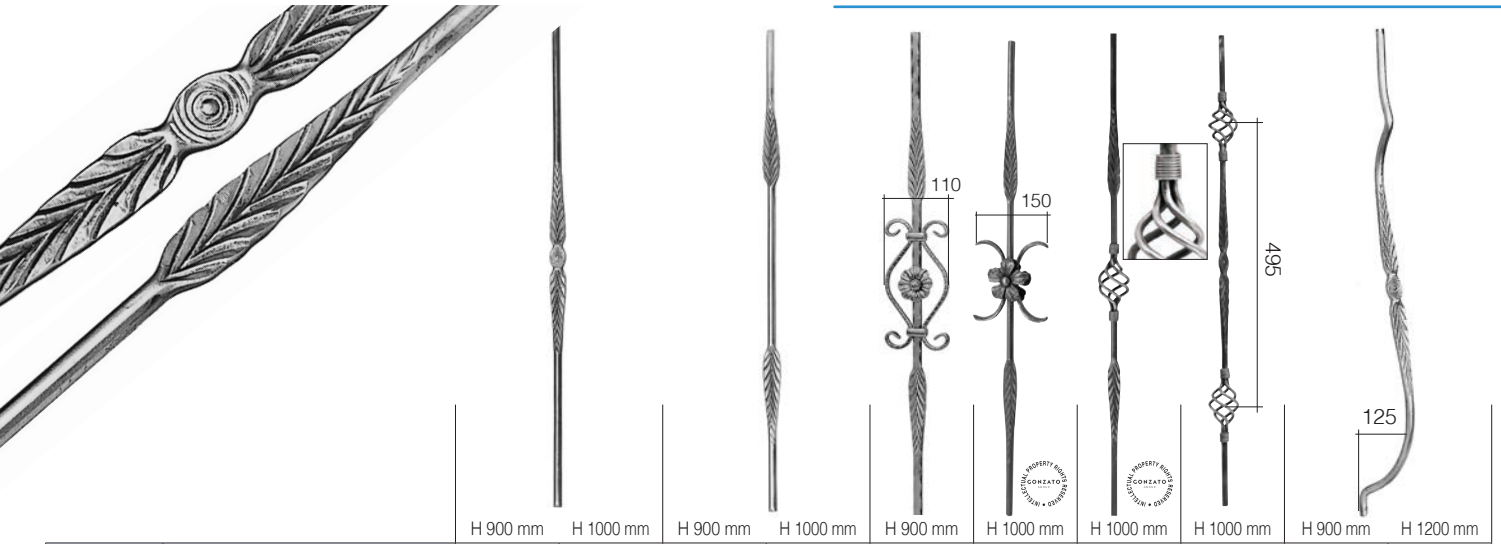

Sec.Sez.	Finish - Finitura	Art.	Art.	Art.	Art.	Art.	Art.	Art.	Art.	Art.	Art.
Φ 12 mm	Plain Liscio	-	-	-	-	-	-	-	-	-	-
	Hammered Spigolato	578/1	1136/5	578/3	1136/6	578/5	-	-	-	578/17	578/18
	Diamond Diamantato	-	-	-	-	-	-	-	-	-	-
Ø 12 mm	Plain Liscio	576/1	576/5	576/3	576/6	-	-	1734/1	1734/2	578/13	578/14
Φ 14 mm	Plain Liscio	-	-	-	-	-	-	-	-	-	-
	Hammered Spigolato	578/2	1136/9	578/4	1136/10	578/6	-	-	-	578/19	578/20
	Diamond Diamantato	-	-	-	-	-	-	-	-	-	-
Ø 14 mm	Plain Liscio	576/2	1135/3	576/4	1135/4	-	1135/2	-	-	578/15	578/16

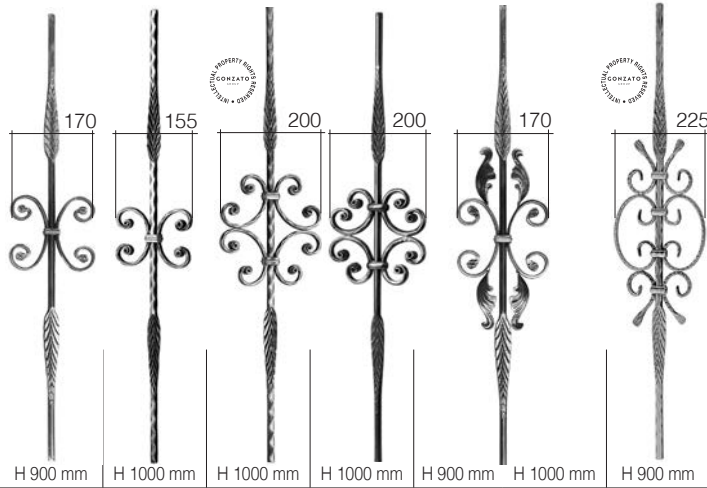

Sec.Sez.	Finish - Finitura	Art.	Art.	Art.	Art.	Art.	Art.	Art.
Φ 12 mm	Plain Liscio	-	-	-	-	-	-	-
	Hammered Spigolato	-	-	1136/4	-	-	-	578/9
	Diamond Diamantato	-	-	1138/7	-	-	-	-
Ø 12 mm	Plain Liscio	-	1136/3	-	-	577/9	577/10	-
Φ 14 mm	Plain Liscio	-	-	-	-	-	-	-
	Hammered Spigolato	-	-	1136/8	-	-	-	578/10
	Diamond Diamantato	-	-	1138/8	-	-	-	-
Ø 14 mm	Plain Liscio	577/3	1136/7	-	1136/2	577/2	577/5	-

hammered - spigolato

Art. 801/2
Φ 25 x 25 mm
H 1200 mm







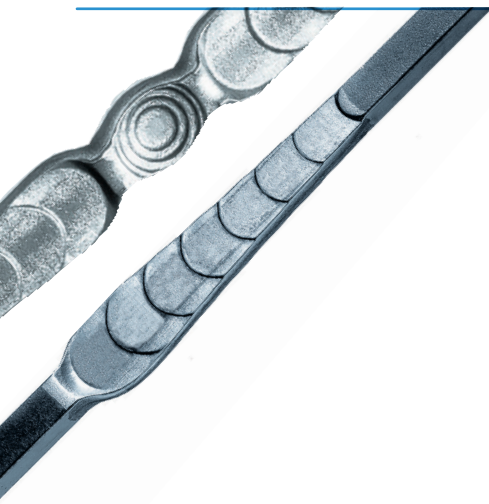

Newel Posti - Caposaldo

plain - liscio

Art. 801/5
Ø 25 mm
H 1200 mm

Art. 801/8
Ø 30 mm
H 1200 mm





Sezione	Finish - Finitura	Art.	Art.	Art.	Art.	Art.	Art.	Art.
Φ 12 mm	Plain Liscio 	1702/1	1702/3	1702/5	1702/7	-	1733/5	1702/13
	Hammered Spigolato 	1709/13	1709/15	-	-	1709/19	-	-
	Bark effect Cortecchia 	1713/1	-	1713/5	-	1713/7	-	1780/11
Ø 12 mm	Plain Liscio 	1714/1	1714/3	1714/5	-	-	-	1779/11
Φ 14 mm	Plain Liscio 	1702/2	1702/4	1702/6	1702/8	-	1733/6	1702/14
	Hammered Spigolato 	-	1709/16	-	-	1709/20	-	1780/4
	Bark effect Cortecchia 	1713/2	1713/4	1713/6	-	-	-	1780/12
Ø 14 mm	Plain Liscio 	1714/2	1714/4	1714/6	-	-	-	1779/12

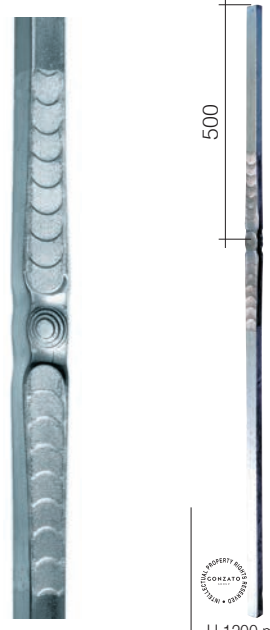

Newel Post - Caposaldo



Sezione	Finish - Finitura	Art.
Φ 25 mm	Plain Liscio 	1702/15
	Hammered Spigolato 	1777/8
Ø 25 mm	Plain Liscio 	1777/3

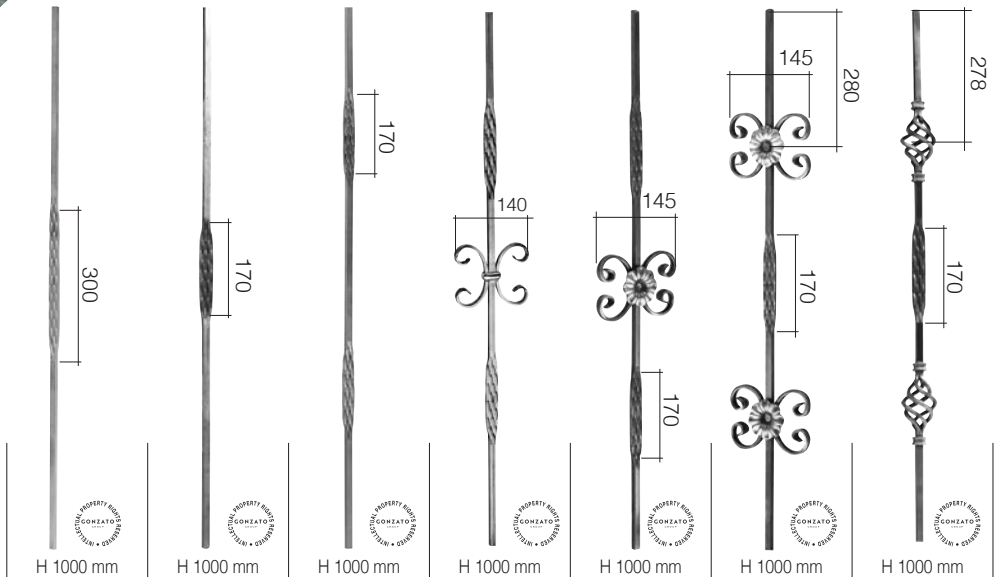
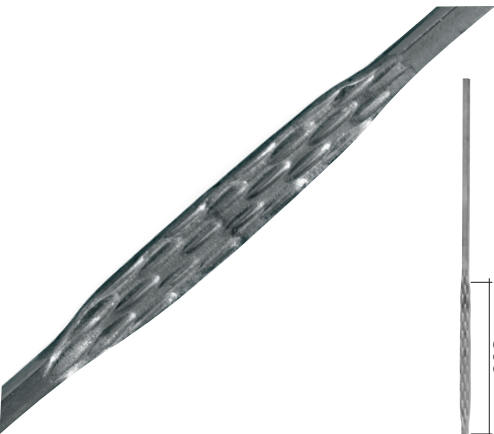

Sec.Sez.	Finish - Finitura	Art.	Art.	Art.	Art.	Art.	Art.	Art.
12 mm	Plain Liscio	1727/1	1729/11	1727/3	-	1729/7	1729/5	1729/1
Φ 14 mm	Plain Liscio	1727/2	1729/12	1727/4	1727/6	1729/8	1729/6	1729/2

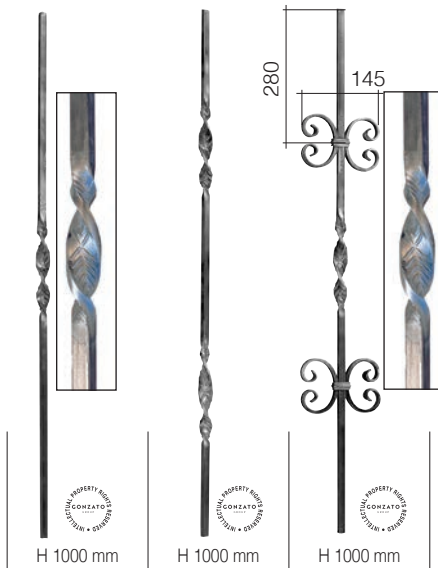

Sec.Sez.	Finish - Finitura	Art.	Art.	Art.
Φ 12 mm	Plain Liscio	1730/11	1730/9	1730/13
Φ 14 mm	Plain Liscio	1730/12	1730/10	-

Newel Post - Caposaldo

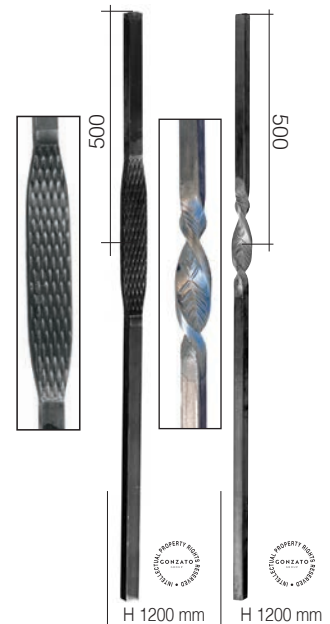

Sec.Sez.	Finish - Finitura	Art.	Art.
Φ 20 mm	Plain Liscio	1775/7	-
Φ 25 mm	Plain Liscio	1775/8	1730/17
Φ 30 mm	Plain Liscio	1777/9	-

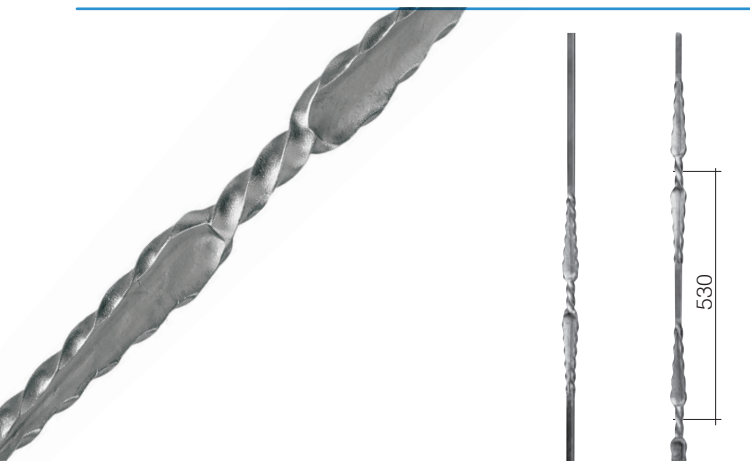

Sec.Sez.	Finish - Finitura	Art.	Art.
∅ 12 mm	Plain Liscio	1730/3	1730/1
∅ 14 mm	Plain Liscio	1730/4	1730/2

Sec.Sez.	Finish - Finitura	Art.	Art.
∅ 12 mm	Plain Liscio	1730/7	-
∅ 14 mm	Plain Liscio	1730/8	1730/6



Sec.Sez.	Finish - Finitura	Art.	Art.	Art.	Art.
∅ 12 mm	Plain Liscio	50/5	50/6	50/7	50/8
∅ 14 mm	Plain Liscio	50/9	50/10	50/11	50/12
∅ 16 mm	Plain Liscio	50/13	50/14	50/15	-



Sec.Sez.	Finish - Finitura	Art.
∅ 20 mm	Plain Liscio	113/5
∅ 30 mm	Plain Liscio	113/6

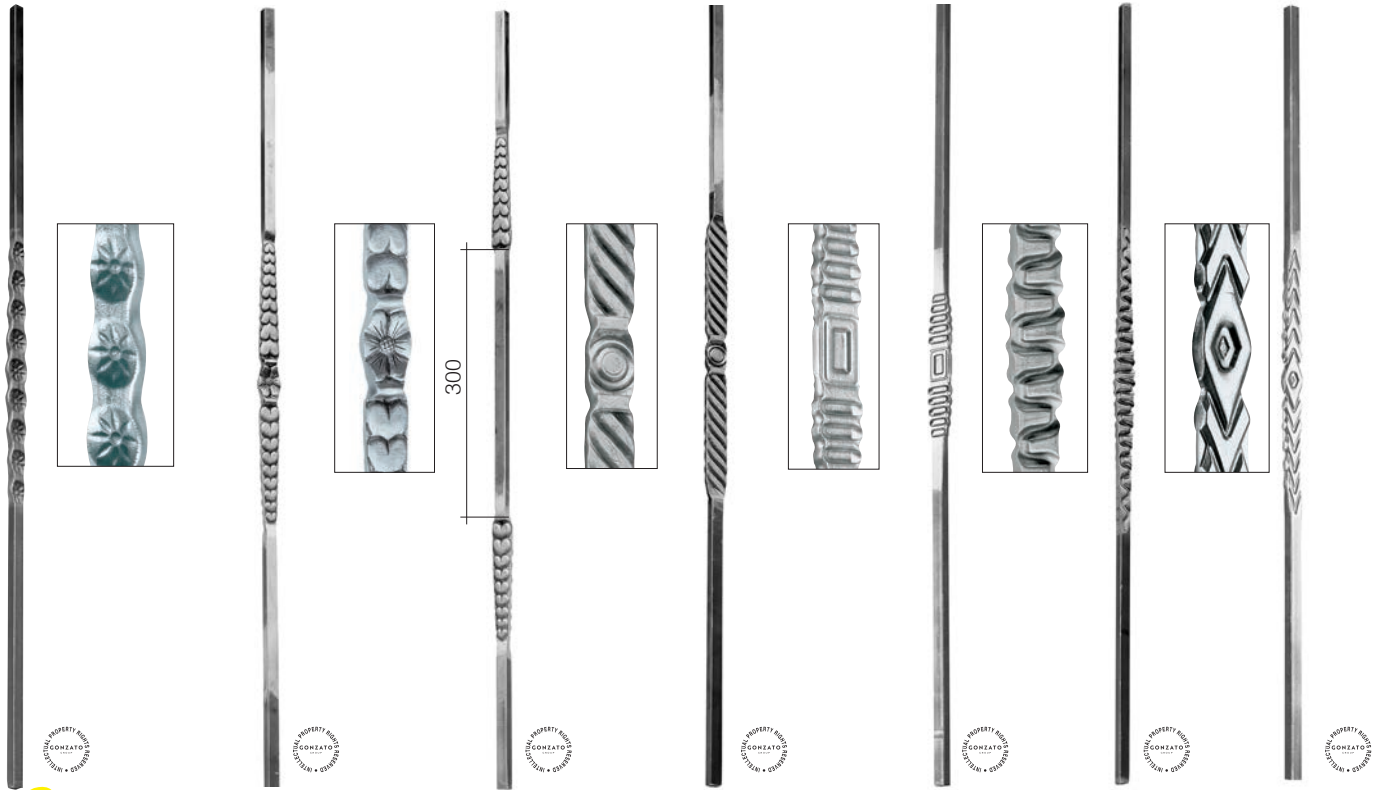

Art. 1718/9

Ø 12 mm
H 1000 mm
Art. 1718/10
Ø 14 mm
H 1000 mm

Art. 1718/13

Ø 12 mm
H 1000 mm
Art. 1718/14
Ø 14 mm
H 1000 mm

Art. 1718/16

Ø 14 mm
H 1000 mm

Art. 1718/3

Ø 12 mm
H 1000 mm

Art. 1718/5

Ø 12 mm
H 1000 mm
Art. 1718/6
Ø 14 mm
H 1000 mm

Art. 1718/2

Ø 14 mm
H 1000 mm

Art. 1718/7

Ø 12 mm
H 1000 mm



Newel Post - Caposaldo

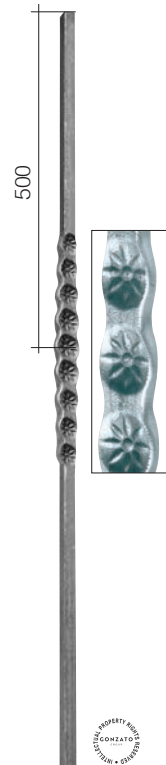

Art. 1718/18
Ø 25 mm
H 1200 mm

Newel Post - Caposaldo

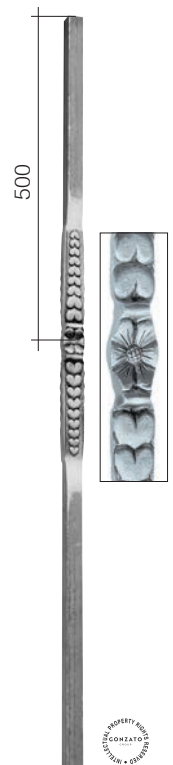

Art. 1718/17
Ø 25 mm
H 1200 mm



Art. GD273/2
Ø 14 x 14 mm
H 1000 mm



Art. GD273/4
Ø 14 x 14 mm
H 1000 mm



Art. GD273/5
Ø 12 x 12 mm
H 1000 mm
Art. GD273/6
Ø 14 x 14 mm
H 1000 mm



Art. GD274/1
Ø 12 x 12 mm
H 1000 mm
Art. GD274/2
Ø 14 x 14 mm
H 1000 mm

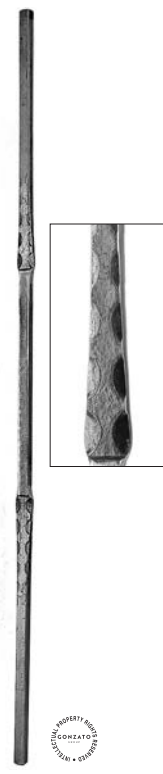

Art. GD274/5
Ø 12 x 12 mm
H 1000 mm
Art. GD274/6
Ø 14 x 14 mm
H 1000 mm



Art. GD274/3
Ø 12 x 12 mm
H 1000 mm
Art. GD274/4
Ø 14 x 14 mm
H 1000 mm

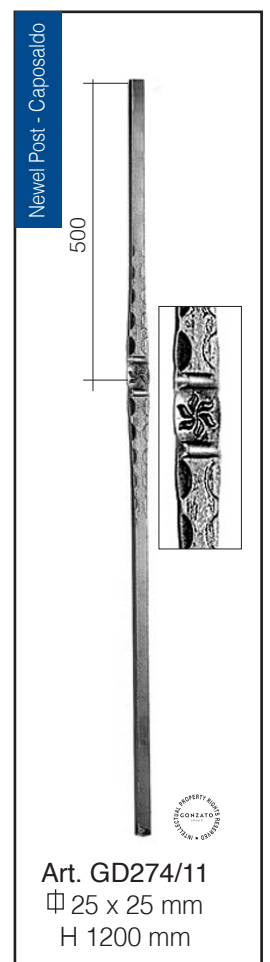

Art. GD274/11
Ø 25 x 25 mm
H 1200 mm

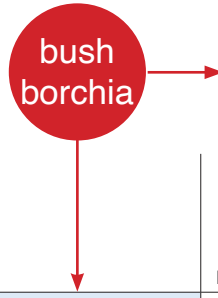

Sec.Sez.	Finish - Finitura	Bush - Borchia	Art.	Art.
Ø 12 mm	Plain Liscio 	1393/19 	1746/1	1746/2
	Hammered Spigolato 		1746/3	1746/4
	Bark effect Corteccia 		1746/5	-
	Plain Liscio 	1391/21 cast steel bush borchia ferro fuso 	1176/1/S	1176/2/S
	Bark effect Corteccia 		1176/3/S	-
Ø 14 mm	Hammered Spigolato 	128/2 	64/1/3	64/1/4
Ø 12 mm	Plain Liscio 	1466/4 brass - ottone 	1179/1	1179/2
	Plain Liscio 	1393/27/S 	1177/5	1177/6
Ø 14 mm	Plain Liscio 	1466/14 lathed bush borchia tornita 	GD275/1	GD275/7
	Plain Liscio 	1393/28/S 	1177/7	1177/8
	Plain Liscio 	1466/13 lathed bush borchia tornita 	GD275/3	GD275/9
	Plain Liscio 	1466/15 lathed bush borchia tornita 	GD275/2	GD275/8
	Plain Liscio 	1466/5 brass - ottone 	1179/3	1179/4

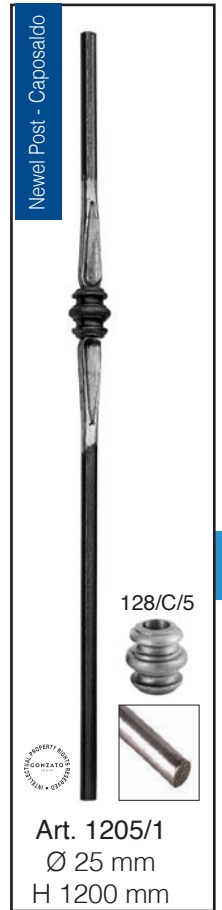

PLAIN PICKETS - PALETTI LISCI
TUBE-TUBO Ø 30 mm THICKN. - SPESS. 1,5 mm



Art. 148/1
Ø 30 mm
H 900 mm



Art. 148/2
Ø 30 mm
H 900 mm



Art. 149/1
Ø 30 mm
H 900 mm



Art. 149/2
Ø 30 mm
H 900 mm



Art. 537/8
Ø 30 mm
H 1000 mm



Art. 537/9
Ø 30 mm
H 1000 mm



Art. 149/4
Ø 30 mm
H 1000 mm



Art. 149/3
Ø 30 mm
H 400 mm



Art. 537/1
Ø 30 mm
H 1000 mm



Art. 537/3
Ø 30 mm
H 1000 mm



Art. 537/4
Ø 30 mm
H 1000 mm



Art. 537/5
Ø 30 mm
H 1000 mm



Art. 537/6
Ø 30 mm
H 1000 mm



Art. 537/7
Ø 30 mm
H 1000 mm

PLAIN PICKETS - PALETTI LISCI
TUBE-TUBO Ø 30 mm THICKN. - SPESS. 1,5 mm

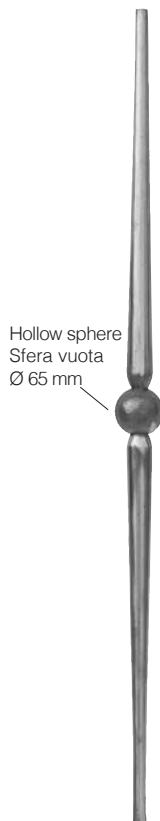

Hollow sphere
Sfera vuota
Ø 65 mm



Art. 1208/5
Ø 30 mm
H 900 mm



Art. 1223/2
Ø 30 mm
H 1000 mm



Squared flattened bush -
Bochia schiacciata quadrata



Art. 536/2
Ø 30 mm
H 900 mm



Thread hole
Foro filetto
Ø 14 MA

Plain tube
Tubo liscio

Art. 1198/7
Ø 30 mm
H 450 mm



Wood
legno
745/2

Art. 530/1
Borchia - bush
Ø 46 mm
H 880 mm



Wood
legno
745/3

Art. 530/2
Borchia - bush
Ø 52 mm
H 880 mm



Wood
legno
745/4

Art. 530/3
Borchia - bush
Ø 57 mm
H 880 mm



Ceramic bushing hand painted
Borchia in ceramica dipinta a mano



Art. 533/2
sphere-sfera
Ø 55 mm
H 890 mm



Art. 533/8



Art. 533/4
sphere-sfera
Ø 30 mm
H 890 mm

TUBE - TUBO Ø 40 mm THICKN. - SPESS. 2 mm



Art. 146/1
Ø 40 mm
H 900 mm



Art. 146/4
Ø 40 mm
H 900 mm

Squared flattened bush - Bochia schiacciata quadrata



Art. 536/3
Ø 40 mm
H 900 mm



Art. 536/4
Ø 40 mm
H 900 mm

Squared flattened bush - Bochia schiacciata quadrata



Art. 145/4
Ø 40 mm
H 1200 mm



Art. 145/5
Ø 40 mm
H 1300 mm



TUBE - TUBO Ø 30 mm THICKN. - SPESS. 1,5 mm



Art. 529/5
Ø 30 mm
H 900 mm



Art. 527/2
Ø 30 mm
H 1000 mm



Art. 527/3
Ø 30 mm
H 1000 mm

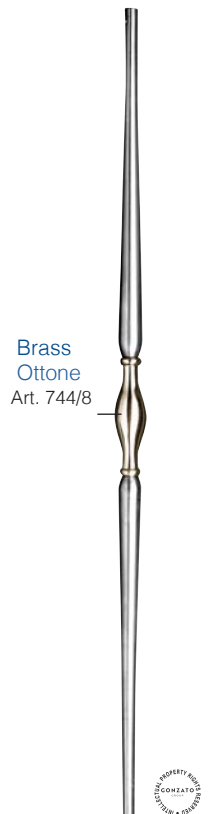

Art. 529/8
Ø 30 mm
H 1000 mm



Art. 525/1
Ø 30 mm
H 930 mm



Art. 144/3
Ø 30 mm
H 900 mm

STEEL TUBE BALUSTERS - TUBO DI ACCIAIO Ø 40 mm THICKN. - SPESS. 2 mm



Art. 1793/5
Ø 40 mm
H 1000 mm



Art. 146/2
Ø 40 mm
H 1000 mm



Art. 146/3
Ø 40 mm
H 900 mm



Art. 147/1
Ø 40 mm
H 1000 mm



Art. 147/2
Ø 40 mm
H 1000 mm



Art. 1793/4
Ø 50 mm
H 1000 mm

Tube - Tubo Ø 50 x 2 mm

TUBE - TUBO Ø 30 mm
THICKN. - SPESS. 1,5 mm

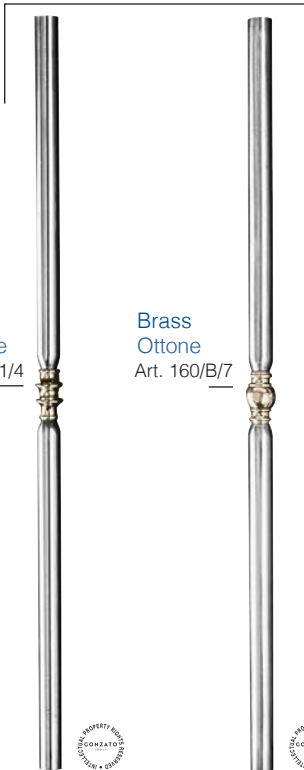

Brass
Ottone
Art. 161/4

Brass
Ottone
Art. 160/B/7

Art. 529/1
Ø 30 mm
H 900 mm

Art. 529/4
Ø 30 mm
H 900 mm



Art. 810/1
Art. 810/2

Tube-Tubo
60 x 60 mm

220

Art. 1207/1
L 85 mm
H 1200 mm



Art. 810/1
Art. 810/2

Tube-Tubo
80 x 80 mm

220

Art. 1207/2
L 105 mm
H 1200 mm



Art. 810/2
Art. 810/3

Tube-Tubo
Ø 100 mm

Art. 1247/2
Ø 135 mm
H 1000 mm

GROOVED PICKETS - PALETTI RIGATI
TUBE-TUBO Ø 30 mm THICKN. - SPESS. 1,5 mm

Some Arterferro tubular pickets appear in the film "007 GoldenEye" (1995) directed by Martin Campbell

Alcuni paletti in tubo Arterferro appaiono nel film "007 GoldenEye" (1995) diretto da Martin Campbell



Art. 1794/10
Ø 30 x 1,5 mm
L 3000 mm
Art. 1794/10/6000
Ø 30 x 1,5 mm
L 6000 mm

Art. 1231/1 Ø 30 mm H 1000 mm	Art. 1229/1 Ø 30 mm H 1000 mm	Art. 1231/2 Ø 30 mm H 1000 mm	Art. 1229/2 Ø 30 mm H 1000 mm	Art. 1229/4 Ø 30 mm H 1000 mm	Art. 1229/5 Ø 30 mm H 1000 mm
-------------------------------------	-------------------------------------	-------------------------------------	-------------------------------------	-------------------------------------	-------------------------------------



Art. 1231/3
Ø 30 mm
H 1000 mm



Art. 1230/2
Ø 30 mm
H 1000 mm



Art. 1230/1
Ø 30 mm
H 1000 mm



Art. 1229/6
Ø 30 mm
H 1000 mm



Art. 1229/8
Ø 30 mm
H 500 mm

GROOVED PICKETS - PALETTI RIGATI
TUBE-TUBO Ø 30 mm THICKN. - SPESS. 1,5 mm



Brass
Ottone
Art. 160/D/12

Art. 1233/2
Ø 30 mm
H 1000 mm

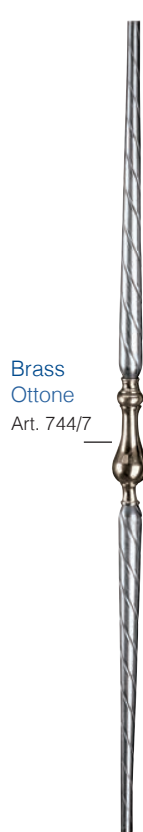

Brass
Ottone
Art. 744/7

Art. 1233/3
Ø 30 mm
H 1000 mm

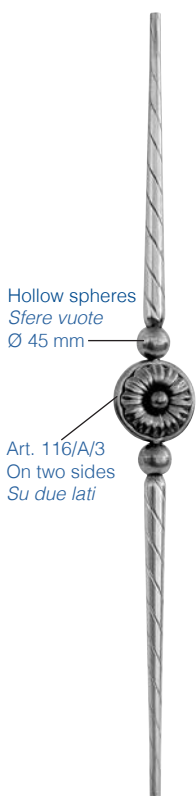

Hollow spheres
Sfere vuote
Ø 45 mm

Art. 116/A/3
On two sides
Su due lati

Art. 1239/1
Ø 30 mm
113 x 1030 mm



Thread hole
Foro filetto
Ø 14 MA

Grooved tube
Tubo rigato

Art. 1198/8
Ø 30 mm
H 450 mm



Newel Post - Caposaldo

Brass
Ottone

Art. 160/42

PROPERTY RIGHTS
RESERVED

Art. 1794/6
Ø 40 mm
H 1200 mm



Art. 1794/1
Ø 40 mm
H 1000 mm



Art. 1794/2
Ø 40 mm
H 1000 mm

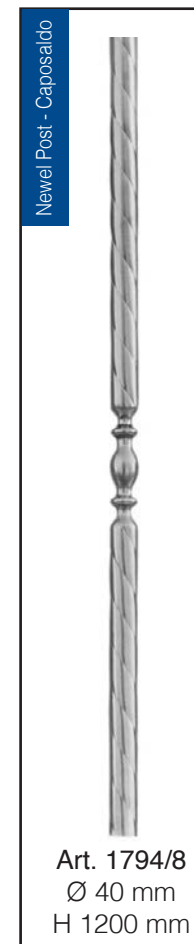

Newel Post - Caposaldo





Art. 1794/8
Ø 40 mm
H 1200 mm



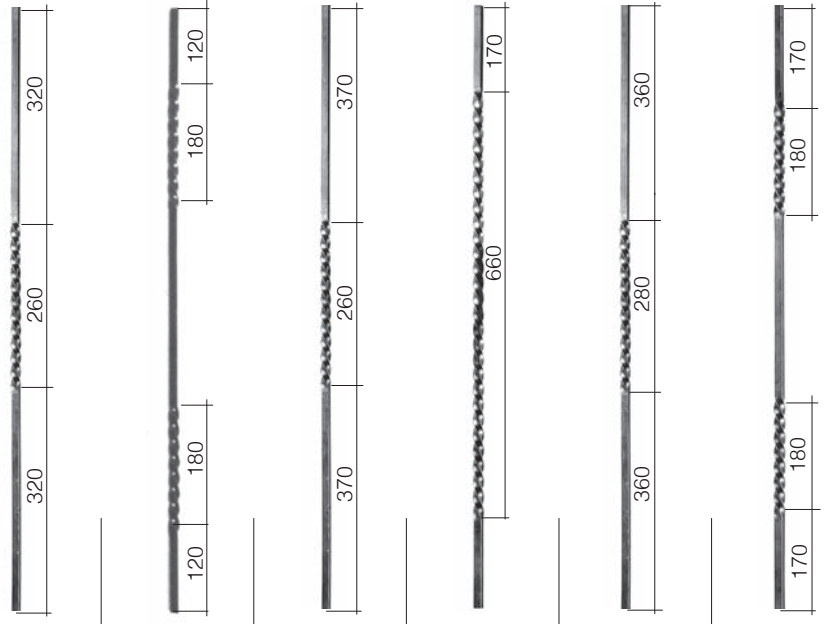



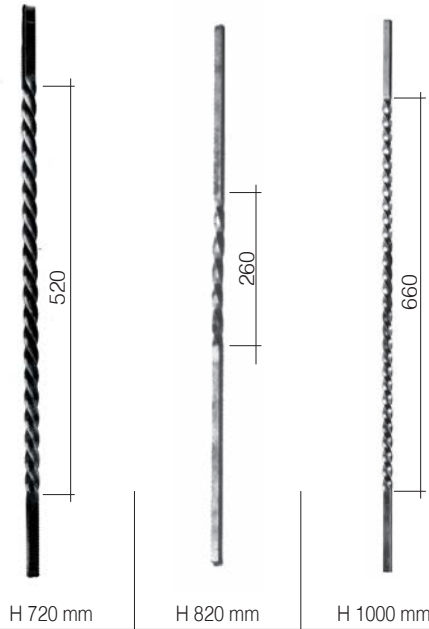

Grooved tube
Tubo rigato

Art. 1794/9
Ø 40 x 2 mm
L 3000 mm
Art. 1794/9/6000
Ø 40 x 2 mm
L 6000 mm



Sec.Sez.	Finish - Finitura	H 900 mm	H 900 mm	H 1000 mm	H 1000 mm	H 1000 mm	H 1000 mm
Art.	Art.	Art.	Art.	Art.	Art.	Art.	Art.
Ø 12 mm	Plain Liscio 	65/8	53/3	-	1148/2	1148/5	1148/8
	Hammered Spigolato 	-	-	-	-	-	-
	Bark effect Corteccia 	-	-	-	1148/11	-	1148/17
	Grooved Rigato 	118/H/2	118/H/1	118/H/30	1151/7	1151/5	1151/6
Ø 14 mm	Plain Liscio 	70/D/3	-	-	1148/3	1148/6	1148/9



Sec.Sez.	Finish - Finitura	H 720 mm	H 820 mm	H 1000 mm
Art.	Art.	Art.	Art.	Art.
Ø 8 mm	Plain Liscio 	119/7	-	-
Ø 8 mm	Grooved Rigato 	-	-	-
Ø 10 mm	Plain Liscio 	-	-	1148/1
Ø 12 mm	Plain Liscio 	-	65/7	-
∇ 14 x 8 mm	Plain Liscio 	-	-	1148/19



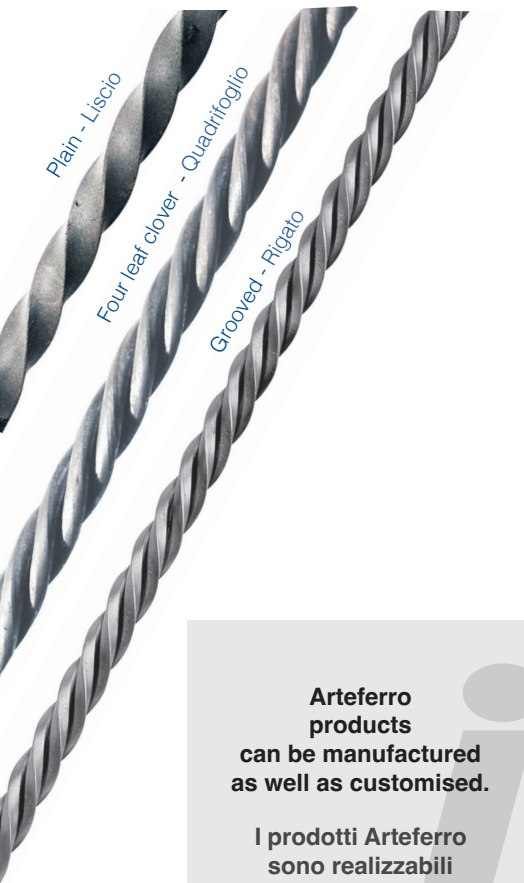













Arteferro products can be manufactured as well as customised.

I prodotti Arteferro sono realizzabili anche su misura.

**TWISTS WITH TRIPLE TWISTING RIGHT/LEFT
TORCIGLIONI CON TRIPLA ATTORCIGLIATURA DESTRA/SINISTRA**

Sec.Sez.	Finish - Finitura	H 900 mm			H 1000 mm			H 1200 mm		
		Art.	Art.	Art.	Art.	Art.	Art.	Art.	Art.	
Φ 12 mm	Plain Liscio 	GD106/1	-	GD106/7						
	Four-leaf clover Quadrifoglio 	GD106/10	GD106/13	-						
	Grooved Rigato 	GD106/19	GD106/22	-						
Φ 14 mm	Plain Liscio 	GD106/2	GD106/5	GD106/8						
	Four-leaf clover Quadrifoglio 	GD106/11	GD106/14	GD106/17						
	Grooved Rigato 	GD106/20	GD106/23	GD106/26						
Φ 16 mm	Plain Liscio 	GD106/3	GD106/6	GD106/9						
	Four-leaf clover Quadrifoglio 	GD106/12	GD106/15	GD106/18						
	Grooved Rigato 	GD106/21	GD106/24	GD106/27						



Sezione	Finish - Finitura	H 1200 mm		H 1200 mm		H 1200 mm		H 1200 mm		H 1000 mm	
		Art.	Art.	Art.	Art.	Art.	Art.	Art.	Art.	Art.	
Φ 20 mm	Plain Liscio 	-	113/7	-	119/25	1751/5					
Φ 25 mm	Beveled Smussato 	112/3	-	-	-	-					
Φ 30 mm	Plain Liscio 	-	113/8	GD22/6	119/27	-					



Section Sezione	Finish - Finitura	H 720 mm A = 520 mm	H 820 mm A = 620 mm	H 900 mm A = 700 mm	H 1200 mm A = 900 mm
		Art.	Art.	Art.	Art.
16 x 4 mm	Plain Liscio 	119/4	119/11	119/18 BEST PRICE	-
20 x 4 mm		-	119/12	119/19	-
20 x 6 mm		119/6	119/13	119/20	-
30 x 8 mm		-	-	118/H/3	118/H/4

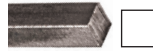

Section Sezione	Finish - Finitura	H 720 mm A = 520 mm	H 820 mm A = 620 mm	H 900 mm A = 700 mm
		Art.	Art.	Art.
12 x 12 mm	Plain - Plain 	119/9	119/16	119/23
14 x 14 mm		119/10	119/17	119/24



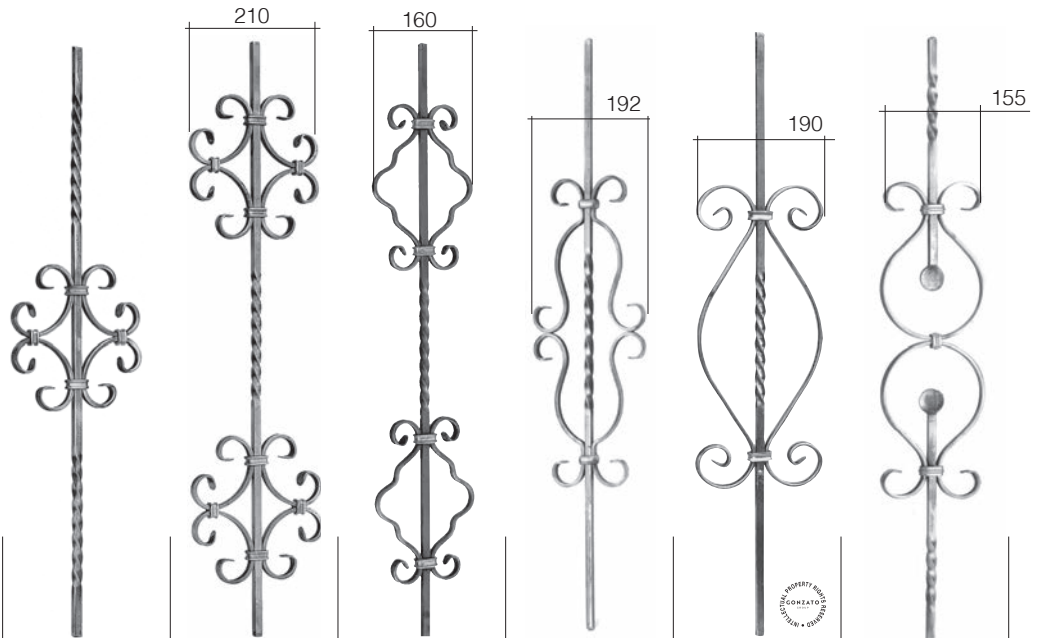

Sec.Sez.	Finish - Finitura	Art.	Art.	Art.	Art.	Art.	Art.
Ø 12 mm	Plain Liscio	584/1	584/2	1127/2	64/E/3	539/1	134/H/1

Pag.
40

Large choice
of twisted bars
3m long

Ampia
scelta di barre
attorcigliate 3 mt.

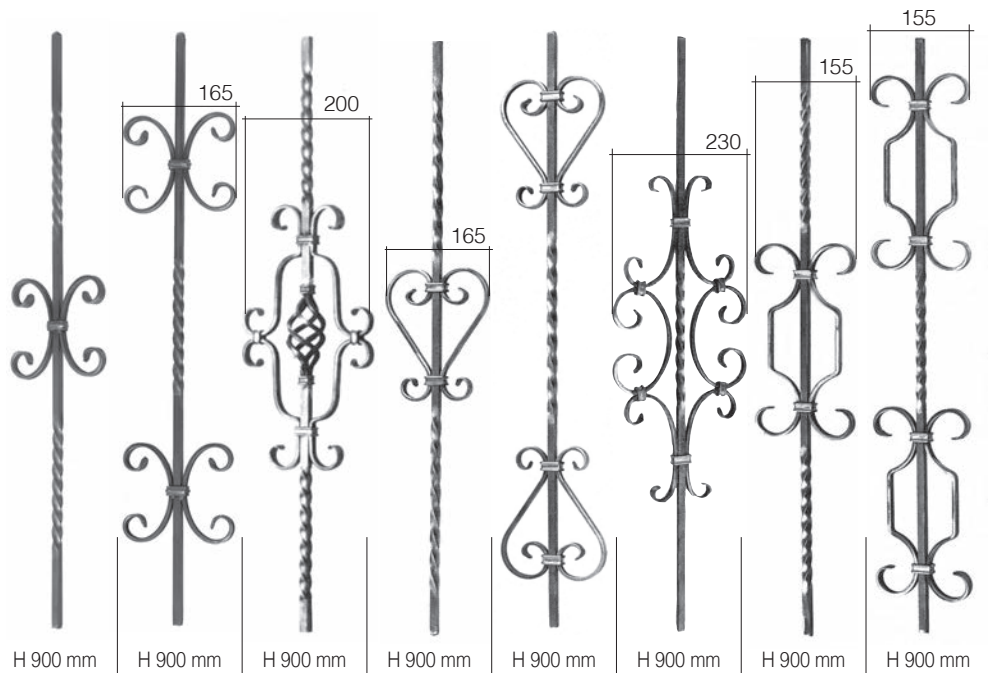

Sec.Sez.	Finish - Finitura	Art.	Art.	Art.	Art.	Art.	Art.	Art.
Ø 12 mm	Plain Liscio	584/4	584/5	64/B/2	584/B/2	584/B/1	584/A/6	584/A/5
Ø 14 mm	Plain Liscio	-	-	64/B/5	-	-	-	-

Plain - Liscio



H 900 mm



H 1000 mm



H 1000 mm



H 900 mm

Art. 138/4

12 x 6 mm

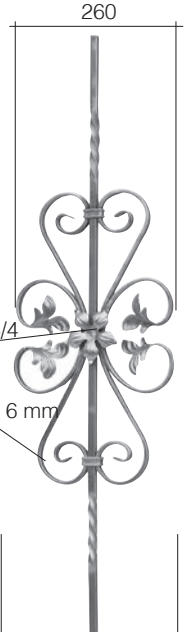

H 1000 mm

Sec.Sez.	Finish - Finitura	Art.	Art.	Art.	Art.	Art.	Art.
Φ 12 mm	Plain Liscio	584/B/3	1124/1	1124/2	52/F/1	1753/3	1753/6



H 900 mm



H 900 mm





H 1000 mm

Sec.Sez.	Finish - Finitura	Art.	Art.	Art.
Φ 12 mm	Plain Liscio	52/A/3	52/A/5	52/A/2

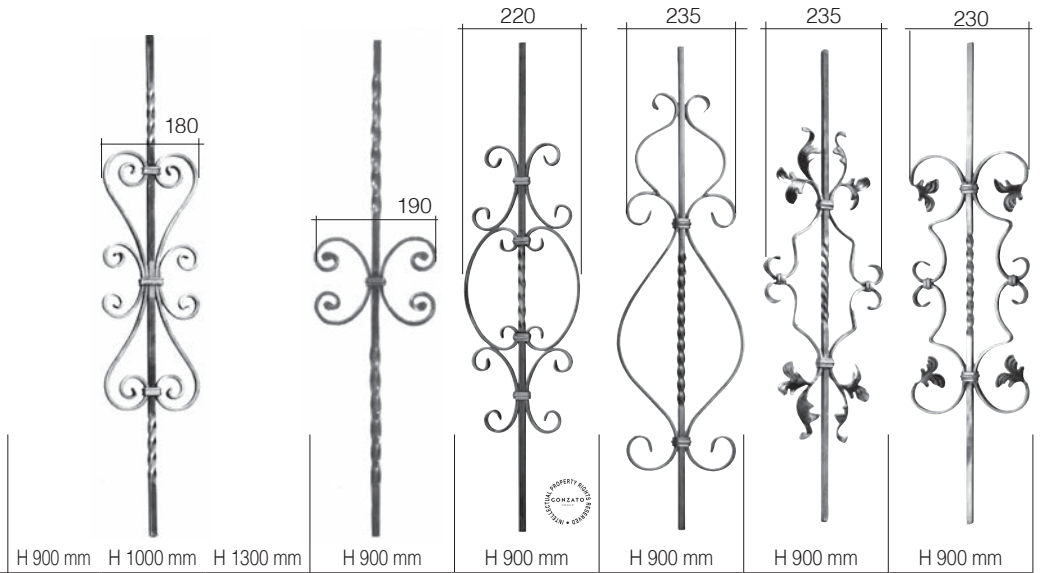



Sec.Sez.	Finish - Finitura	Art.	Art.	Art.	Art.	Art.	Art.	Art.	Art.
∅ 12 mm	Plain Liscio 	49/3	1753/1	-	51/1	1124/3	134/F/8	53/1	52/E/4
∅ 14 mm	Plain Liscio 	49/5	-	49/7	51/4	-	-	-	-

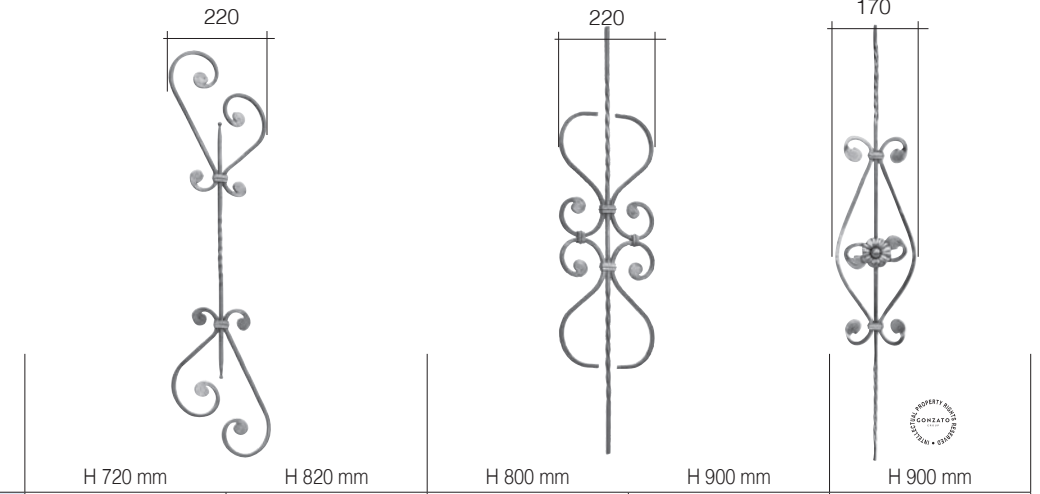

Sec.Sez.	Finish - Finitura	Art.	Art.	Art.	Art.	Art.
∅ 8 mm	Plain Liscio 	55/5	55/6	56/3	56/4	538/1

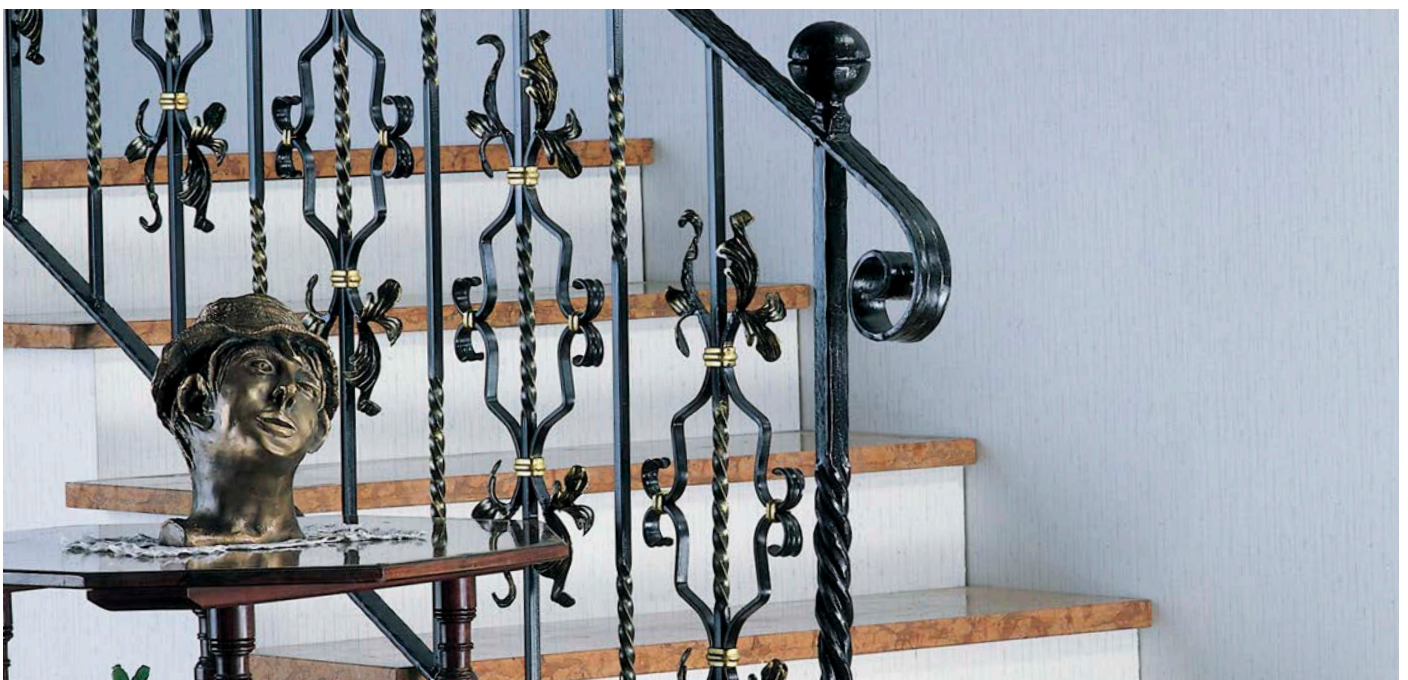



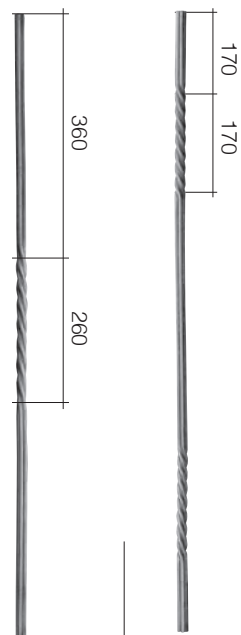

Four leaf clover - Quadrifoglio



H 1000 mm

H 1000 mm

Sec.Sez.	Finish - Finitura	Art.	Art.
Ø 14 mm	Four-leaf clover Quadrifoglio 	1150/9	1150/10
Ø 16 mm	Four-leaf clover Quadrifoglio 	1150/12	1150/13



Plain - Liscio



H 1000 mm

Sec.Sez.	Finish - Finitura	Art.
Ø 12 mm	Plain Liscio 	1122/2



Art. 66/5
16 x 12 mm
180 x 720 mm
Art. 66/7
16 x 12 mm
180 x 900 mm



Art. 97/1
14 x 14 mm
130 x 830 mm

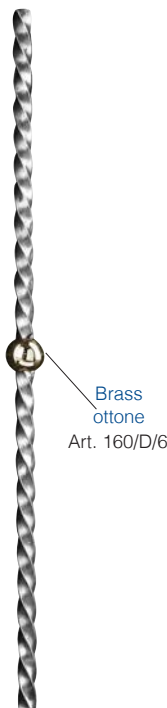

Art. 529/7
20 x 20 mm
H 1000 mm



Art. 60/2
20 x 4 mm
175 x 820 mm

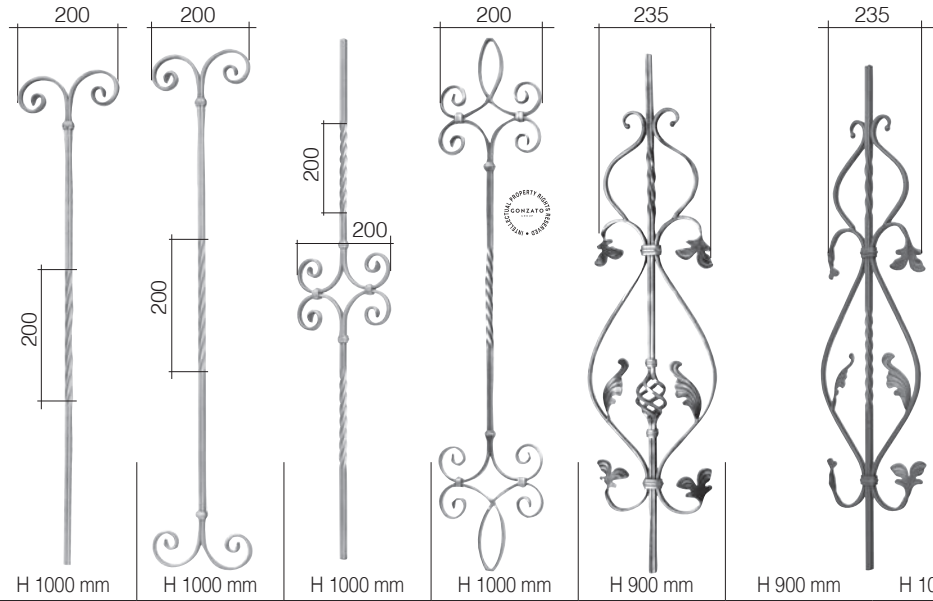

Sec.Sez.	Finish Finitura	Art.	Art.	Art.	Art.	Art.	Art.	Art.
∅ 12 mm	Grooved Rigato 	1695/1	1695/3	1695/6	1688/3	52/E/3	52/2	1753/7



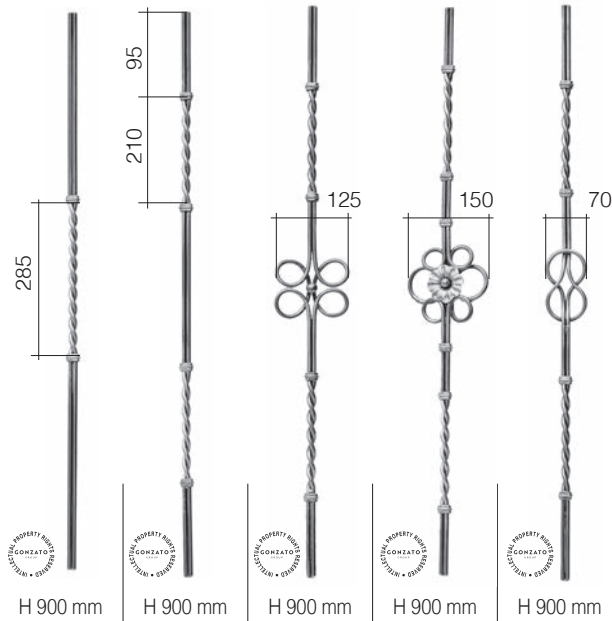
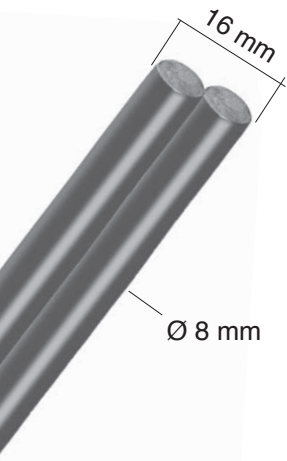

Sec.Sez.	Finish - Finitura	H 900 mm	H 900 mm	H 900 mm	H 900 mm	H 900 mm
Ø 8 mm	Plain Liscio	Art. 617/7	Art. 617/6	Art. 615/3	Art. 615/1	Art. 615/4

BEST PRICE

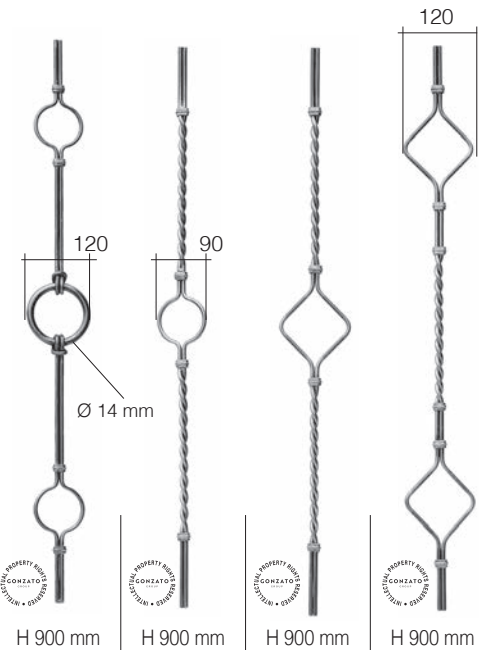

Sec.Sez.	Finish - Finitura	H 900 mm	H 900 mm	H 900 mm	H 900 mm
Ø 8 mm	Plain Liscio	Art. 615/2	Art. 617/1	Art. 617/3	Art. 617/4



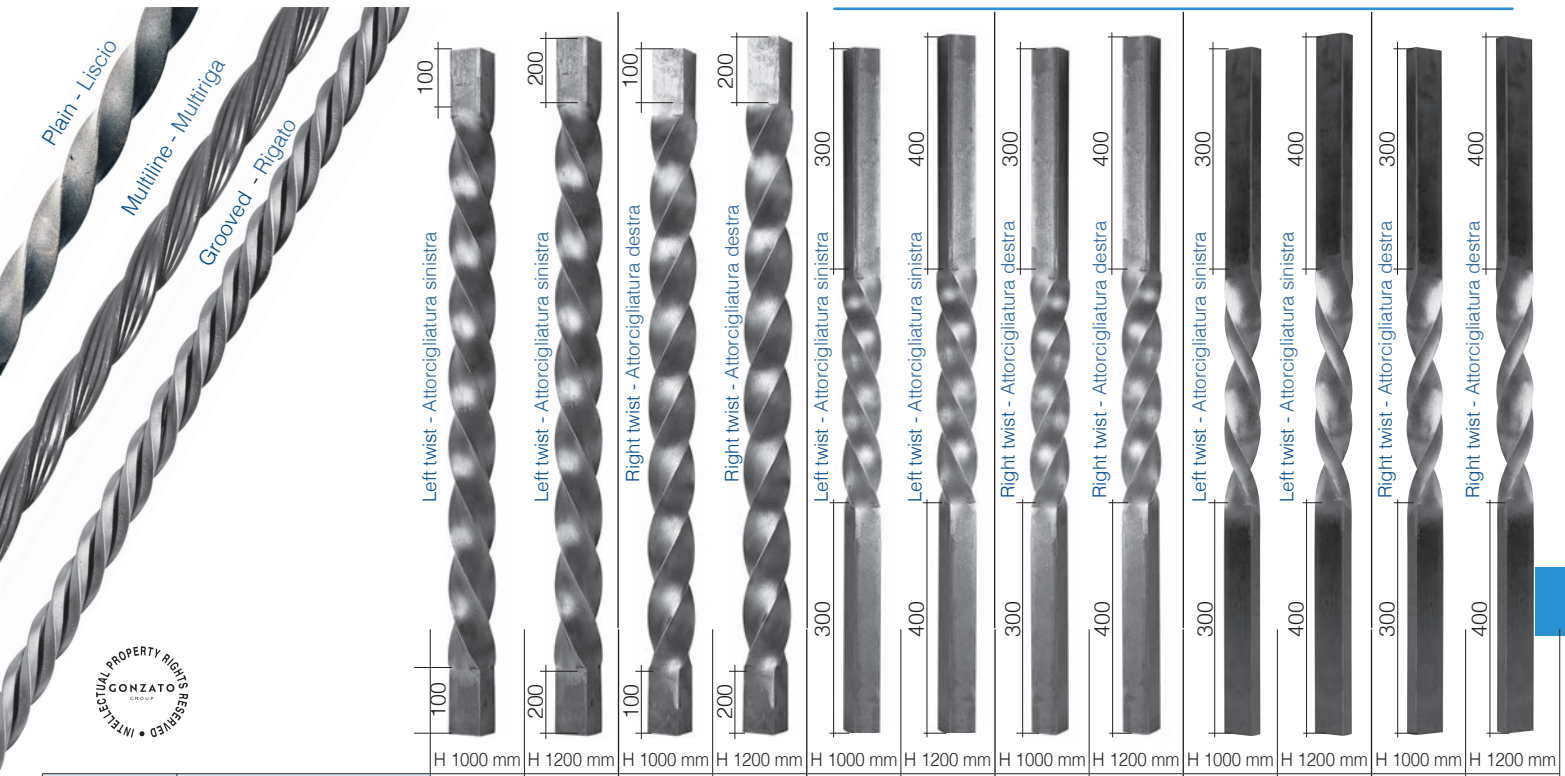

Sec.Sez.	Finish - Finitura	Art.	Art.	Art.	Art.	Art.	Art.	Art.	Art.	Art.	Art.	Art.	Art.
Ø 30 mm	Plain Liscio	119/27	1724/20	1724/25	1724/26	1724/31	1724/32	1724/37	1724/38	-	-	-	-
	Multiline Multiriga	1725/5	1725/6	1725/11	1725/12	-	1725/18	1725/23	1725/24	-	-	-	-
	Grooved Rigato	1724/43	1724/44	1724/49	1724/50	1724/55	1724/56	1724/61	-	-	-	-	
Ø 40 mm	Plain Liscio	119/28	1724/19	1724/23	1724/24	1724/29	1724/30	1724/35	1724/36	-	-	-	-
	Multiline Multiriga	1725/3	1725/4	1725/9	1725/10	1725/15	-	-	1725/22	-	-	-	-
	Grooved Rigato	1724/41	1724/42	1724/47	1724/48	1724/53	1724/54	1724/59	1724/60	-	-	-	-
Ø 50 mm	Plain Liscio	1724/17	1724/18	1724/21	-	1724/27	1724/28	1724/33	1724/34	-	-	-	-
	Multiline Multiriga	1725/1	1725/2	1725/7	1725/8	1725/13	-	1725/19	-	-	-	-	-
	Grooved Rigato	1724/39	1724/40	-	1724/46	1724/51	1724/52	1724/57	1724/58	-	-	-	-
∇ 50 x 25 mm	Plain Liscio	1724/3	1724/4	1724/7	1724/8	-	-	-	-	1724/11	1724/12	1724/15	1724/16
∇ 60 x 30 mm	Plain Liscio	1724/1	1724/2	1724/5	1724/6	-	-	-	-	1724/9	1724/10	1724/13	1724/14

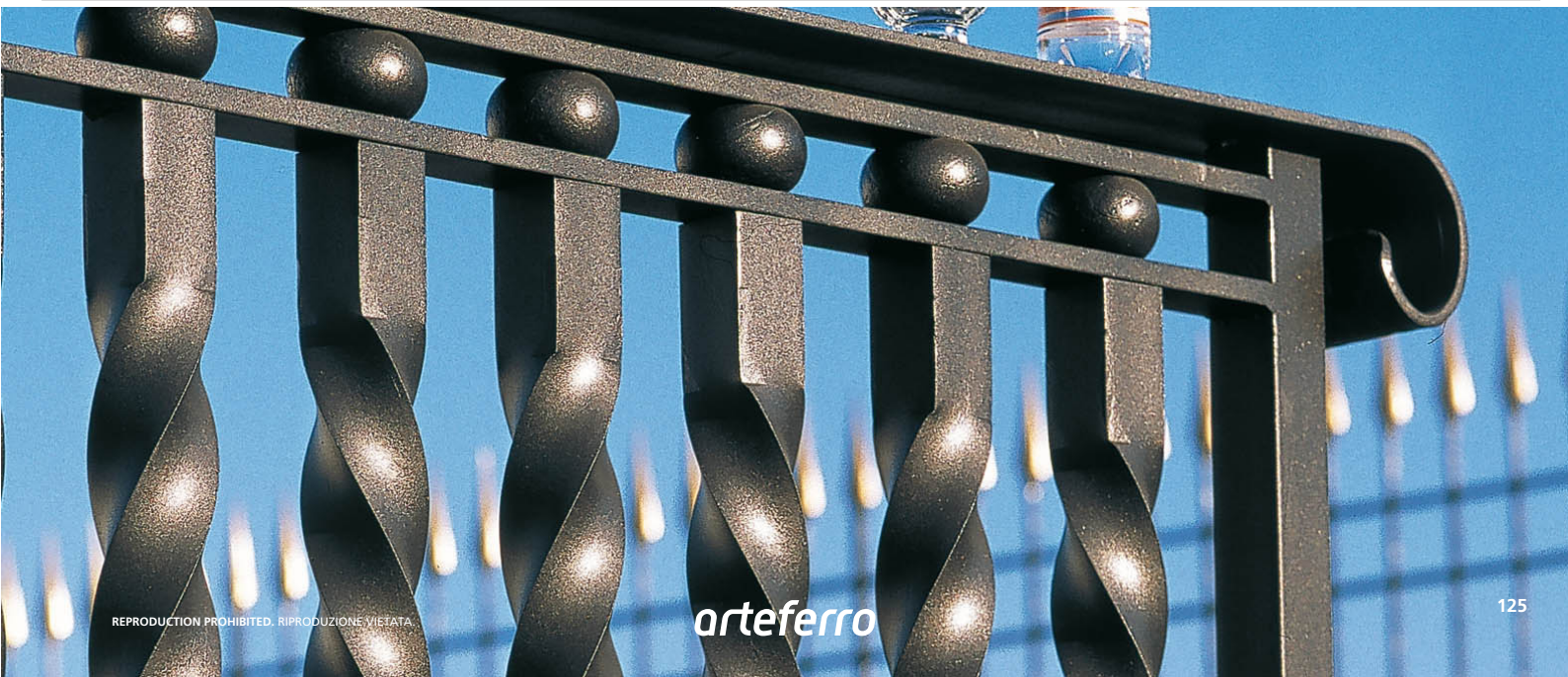



159/3 \varnothing 12 mm
159/4 \varnothing 14 mm
159/5 \varnothing 16 mm

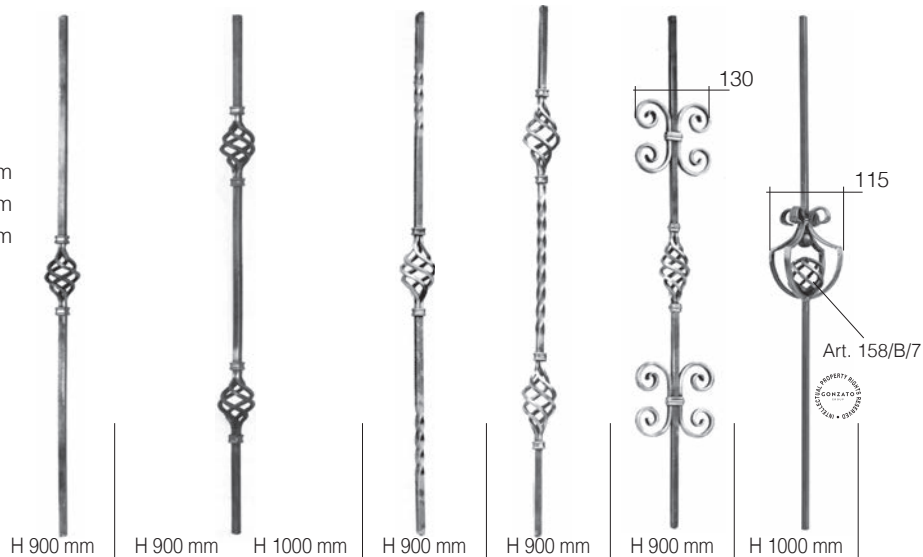

Sec.Sez.	Finish - Finitura		Art.	Art.	Art.	Art.	Art.	Art.	Art.
\varnothing 12 mm	Plain Liscio		48/A/2	48/A/1	-	48/2	48/1	48/5	1058/1
	Hammered Spigolato		48/4	48/3	-	-	-	-	-
	Hammered Martellato		48/A/4	-	-	-	-	-	-
	Grooved Rigato		-	-	1151/4	-	-	-	-
	Bark effect Corteccia		-	48/A/12	1733/17	-	-	-	-
\varnothing 14 mm	Plain Liscio		48/A/6	48/A/5	-	48/7	48/6	-	-
	Hammered Spigolato		48/9	48/8	-	-	-	-	-
	Hammered Martellato		48/A/8	48/A/7	-	-	-	-	-
	Bark effect Corteccia		-	-	1733/19	-	-	-	-
\varnothing 16 mm	Plain Liscio		48/A/10	48/A/9	-	48/12	48/11	-	-
	Hammered Spigolato		48/14	48/13	-	-	-	-	-
	Hammered Martellato		48/A/12	48/A/11	-	-	-	-	-



1466/12

brass-ottone



Sec.Sez.	Finish - Finitura		Art.	Art.
\varnothing 12 mm	Plain Liscio		1149/1	1149/2



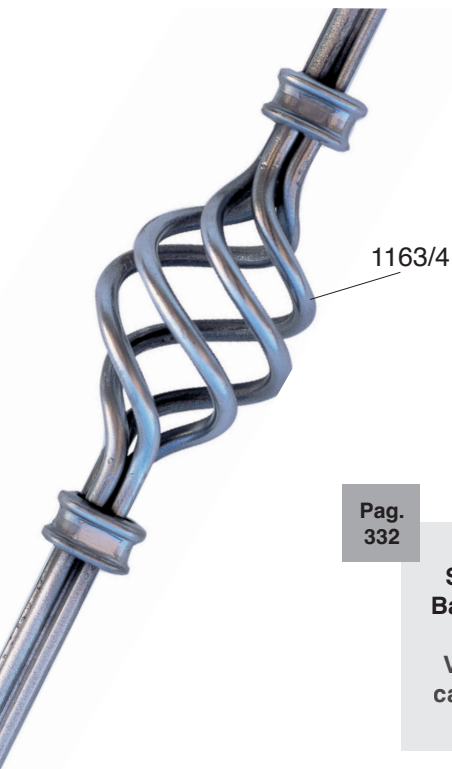

1163/4



Pag.
332

See also the
Basket section

Vedi anche il
capitolo Pigne



H 1000 mm H 1000 mm

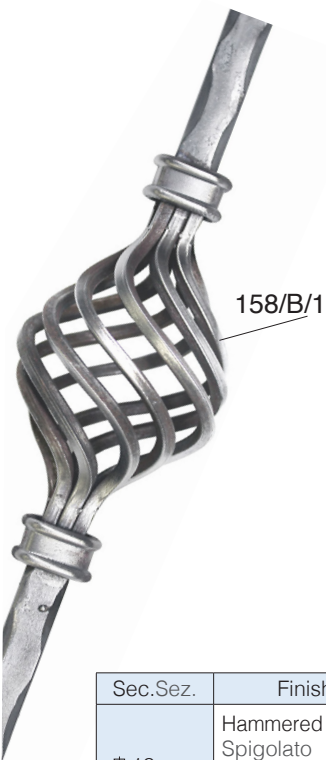

Sec.Sez.	Finish - Finitura	Art.	Art.
Ø 12 mm	Four-leaf clover Quadrifoglio 	-	1150/2
Ø 14 mm	Four-leaf clover Quadrifoglio 	1150/5	-



158/B/1



H 900 mm H 900 mm H 900 mm H 900 mm

Sec.Sez.	Finish - Finitura	Art.	Art.	Art.	Art.
Ø 12 mm	Hammered Spigolato 	48/B/2	48/B/1	-	-
	Hammered Martellato 	-	-	48/B/8	48/B/7



Arteferro products can be manufactured as well as customised.

I prodotti Arteferro sono realizzabili anche su misura.





Sec.Sez.	Finish - Finitura	H 1100 mm	H 1100 mm	H 1100 mm	H 1100 mm	H 1100 mm	H 1100 mm	H 1200 mm	H 1200 mm
		Art.	Art.	Art.	Art.	Art.	Art.	Art.	Art.
Φ 20 mm	Plain Liscio	113/1	-	112/B/9	-	112/B/15	-	1149/7	-
	Hammered Spigolato	-	113/3	-	-	-	-	-	1149/8
Φ 25 mm	Plain Liscio	-	-	-	-	-	-	-	-
Φ 30 mm	Plain Liscio	113/2	-	112/B/10	-	112/B/16	-	-	-
	Hammered Spigolato	-	113/4	-	-	-	112/B/14	-	-
	Hammered Martellato	-	-	-	112/B/12	-	-	-	-

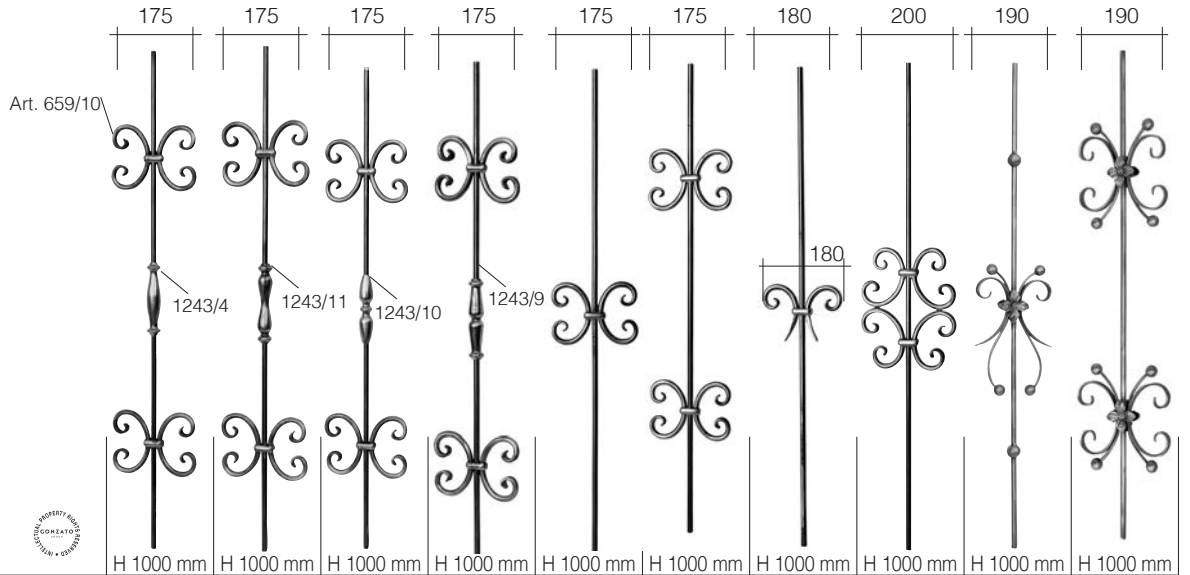

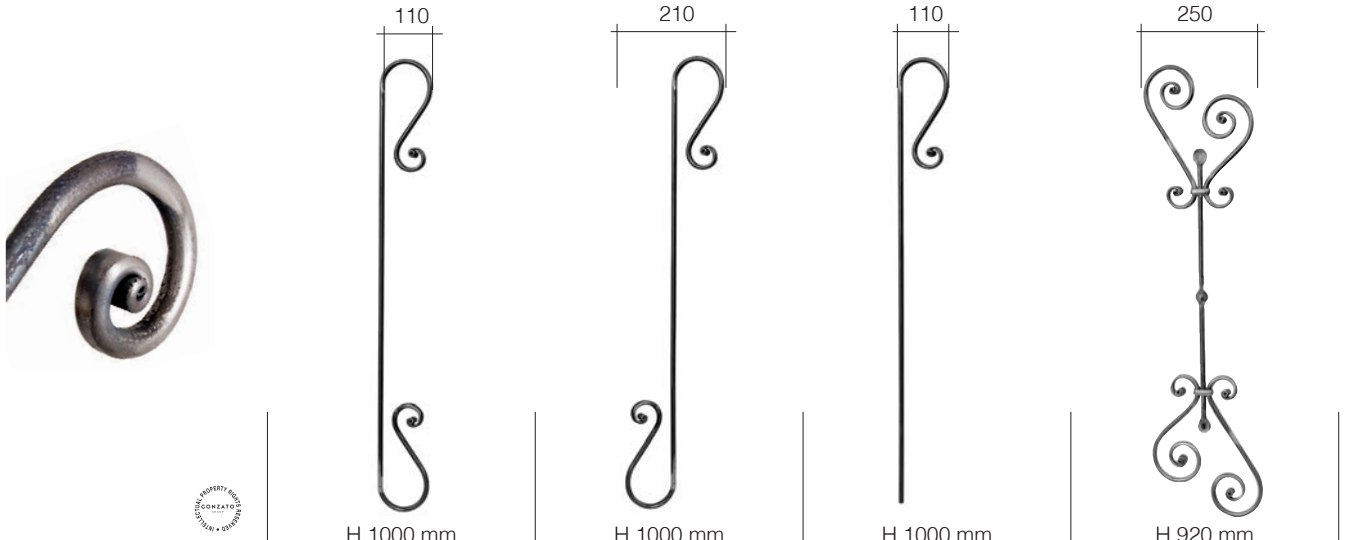

Sec.Sez.	Finish - Finitura	Art.	Art.	Art.	Art.	Art.	Art.	Art.	Art.	Art.	Art.
Ø 12 mm	Plain Liscio 	1068/1	1068/2	1068/3	1068/4	1066/1	1066/2	1066/3	1066/6	1060/3	1061/2



Sec.Sez.	Finish - Finitura	Art.	Art.	Art.	Art.
Ø 12 mm	Plain Liscio 	1071/3	1071/4	1071/5	1071/1

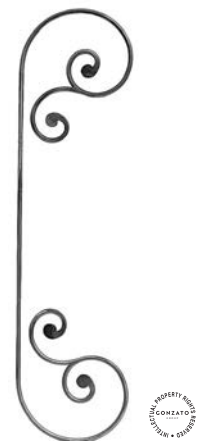

Art. 1292/3
Ø 10 mm
230 x 900 mm





Art. 1053/2
Ø 12 mm
180 x 270 mm

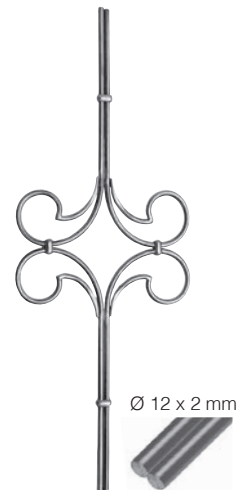
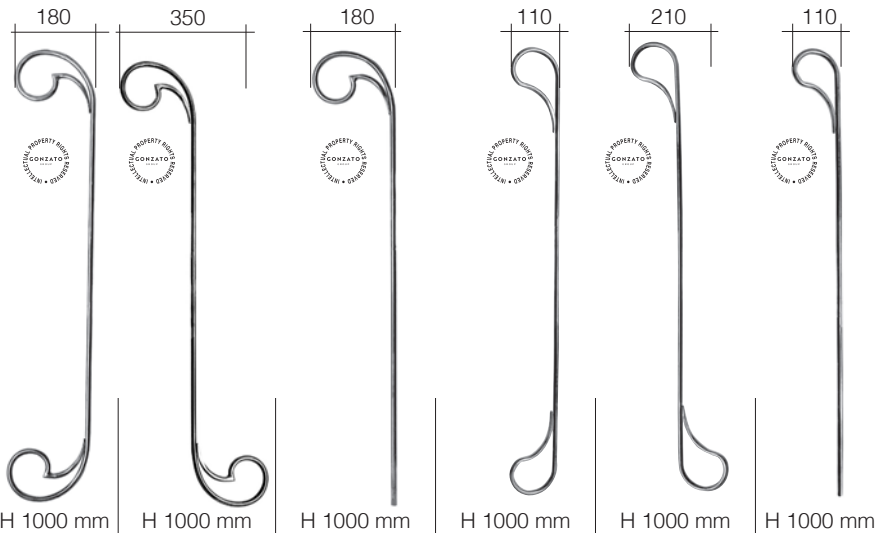

Ø 12 x 2 mm

Sec. Sez.	Finish - Finitura	Art.	Art.	Art.	Art.	Art.	Art.
Ø 12 mm	Plain Liscio 	1054/1	1054/2	1054/3	1054/4	1054/5	1054/6

Art. 1053/1
Ø 24 x 12 mm
360 x 1000

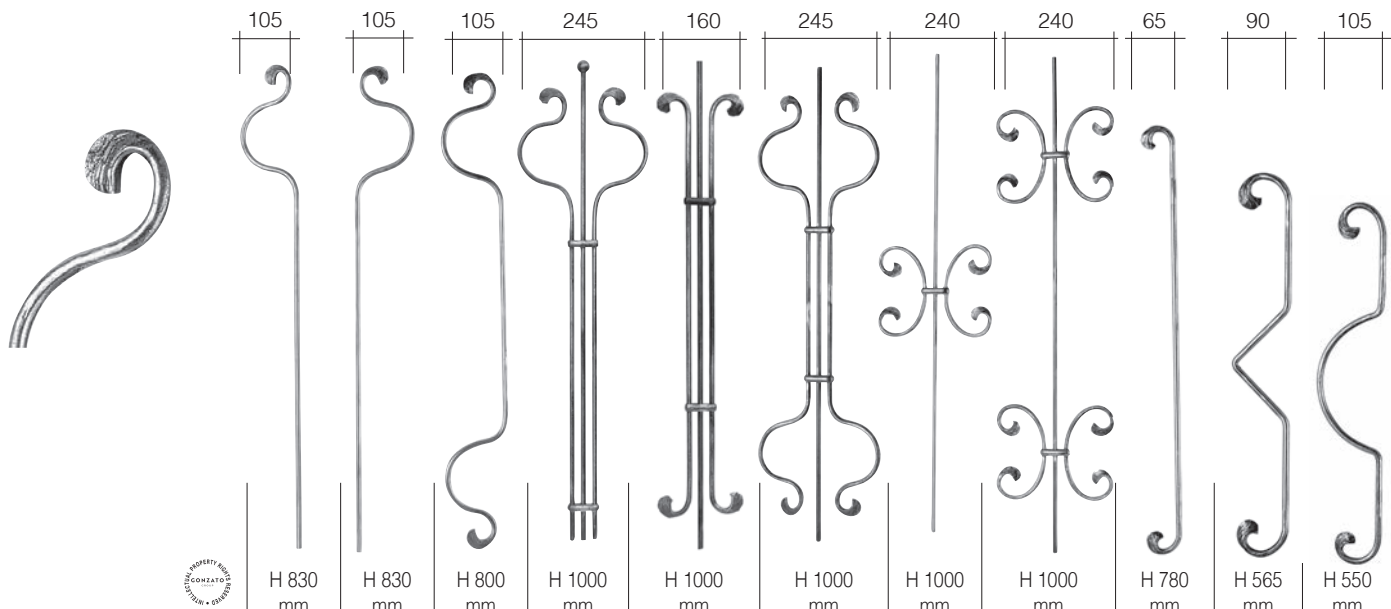

Sec. Sez.	Finish Finitura	Art.	Art.	Art.	Art.	Art.	Art.	Art.	Art.	Art.	Art.	
Ø 10 mm	Plain Liscio 	1303/1	1303/2	1303/3	1075/1	1073/3	1075/2	1073/1	1073/2	1303/4	1303/5	1303/6



Sec.Sez.	Finish - Finitura	Art.	Art.	Art.	Art.	Art.	Art.	Art.
Ø 8 mm	Plain Liscio 	586/3	56/1	56/6	466/2	467/1	468/1	469/1

Sec.Sez.	Finish - Finitura	Art.	Art.	Art.	Art.	Art.
Ø 8 mm	Plain Liscio 	465/1	466/1	468/3	468/4	468/2

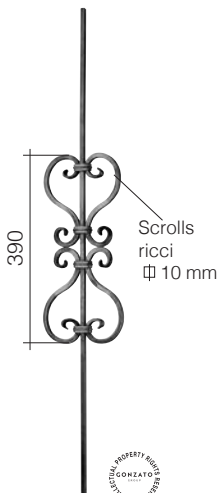

Art. 1125/2
Ø 10 x 10 mm
175 x 1000 mm

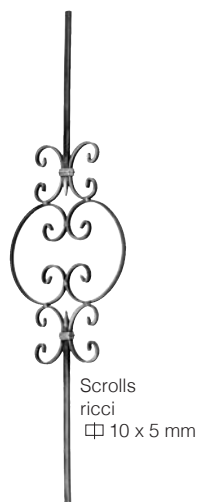

Art. 134/F/4
Ø 10 x 10 mm
250 x 900 mm

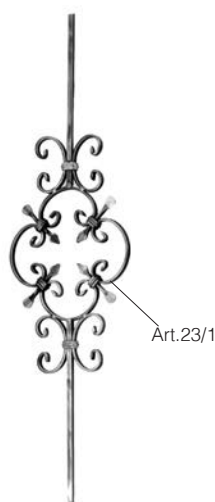

Art. 134/F/3
Ø 10 x 10 mm
250 x 900 mm



Art. 134/G/1
Ø 12 x 12 mm
140 x 900 mm



Art. 134/G/2
Ø 12 x 12 mm
140 x 900 mm

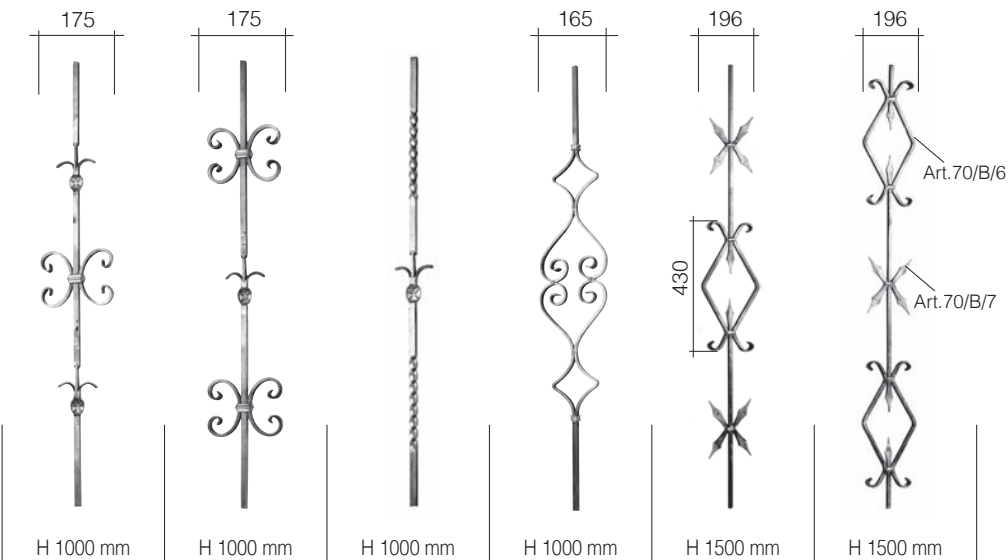

Sec.Sez.	Finish - Finitura	Art.	Art.	Art.	Art.	Art.	Art.
Ø 12 mm	Plain Liscio 	1130/1	1130/2	1130/5	1127/4	70/B/3	70/B/5

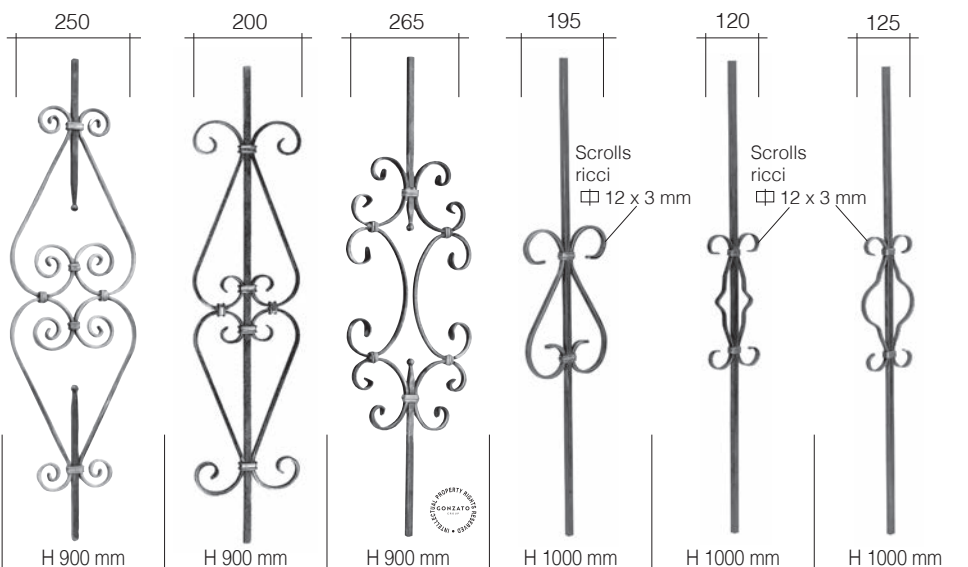

Sec.Sez.	Finish - Finitura	Art.	Art.	Art.	Art.	Art.	Art.
Ø 12 mm	Plain Liscio 	49/1	584/B/4	584/3	1128/2	1128/3	1128/5



Art. 584/A/2
Ø 12 x 12 mm
180 x 900 mm



Art. 584/A/3
Ø 12 x 12 mm
180 x 900 mm

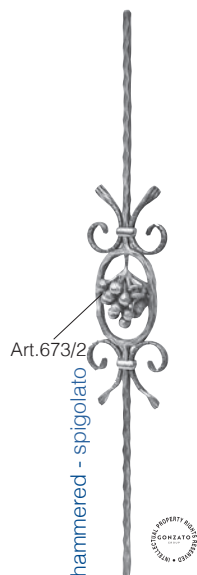

Art. 570/1
Ø 12 x 12 mm
140 x 900 mm



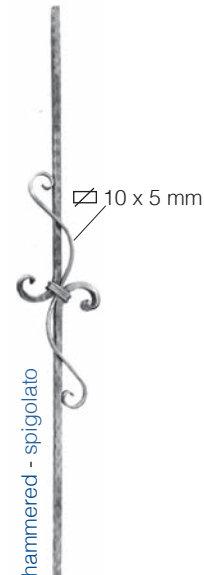

Art. 70/A/3
Ø 12 x 12 mm
130 x 1200 mm

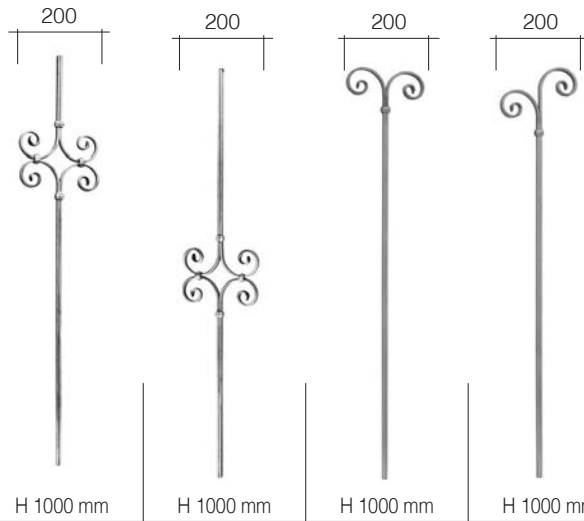

Art. 49/4
Ø 12 x 12 mm
125 x 900 mm



Sec.Sez.	Finish - Finitura	Art.	Art.	Art.	Art.
∅ 12 mm	Grooved Rigato  	1695/11	1695/12	1695/7	1695/8



Art. 1122/3
∅ 12 x 12 mm
180 x 1000 mm





Art. 1122/2
∅ 12 x 12 mm
140 x 1000 mm

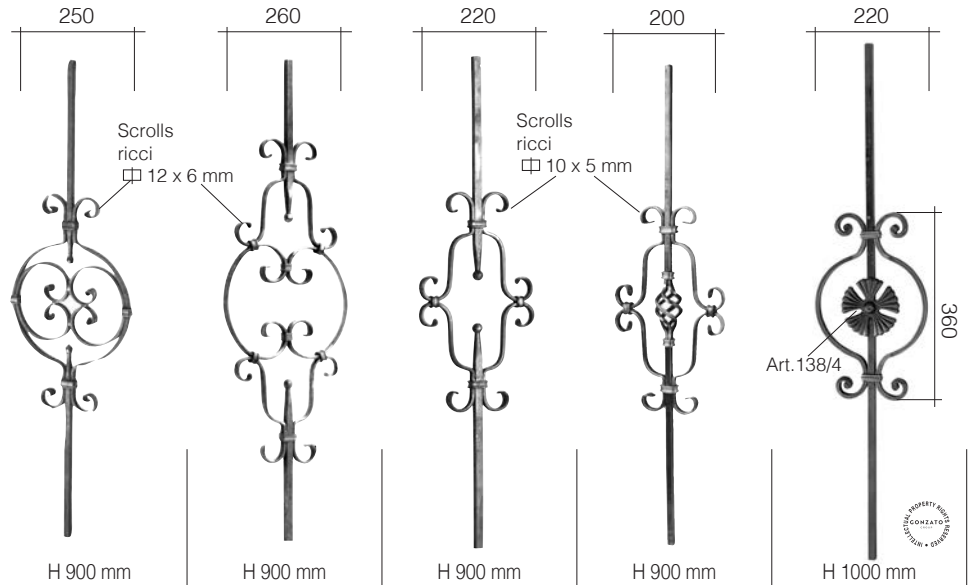

Art. 1122/1
∅ 12 x 12 mm
140 x 1000 mm



Sec.Sez.	Finish - Finitura	Art.	Art.	Art.	Art.	Art.
∅ 12 mm	Plain Liscio 	64/A/1	64/A/2	64/A/4	64/B/1	-
∅ 14 mm	Plain Liscio 	-	64/A/6	-	64/B/4	1126/2

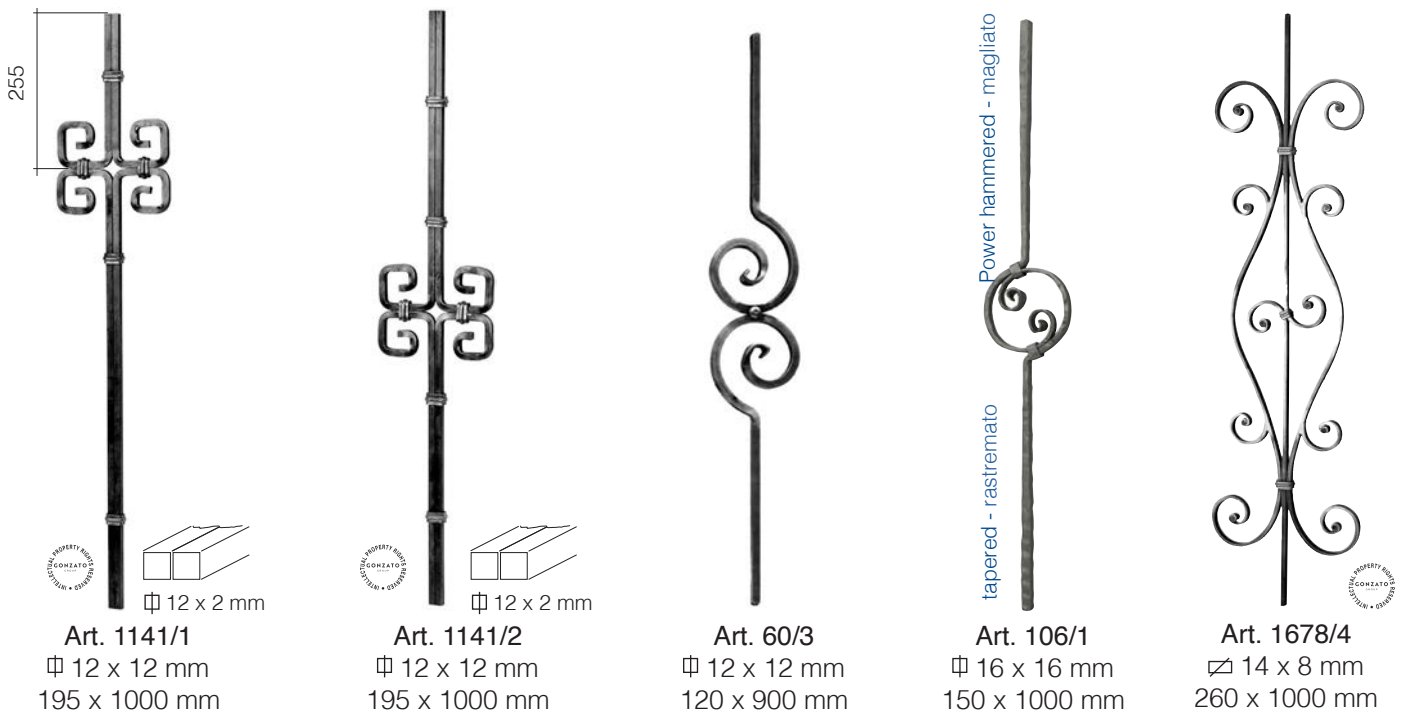

hammered - spigolato



Art. 479/1
Ø 12 x 12 mm
110 x 900 mm

plain - liscio



Art. 1641/3
Ø 12 x 12 mm
110 x 900 mm
Art. 1641/4
Ø 14 x 14 mm
110 x 900 mm

plain - liscio



Art. 1657/2
Ø 16 x 8 mm
110 x 1000 mm

plain - liscio



Art. 1657/3
Ø 16 x 8 mm
110 x 1000 mm





Art. 1032/1
Ø 12 x 12 mm
190 x 1000 mm

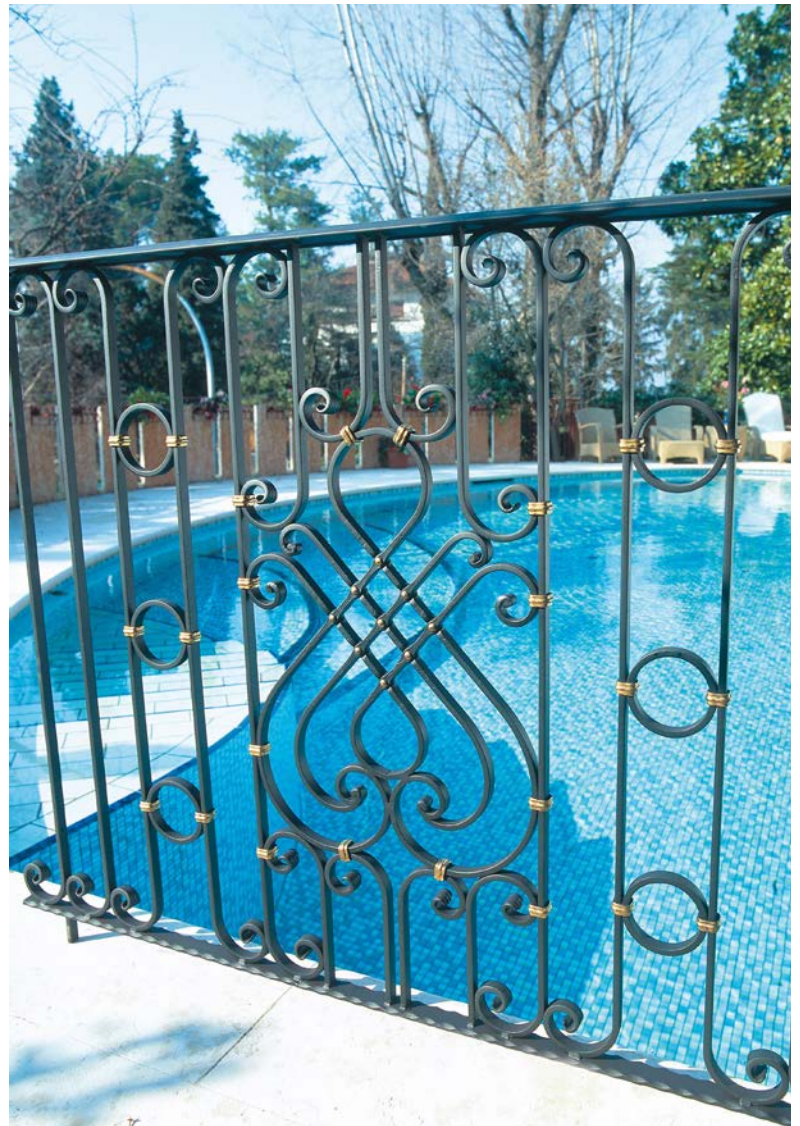

Art. 1043/1
Ø 12 x 12 mm
210 x 1000 mm

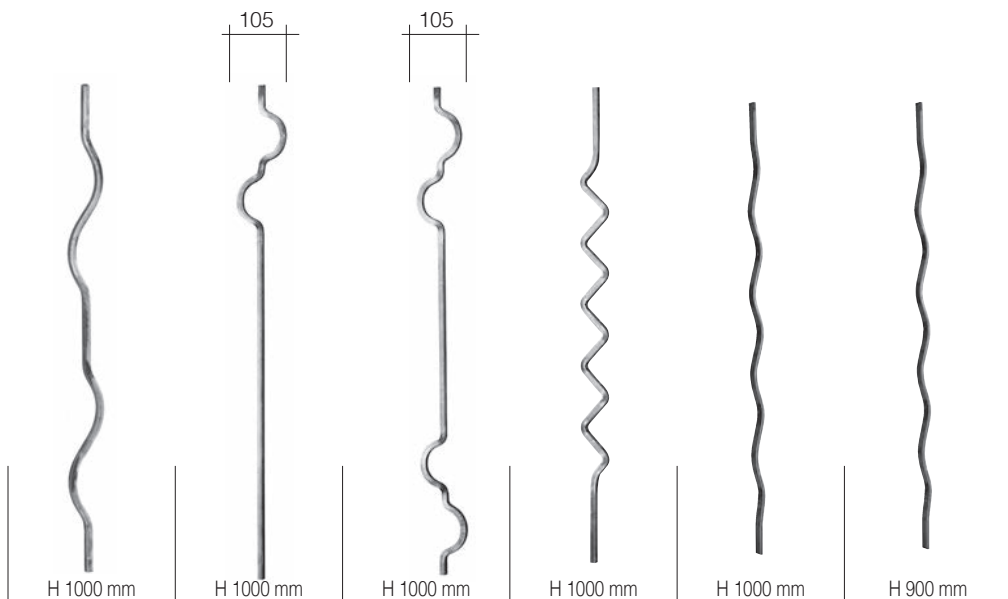



Sec.Sez.	Finish - Finitura	Art.	Art.	Art.	Art.	Art.	Art.
∅ 12 mm	Plain Liscio 	134/G/4	1115/1	1115/2	1133/25	-	-
∅ 14 mm	Plain Liscio 	-	-	-	-	597/4	70/D/1



Art. 1056/10

Art. 1056/10
Fast installation by just a small welding, thanks to a cut off on the edge

Art. 1056/10
Installazione veloce con una piccola saldatura, grazie alla sezione troncata



NEW



Art. 1056/10
∅ 12 x 12 mm
125 x 1000 mm

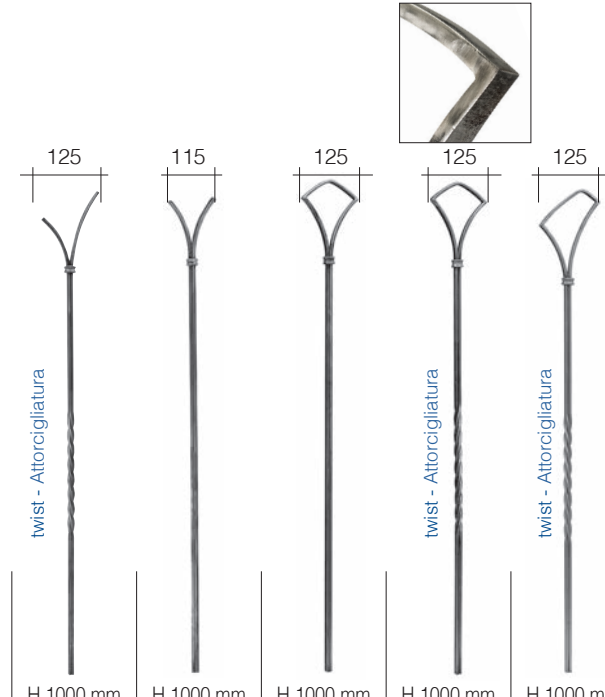

twist - Attorcigliatura

twist - Attorcigliatura

twist - Attorcigliatura

twist - Attorcigliatura

twist - Attorcigliatura

Sec.Sez.	Finish - Finitura	Art.	Art.	Art.	Art.	Art.
∅ 12 mm	Grooved Rigato 	1055/4	1055/5	1056/1	1056/2	1056/4

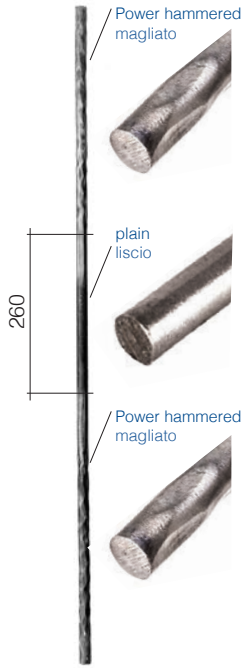

Art. 595/12
Ø 12 mm
H 900 mm



Art. 602/15
Ø 14 mm
H 1200 mm
Art. 602/18
Ø 20 mm
H 1200 mm

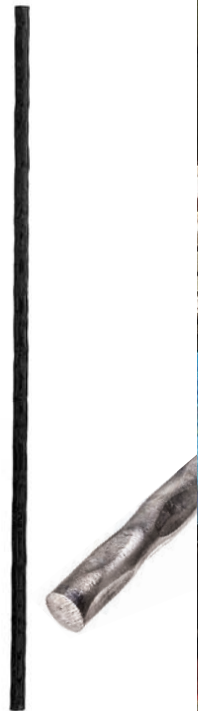

Art. 601/2
Ø 12 mm
H 900 mm
Art. 601/10
Ø 16 mm
H 1000 mm



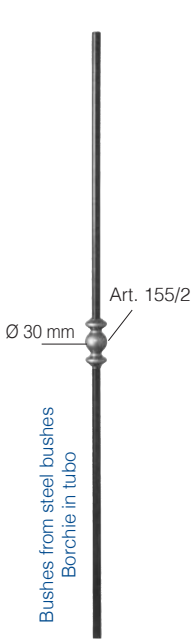

Art. 150/3
Ø 12 mm
H 900 mm

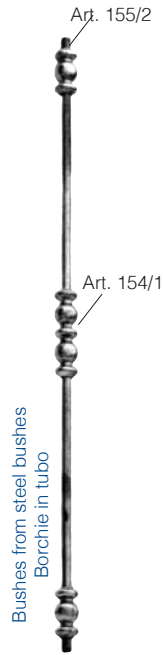

Art. 154/6
Ø 12 mm
H 830 mm

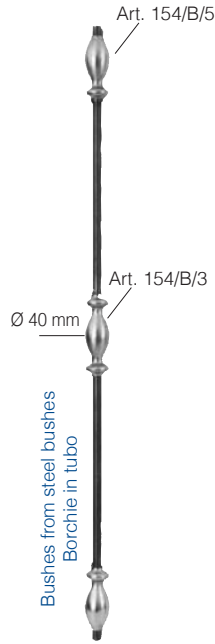

Art. 154/B/7
Ø 14 mm
H 720 mm

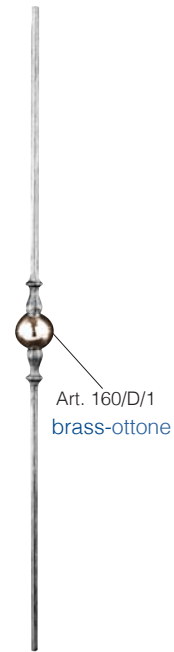

Art. 518/1
H 900 mm

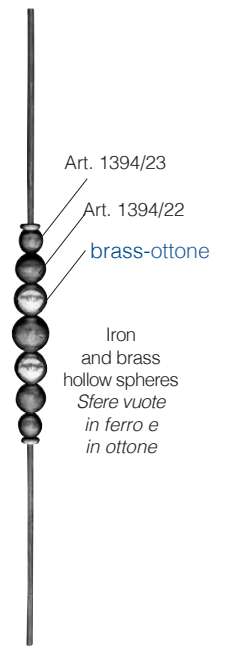

Art. 1211/4
Ø 12 mm
H 1000 mm



Art. 570/4
Ø 14 x 14 mm
100 x 900 mm



Art. 1067/2
Ø 12 mm
H 1000 mm



Art. 1067/3
Ø 12 mm
175 x 1000 mm



Art. 160/C/1
Ø 20 x 20 mm
130 x 900 mm



Art. 61/3
plain/liscio
Ø 40 x 4 mm
125 x 900 mm



Art. 1081/4
Ø 10 mm
220 x 1000 mm



Art. 1080/7
Ø 12 mm
124 x 1000 mm

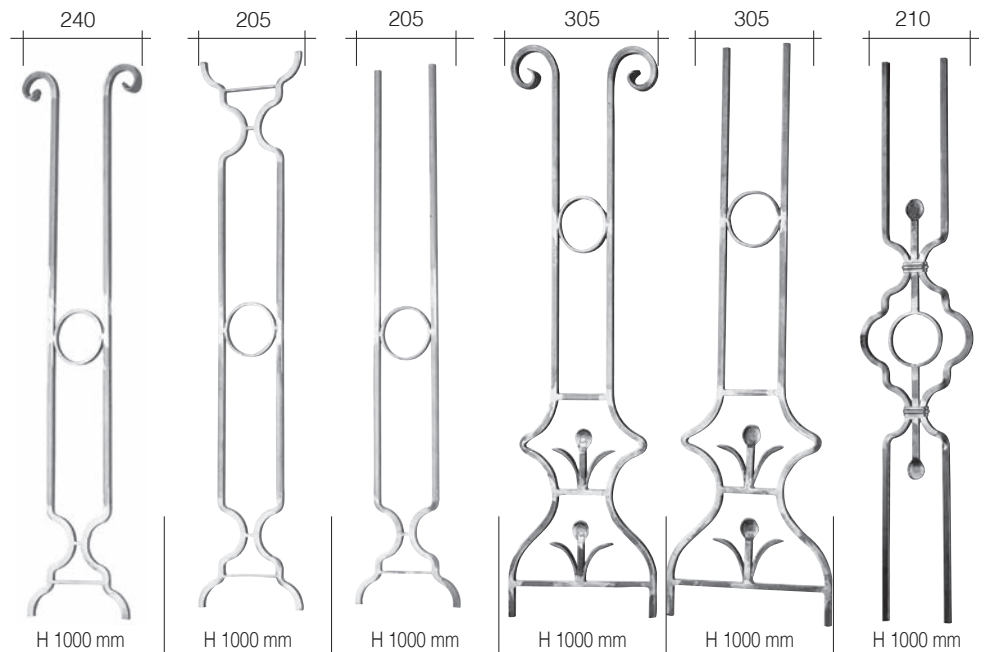
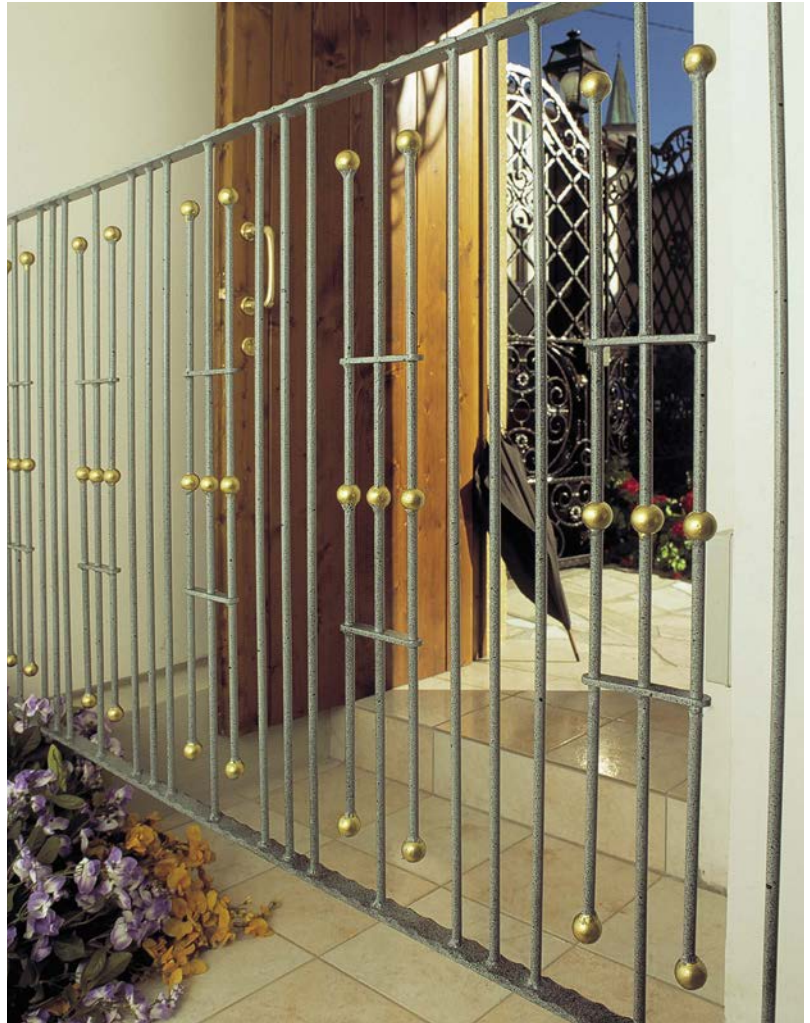

Sec.Sez.	Finish - Finitura	Art.	Art.	Art.	Art.	Art.	Art.
Ø 12 mm	Plain Liscio 	1111/1	1111/2	1111/3	1097/1	1097/2	1105/1



Art. 1142/1
 \varnothing 12 x 12 mm
 180 x 1000 mm



Art. 1142/2
 \varnothing 12 x 12 mm
 280 x 1000 mm



Art. 1741/3
 \varnothing 12 x 12 mm
 280 x 1000 mm

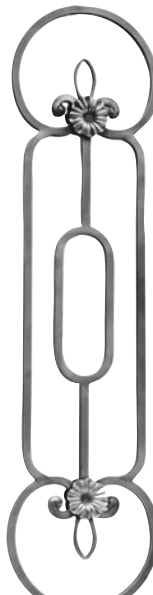

Rosette | 1/6/A/4 sui due lati - Rosettes | 1/6/A/4 on both sides



Art. 1685/1
 \varnothing 14 x 14 mm
 245 x 1000 mm

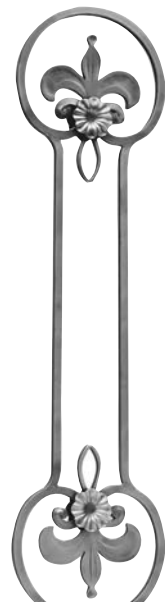

Rosette | 1/6/A/4 sui due lati - Rosettes | 1/6/A/4 on both sides



Art. 1685/2
 \varnothing 14 x 14 mm
 245 x 1000 mm



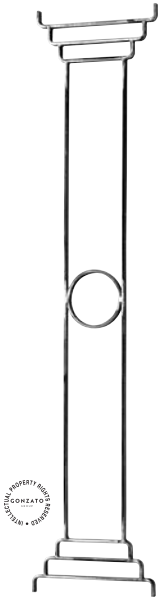

Art. 1118/1
12 x 6 mm
215 x 1000 mm



Art. 1672/1
14 x 8 mm
175 x 1000 mm

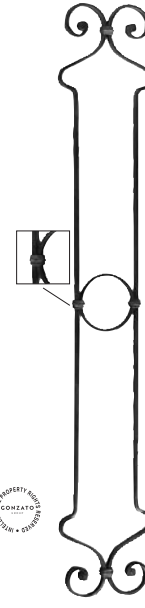

Art. 1672/2
14 x 8 mm
175 x 1000 mm

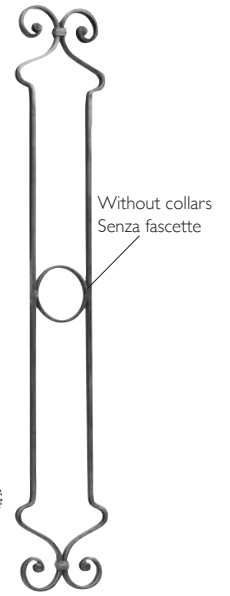

Art. 1674/2
14 x 8 mm
175 x 1000 mm



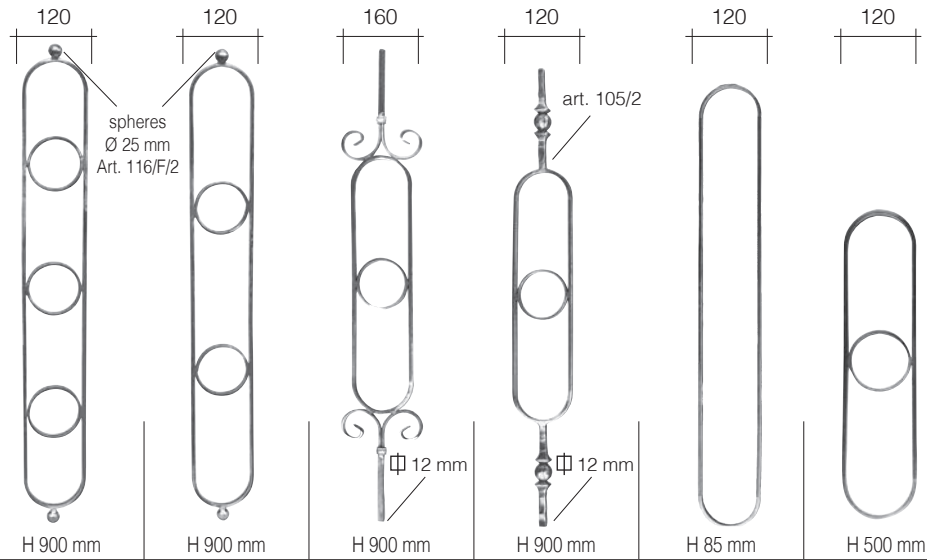

Sec.Sez.	Finish - Finitura	Art.	Art.	Art.	Art.	Art.	Art.
Ø 14 x 8 mm	Plain Liscio	544/1	544/2	548/2	555/1	543/1	543/3

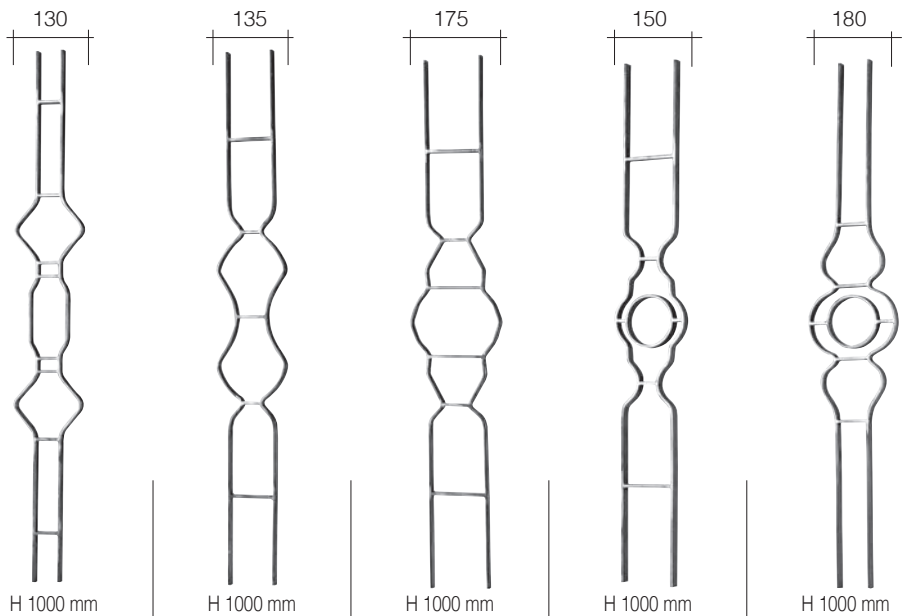

Sec.Sez.	Finish - Finitura	Art.	Art.	Art.	Art.	Art.
Ø 20 x 6 mm	Plain Liscio	1117/1	1117/2	1117/3	1116/3	1116/4



Art. 1116/1
Ø 20 x 8 mm
265 x 1000 mm



Art. 1116/2
Ø 20 x 8 mm
245 x 1000 mm



Art. 1101/1
Ø 20 x 8 mm
240 x 1000 mm



Art. 670/4
Ø 12 mm
320 x 520 mm



Art. 673/2
Ø 12 mm
300 x 500 mm



Art. 671/1
Ø 12 mm
315 x 390 mm



Art. 671/2
Ø 12 mm
315 x 390 mm



Art. 671/3
Ø 12 mm
420 x 490 mm



Art. 671/4
Ø 12 mm
420 x 490 mm



Art. 678/1
Ø 12 mm
75 x 510 mm

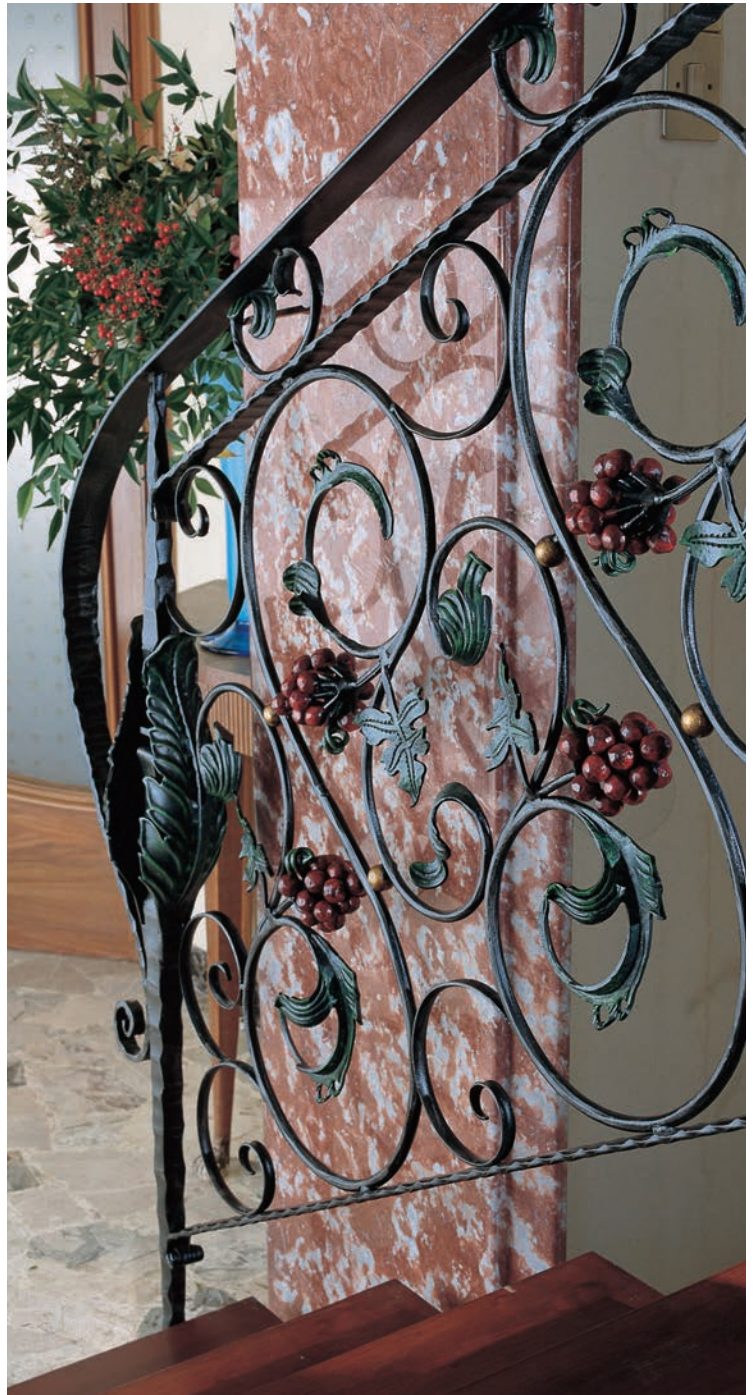

* Scrolls with forged ends - Riccioli con terminali fucinati

Rosettes 126/3 on both sides
Rosette 126/3 sui 2 lati



Art. 24/F/1
Φ 12 x 12 mm
300 x 560 mm



Art. 1050/4
Ø 12 mm
265 x 640 mm



Art. 1050/3
Φ 14 x 14 mm
265 x 720 mm



Art. 540/2
Ø 12 mm
250 x 720 mm



Art. 62/1
∅ 20 x 6 mm
235 x 720 mm
Art. 1050/1
∅ 20 x 6 mm
235 x 720 mm



Art. 62/2
∅ 20 x 6 mm
235 x 720 mm



Art. 63/4
∅ 20 x 6 mm
235 x 820 mm



Art. 1045/7
Φ 12 x 12 mm
250 x 770 mm



Art. 1045/8
Φ 12 x 12 mm
250 x 770 mm



Art. 1045/5
Φ 12 x 12 mm
250 x 770 mm



Art. 1045/6
Φ 12 x 12 mm
250 x 770 mm



Art. 1050/2
Φ 10 x 10 mm
235 x 720 mm



Art. 63/2
∅ 20 x 6 mm
235 x 720 mm



Art. 63/3
∅ 20 x 4 mm
235 x 820 mm



Art. 1046/1
Φ 12 x 12 mm
250 x 900 mm



Art. 1046/2
Φ 12 x 12 mm
200 x 900 mm



Art. 1051/4
Ø 12 x 6 mm
150 x 400 mm
Plain - Liscio



Art. 1671/6
Ø 12 x 6 mm
190 x 435 mm
Plain - Liscio



Art. 1051/5
Ø 12 x 6 mm
185 x 600 mm
Plain - Liscio



Art. 52/1
Ø 12 x 6 mm
350 x 870 mm
Plain - Liscio



* Art. 1670/1
Ø 12 x 6 mm
360 x 1000 mm
Plain - Liscio



* Art. 1670/2
Ø 12 x 6 mm
350 x 870 mm
Plain - Liscio

Pag.
336

Do you need wrought
iron leaves?
Go to section 15
Flowers and Rosettes

Hai bisogno di foglie
in ferro battuto?
Vai al capitolo 15
Fiori e Rosette

*Rosettes 116/A/4 on both sides
*Rosette 116/A/4 sui 2 lati

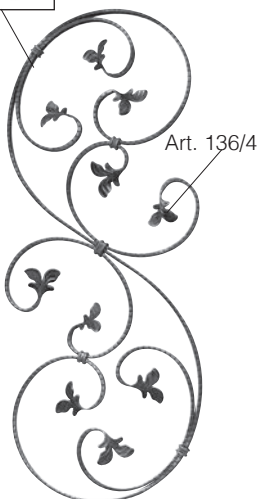

Art. 1671/3
Ø 12 x 6 mm
350 x 870 mm
Notched - Tacchettato



Art. 1671/4
Ø 12 x 6 mm
350 x 870 mm
Hammered - Spigolato



Art. 541/1
Ø 12 x 12 mm
370 x 900 mm
Hammered - Spigolato



Art. 1671/1
Ø 12 x 12 mm
350 x 900 mm
Hammered - Spigolato

Art. 541/2
Ø 14 mm
340 x 900 mm
Plain - Liscio

Art. 1671/2
Ø 12 mm
350 x 900 mm
Plain - Liscio

Hot forged end scrolls - Riccioli terminali fucinati a caldo



Art. 681/2
 \square 16 x 8 mm
 270 x 600 mm



Art. 681/1
 \square 16 x 8 mm
 270 x 600 mm



Art. 685/4
 \varnothing 12 mm
 240 x 590 mm



Art. 685/3
 \varnothing 12 mm
 240 x 590 mm



Art. 685/2
 \varnothing 12 mm
 320 x 740 mm



Art. 685/1
 \varnothing 12 mm
 320 x 740 mm



Art. 681/3
 \square 16 x 8 mm
 320 x 740 mm



Art. 681/4
 \square 16 x 8 mm
 320 x 740 mm



Art. 682/5
 right-*destra*
 \square 16 x 8 mm
 300 x 580 mm

Art. 682/4
 left-*sinistra*
 \square 16 x 8 mm
 300 x 580 mm



Art. 685/6
 \varnothing 12 mm
 360 x 810 mm



Art. 685/5
 \varnothing 12 mm
 360 x 810 mm

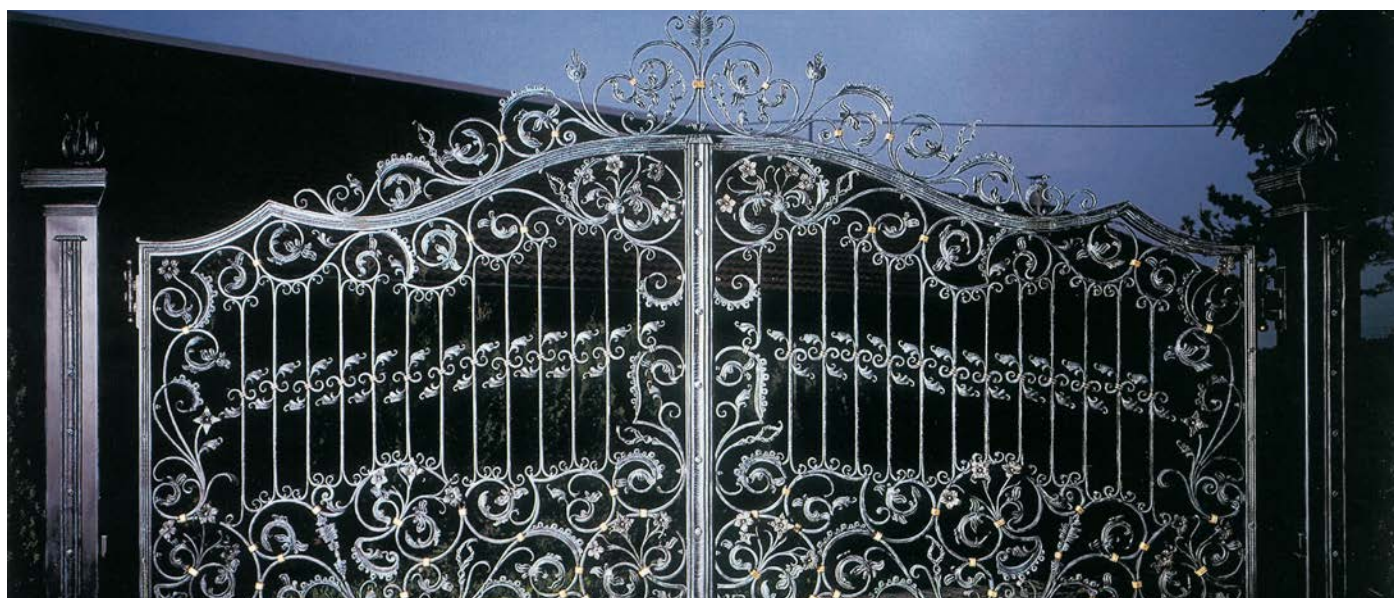



Art. 486/2
16 x 8 mm
300 x 700 mm



Forgiati/Hot forged

Art. 498/1
Ø 12 mm
H 650 mm

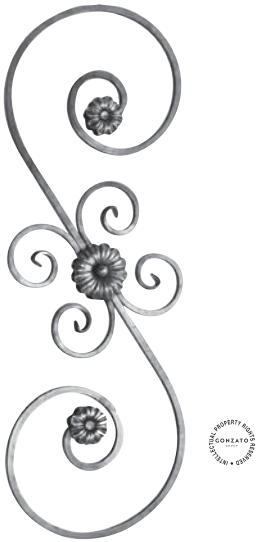

Art. 52/E/5
12 x 12 mm
300 x 900 mm

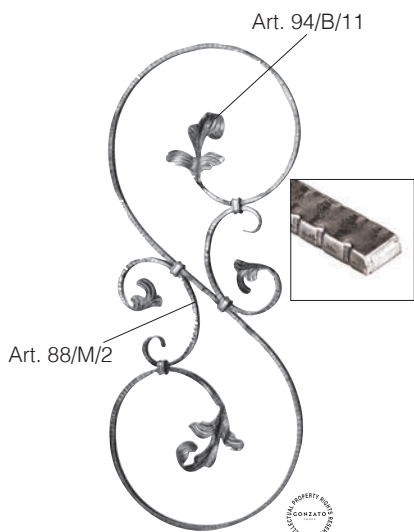

Art. 52/G/1
16 x 8 mm
370 x 870 mm
Notched
Tacchettato



Art. 485/1
Ø 10 mm
370 x 900 mm



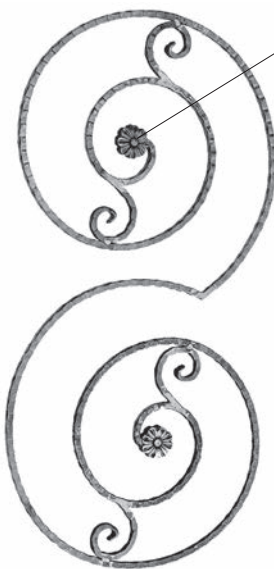

Art. 483/1
 Φ 14 x 14 mm
 540 x 1100 mm
 power hammered
 magliato



Art. 697/4 on
both sides
Art. 697/4 su
entrambi i lati

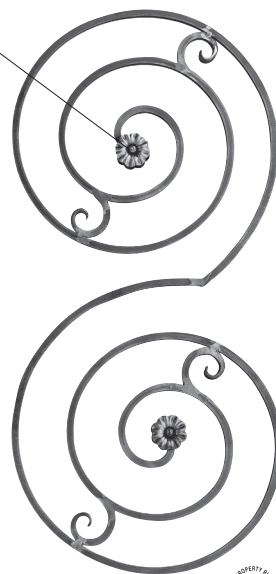

Art. 1038/1
 Φ 14 x 14 mm
 510 x 1080 mm
 plain - liscio



Art. 1206/1
 Φ 30 x 30 mm
 H 1200 mm
 L 270 mm

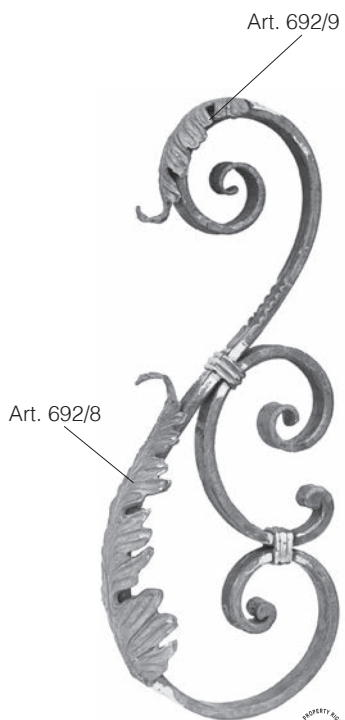

Art. 802/2
 \square 25 x 12 mm
 H 650 mm
 L 270 mm





Art. 1049/1
Ø 14 mm
260 x 1000 mm

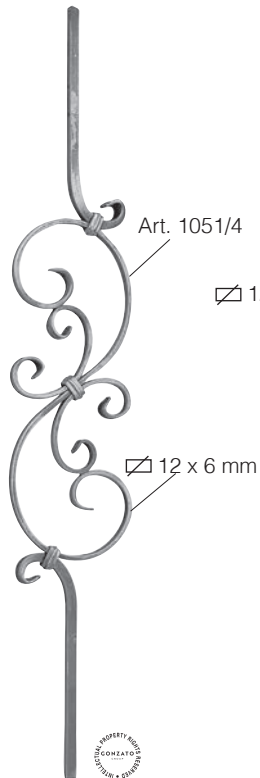

Art. 1051/2
Ø 12 x 12 mm
150 x 1000 mm



Art. 1051/3
Ø 12 x 12 mm
150 x 1000 mm



Art. 52/E/1
Ø 12 x 12 mm
180 x 900 mm
hammered - spigolato



Art. 52/A/4
Ø 12 x 12 mm
250 x 900 mm



Art. 1051/1
Ø 12 x 12 mm
185 x 1000 mm



Art. 659/10



Hollow spheres - Sfere vuote
Ø 30 mm - Ø 40 mm



Art. 1064/3
Ø 12 mm
200 x 1000 mm

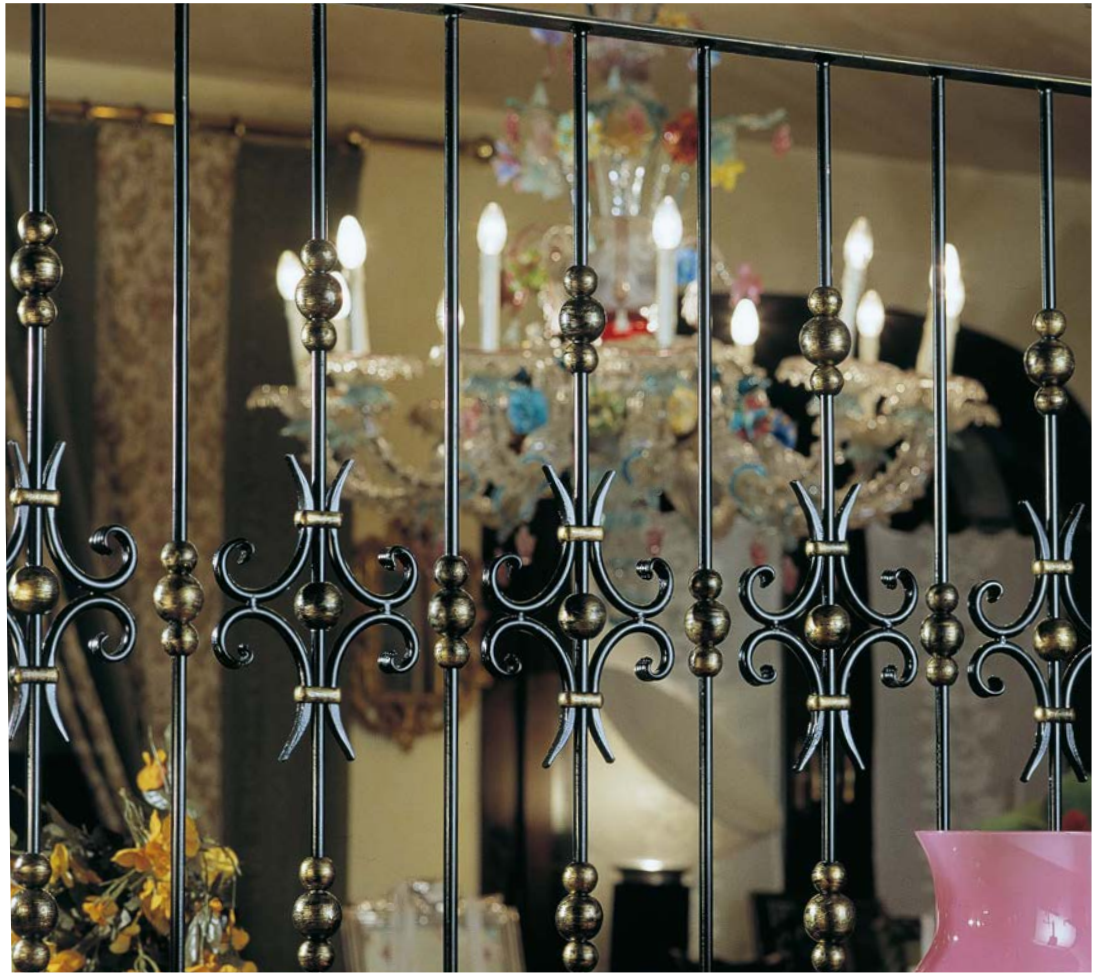

Art. 138/15

Art. 49/2
Ø 12 x 12 mm
165 x 900 mm
hammered - spigolato



Art. 539/2
Ø 12 x 12 mm
190 x 900 mm

676/2 on both sides - sui 2 lati



Art. 487/1
Ø 16 x 8 mm
230 x 900 mm



Art. 488/1
Ø 16 x 8 mm
190 x 900 mm

Rosette 116/A/4 on both sides - sui 2 lati



Art. 1678/2
Ø 14 x 8 mm
205 x 1000 mm



Art. 51/3
 \varnothing 12 x 12 mm
 300 x 900 mm

Art. 51/6
 \varnothing 14 x 14 mm
 300 x 900 mm

Art. 1753/4
 \varnothing 12 x 12 mm
 300 x 1000 mm

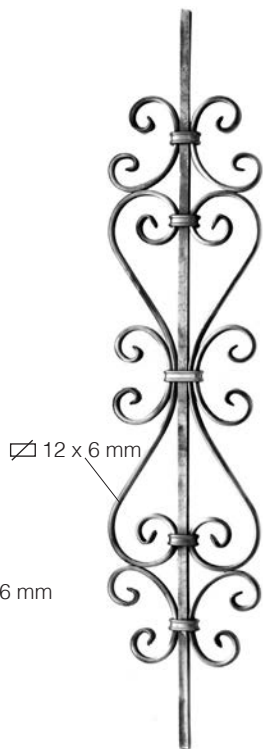

Art. 52/E/2
 \varnothing 12 x 12 mm
 185 x 900 mm



Art. 510/1
 \varnothing 12 x 12 mm
 250 x 900 mm



Art. 511/1
 \varnothing 12 x 12 mm
 125 x 900 mm





Art. 68/2
Ø 8 x 8 mm
250 x 720 mm



Art. 58/1
Ø 8 x 8 mm
270 x 800 mm

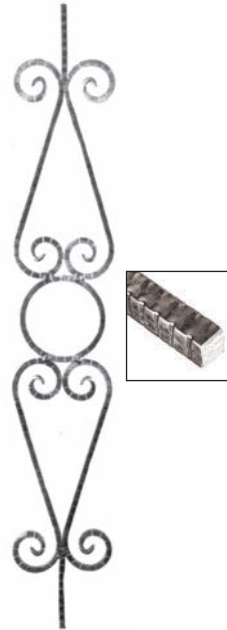

Art. 64/2
Ø 8 x 8 mm
140 x 850 mm



Art. 471/1
Ø 14 x 8 mm
250 x 900 mm

Pag.
276

In section 11,
scrolls and Snap-ons
you'll find many items
to match

Nel capitolo 11
Ricci e Snap-ons
troverai tanti
elementi da abbinare



Art. 453/8
Ø 12 x 6 mm
180 x 480 mm

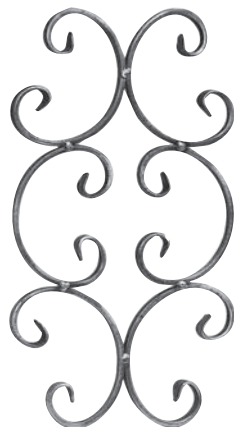

Art. 453/9
Ø 12 x 6 mm
220 x 405 mm



Art. 59/1
Ø 20 x 4 mm
170 x 830 mm



Art. 59/8
Ø 20 x 4 mm
175 x 820 mm



Art. 59/3
Ø 20 x 4 mm
175 x 720 mm



Art. 64/B/3
Ø 12 x 12 mm
255 x 900 mm



Art. 65/1
Ø 12 x 12 mm
160 x 820 mm



Art. 70/E/2
Ø 12 x 12 mm
H 820 mm



Art. 70/E/7
Ø 14 x 14 mm
H 820 mm

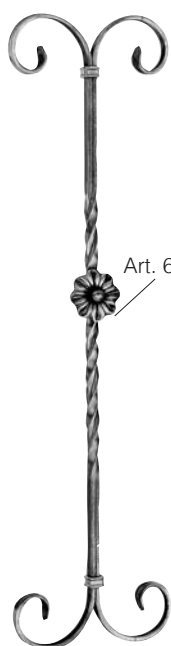

Art. 463/3
12 x 6 mm
210 x 790 mm

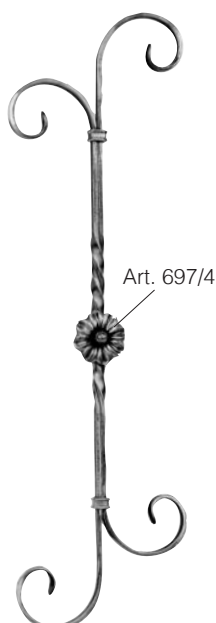

Art. 463/4
12 x 6 mm
210 x 660 mm



Art. 464/1
12 x 12 mm
230 x 900 mm

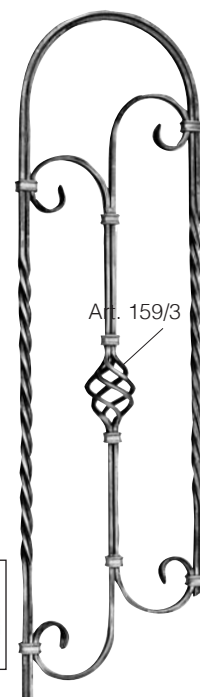

Art. 464/2
12 x 12 mm
230 x 900 mm

Rosette 116/A/4 on both sides - sui 2 lati



Art. 473/1
 ⌀ 12 x 12 mm
 380 x 900 mm
 hammered - spigolato



Art. 474/1
 ⌀ 12 x 12 mm
 380 x 755 mm
 hammered - spigolato

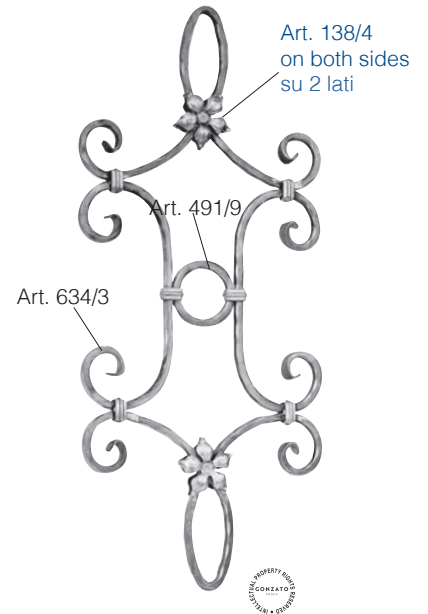

Art. 479/2
 ⌀ 12 x 12 mm
 385 x 900 mm
 hammered - spigolato

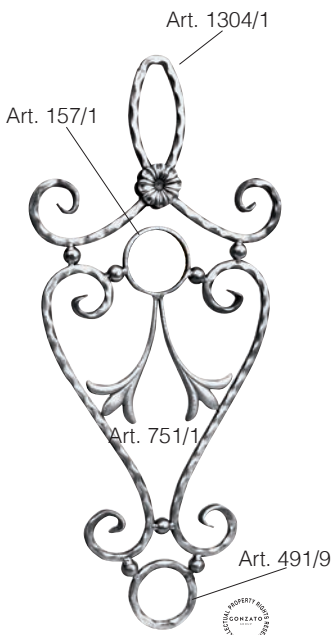

Art. 475/1
 ⌀ 12 x 12 mm
 380 x 825 mm
 hammered - spigolato

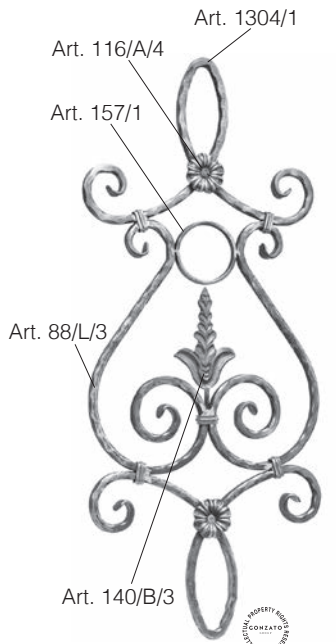

Art. 475/2
 ⌀ 12 x 12 mm
 380 x 900 mm
 hammered - spigolato



Art. 1647/2
 □ 12 x 6 mm
 200 x 500 mm



Art. 1647/3
 □ 12 x 6 mm
 200 x 500 mm

Rosette 116/A/4 on both sides - sui 2 lati





Art. 456/1
Ø 12 x 12 mm
400 x 1020 mm

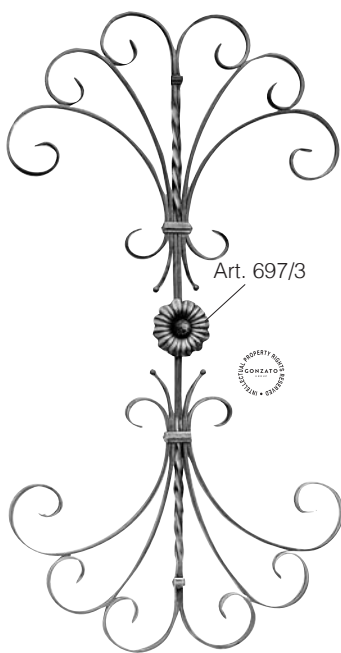

Art. 456/3
Ø 12 x 6 mm
454 x 1020 mm



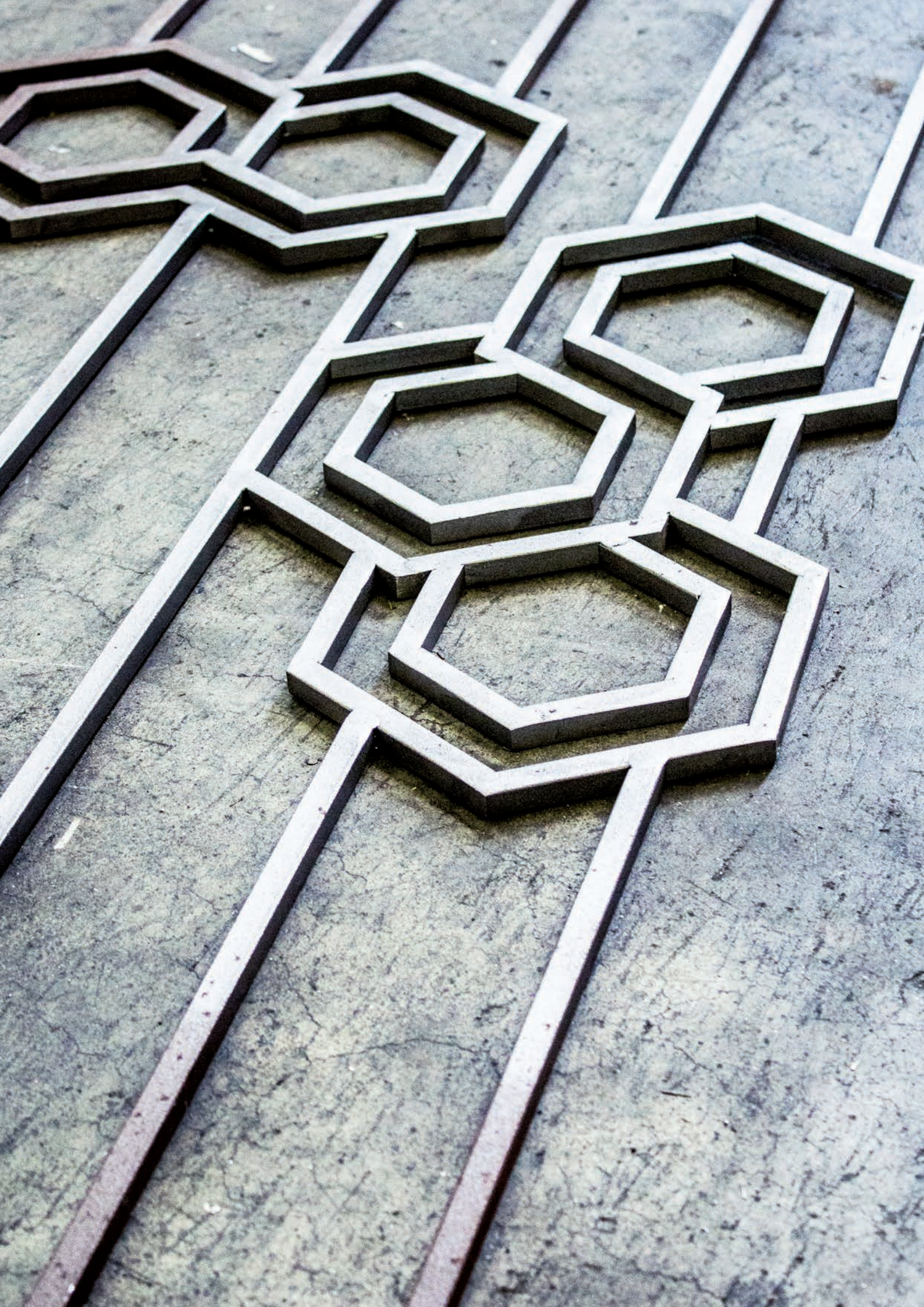

Modern Pickets and Panels

Paletti e Pannelli moderni

Arteferro pickets and panels are amongst the most important items in the composition of an infill of a balustrade or fence. The modern design of these new lines of items reinterprets in a contemporary way, the elegance and refinement of traditional materials like wrought iron.

I paletti e pannelli Arteferro sono tra gli elementi più importanti nella composizione del tamponamento di un parapetto o di una recinzione. Il design moderno di queste nuove linee di elementi reinterpreta in chiave contemporanea l'eleganza e la raffinatezza di un materiale tradizionale come il ferro battuto.

arteferro



5

Modern pickets and Panels
Paletti e Pannelli moderni



- A Geometric Style pag.158
- B Linear Style pag.168
- C Floreal Style pag.180
- D Waves Style pag.185
- E Impero Style pag.189
- F Revolution Style pag.194
- G New Classic Style pag.201
- H New Liberty Style pag.210

Most of the pickets and panels have been classified to make it easier for you to find the item you want quickly and easily. Starting with the central motif you can find your article with its finish and the matching decorations.

Molti paletti e pannelli sono stati classificati per dare la possibilità di trovare in modo veloce e pratico l'articolo desiderato. Parti dal motivo centrale troverai il tuo articolo con la lavorazione e i decori abbinabili.



Art. 1082/4
Ø 10 mm
100 x 1000 mm



Art. 1085/1
Ø 12 mm
112 x 1000 mm



Art. 1085/2
Ø 12 mm
112 x 1000 mm



Art. 1084/1
Ø 12 x 12 mm
175 x 1000 mm



Art. 1084/2
Ø 12 x 12 mm
175 x 1000 mm

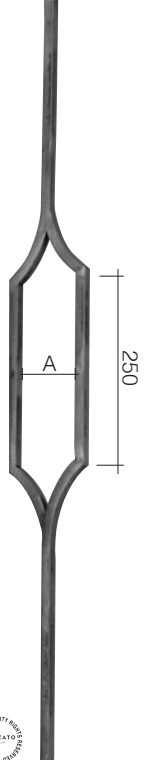
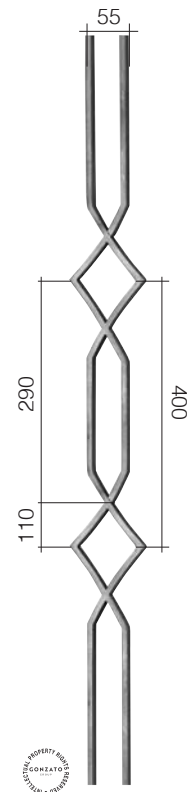
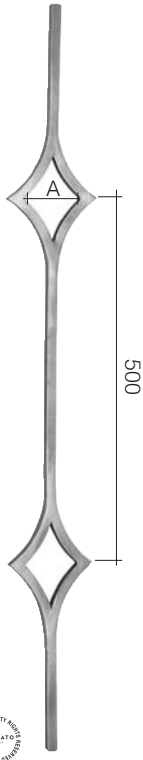

Art. GD59/2
 \varnothing 12 x 12 mm
 55 x 1000 mm
 Art. GD59/2/Q14
 \varnothing 14 x 14 mm
 55 x 1000 mm

Art. GD23/1
 \varnothing 14 mm
 120 x 1000 mm
 A = 75 mm
 Art. GD58/3
 \varnothing 12 mm
 120 x 1000 mm
 A = 80 mm

Art. GD25/1
 \varnothing 14 mm
 120 x 1000 mm
 A = 75 mm
 Art. GD58/2
 \varnothing 12 mm
 120 x 1000 mm
 A = 80 mm

Art. GD19/1
 \varnothing 14 x 8 mm
 100 x 1000 mm

Art. GD19/2
 \varnothing 14 x 8 mm
 100 x 1000 mm

Art. GD25/3
 \varnothing 14 mm
 110 x 1000 mm
 A = 82 mm
 Art. GD243/2
 \varnothing 12 mm
 110 x 1000 mm
 A = 86 mm



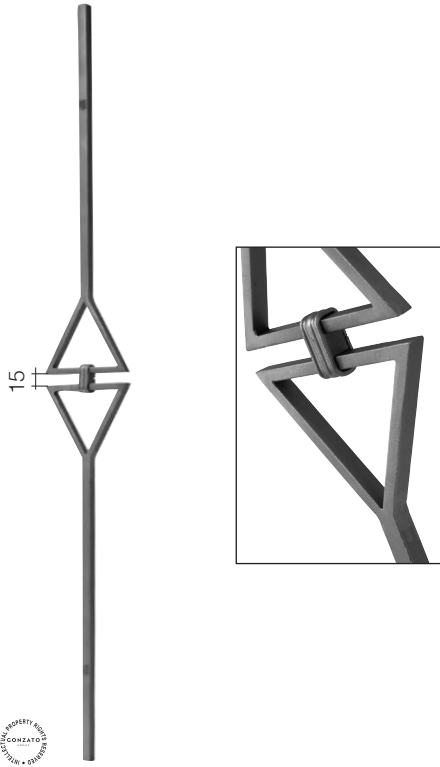

Art. GD181/1
 \square 14 mm
 130 x 1000 mm

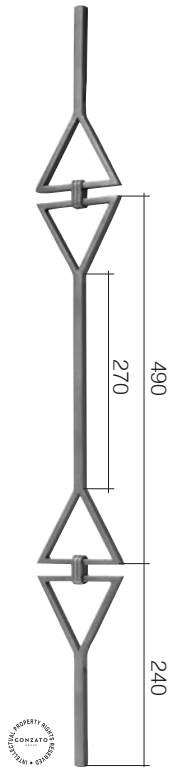

Art. GD181/2
 \square 14 mm
 130 x 1000 mm

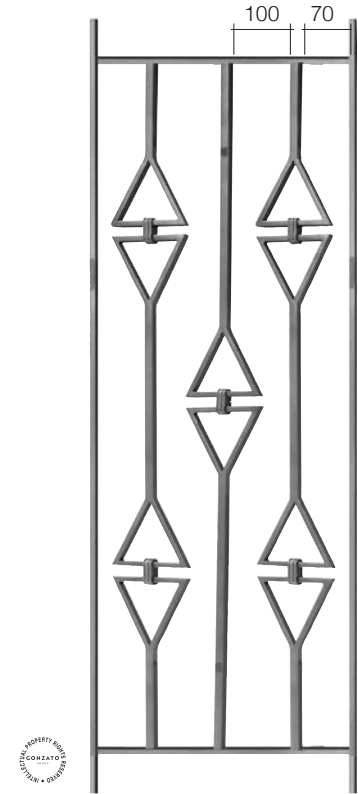

Art. GD181/3
 \square 14 x 8 mm
 400 x 1000 mm

Ornaments - Ornamenti \square 14 x 8 mm

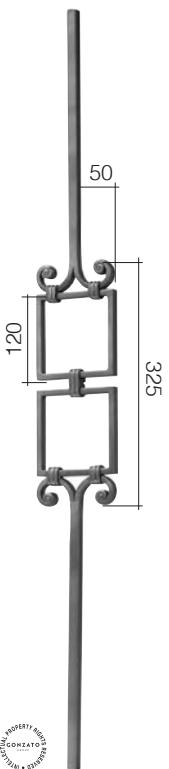

Art. GD184/1
 \square 14 mm
 115 x 1000 mm

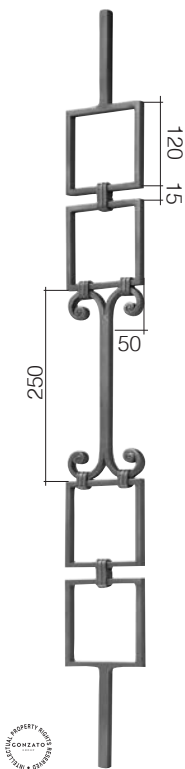

Art. GD184/2
 \square 14 mm
 115 x 1000 mm

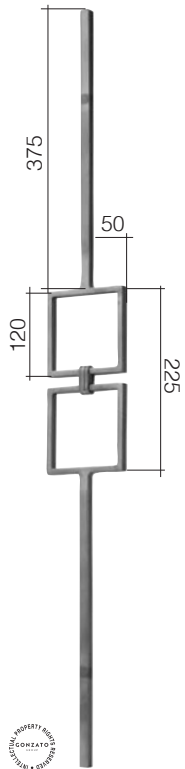

Art. GD182/1
 \square 14 mm
 115 x 1000 mm

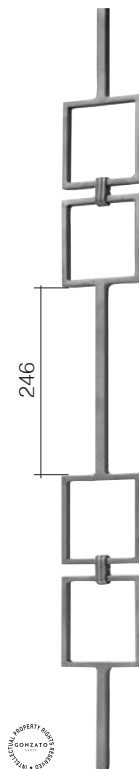

Art. GD182/2
 \square 14 mm
 115 x 1000 mm

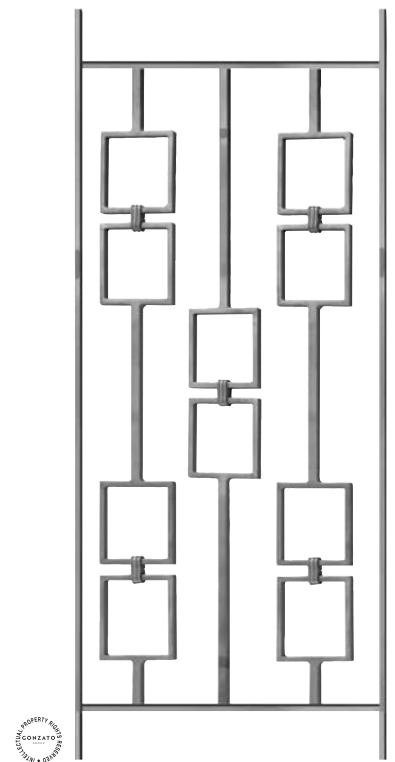

Art. GD183/1
 \square 14 x 8 mm
 400 x 1000 mm

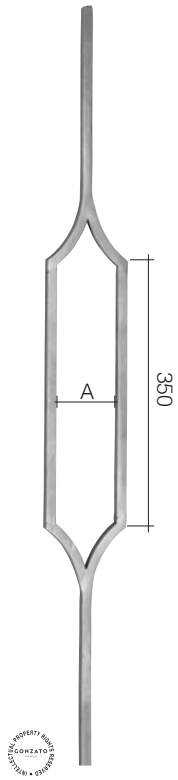

Art. GD25/2
 \varnothing 14 mm
 110 x 1000 mm
 A = 82 mm
 Art. GD243/1
 \varnothing 12 mm
 110 x 1000 mm
 A = 86 mm

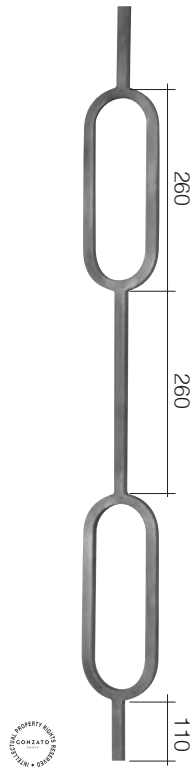

Art. GD29/2
 \varnothing 14 mm
 L 100 mm
 H 1000 mm

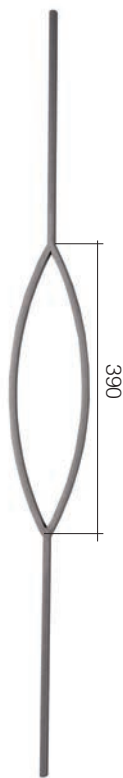

Art. GD278/1
 \varnothing 14 x 8 mm
 L 105 mm
 H 1000 mm



Art. GD278/2
 \varnothing 14 x 8 mm
 L 105 mm
 H 1000 mm

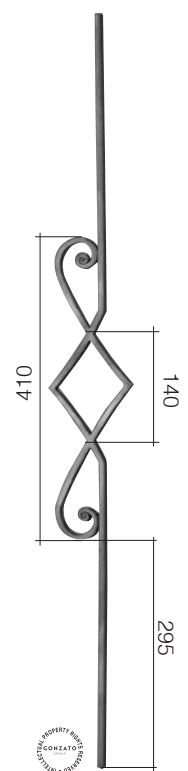

Art. GD19/4
 \varnothing 14 x 8 mm
 L 100 mm
 H 1000 mm



Art. GD305/1
 \varnothing 20 x 6 mm
 112 x 1016 mm



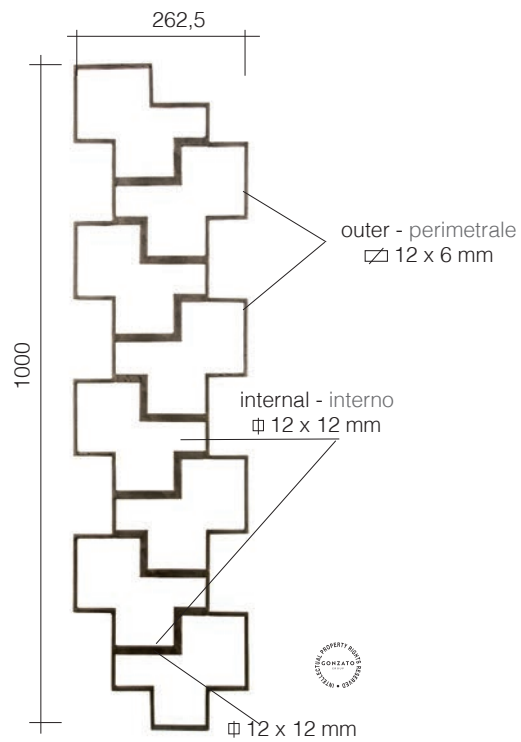

Art. GD293/1
12 x 6 mm + 12 mm
262,5 x 1000 mm



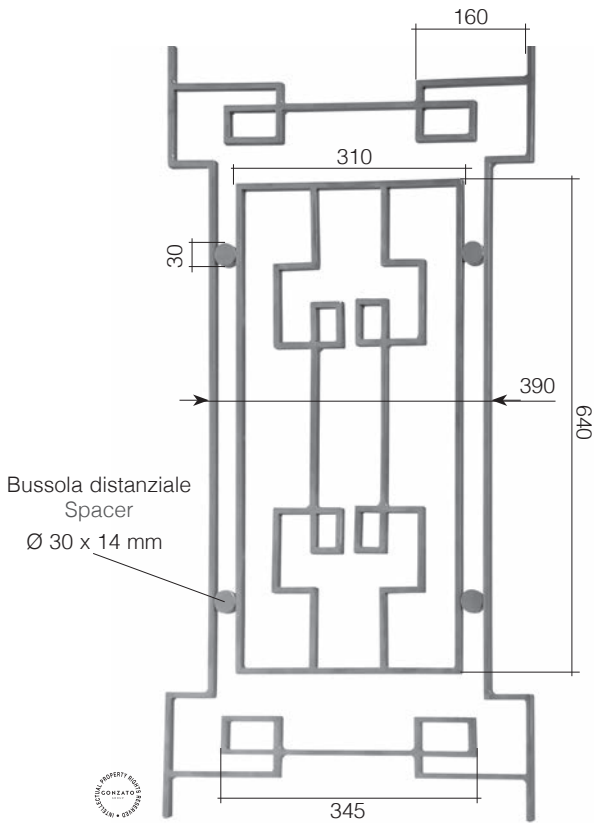

Art. GD202/1
 □ 14 x 8 mm
 L 500 mm
 H 1000 mm

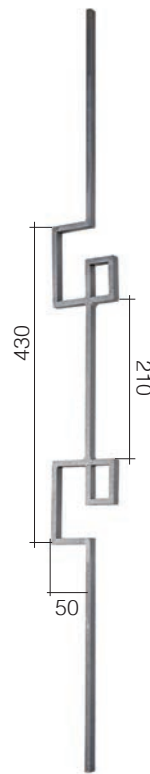

Art. GD202/2
 □ 14 x 8 mm
 L 95 mm
 H 1000 mm

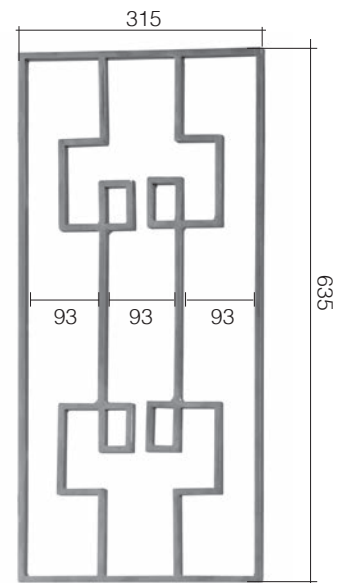

Art. GD202/4
 □ 14 x 8 mm
 L 315 mm
 H 635 mm



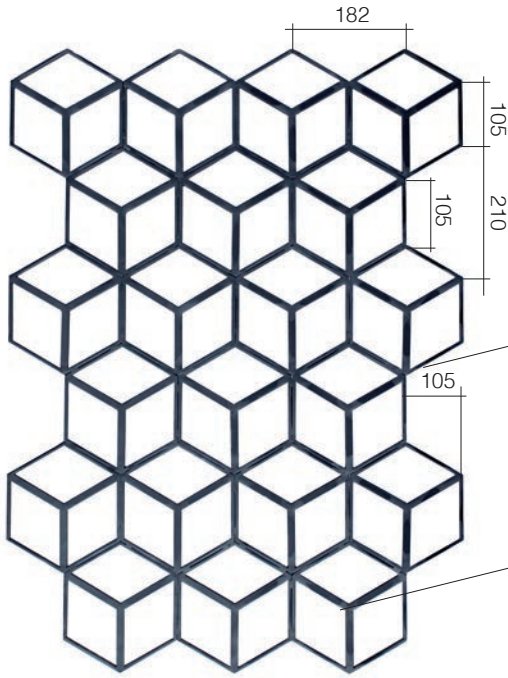

Art. GD287/1
 $\square 12 \times 6 \text{ mm} + \Phi 12 \text{ mm}$
 729 x 1000 mm

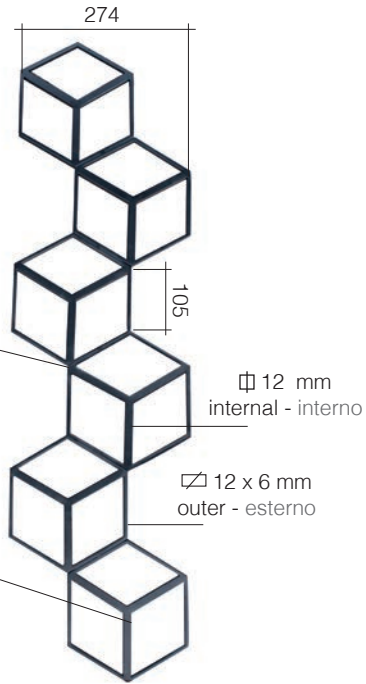

Art. GD287/2
 $\square 12 \times 6 \text{ mm} + \Phi 12 \text{ mm}$
 274 x 1000 mm

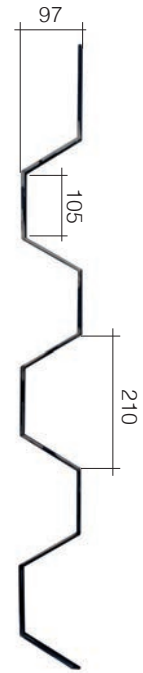

Art. GD287/3
 $\square 12 \times 6 \text{ mm}$
 H 1000 mm



**APPLICATION ON
STAIRCASE
ESEMPIO DI MONTAGGIO
SU SCALA**

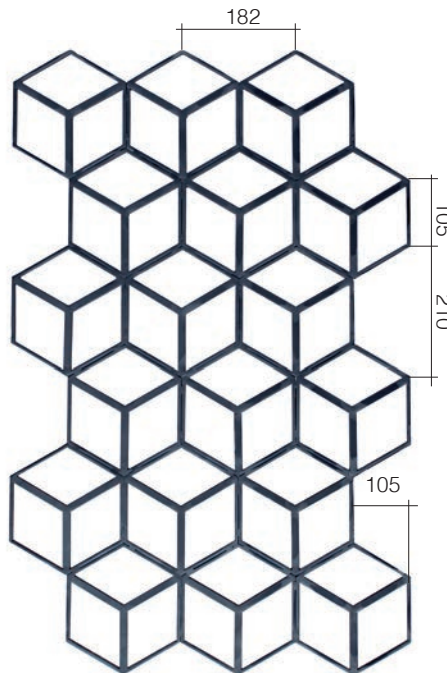

Art. GD287/4
 $\square 12 \times 6 \text{ mm} + \Phi 12 \text{ mm}$
 638 x 1000 mm

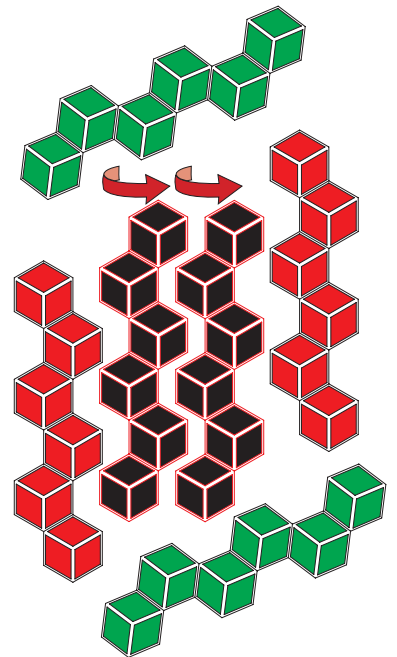

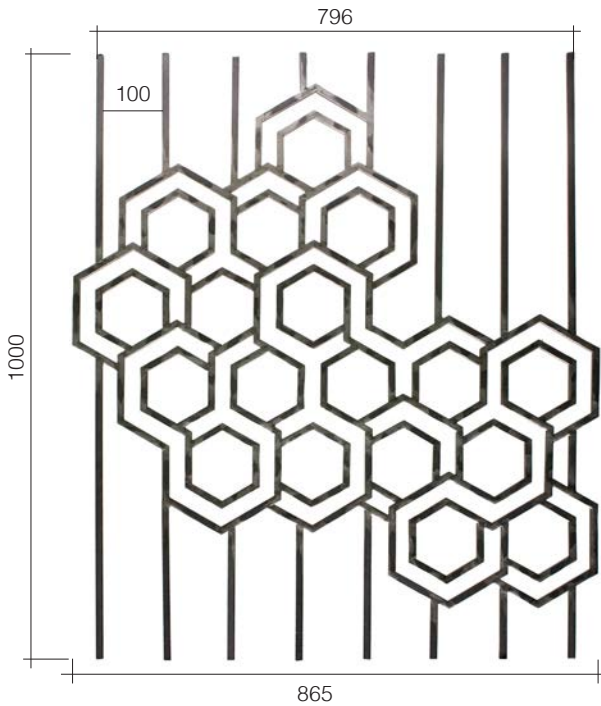

Art. GD301/1
Ø 12 x 12 mm
865 x 1000 mm

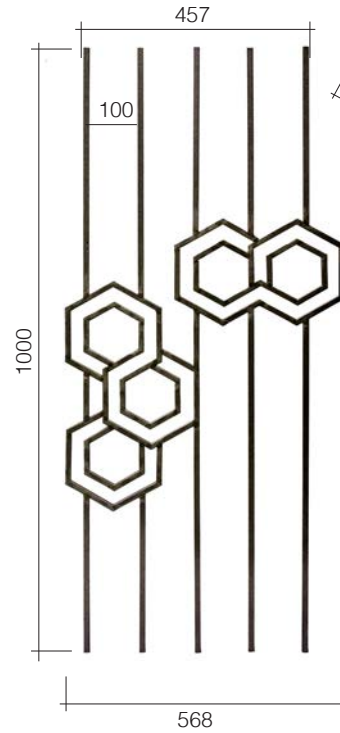

Art. GD301/3
Ø 12 x 12 mm
568 x 1000 mm

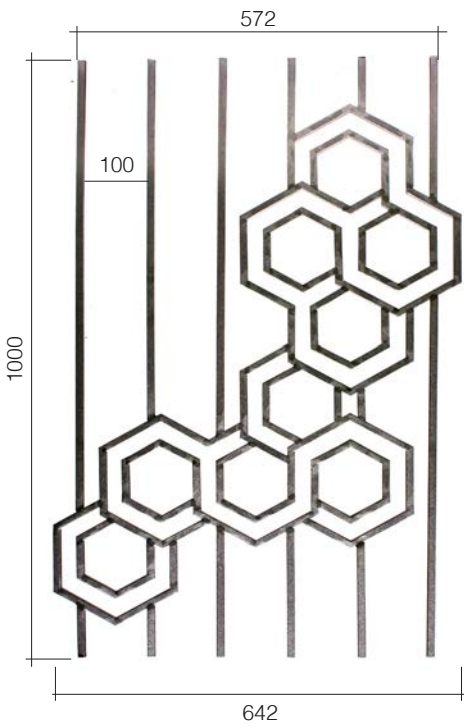
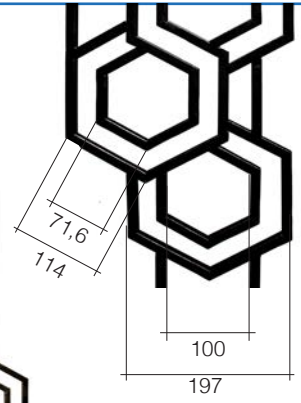

Art. GD301/2
Ø 12 x 12 mm
642 x 1000 mm

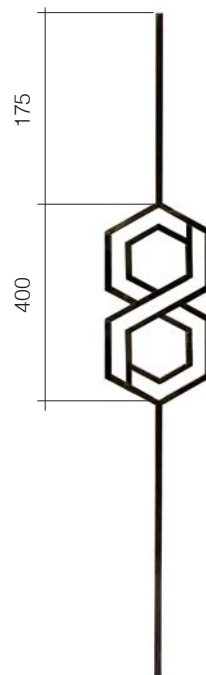

Art. GD301/5
Ø 12 x 12 mm
197 x 1000 mm

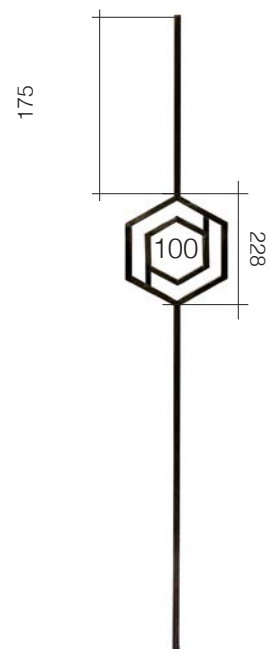

Art. GD301/4
Ø 12 x 12 mm
197 x 1000 mm



OVERLAPPED PANELS - PANNELLI SOVRAPPosti

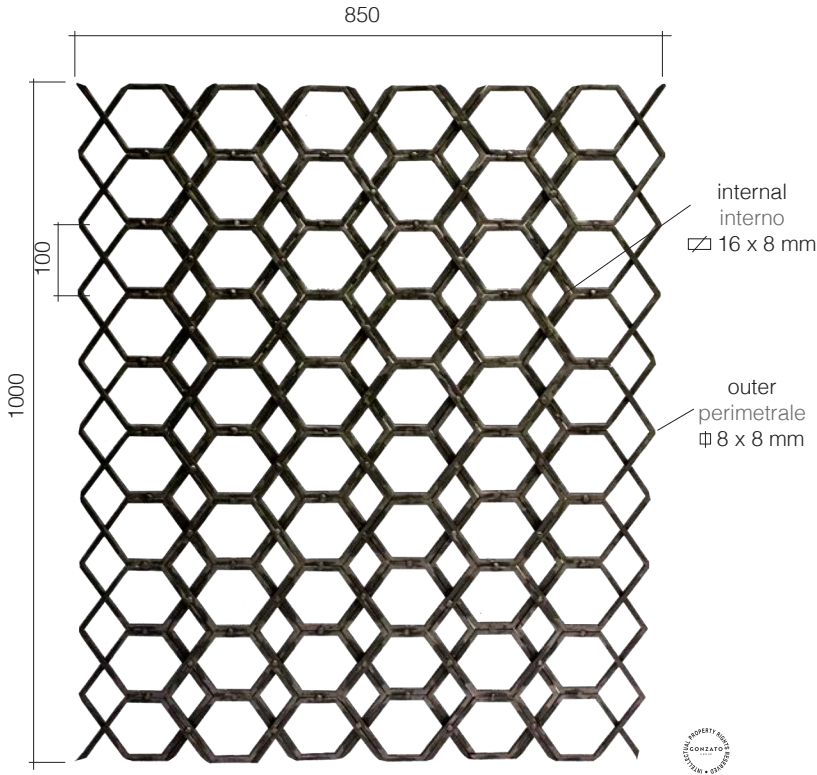

Art. GD299/1
 Φ 8 x 8 mm + \square 16 x 8 mm
 850 x 1000 mm

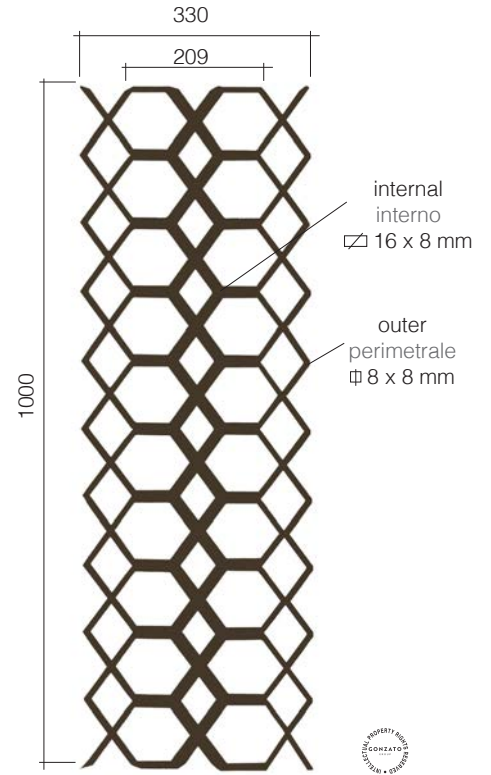

Art. GD299/2
 Φ 8 x 8 mm + \square 16 x 8 mm
 330 x 1000 mm

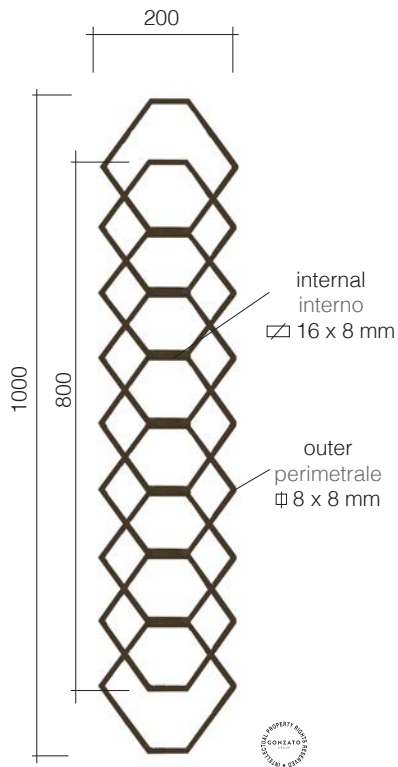

Art. GD299/3
 Φ 8 x 8 mm + \square 16 x 8 mm
 200 x 1000 mm

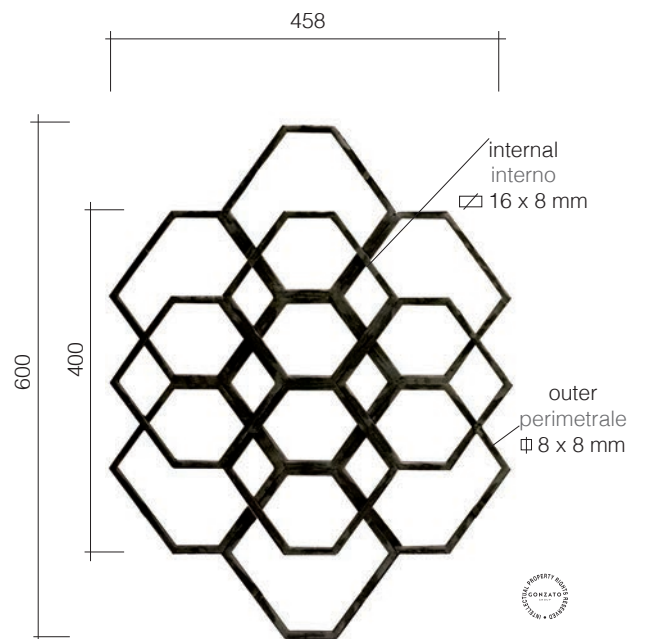

Art. GD299/4
 Φ 8 x 8 mm + \square 16 x 8 mm
 458 x 600 mm



OVERLAPPED PANELS
PANNELLI SOVRAPPOSTI

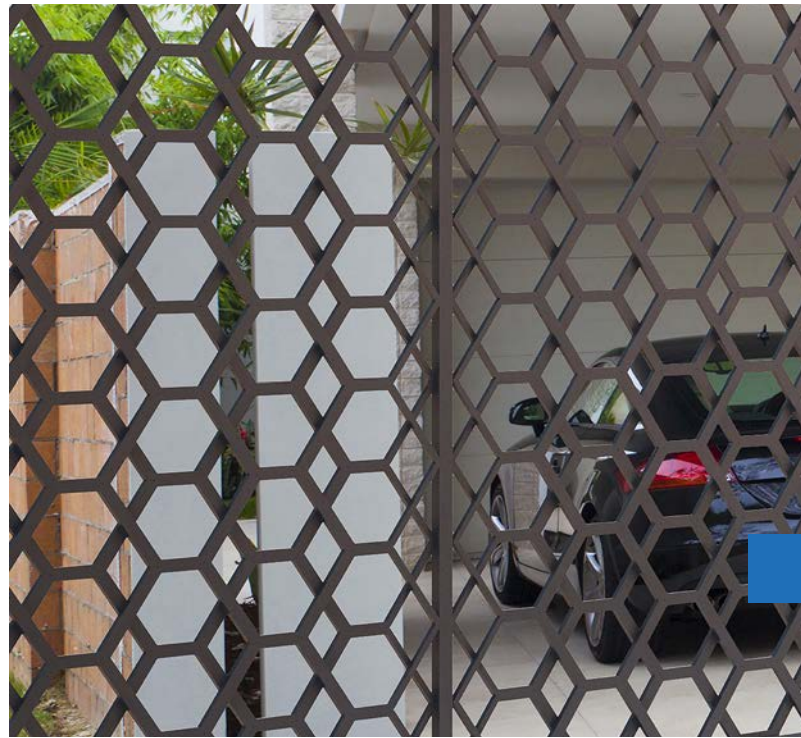

Panels with sheet metal, 1 mm thick
woven between rods, 8 mm diameter

Pannelli con lamiera spessore 1 mm
intrecciata tra tondini Ø 8 mm

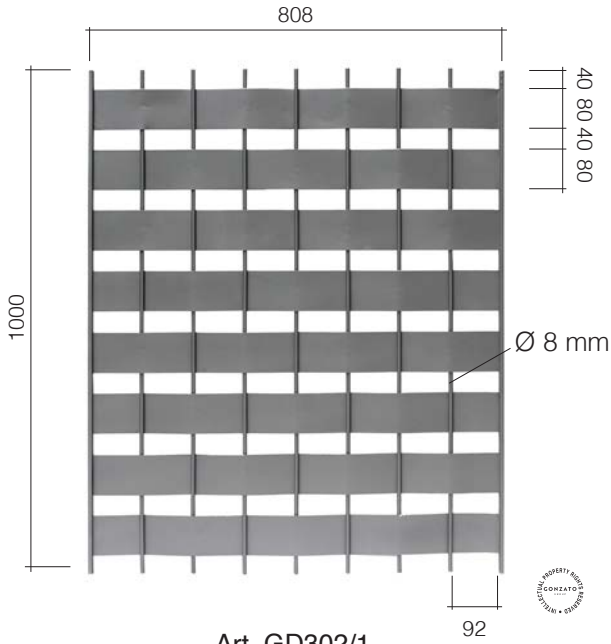

Art. GD302/1
16 x 8 mm
808 x 1000 mm

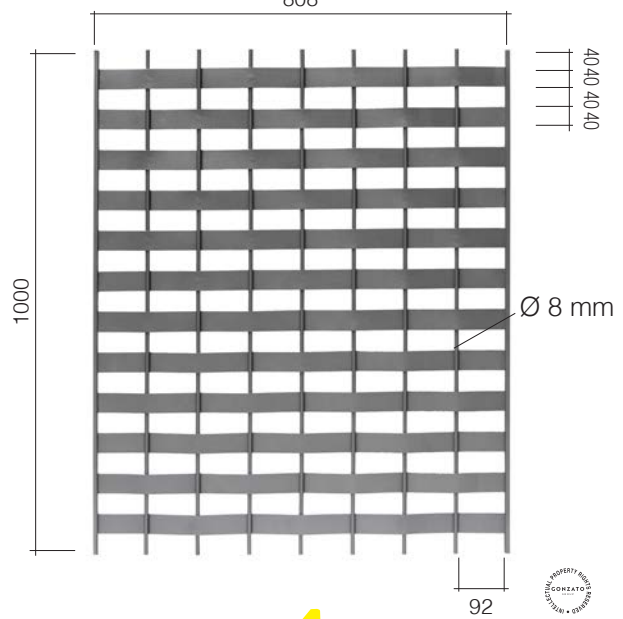

Art. GD302/2
16 x 8 mm
808 x 1000 mm

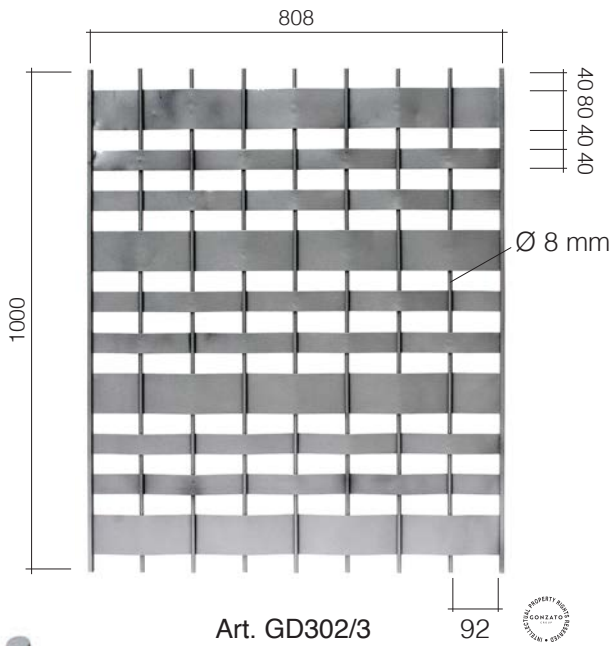

Art. GD302/3
16 x 8 mm
808 x 1000 mm

ATTENZIONE:
Viste le peculiarità del
prodotto, questo articolo è
solo **zincabile a freddo**.
Una zincatura a caldo
potrebbe comprometterne
l'estetica

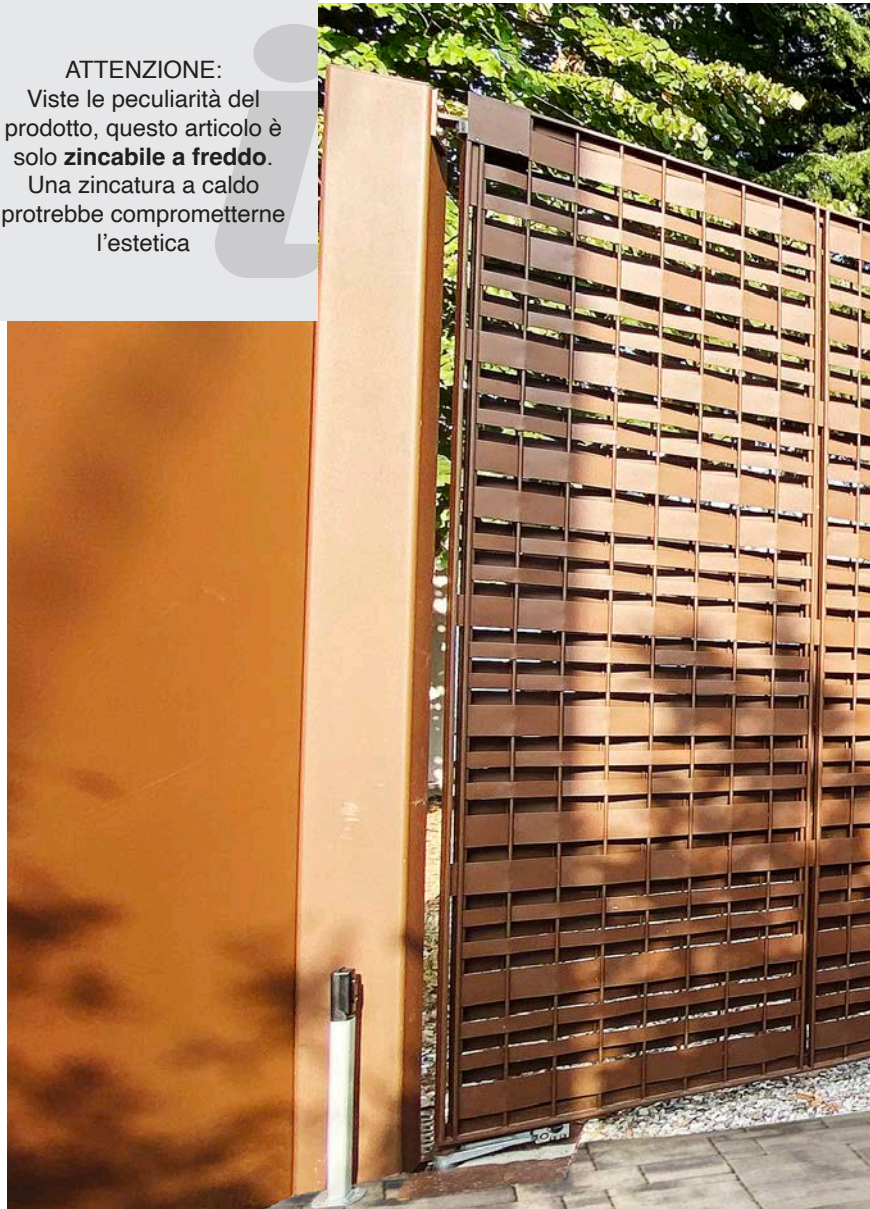
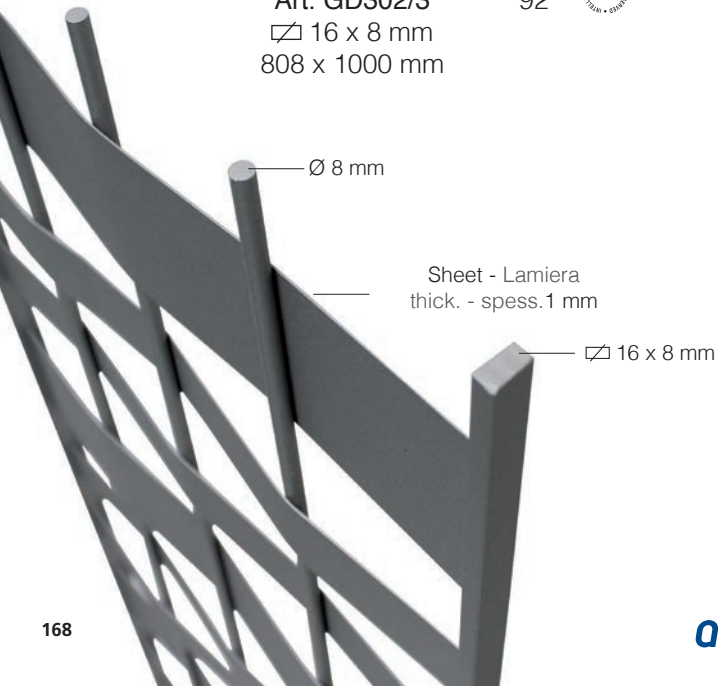

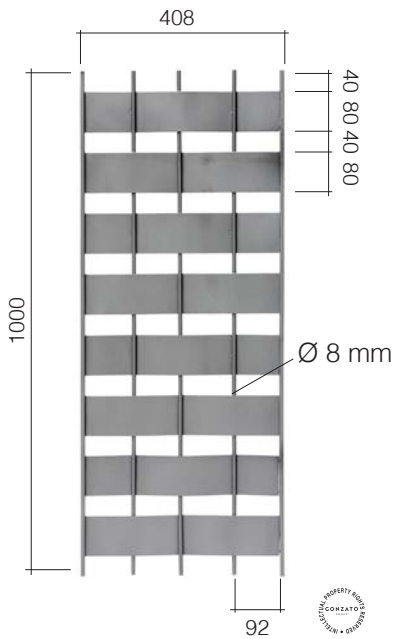

Art. GD303/1
 \square 16 x 8 mm
 408 x 1000 mm

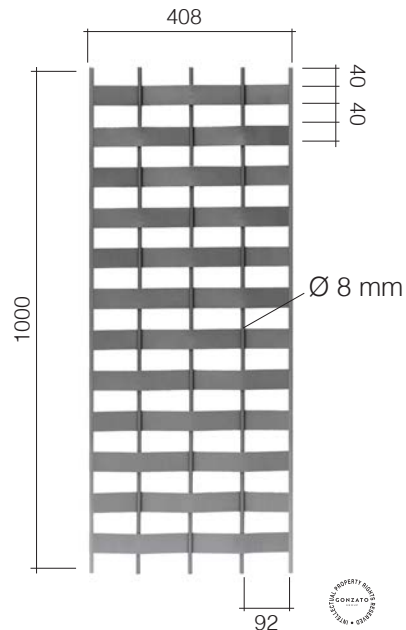

Art. GD303/2
 \square 16 x 8 mm
 408 x 1000 mm

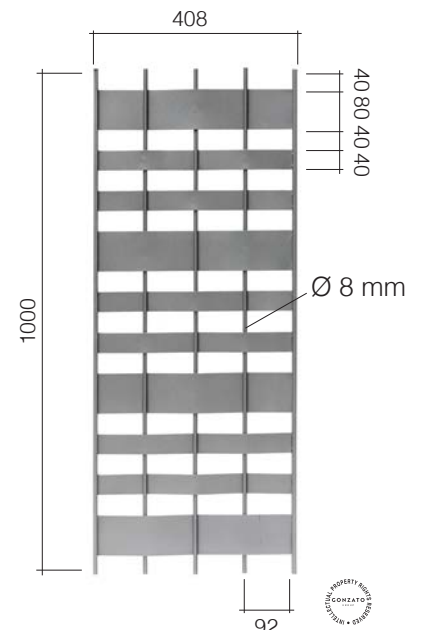

Art. GD303/3
 \square 16 x 8 mm
 408 x 1000 mm



CAUTION:
 Considering the peculiarities of this item only **cold galvanizing** is recommended. Hot dip galvanizing would compromise its shape.

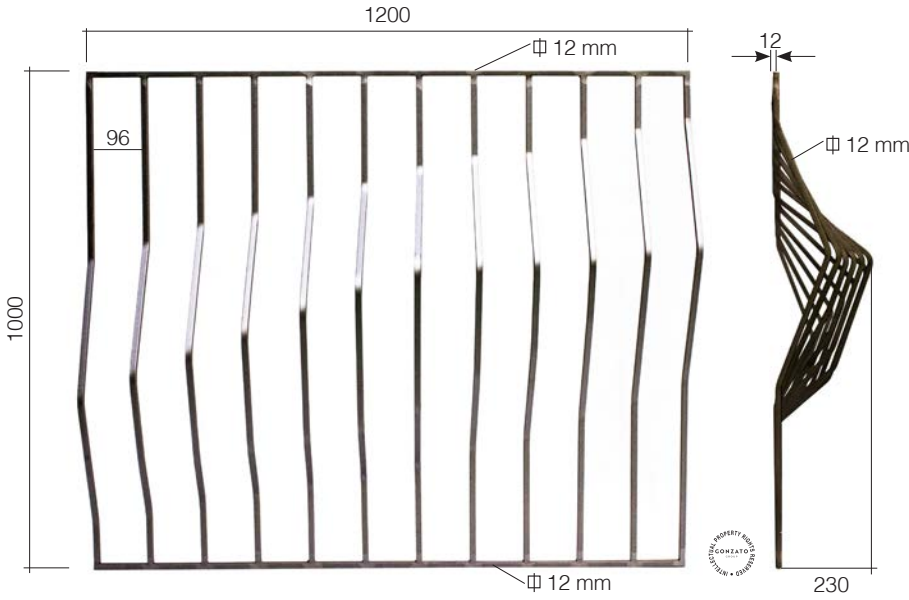

left - sinistro
Art. GD289/2
Φ 12 x 12 mm
1200 x 1000 mm

right - destro
Art. GD289/2/S
Φ 12 x 12 mm
1200 x 1000 mm

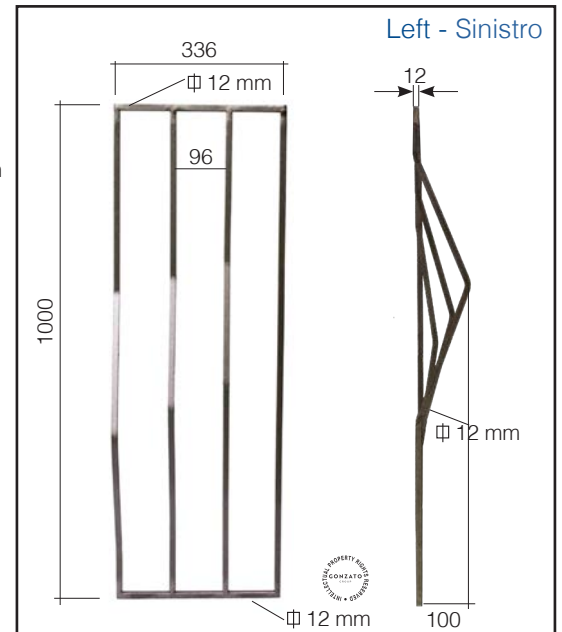

Left - Sinistro

left - sinistro
Art. GD293/3
Φ 12 x 12 mm
336 x 1000 mm

right - destro
Art. GD293/3/S
Φ 12 x 12 mm
336 x 1000 mm

Elements to lead the
buffing waves at level
zero

Elementi per portare
l'onda di tamponatura
a livello zero

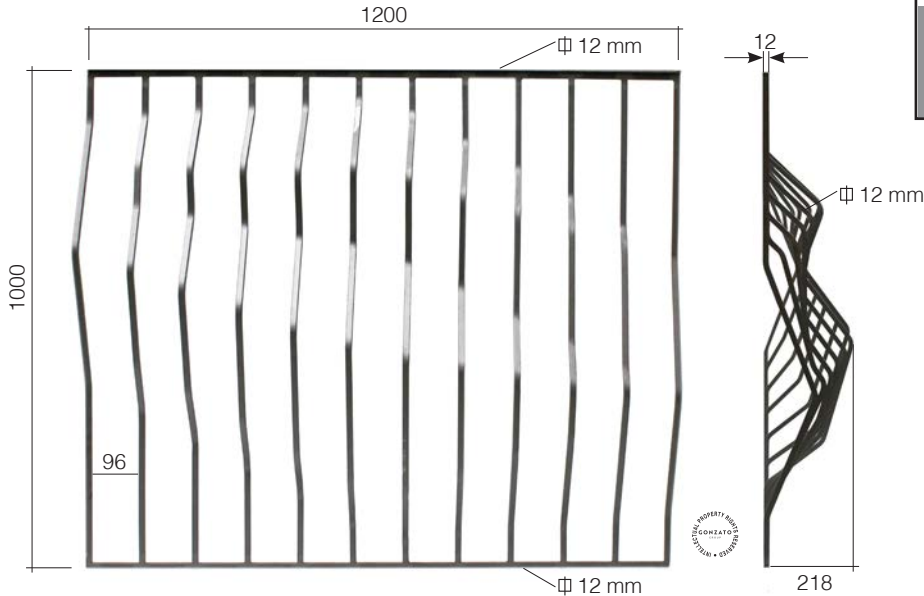

left - sinistro
Art. GD289/1
Φ 12 x 12 mm
1200 x 1000 mm

right - destro
Art. GD289/1/S
Φ 12 x 12 mm
1200 x 1000 mm

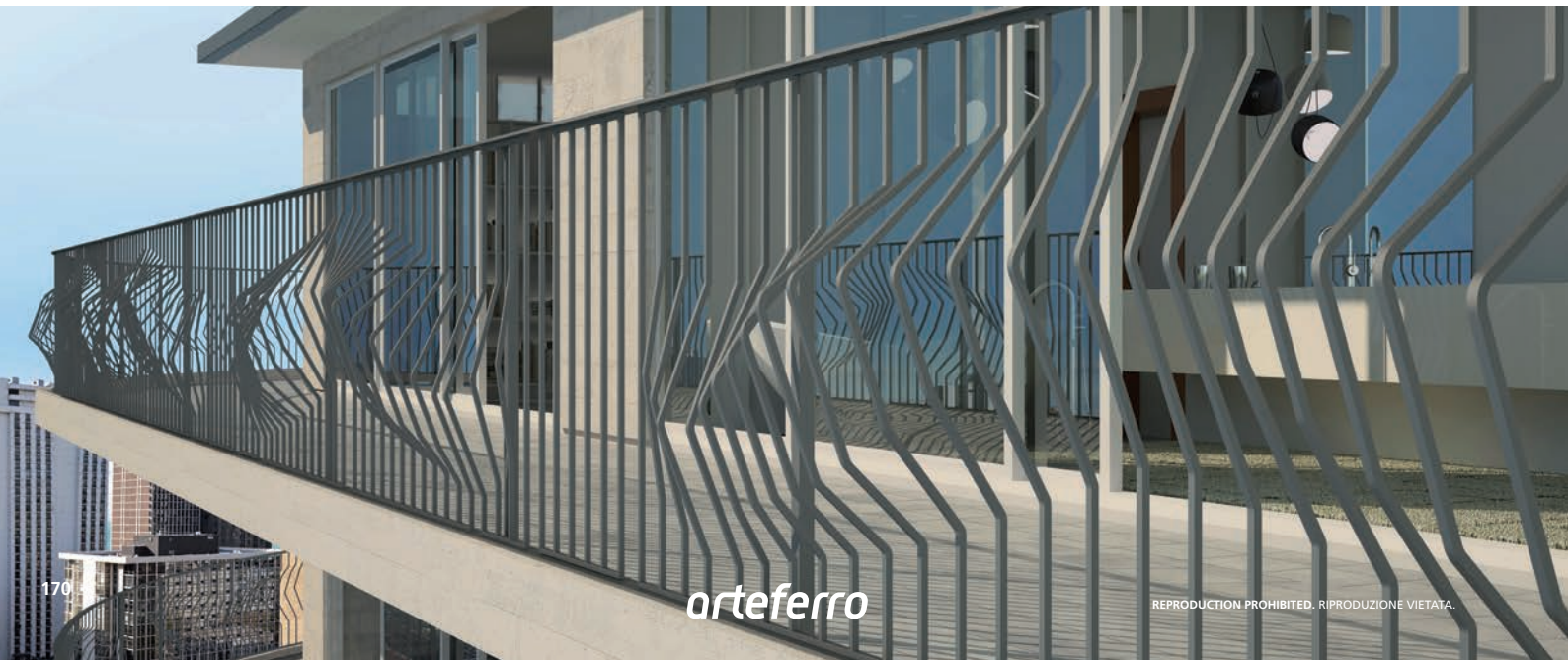

vertical elements Ø 12 mm
horizontal elements \square 12 mm

elementi verticali Ø 12 mm
elementi orizzontali \square 12 mm

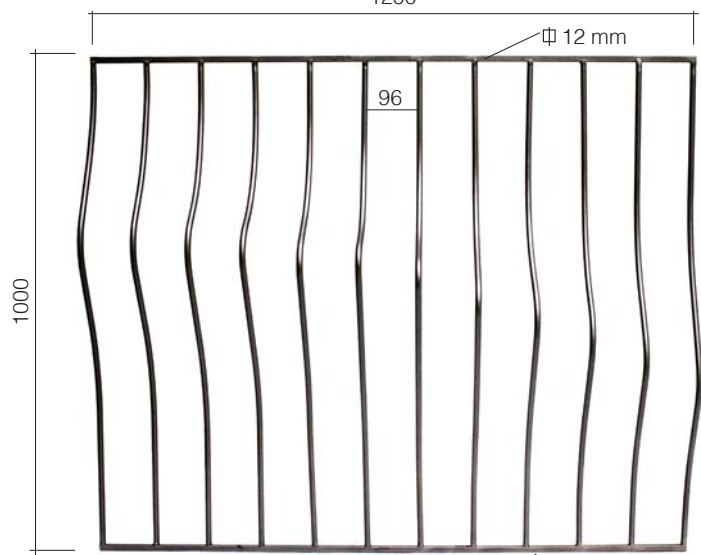

left - sinistro Art. GD294/1
right - destro Art. GD294/1/S
Ø 12 mm Ø 12 mm
1200 x 1000 mm 1200 x 1000 mm

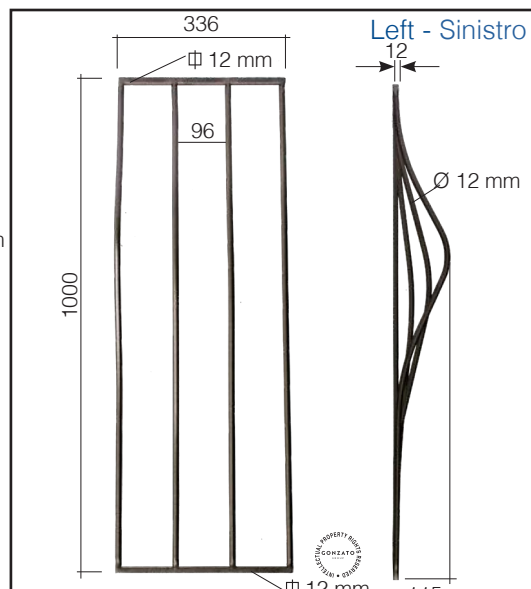

left - sinistro Art. GD294/3
right - destro Art. GD294/3/S
Ø 12 mm Ø 12 mm
336 x 1000 mm 336 x 1000 mm

Elements to lead the buffing waves at level zero

Elementi per portare l'onda di tamponatura a livello zero

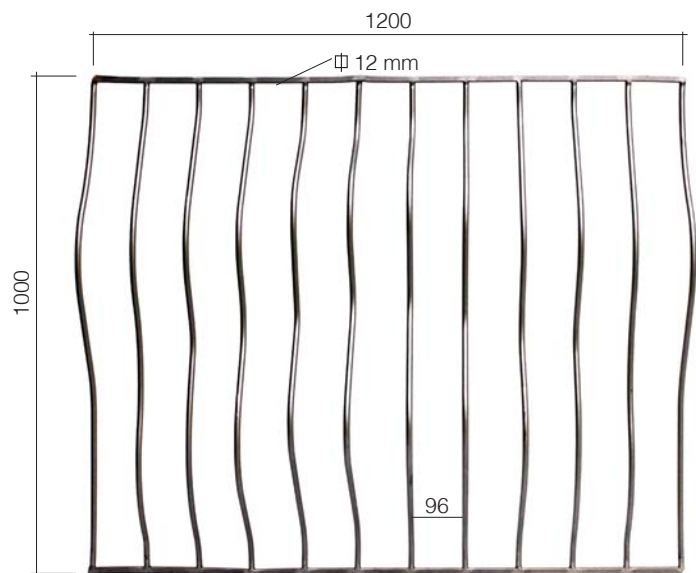

left - sinistro Art. GD294/2
right - destro Art. GD294/2/S
Ø 12 mm Ø 12 mm
1200 x 1000 mm 1200 x 1000 mm

vertical elements Ø 12 mm
horizontal elements \square 12 mm
elementi verticali Ø 12 mm
elementi orizzontali \square 12 mm

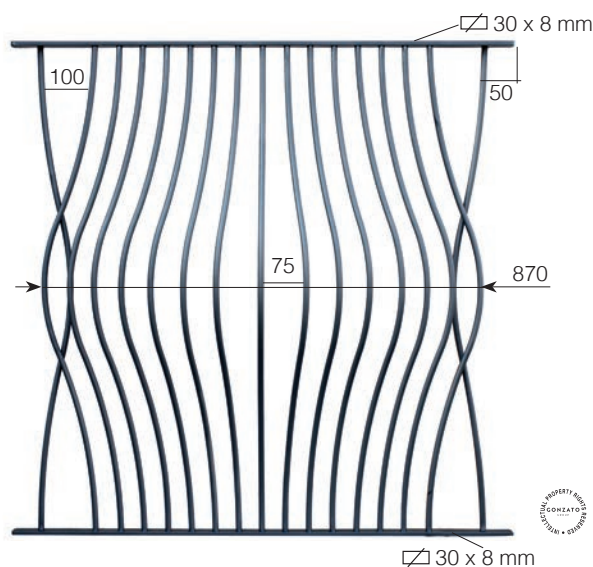

vertical elements Ø 12 mm
horizontal elements \square 30 x 8 mm
elementi verticali Ø 12 mm
elementi orizzontali \square 30 x 8 mm

Art. GD288/1
Ø 12 mm
1000 x 1000 mm

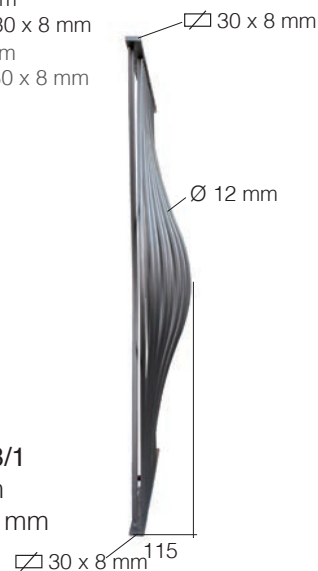



Left - Sinistro

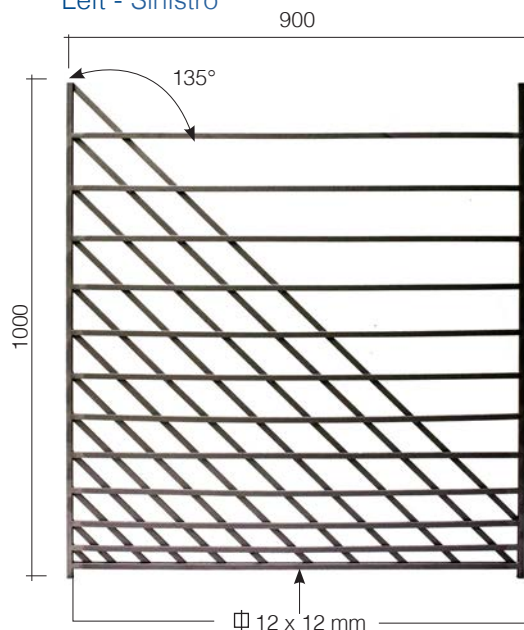

left - sinistro
Art. GD297/1
□ 12 x 6 mm + ∅ 12 mm
L 900 mm
H 1000 mm

right - destro
Art. GD297/2
□ 12 x 6 mm + ∅ 12 mm
L 900 mm
H 1000 mm

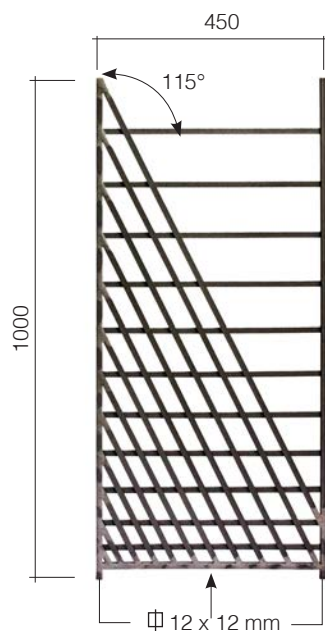

left - sinistro
Art. GD298/1
□ 12 x 6 mm + ∅ 12 mm
L 450 mm
H 1000 mm

right - destro
Art. GD298/2
□ 12 x 6 mm + ∅ 12 mm
L 450 mm
H 1000 mm



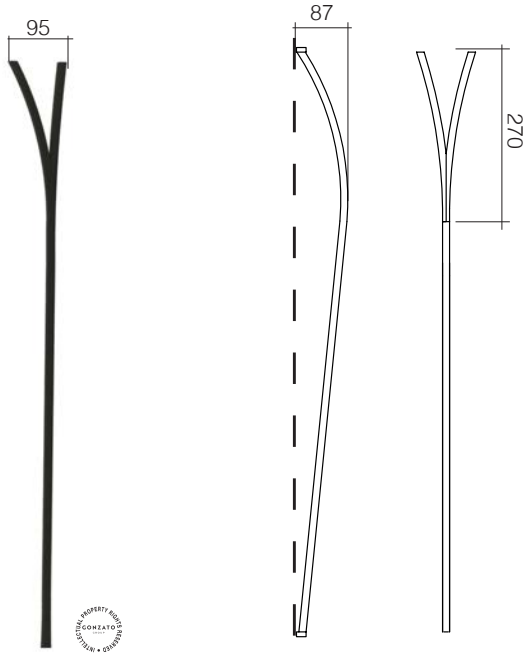

Art. GD290/2
Ø 12 mm
H 1000 mm

BEST PRICE

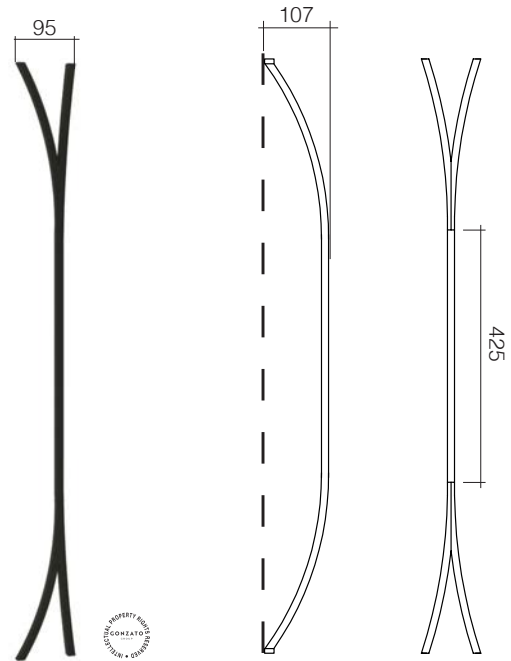

Art. GD290/1
Ø 12 mm
H 1000 mm



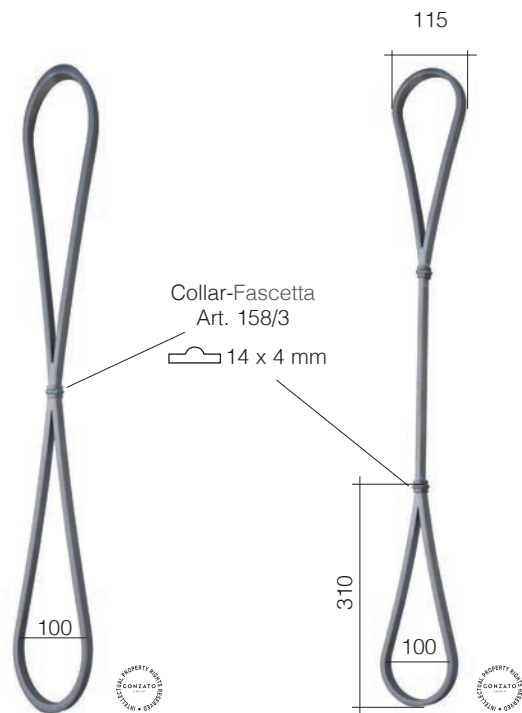

Art. GD179/2
14 x 8 mm
115 x 1000 mm

Art. GD179/1
14 x 8 mm
115 x 1000 mm

Horizontal flat bar
Piatti orizzontali
25 x 6 mm

Sphere-Sfere
Art. 116/F/3
Ø 30 mm

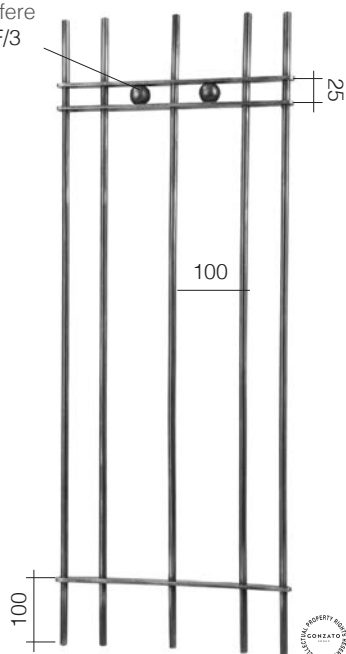

Art. GD47/3
Ø 12 mm
360 x 1000 mm

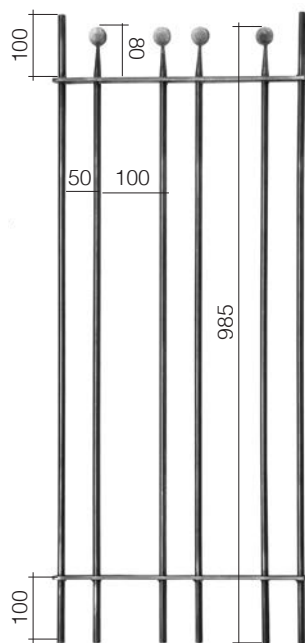

Art. GD47/1
Ø 12 mm
L 420 mm
H 1000 mm

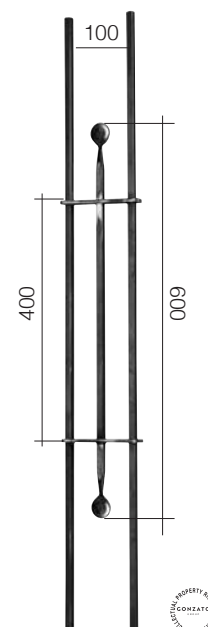

Art. GD67/1
Ø 12 mm
L 125 mm
H 1000 mm

Spheres - Sfere Ø 30 mm

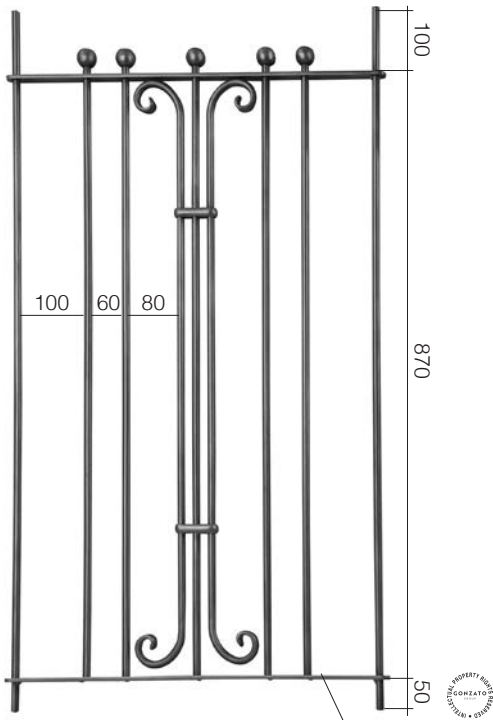

Art. GD45/1
Ø 12 mm
610 x 1000 mm
25 x 6 mm

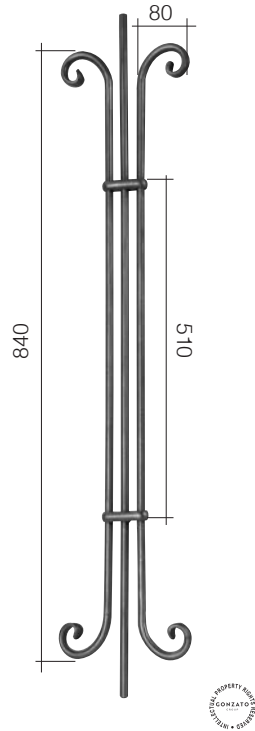

Art. GD45/2
Ø 12 mm
200 x 1000 mm

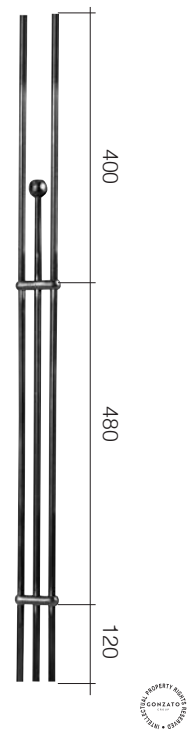

Art. GD39/2
Ø 12 mm
60 x 1000 mm

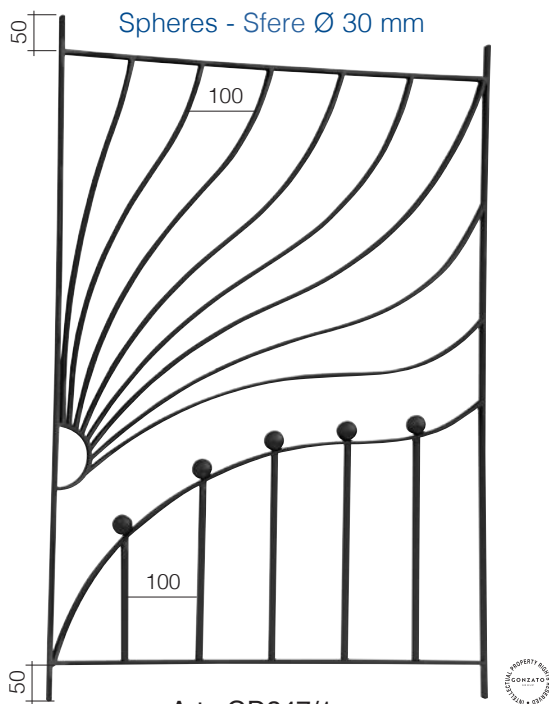

Art. GD247/1
20 x 6 mm
670 x 1000 mm



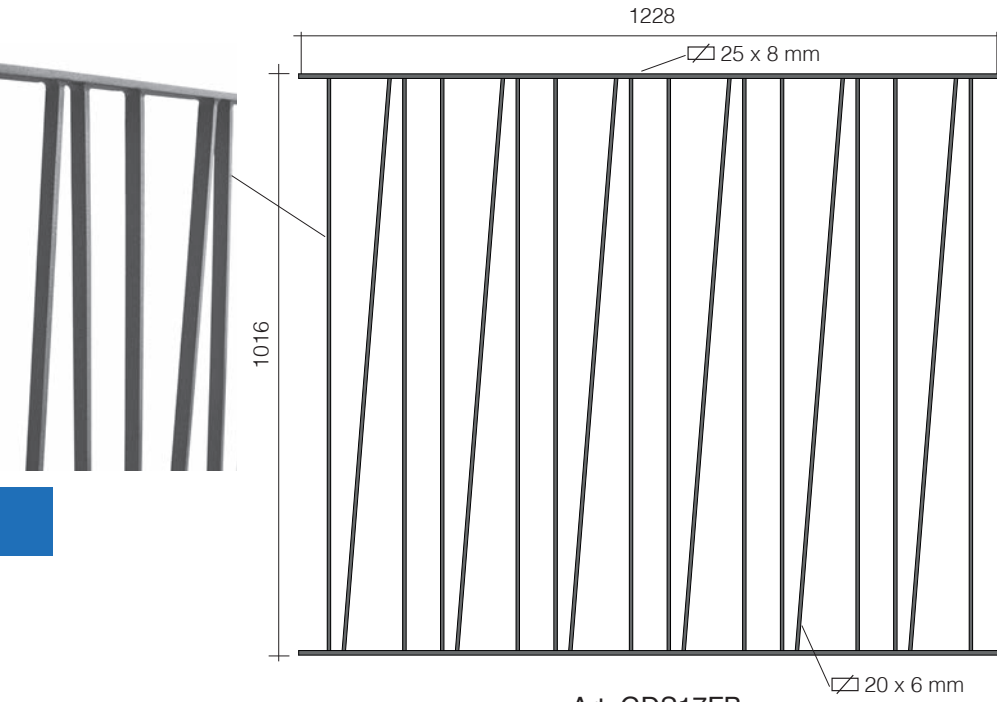

Art. GDS17FB
20 x 6 mm
1228 x 1016 mm

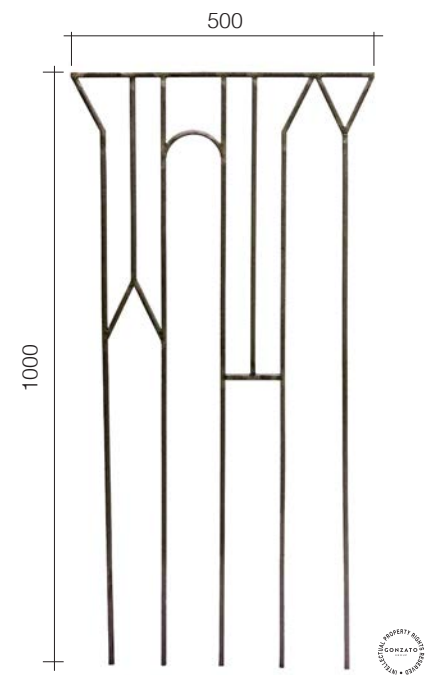

Art. GD295/1
14 x 8 mm
500 x 1000 mm

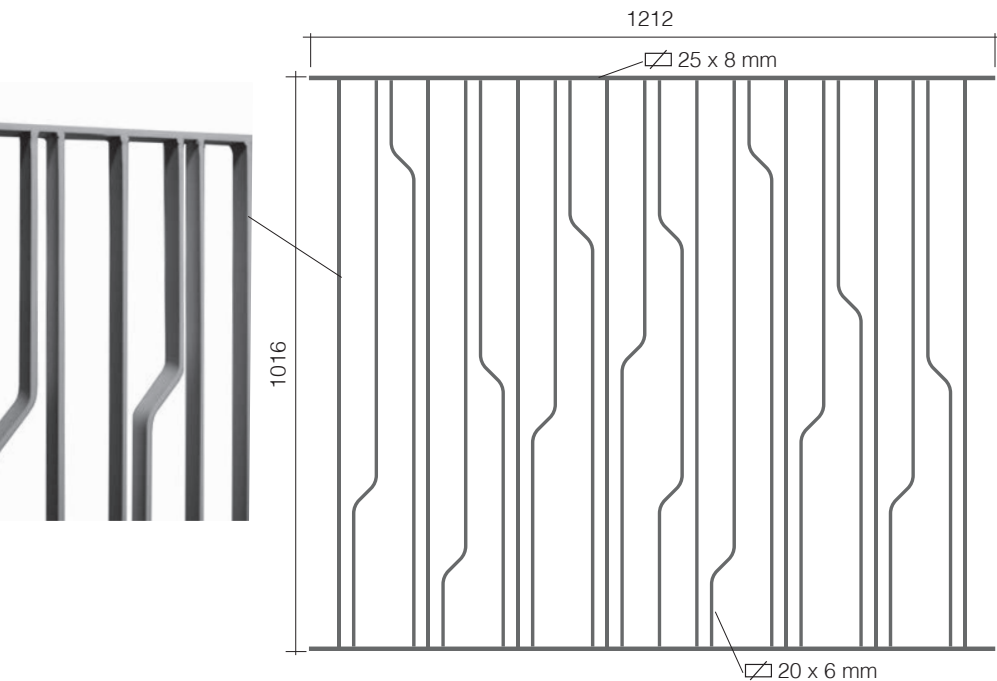

Art. GDS20FB
20 x 6 mm
1212 x 1016 mm

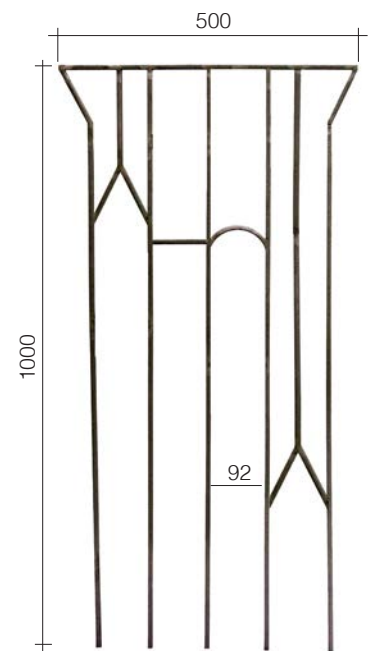

Art. GD295/2
14 x 8 mm
500 x 1000 mm

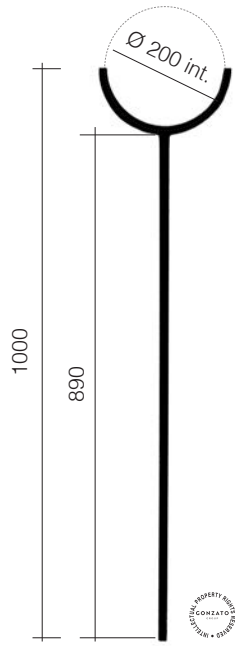

Art. GD296/1
Ø 12 x 12 mm
Ø 224 x 1000 mm

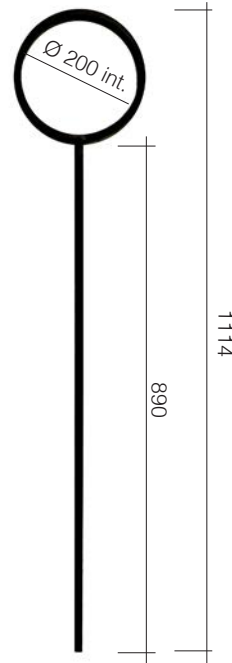

Art. GD296/2
Ø 12 x 12 mm
Ø 224 x 1114 mm



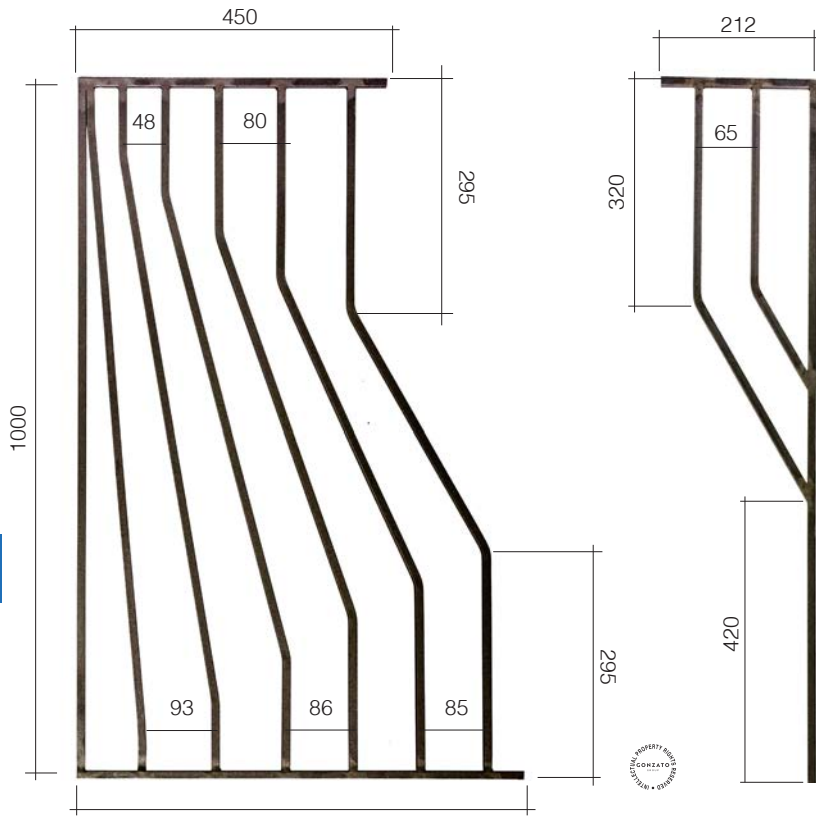

Art. GD212/2
 Φ 12 x 12 mm
 650 x 1000 mm

Art. GD212/3
 Φ 12 x 12 mm
 212 x 1000 mm

ESEMPIO DI MONTAGGIO
 MOUNTING EXAMPLE

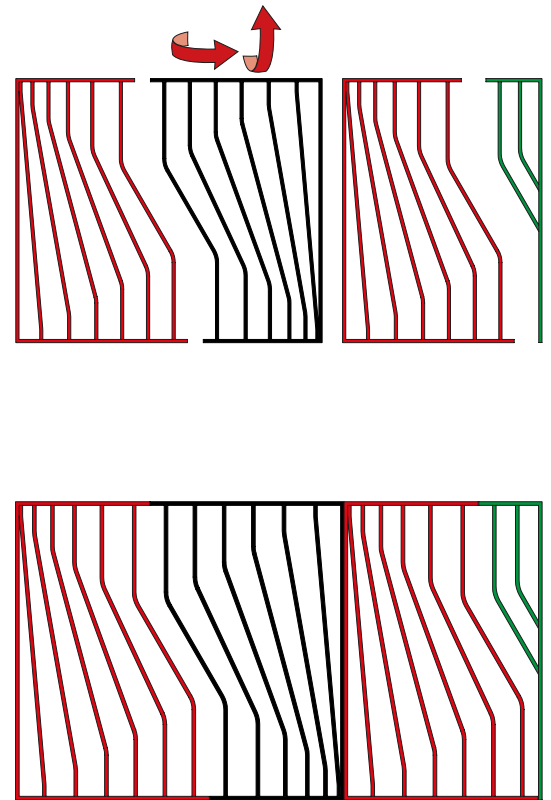



Art. GD222/1

▧ 14 x 8 mm

H 1000 mm

L 500 mm



Art. GD222/2

▧ 14 x 8 mm

H 1000 mm

L 500 mm

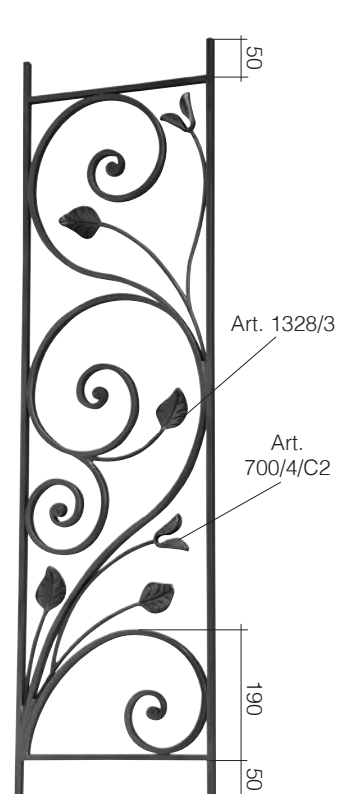

Art. GD223/1

▧ 14 x 8 mm

H 1000 mm

L 275 mm

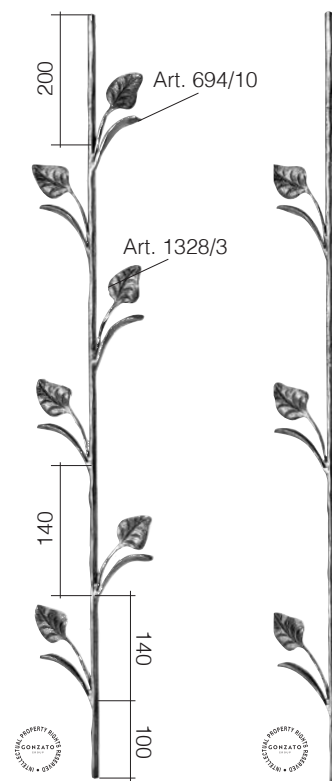

Art. 1170/1

Ø 12 mm

130 x 1000 mm

Art. 1170/5

Ø 12 mm

70 x 1000 mm



Art. 1170/2

Ø 12 mm

130 x 1000 mm



Art. 1171/1

Ø 12 mm

120 x 1000 mm

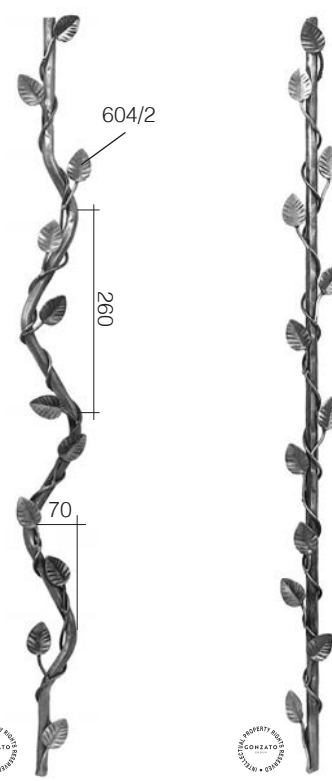

Art. 604/6

Ø 12 mm

H 1000 mm



Art. 604/7

Ø 12 mm

H 1000 mm

Art. 604/2

Ø 16 mm

H 1000 mm

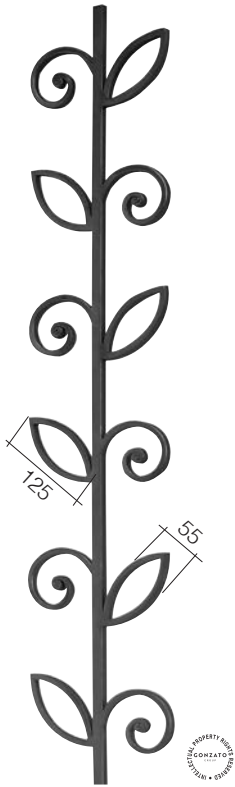

Art. GD176/3
Ø 14 x 14 mm
200 x 1000 mm

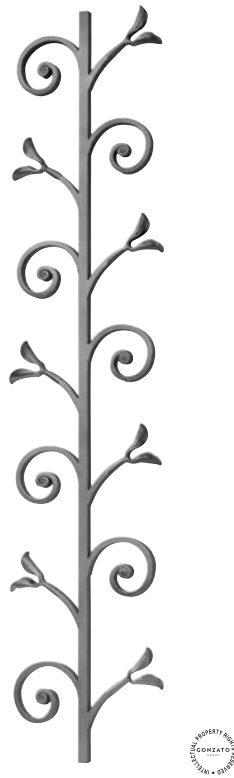

Art. GD176/2
Ø 14 x 14 mm
200 x 1000 mm



Art. GD176/1
Ø 14 x 14 mm
200 x 1000 mm

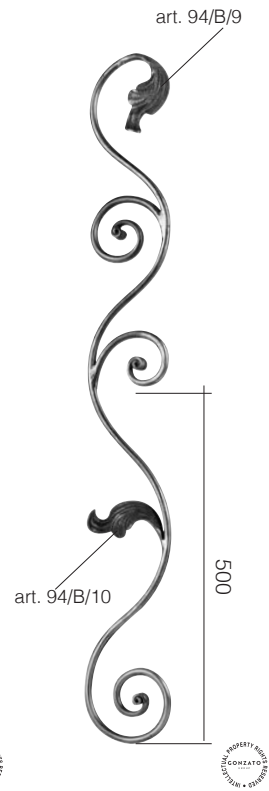

Art. GD170/1
Ø 12 mm
130 x 1000 mm

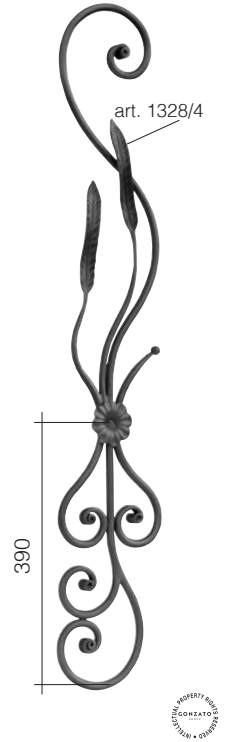

Art. GD170/2
Ø 12 mm
170 x 1000 mm



Ornamenti / Ornaments \square 14 x 8 mm

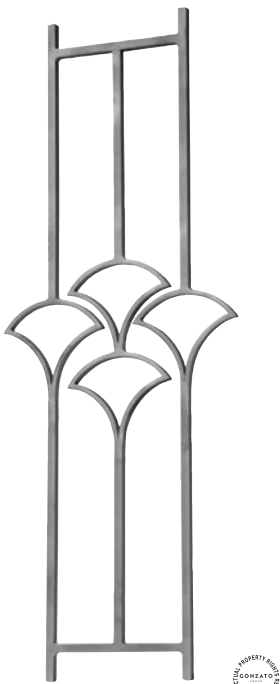

Art. GD186/2
 \square 14 mm
390 x 1000 mm

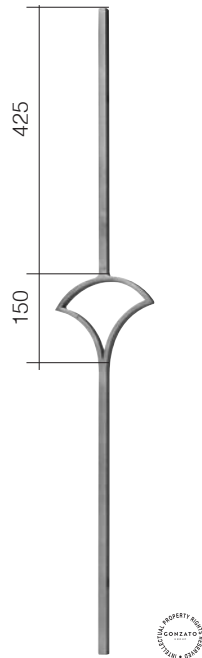

Art. GD186/1
 \square 14 mm
170 x 1000 mm

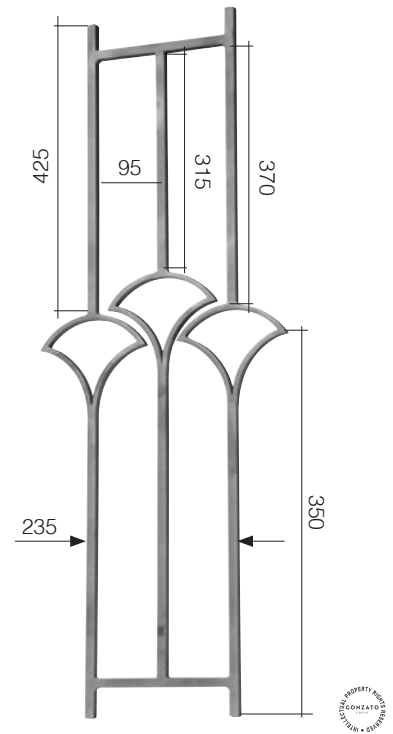

Art. GD186/3
 \square 14 mm
390 x 1000 mm

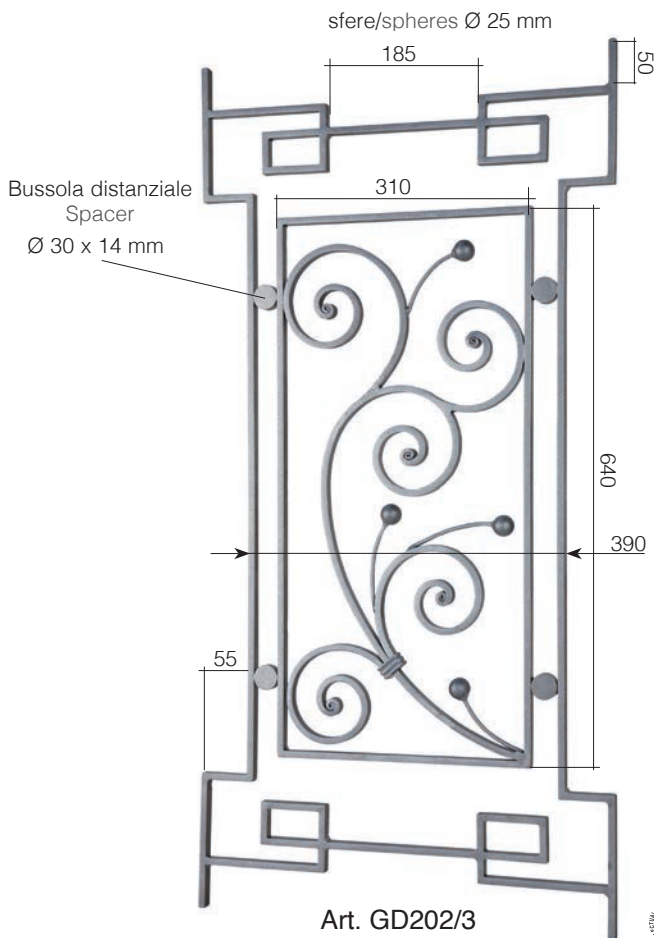

Art. GD202/3
 \square 14 x 8 mm
500 x 1000 mm



Art. GD202/5
 \square 14 x 8 mm
315 x 635 mm

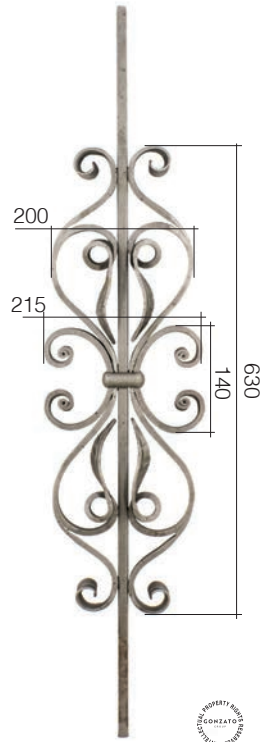

Art. GD28/1
Ø 14 mm
215 x 1000 mm

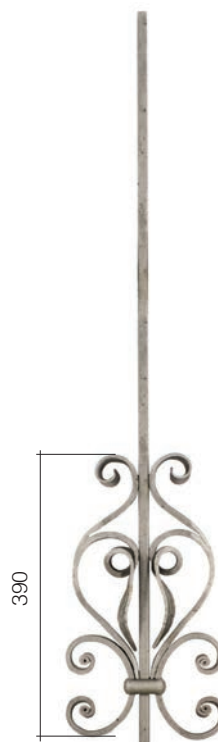

Art. GD28/2
Ø 14 mm
215 x 1000 mm

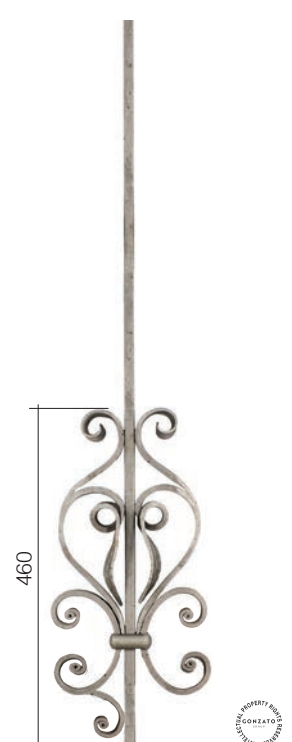

Art. GD28/3
Ø 14 mm
215 x 1000 mm

Piatti orizzontali
Horizontal flat bar
▧ 25 x 6 mm

Sfera - Sphere
Art. 116/F/4 Ø 40 mm

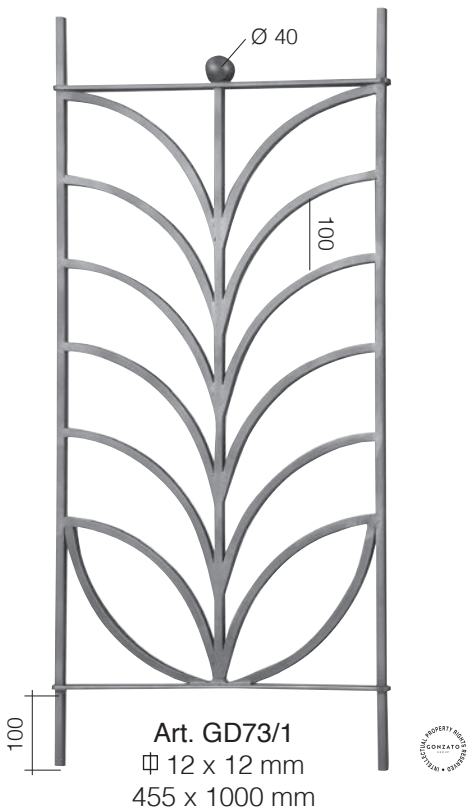

Art. GD73/1
Ø 12 x 12 mm
455 x 1000 mm

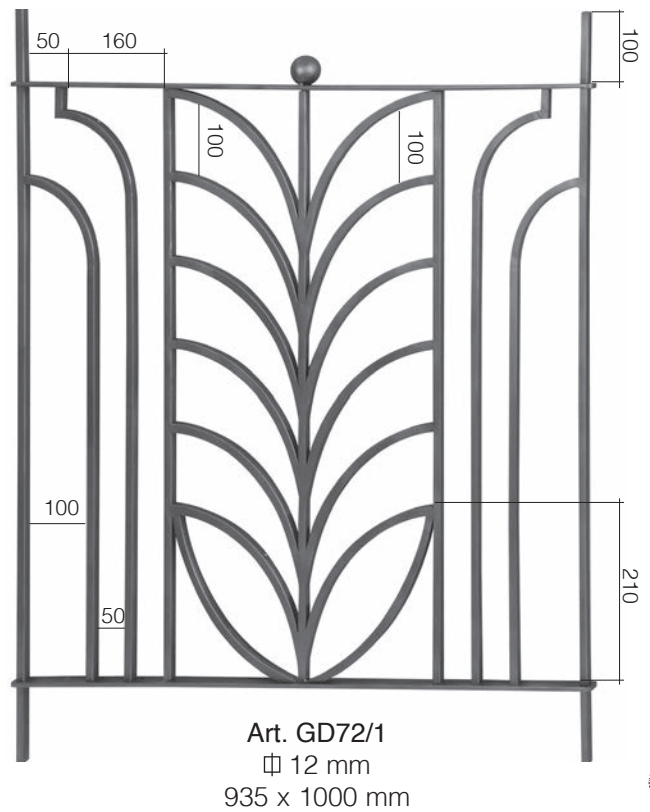

Art. GD72/1
Ø 12 mm
935 x 1000 mm

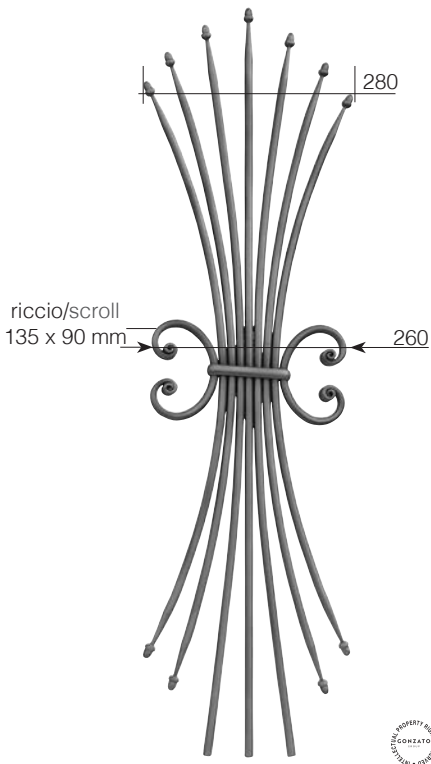

Art. GD255/1
Ø 12 mm
280 x 1000 mm



Art. 1171/2
Ø 12 mm
60 x 1000 mm



Art. GD92/3
Ø 12 mm
100 x 1000 mm

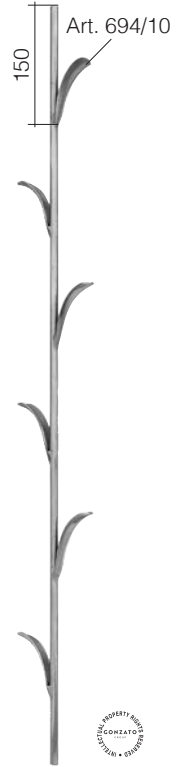

Art. GD92/2
Ø 12 mm
130 x 1000 mm

spheres - sfere 116/F/4 Ø 40 mm

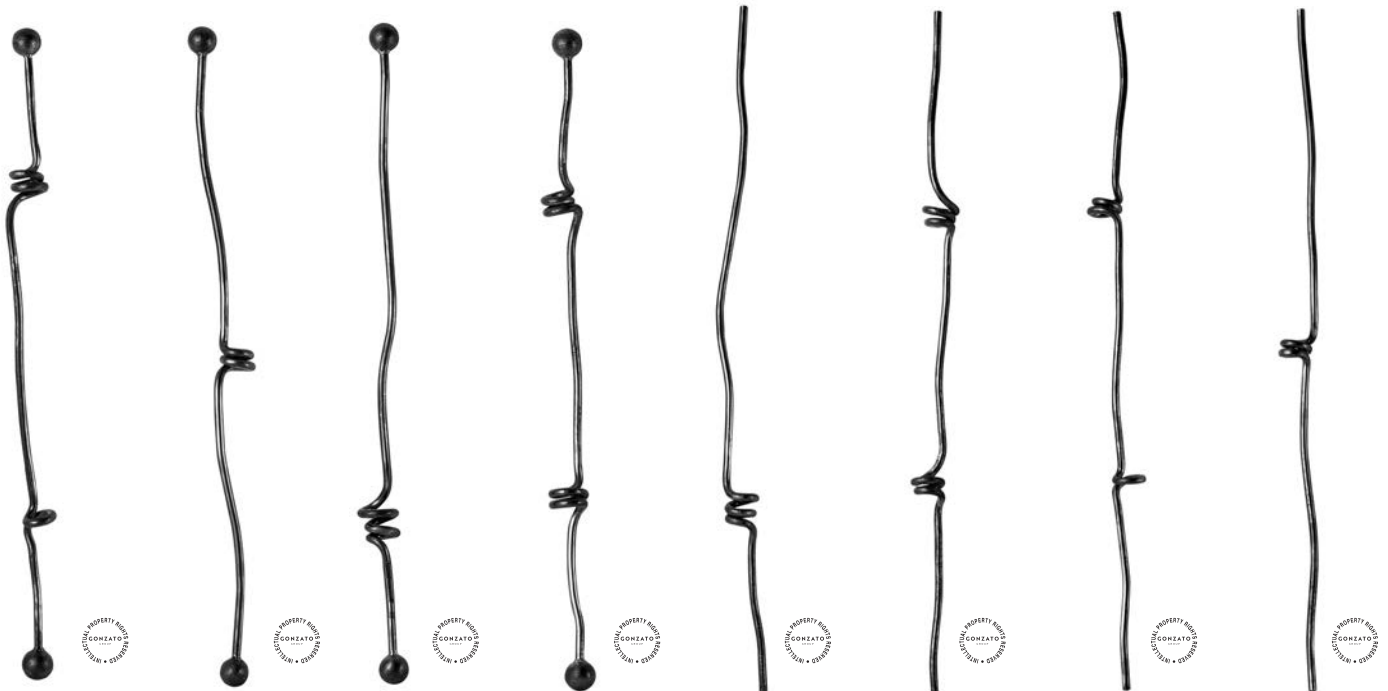

Art. 1166/1
Ø 12 mm
H 900 mm

Art. 1166/2
Ø 12 mm
H 900 mm

Art. 1166/3
Ø 12 mm
H 900 mm

Art. 1166/4
Ø 12 mm
H 900 mm

Art. 1167/3
Ø 12 mm
H 1000 mm

Art. 1167/4
Ø 12 mm
H 1000 mm

Art. 1167/1
Ø 12 mm
H 1000 mm

Art. 1167/2
Ø 12 mm
H 1000 mm



Art. 715/1
Ø 12 mm
580 x H 880 mm
left - sinistro



Art. 715/2
Ø 12 mm
580 x H 880 mm
right - destro

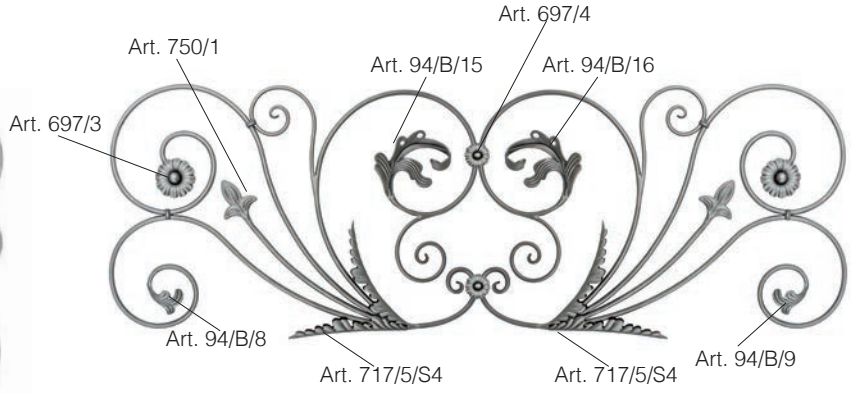

Art. 713/2
Ø 12 mm
1780 x H 580 mm



Art. 716/1
Ø 12 mm
920 x H 1280 mm
left - sinistro



Art. 716/2
Ø 12 mm
920 x H 1280 mm
right - destro

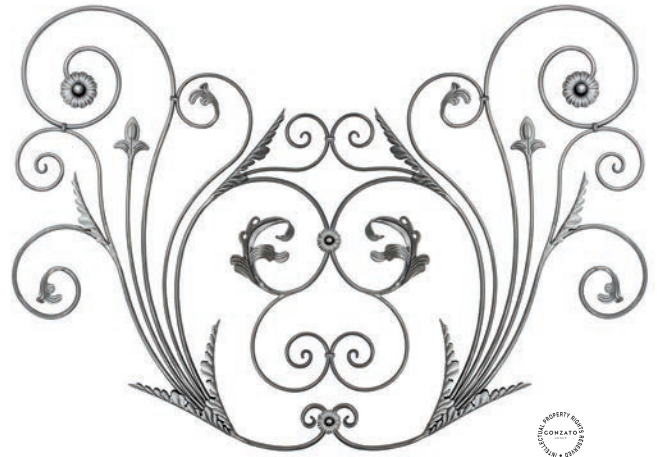

Art. 714/1
Ø 12 mm
1600 x H 1150 mm



Art. 716/3
Ø 12 mm
760 x H 890 mm
right - destro



Art. 716/4
Ø 12 mm
760 x H 890 mm
left - sinistro



Art. 713/1
Ø 12 mm
1780 x H 760 mm

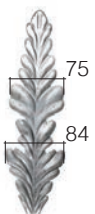

Art. 717/5/S1
H 285 mm
Ø 2 mm

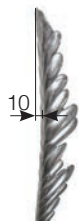

Art. 717/5/S3
L 25 x H 290 mm
Ø 2 mm



Art. 696/3
H 430 x L 400 mm

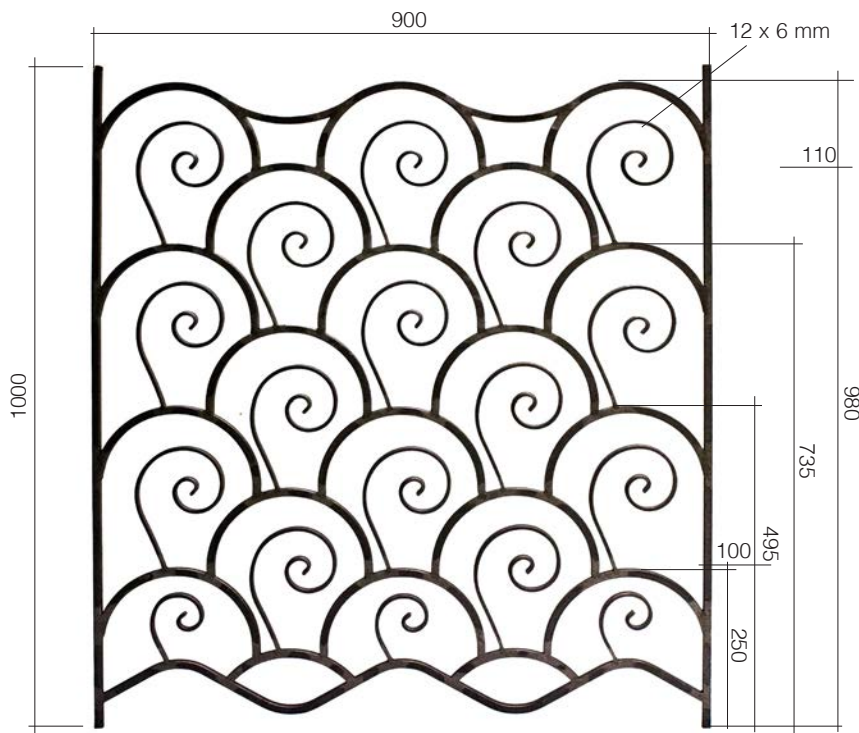

Art. GD291/2
□ 12 x 12 mm
900 x 1000 mm



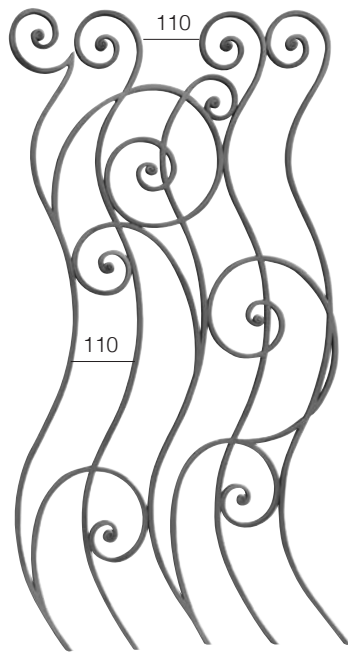

Art. GD226/3
 □ 14 x 8 mm
 535 x 1000 mm

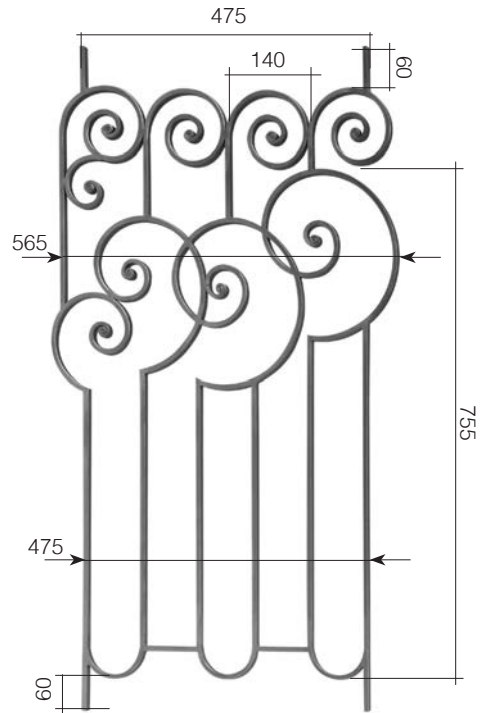

Art. GD228/1
 □ 14 x 8 mm
 580 x 1000 mm



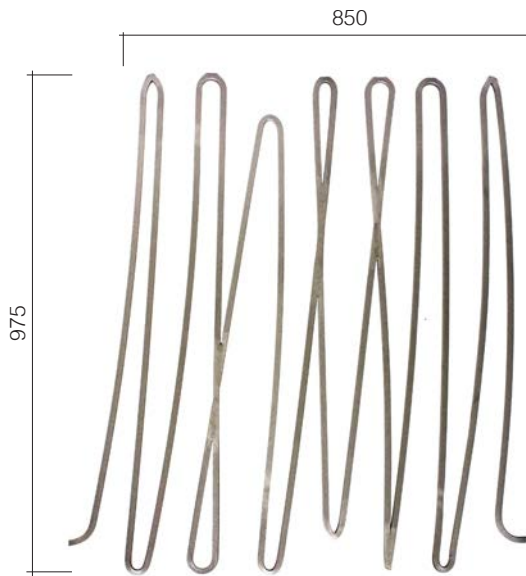

Art. GD300/1
Φ 12 x 12 mm
850 x 975 mm

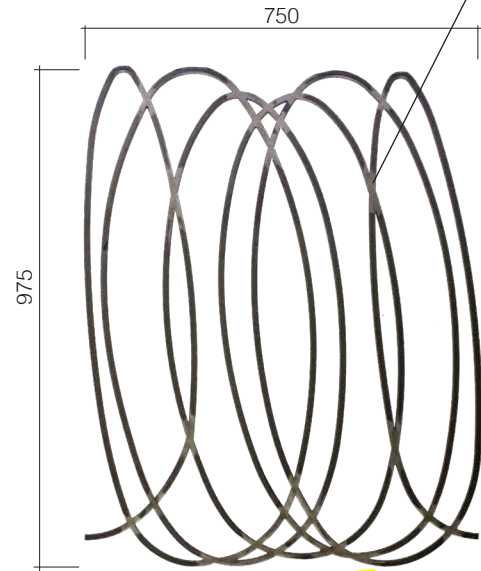

Art. GD300/2
Φ 12 x 12 mm
750 x 975 mm



Art. GD300/3
Φ 12 x 12 mm
465 x 975 mm



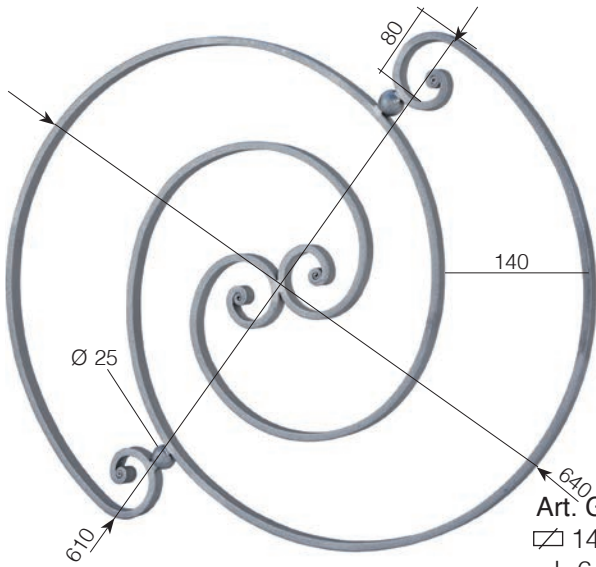

Art. GD285/1
□ 14 x 8 mm
L 640 mm
H 610 mm

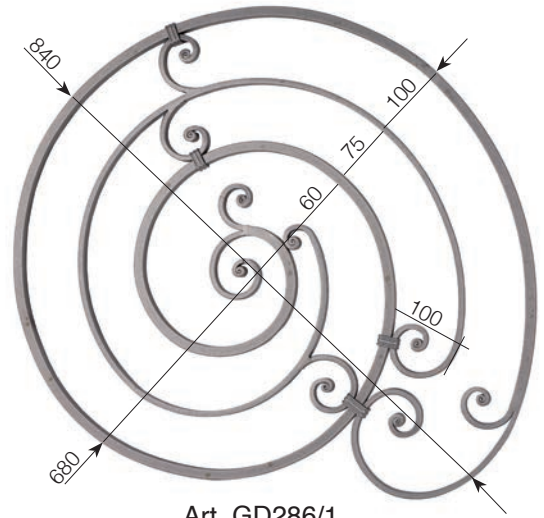

Art. GD286/1
□ 14 mm + □ 14 x 8 mm
L 840 mm
H 680 mm

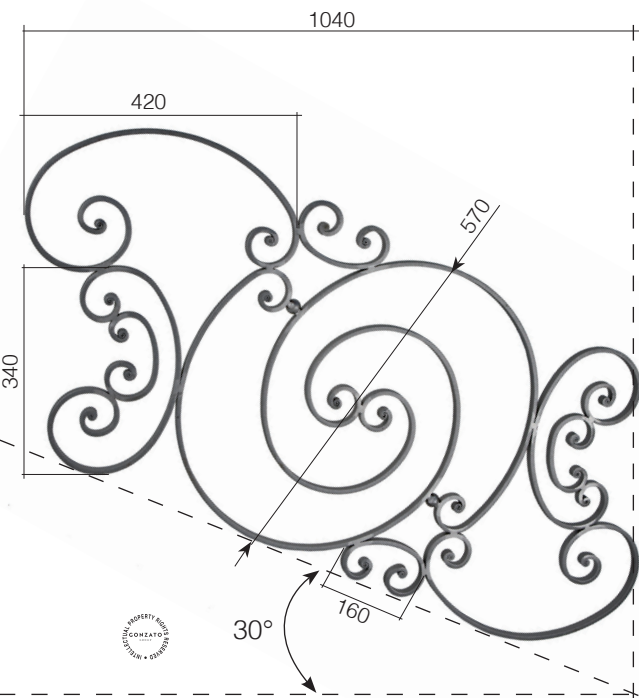

Art. GD231/2/S3
□ 14 x 8 mm
570 x 1200 mm

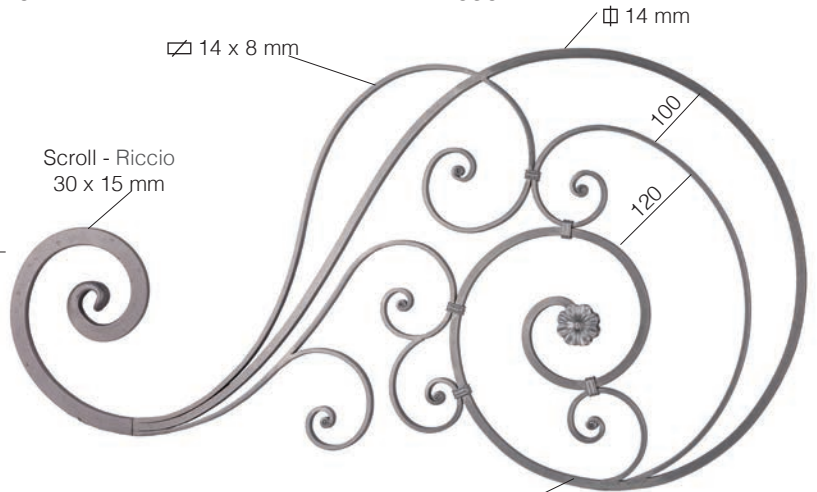

Art. GD285/2
□ 14 mm + □ 14 x 8 mm
L 1360 mm
H 700 mm

art. 116/A/4
on both sides
sui due lati

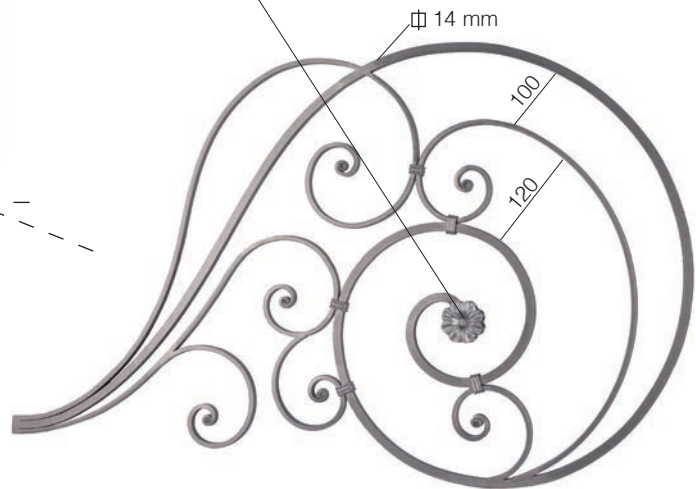

Art. GD285/5
□ 14 mm + □ 14 x 8 mm
L 1200 mm
H 700 mm

Sec.Sez.	Finish - Finitura	Art.	Art.	Art.	Art.	Art.	Art.	Art.
∅ 12 mm	Plain Liscio	1089/1	1089/3	1089/4	1090/1	1090/3	1090/4	1091/2

Ornaments - Ornamenti \sphericalangle 12 x 6 mm

Sec.Sez.	Finish - Finitura	Art.	Art.	Art.	Art.	Art.	Art.	Art.
∅ 12 mm	Plain Liscio	1324/11	1324/12	1324/3	1324/4	1324/5	1324/7	1324/8



Art. GD187/1
 \varnothing 14 mm
 190 x 1000 mm

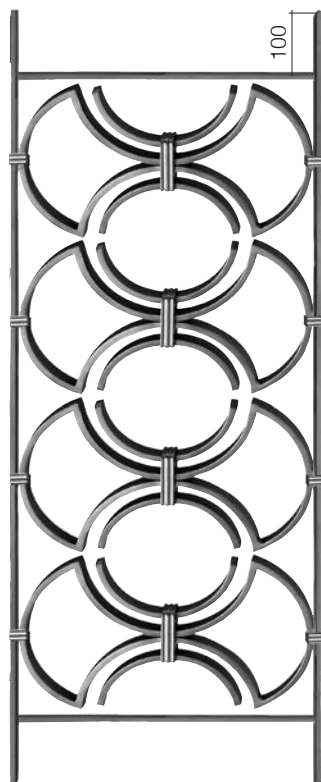

Art. GD189/2
 \varnothing 14 x 8 mm
 340 x 1000 mm

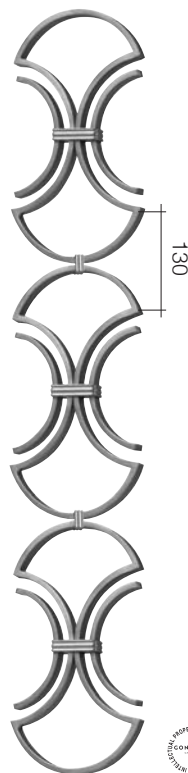

Art. GD189/1
 \varnothing 14 x 8 mm
 190 x 975 mm

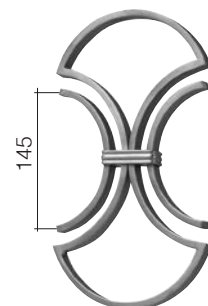

Art. GD187/2
 \varnothing 14 x 8 mm
 190 x 325 mm



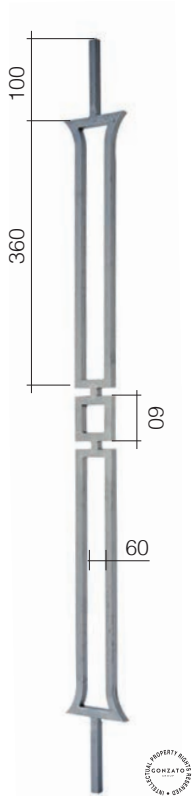

Art. GD78/4
Ø 12 mm
100 x 1000 mm

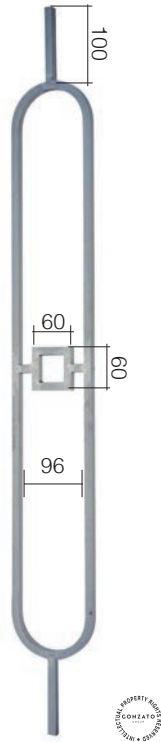

Art. GD78/6
Ø 12 mm
120 x 1000 mm



Art. 1084/3
Ø 12 x 12 mm
100 x 1000 mm



Art. 1084/4
Ø 12 x 12 mm
100 x 1000 mm

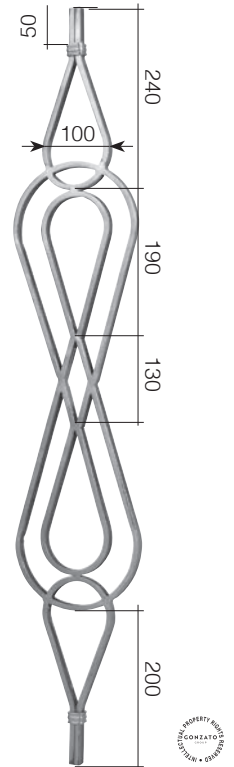

Art. GD171/1
Ø 14 x 8 mm
180 x 1000 mm

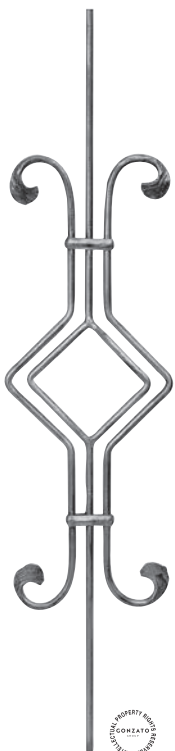

Art. 1074/1
Ø 10 mm
205 x 1000 mm

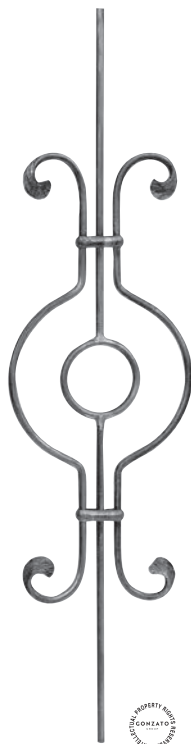

Art. 1074/2
Ø 10 mm
230 x 1000 mm

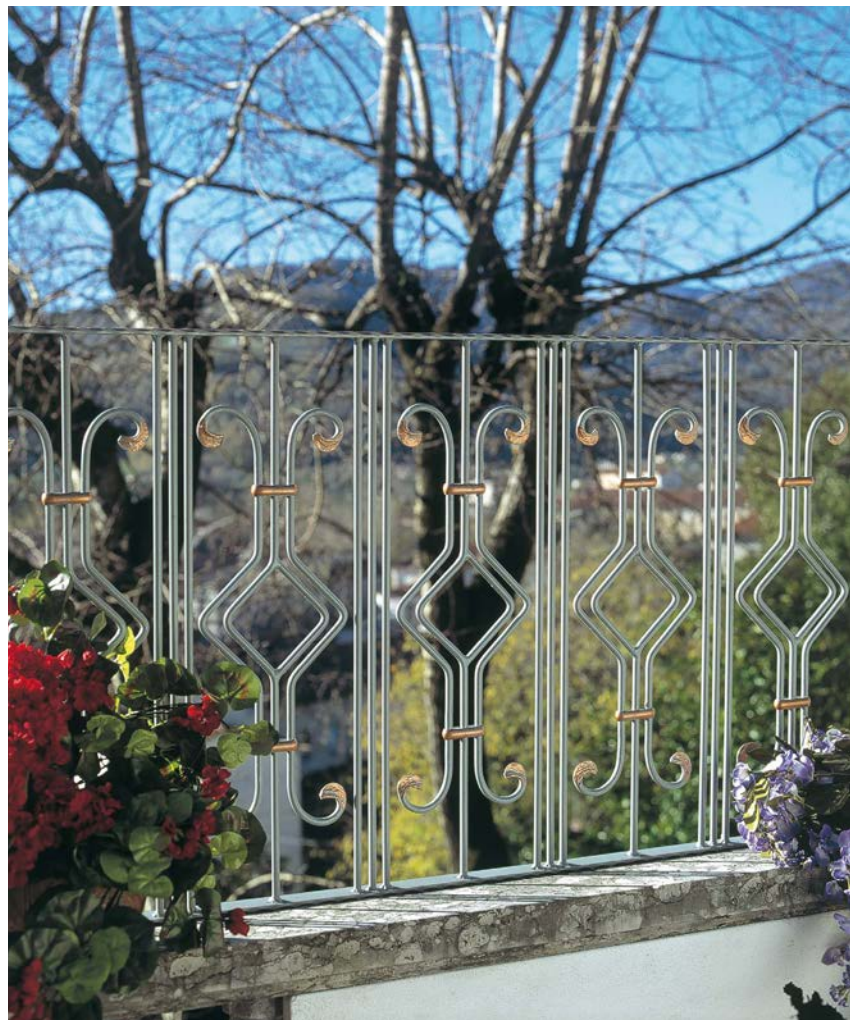

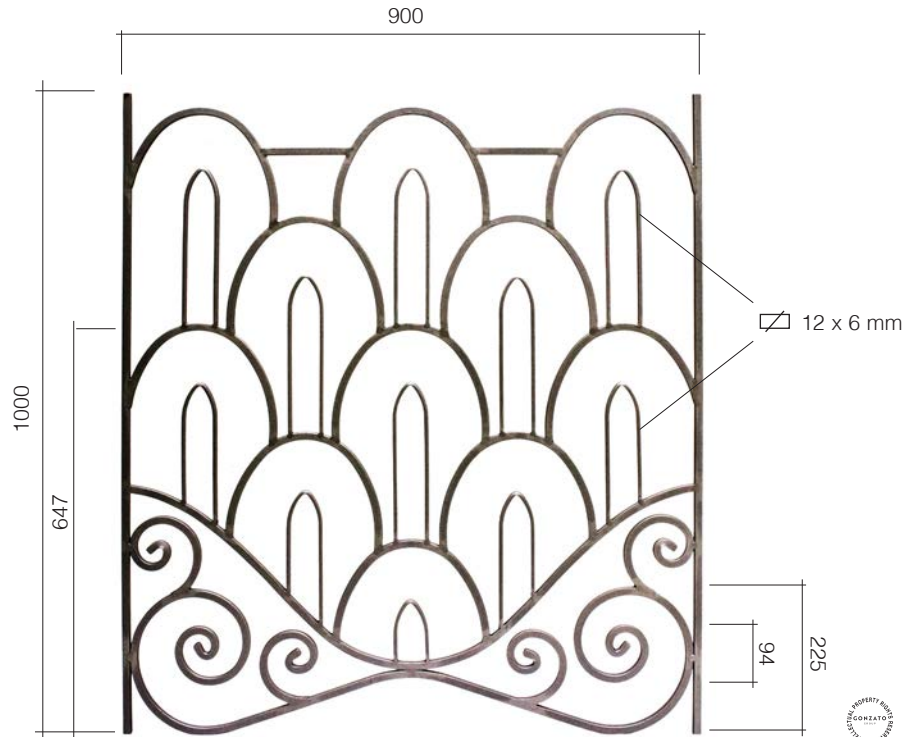

Art. GD291/1
 $\square 12 \times 12 \text{ mm} + \square 12 \times 6 \text{ mm}$
 900 x 1000 mm

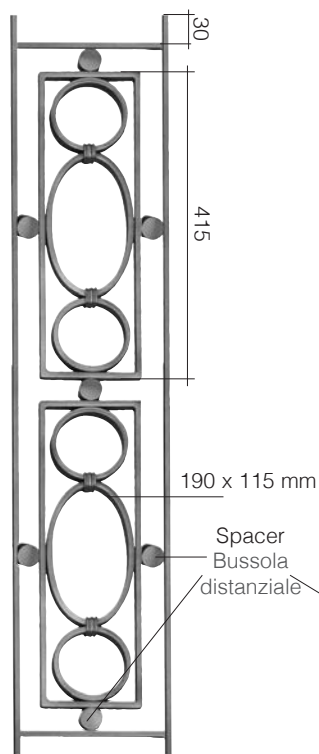

Art. GD205/2
 $\square 14 \times 8 \text{ mm}$
 210 x 1000 mm

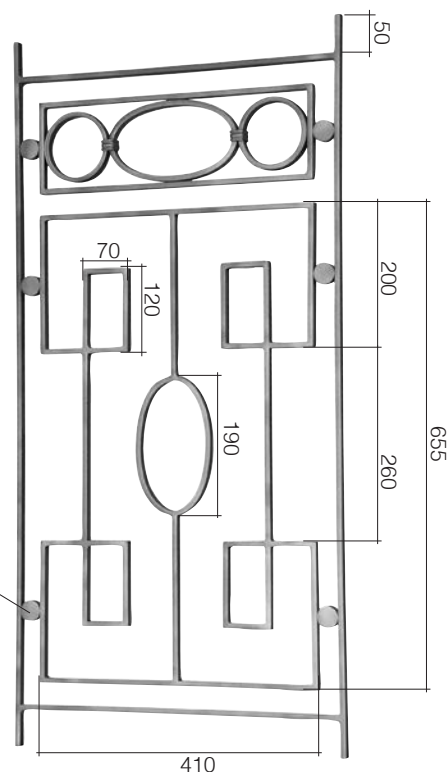

Art. GD205/1
 $\square 14 \times 8 \text{ mm}$
 495 x 1000 mm

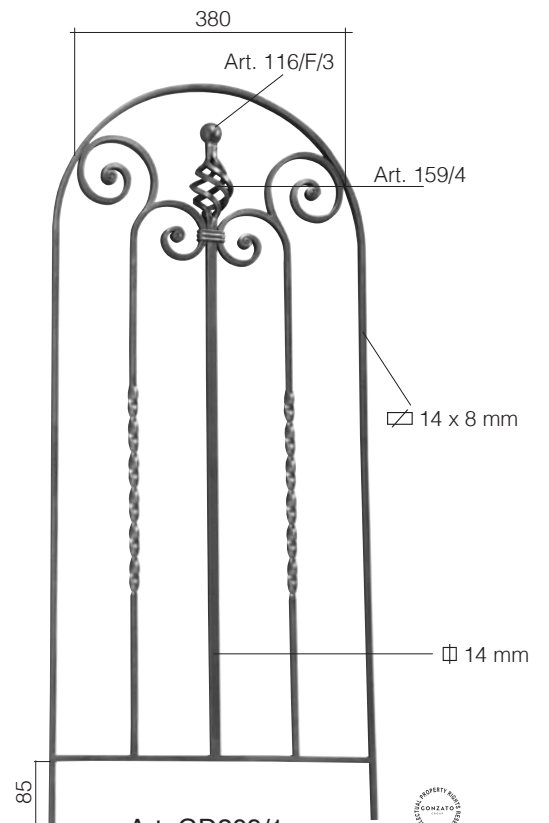

Art. GD209/1
 $\square 14 \times 8 \text{ mm}$
 440 x 1000 mm



Tubular steel frame \varnothing 25 x 25 mm - Insert iron solid \varnothing 12 x 12 mm
Struttura-telaio tubo \varnothing 25 x 25 mm - Inserti \varnothing 12 x 12 mm

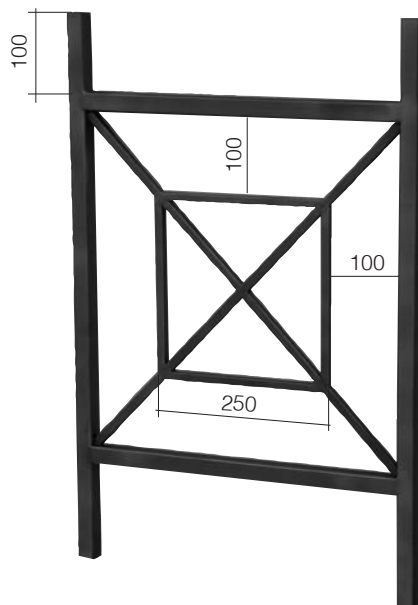

Art. GD76/2
H 700 mm
L 500 mm

Rosettes 116/A/4 on both sides - Rosette 116/A/4 sui 2 lati



Art. GD12/1
□ 14 x 8 mm
95 x 1000 mm

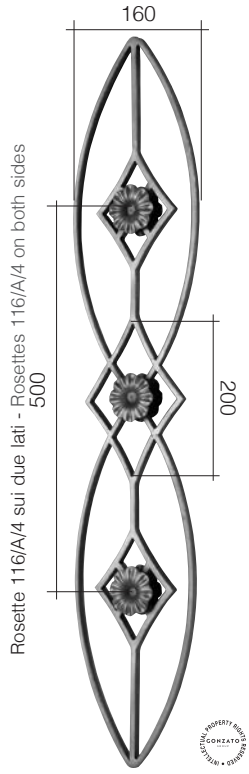

Art. GD15/1
□ 14 x 8 mm
190 x 1000 mm

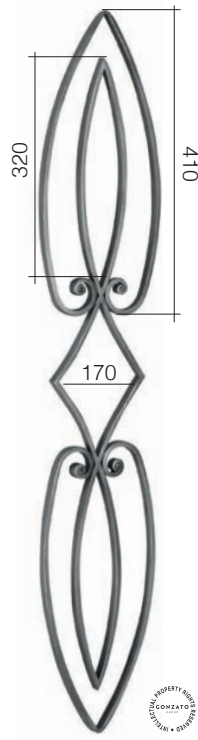

Art. GD15/2
□ 14 x 8 mm
190 x 1000 mm

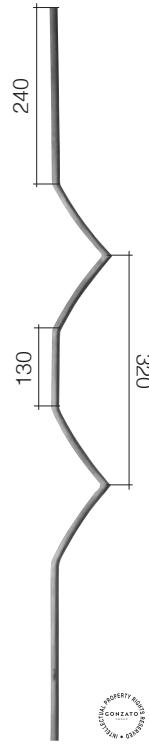

Art. GD18/3
□ 14 x 8 mm
85 x 1000 mm

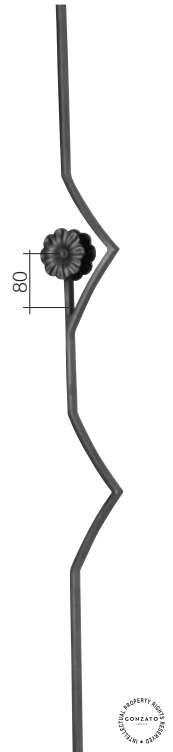

Art. GD18/4
□ 14 x 8 mm
115 x 1000 mm

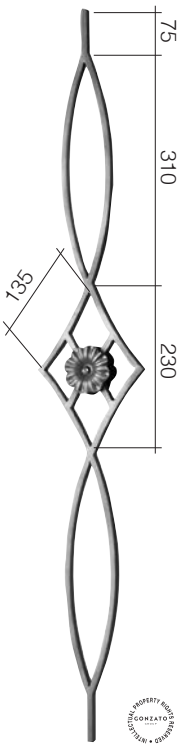

Art. GD16/2
□ 14 x 8 mm
160 x 1000 mm

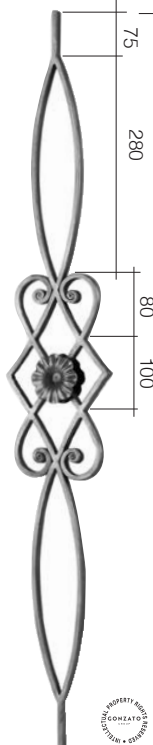

Art. GD16/1
□ 14 x 8 mm
160 x 1000 mm

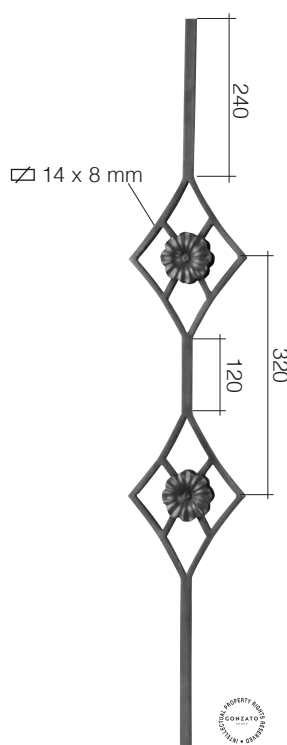

Art. GD18/1
□ 14 mm
160 x 1000 mm

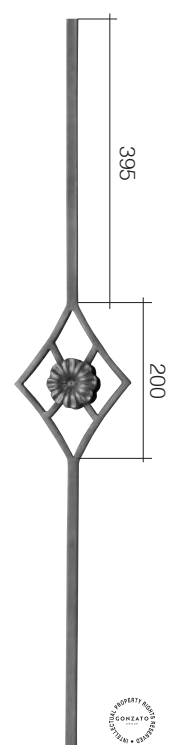

Art. GD18/2
□ 14 mm
160 x 1000 mm

Rosettes 116/A/4 on both sides - Rosette 116/A/4 sui 2 lati

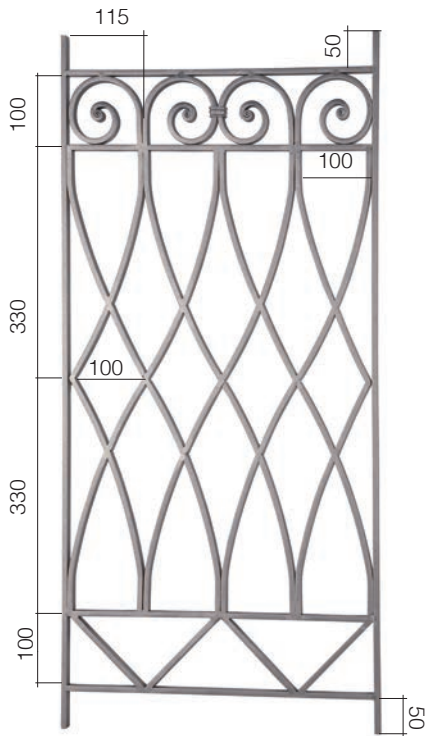

Art. GD283/1
 □ 14 x 8 mm
 480 x 1000 mm

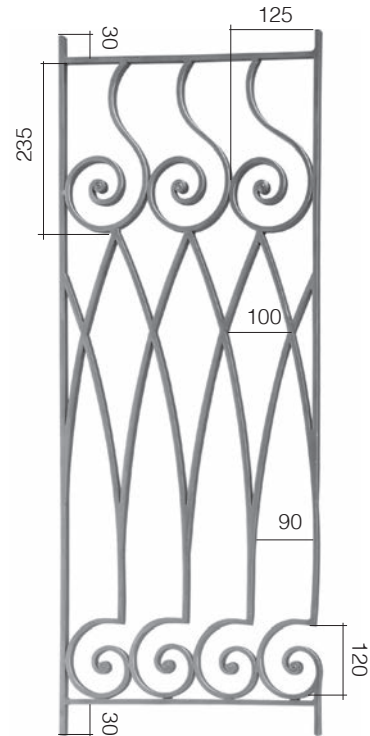

Art. GD220/2
 □ 14 x 8 mm
 395 x 1000 mm

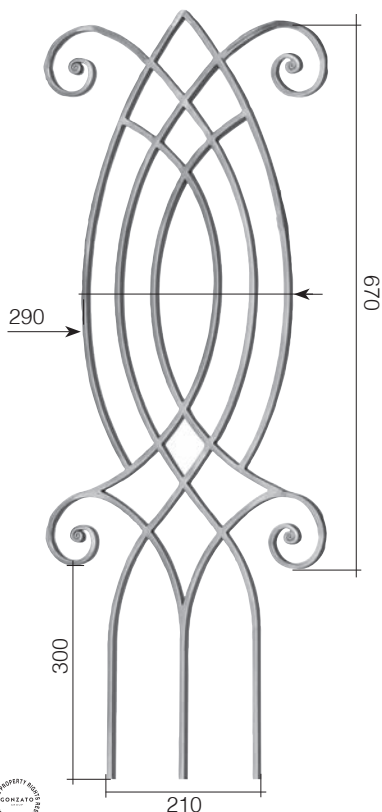

Art. GD234/1
 □ 14 x 8 mm
 380 x 1000 mm

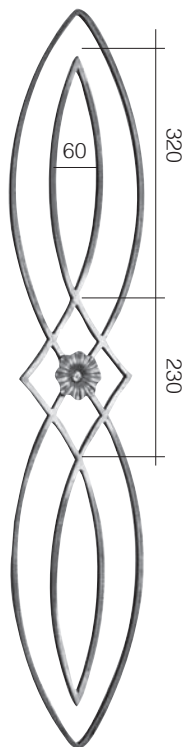

Art. 1680/2
 □ 14 x 8 mm
 190 x 1000 mm

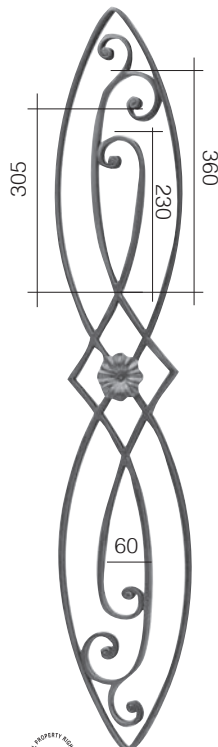

Art. 1681/1
 □ 14 x 8 mm
 190 x 1000 mm



Ornaments - Ornamenti $\square 12 \times 6 \text{ mm}$

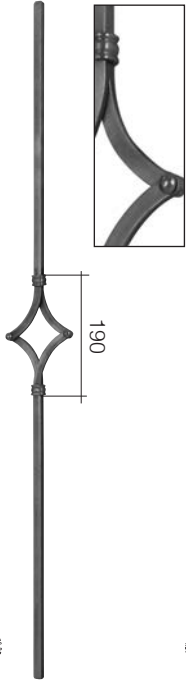

Art. GD20/1 **BEST PRICE**
 $\square 12 \text{ mm}$
110 x 1000 mm

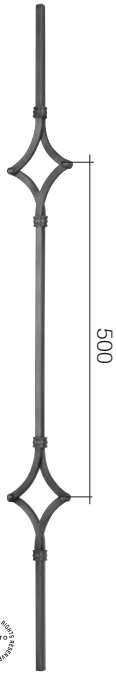

Art. GD20/2
 $\square 12 \text{ mm}$
110 x 1000 mm

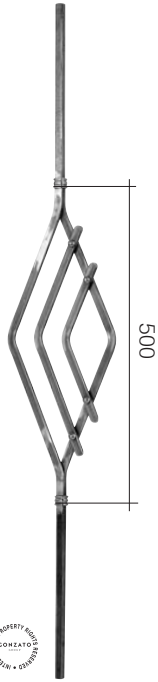

Art. GD20/3
 $\square 12 \text{ mm}$
180 x 1000 mm



Art. GD20/4
 $\square 12 \text{ mm}$
200 x 1000 mm

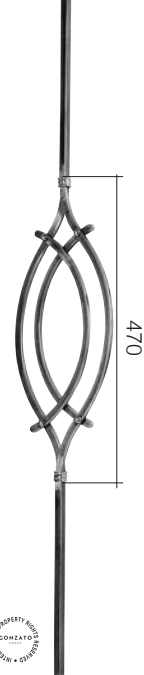

Art. GD20/5
 $\square 12 \text{ mm}$
180 x 1000 mm

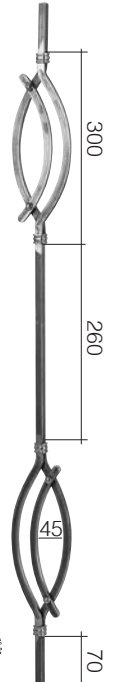

Art. GD20/6
 $\square 12 \text{ mm}$
100 x 1000 mm

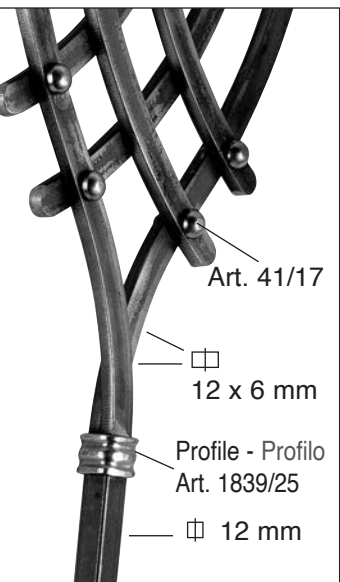

Art. GD20/7
 $\square 12 \text{ mm}$
100 x 1000 mm

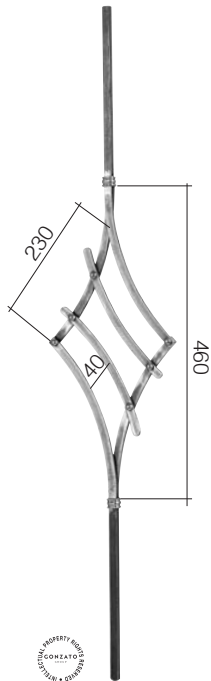

Art. GD20/8
 $\square 12 \text{ mm}$
200 x 1000 mm



Ornaments - Ornamenti \square 12 x 6 mm

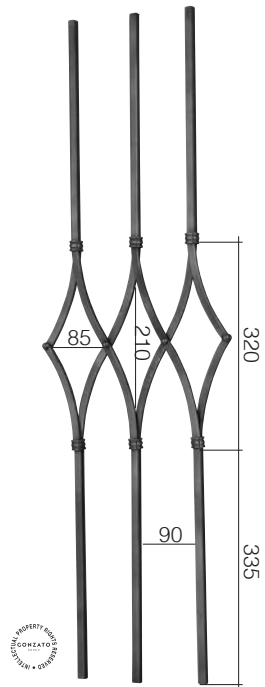

Art. GD21/1
 \square 12 mm
315 x 1000 mm

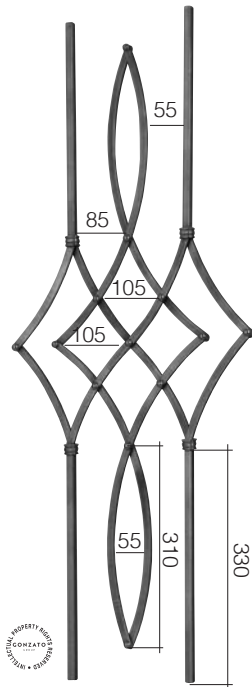

Art. GD21/2
 \square 12 mm
415 x 1000 mm

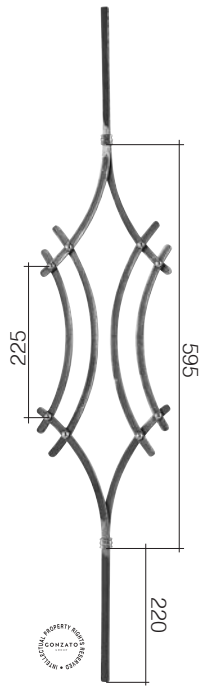

Art. GD21/3
 \square 12 mm
200 x 1000 mm

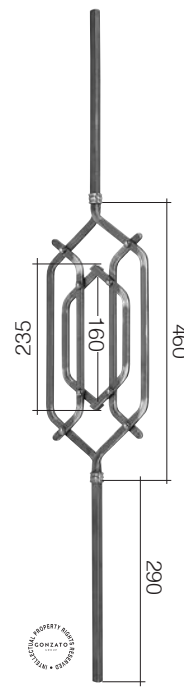

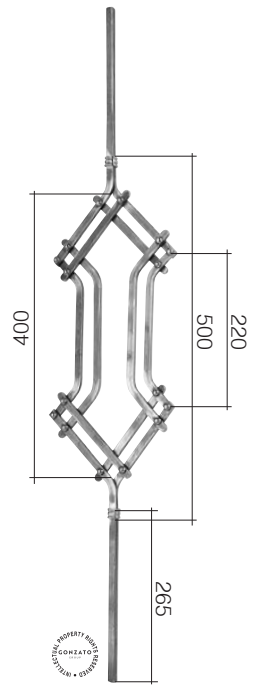

Art. GD21/4
 \square 12 mm
180 x 1000 mm



Art. GD21/5
 \square 12 mm
200 x 1000 mm

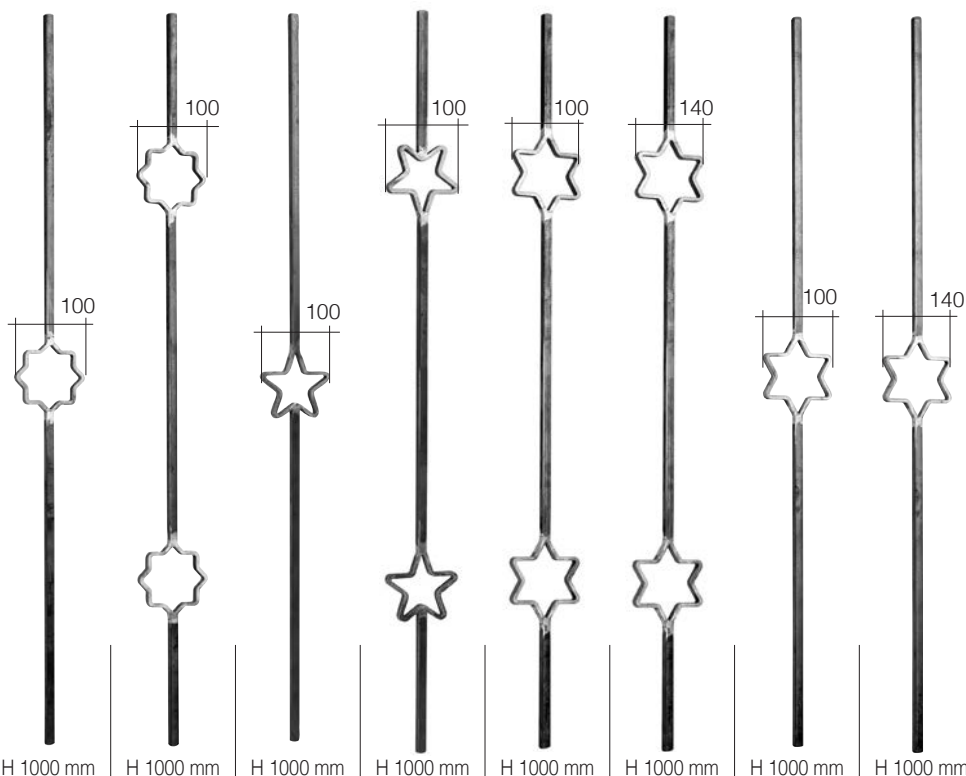



Sec.Sez.	Finish - Finitura	Art.	Art.	Art.	Art.	Art.	Art.	Art.	Art.
∅ 12 mm	Plain Liscio 	1325/3	1325/4	1325/5	1325/6	1325/8	1325/10	1325/7	1325/9



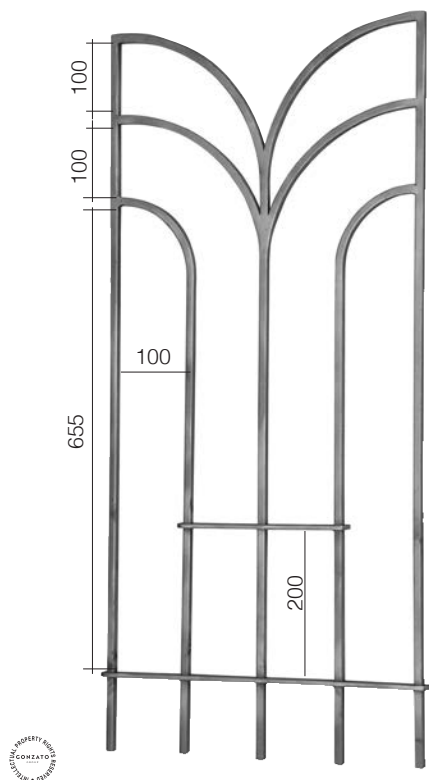

Art. GD68/1
 \square 12 x 12 mm
 480 x 1000 mm

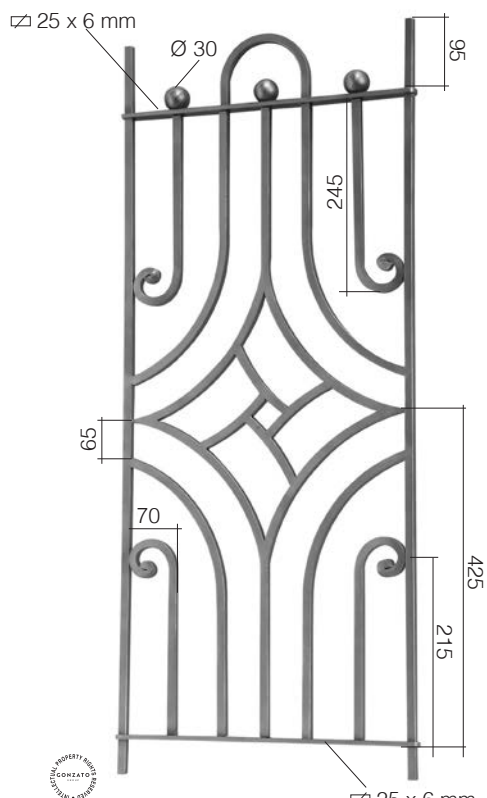

Art. GD212/1 \square 25 x 6 mm
 \square 12 x 12 mm
 420 x 1000 mm

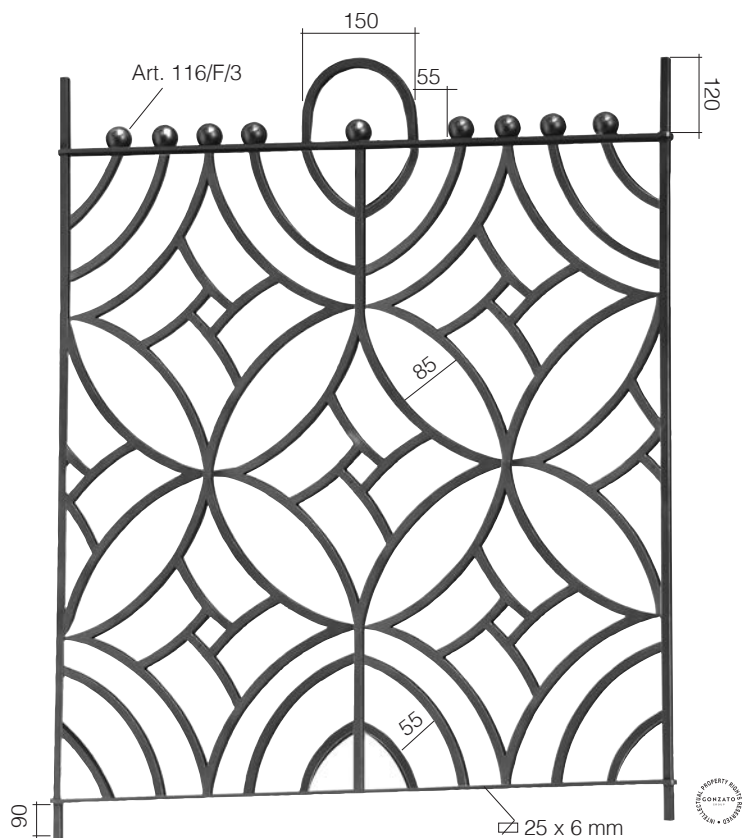

Art. GD211/1
 \square 12 x 12 mm
 830 x 1000 mm

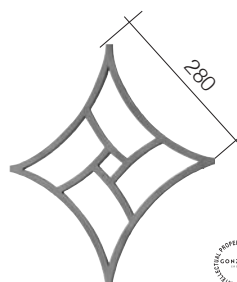

Art. GD211/2
 \square 12 mm
 395 x 395 mm



Art. GD211/3
 \square 12 mm
 395 x 1000 mm

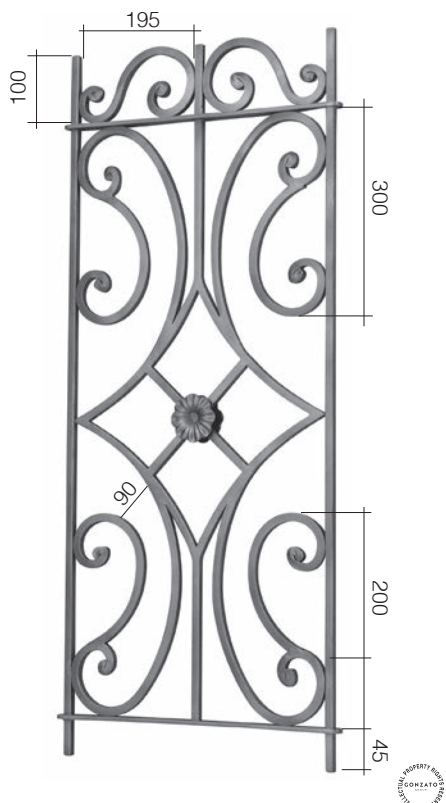

Art. GD61/1
Ø 12 x 12 mm
430 x 1000 mm

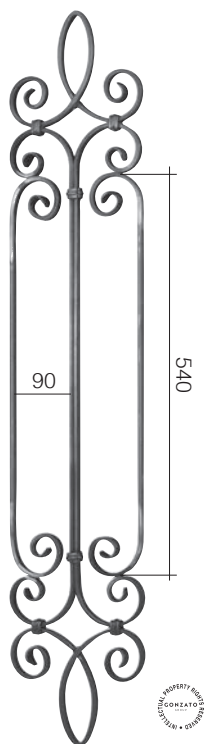

Art. GD35/2
Ø 12 x 6 mm
200 x 1000 mm

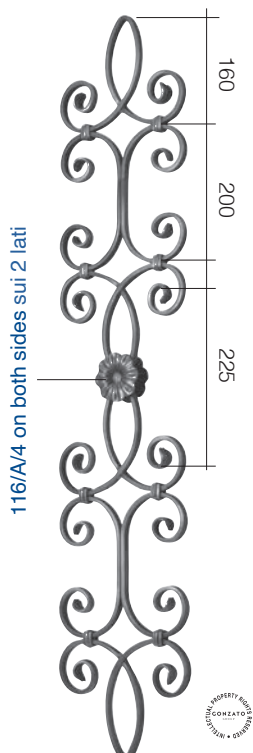

Art. GD35/1
Ø 12 x 6 mm
200 x 1000 mm

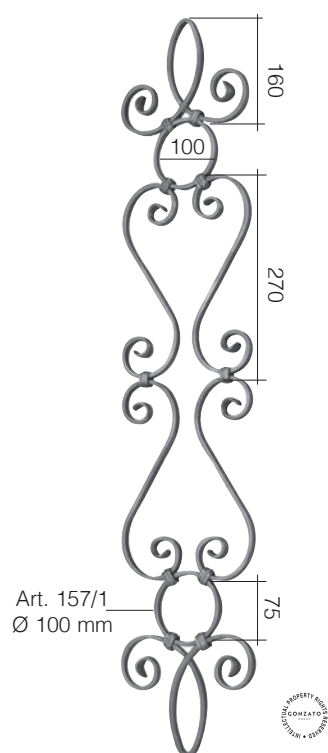

Art. GD35/3
Ø 12 x 6 mm
200 x 1000 mm

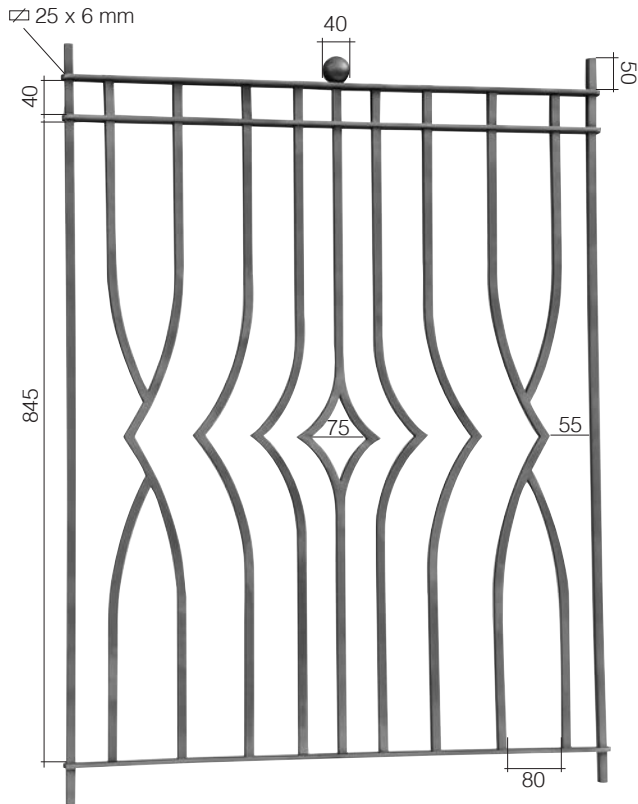

Art. GD232/1
 \varnothing 12 x 12 mm
 740 x 1000 mm

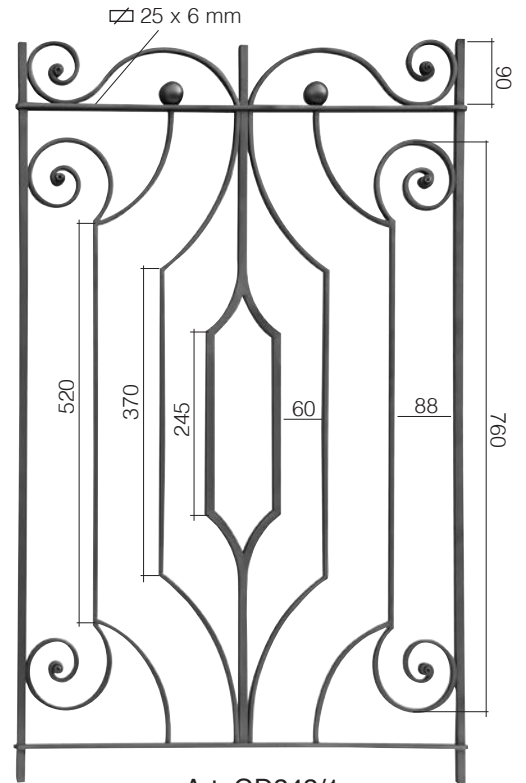

Art. GD242/1
 \varnothing 12 x 12 mm
 640 x 1000 mm



116/A/4 on both sides sui 2 lati

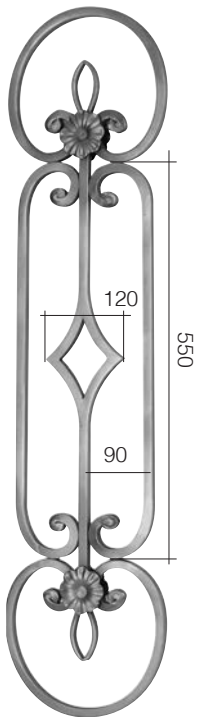

Art. GD31/1
 \varnothing 14 x 14 mm
 245 x 1000 mm

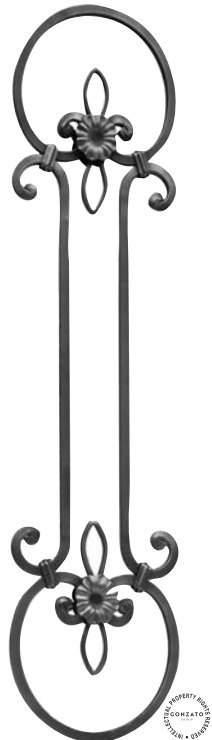

Art. 1682/1
 \varnothing 14 x 14 mm
 245 x 1000 mm

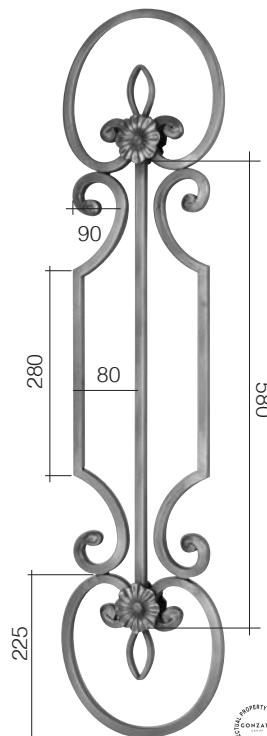

Art. GD31/2
 \varnothing 14 x 14 mm
 245 x 1000 mm



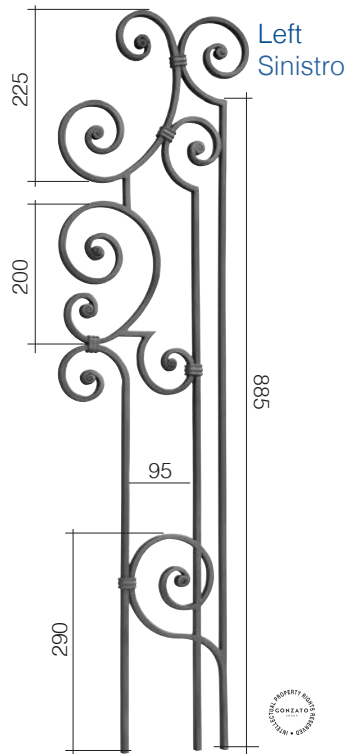

left - sinistro
Art. GD163/2
□ 14 x 8 mm
L 280 mm
H 1000 mm

right - destro
Art. GD163/1
□ 14 x 8 mm
L 280 mm
H 1000 mm

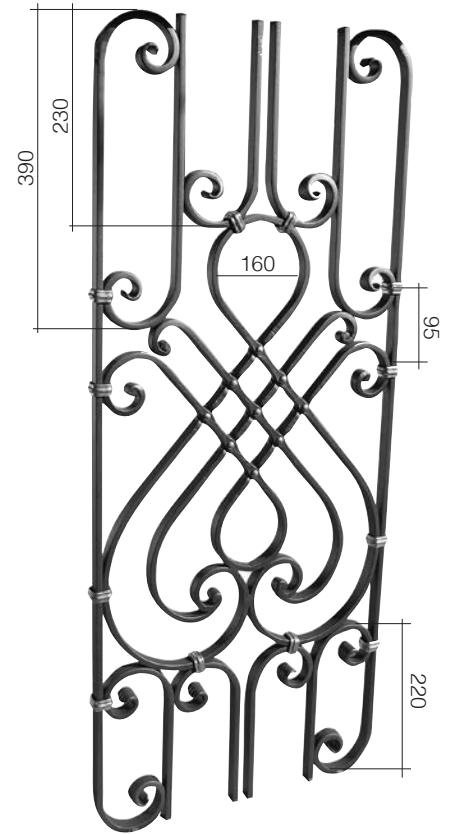

Art. GD99/1
□ 16 x 8 mm
420 x 1000 mm

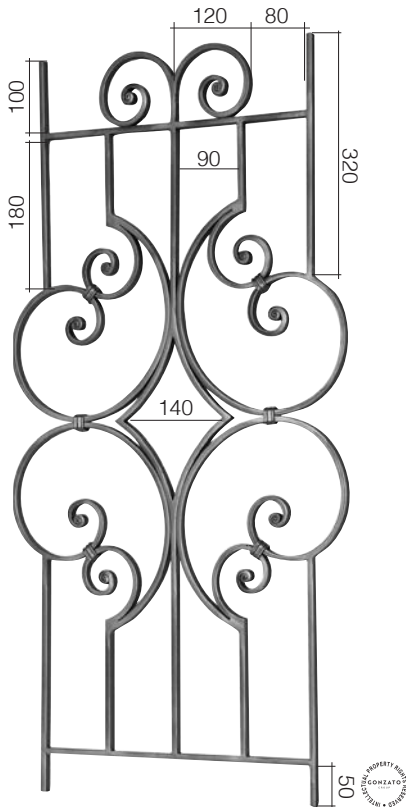

Art. GD219/1
□ 14 x 8 mm
500 x 1000 mm



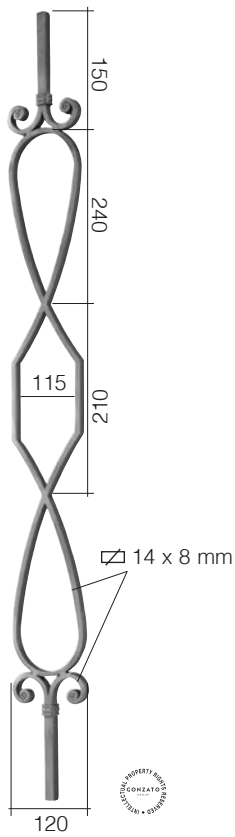

Art. GD178/1
□ 14 mm
120 x 1000 mm

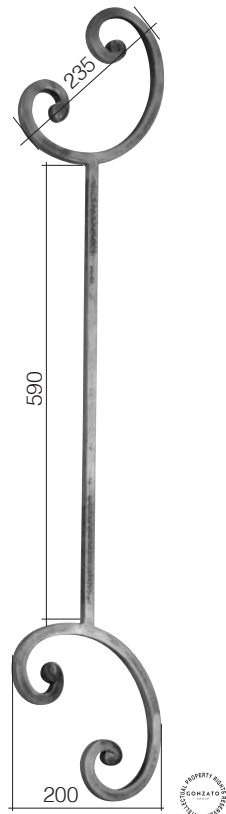

Art. GD22/5
□ 14 mm
200 x 1000 mm

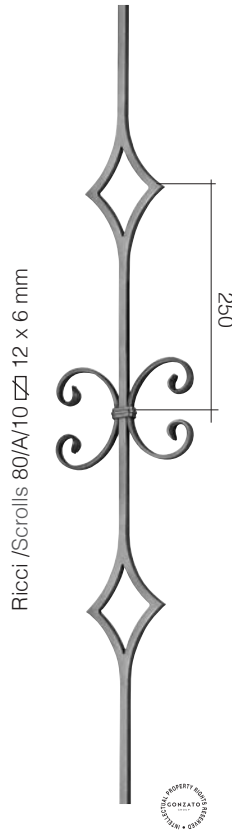

Art. GD59/3
□ 12 mm
200 x 1000 mm

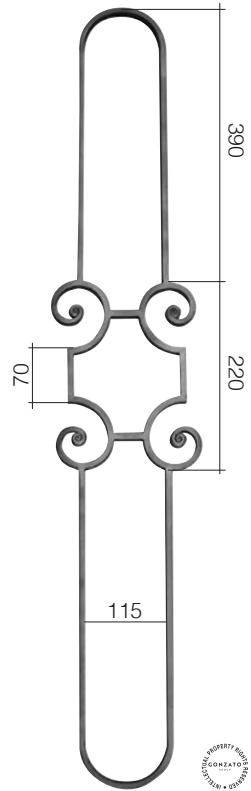

Art. GD245/3
□ 14 x 8 mm
180 x 1000 mm

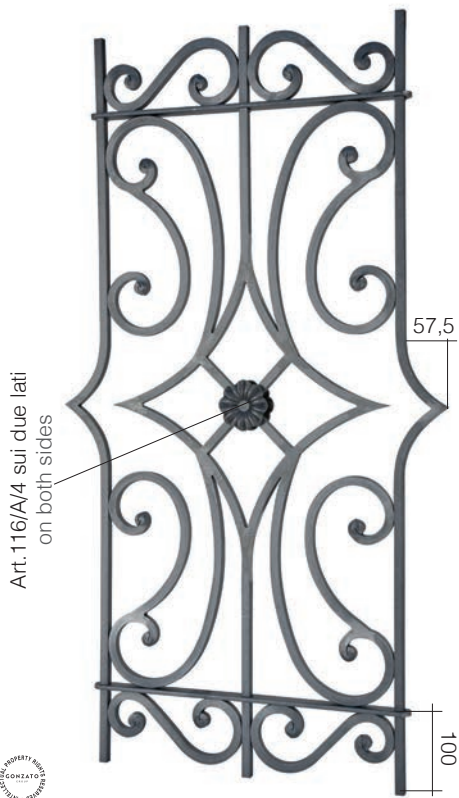

Art. GD61/3
□ 12 mm
515 x 1000 mm

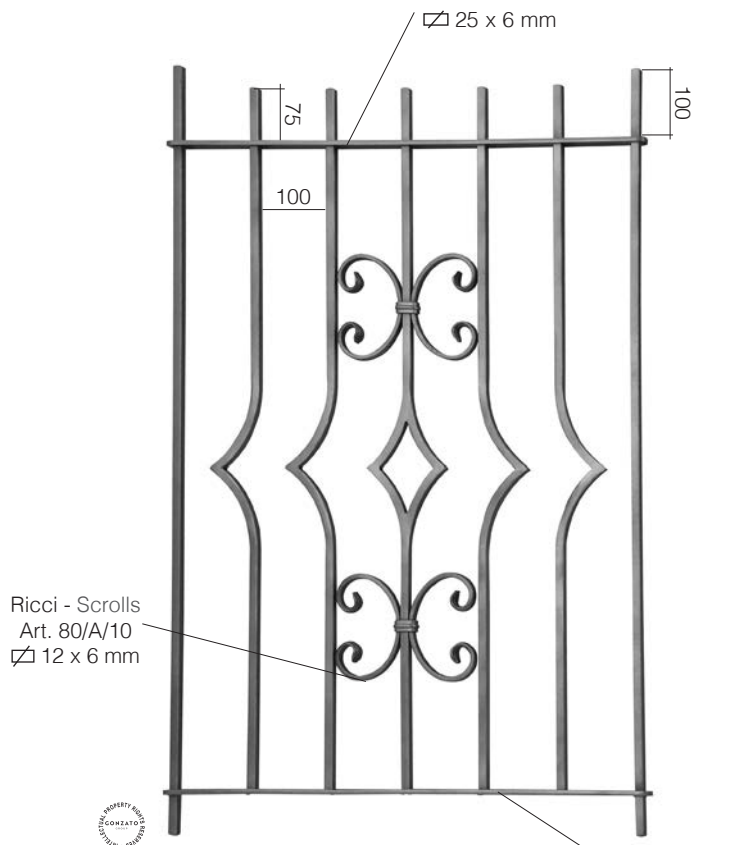

Art. GD58/1
□ 12 mm
685 x 1000 mm

Sfere/ Spheres Ø 25 mm
Art. 116/F/2

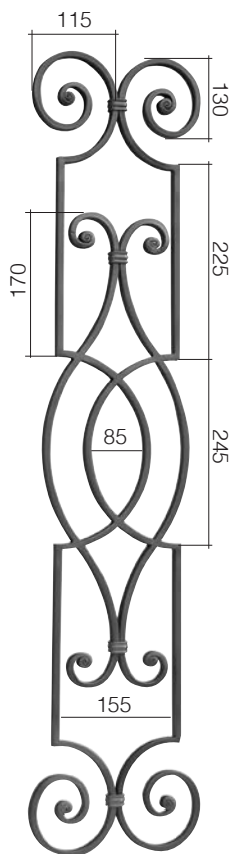

Art. GD173/1
14 x 8 mm
230 x 1000 mm

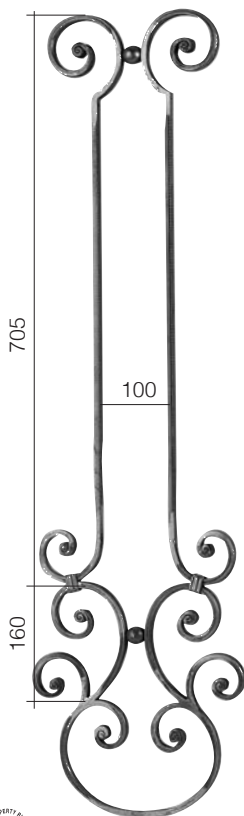

Art. GD159/1
14 x 8 mm
280 x 1000 mm

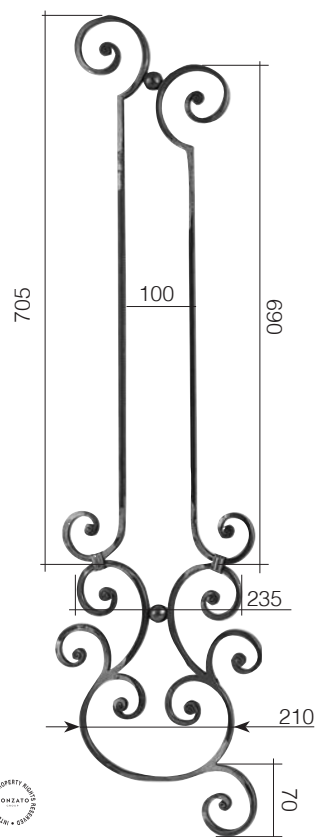

Art. GD159/2
14 x 8 mm
280 x 1000 mm





420
Art. GD216/1
□ 14 x 8 mm
470 x 1000 mm

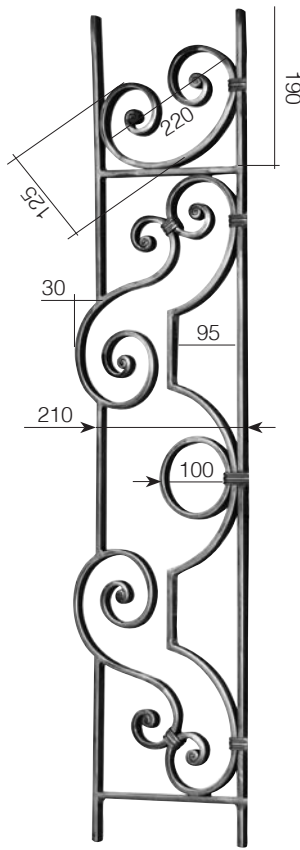

Art. GD216/2
□ 14 x 8 mm
240 x 1000 mm

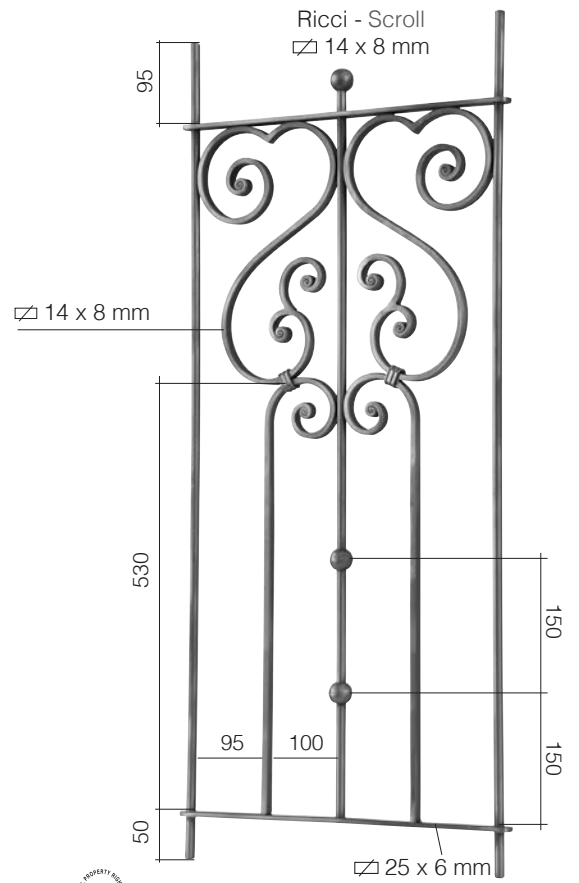

Art. GD241/1
Ø 12 mm
450 x 1000 mm

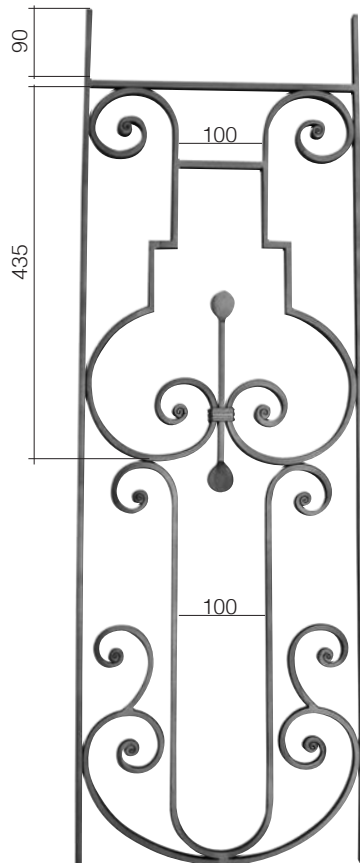

Art. GD245/1
□ 14 x 8 mm
330 x 1000 mm

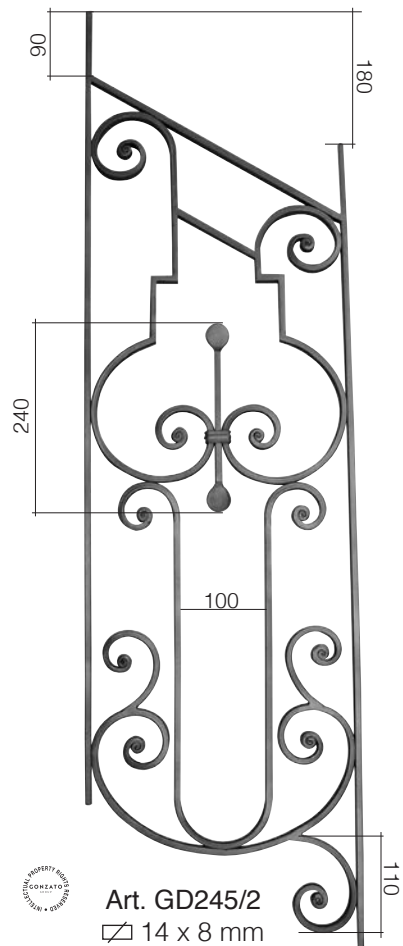

Art. GD245/2
□ 14 x 8 mm
330 x 1000 mm



Art. GD236/1
 □ 14 x 8 mm
 970 x 1000 mm

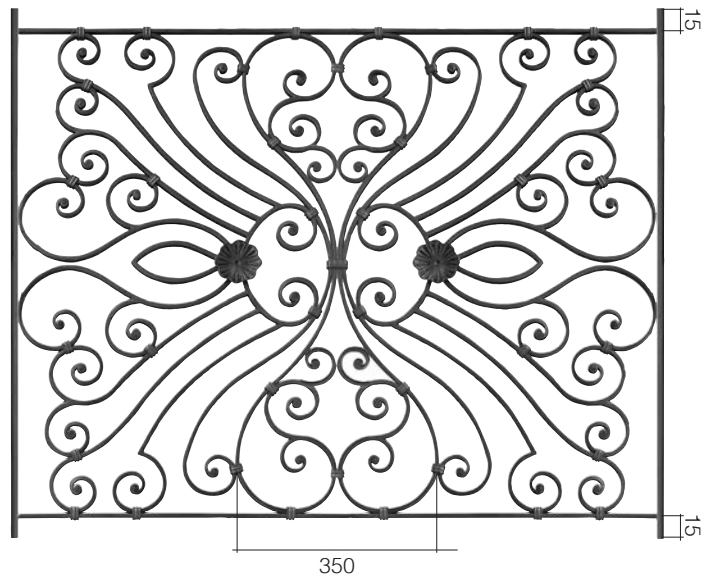

Art. GD239/1
 □ 14 x 8 mm
 1185 x 1000 mm



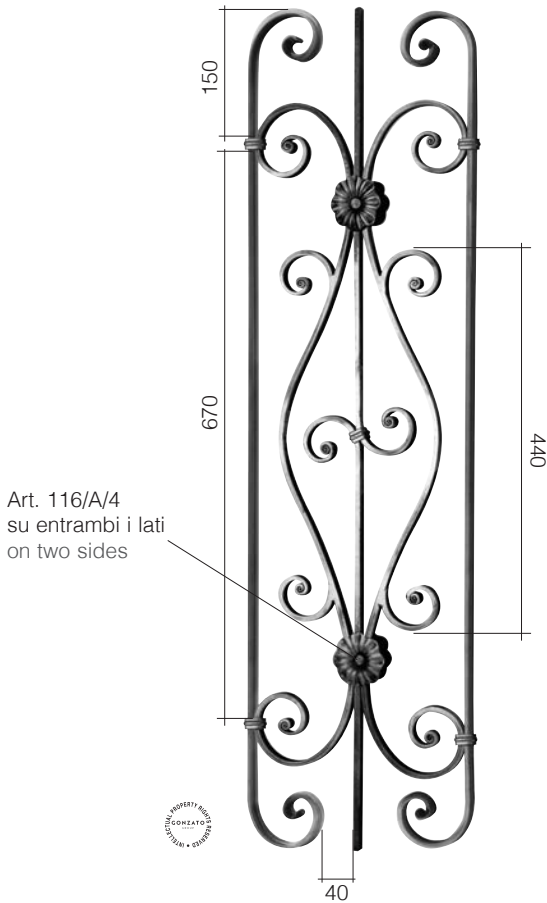

Art. GD105/1
□ 14 x 8 mm
275 x 1000 mm

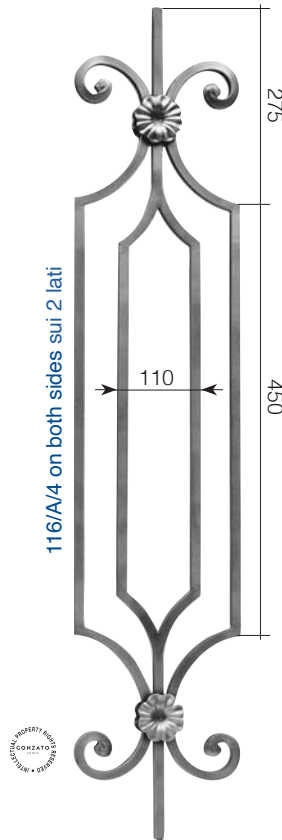

Art. 1685/3
□ 14 x 14 mm
230 x 1000 mm

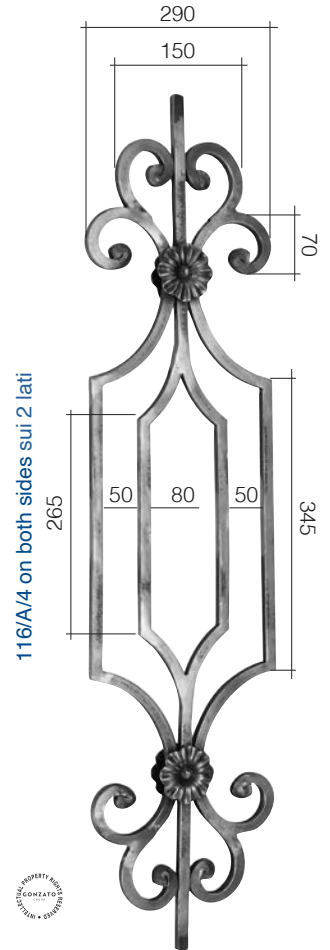

Art. GD22/1
□ 14 x 14 mm
230 x 1000 mm

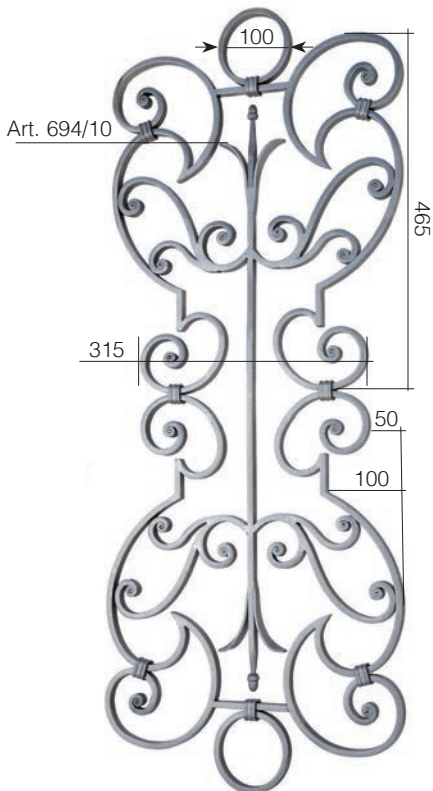

Art. GD282/2
□ 14 x 8 mm
405 x 1010 mm

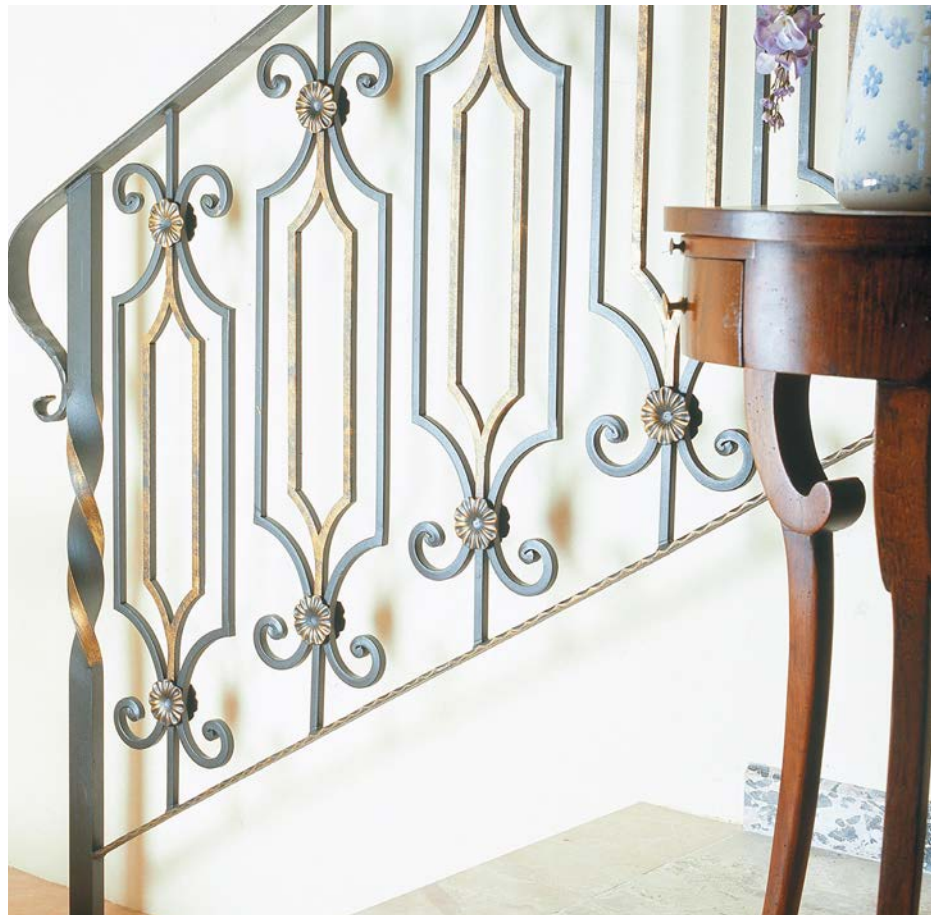

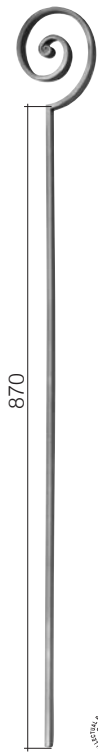

Art. GD175/4
 ▧ 14 x 8 mm
 115 x 1000 mm

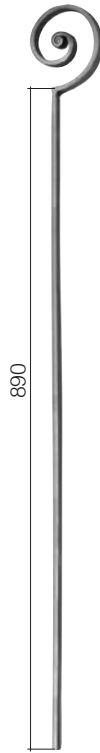

Art. GD175/5
 ▧ 14 x 8 mm
 105 x 1000 mm

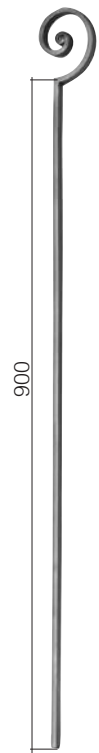

Art. GD175/6
 ▧ 14 x 8 mm
 85 x 1000 mm

BEST PRICE



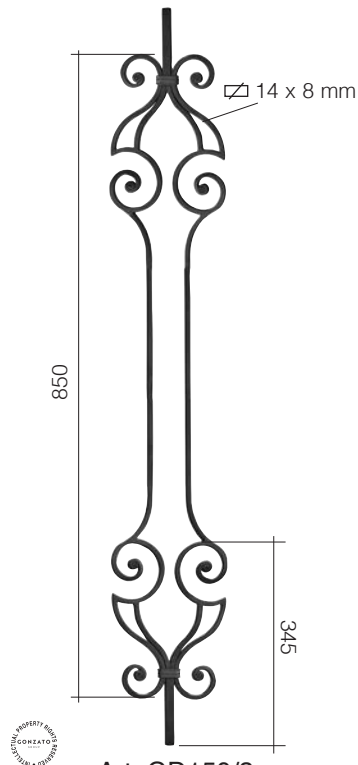

Art. GD150/2
Ø 14 x 14 mm
205 x 1000 mm

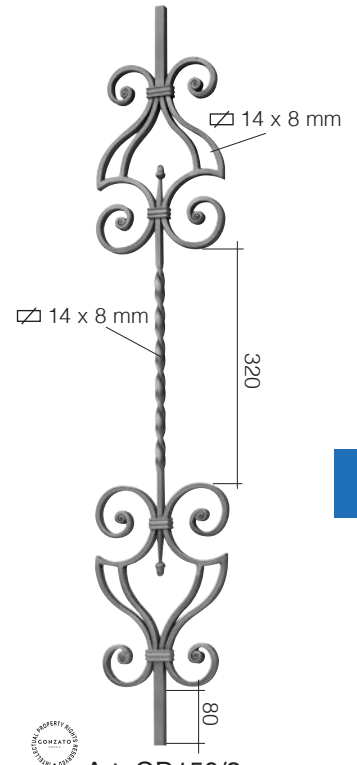

Art. GD150/3
Ø 14 x 14 mm
205 x 1000 mm

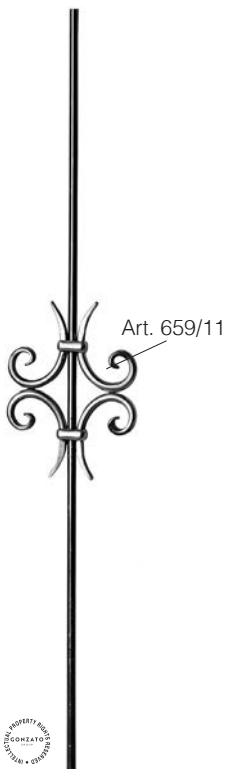

Art. 1066/5
Ø 12 mm
180 x 1000 mm

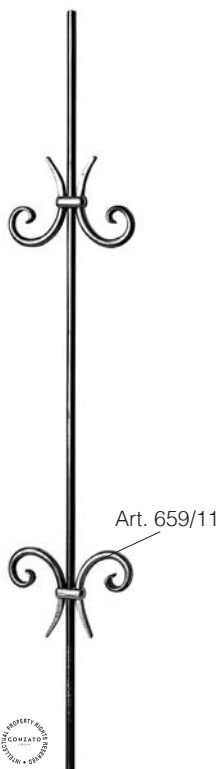

Art. 1066/4
Ø 12 mm
180 x 1000 mm

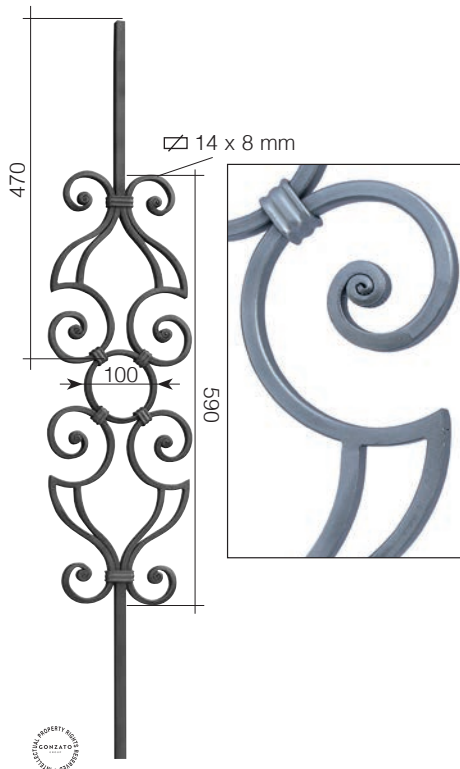

Art. GD151/1
Ø 14 x 14 mm
205 x 1000 mm

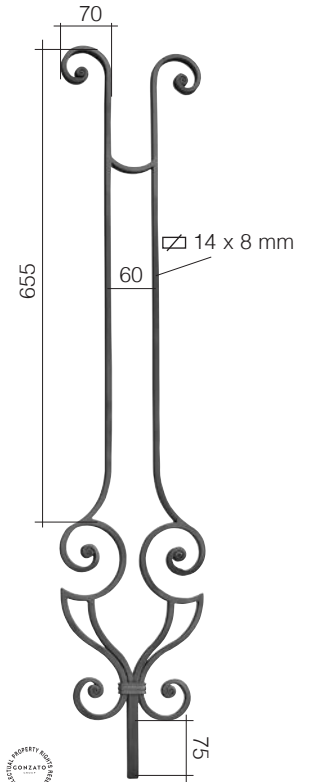

Art. GD148/1
Ø 14 x 14 mm
205 x 1000 mm

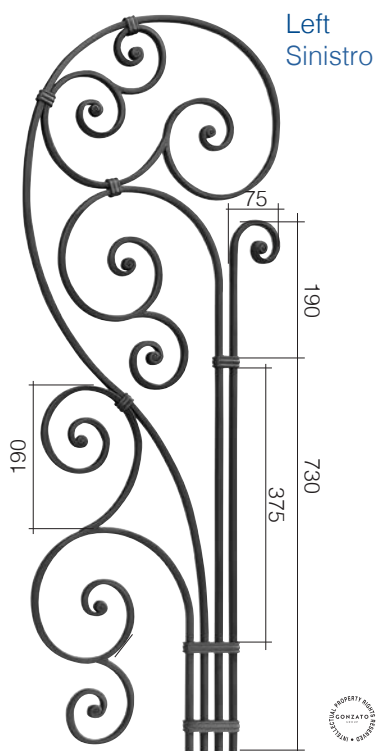

Left
Sinistro

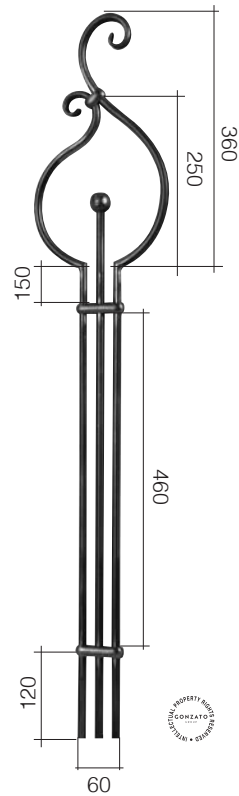
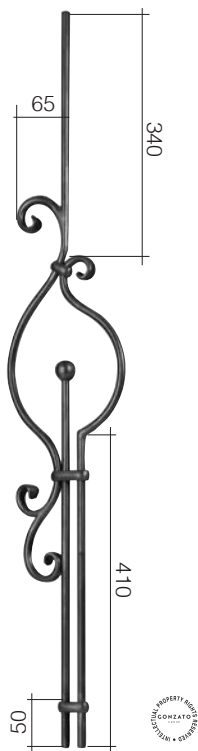

Sfere vuote Ø 30 mm
Hollow spheres Ø 30 mm

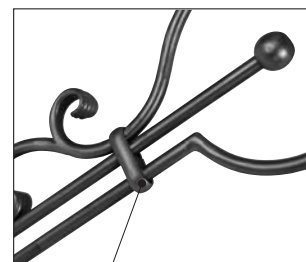

profilo/profile
art. 158/6

left - sinistro right - destro
Art. GD164/1 Art. GD164/2
14 x 8 mm 14 x 8 mm
380 x 1000 mm 380 x 1000 mm

Art. GD39/3
Ø 12 mm
190 x 1000 mm

Art. GD39/1
Ø 12 mm
200 x 1000 mm

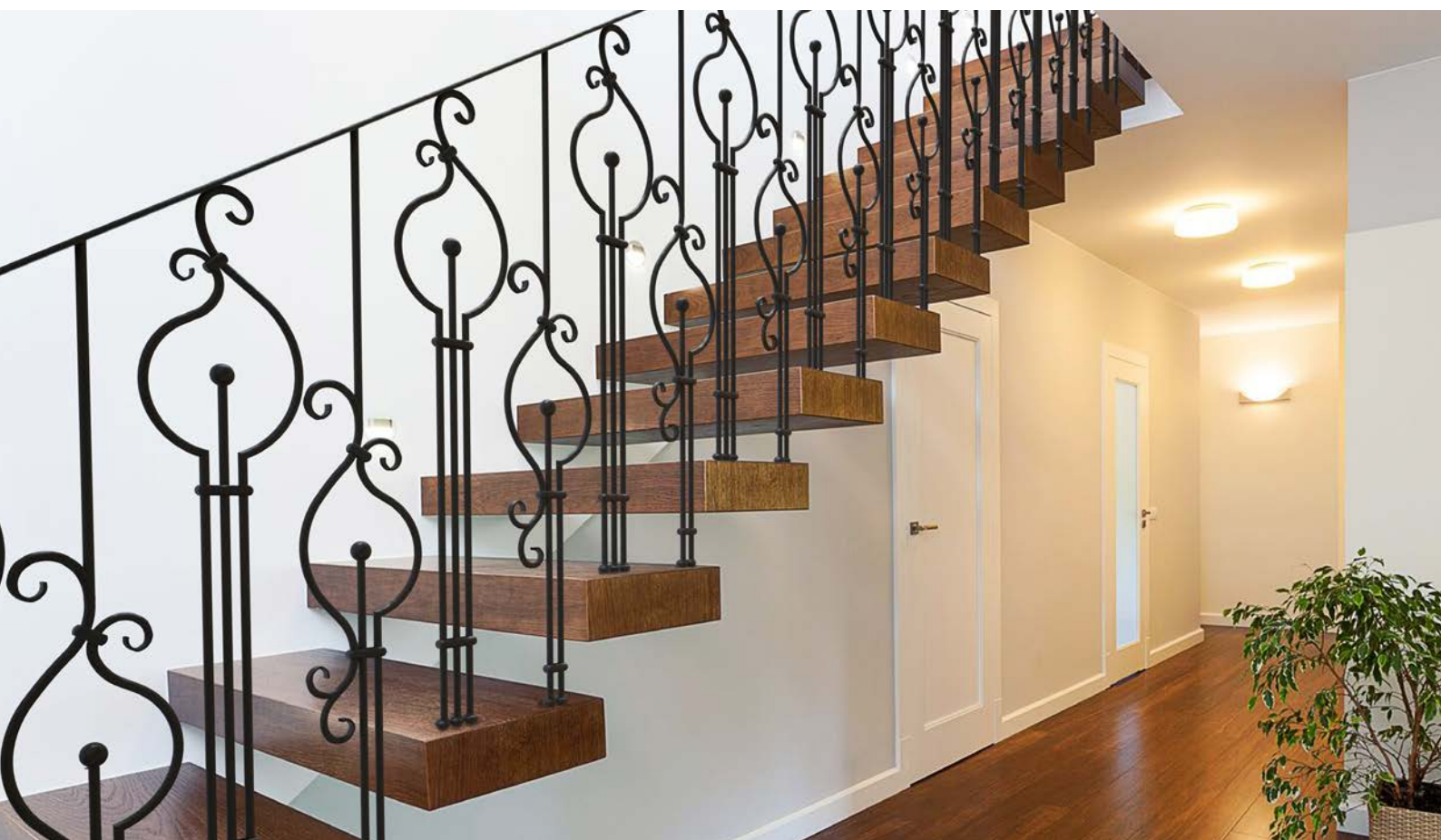

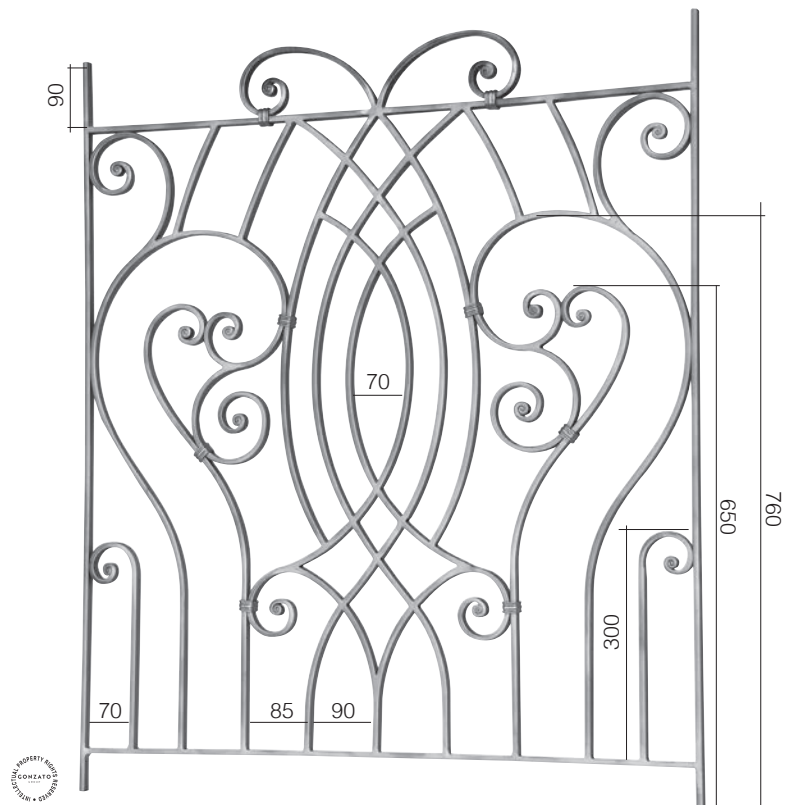
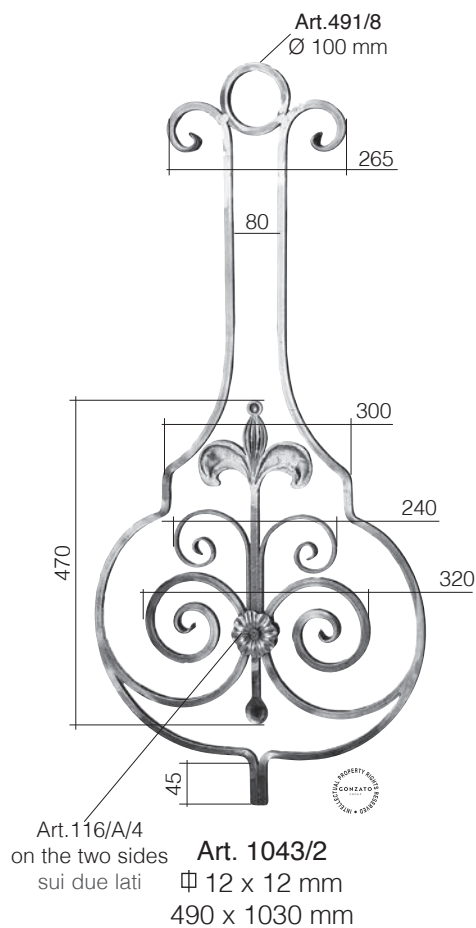

Art. GD235/1
14 x 8 mm
890 x 1000 mm

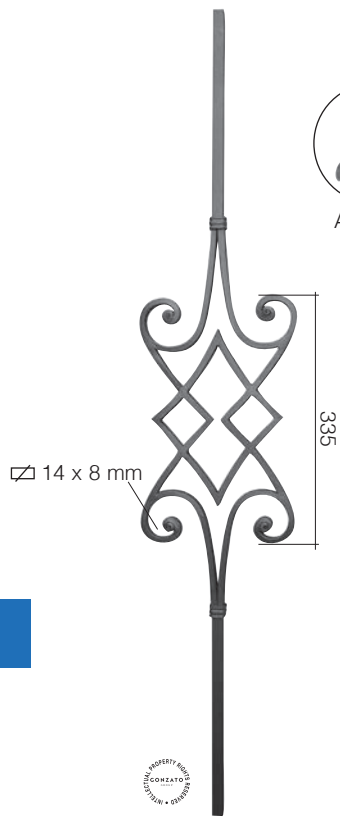

Art. GD154/3
∅ 14 mm
190 x 1000 mm



Art. GD158/1
∅ 14 x 8 mm
160 x 1000 mm

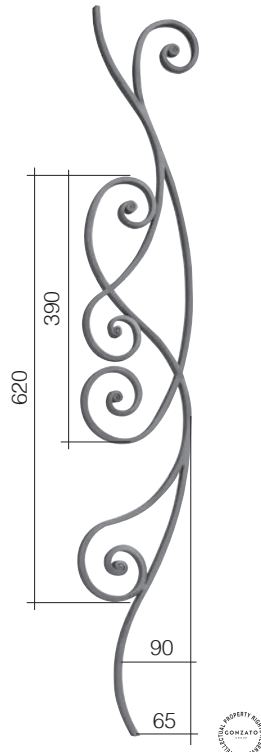

Art. GD158/2
∅ 14 x 8 mm
160 x 1000 mm

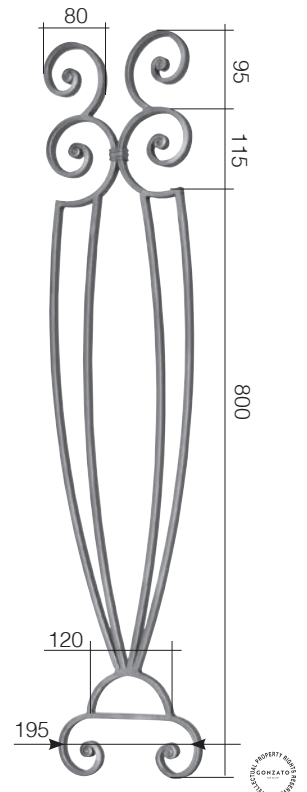

Art. GD175/7
∅ 14 x 8 mm
200 x 1000 mm



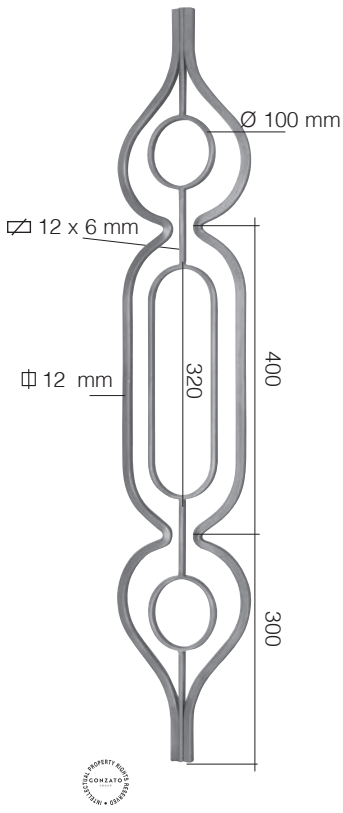

Art. GD69/1
Ø 12 mm
210 x 1000 mm

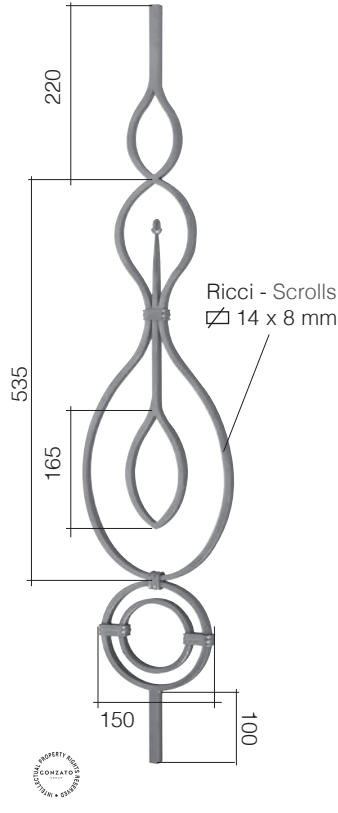

Art. GD177/1
Ø 14 mm
205 x 1000 mm

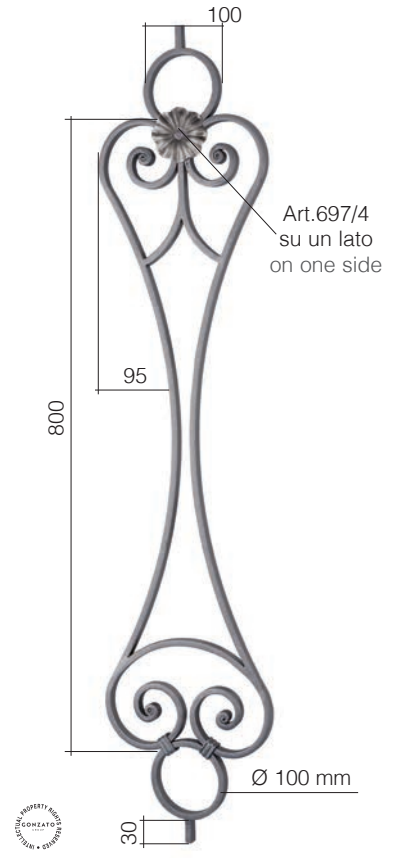

Art. GD280/2
Ø 14 x 8 mm
225 x 1000 mm

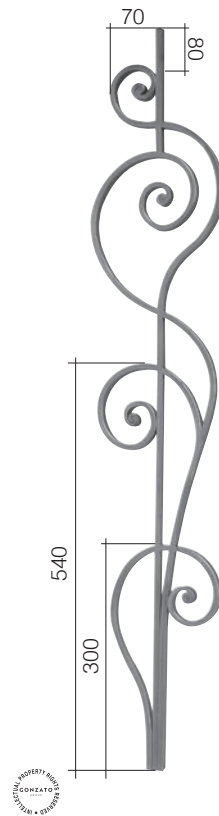

Art. GD228/2
Ø 14 x 8 mm
190 x 1000 mm

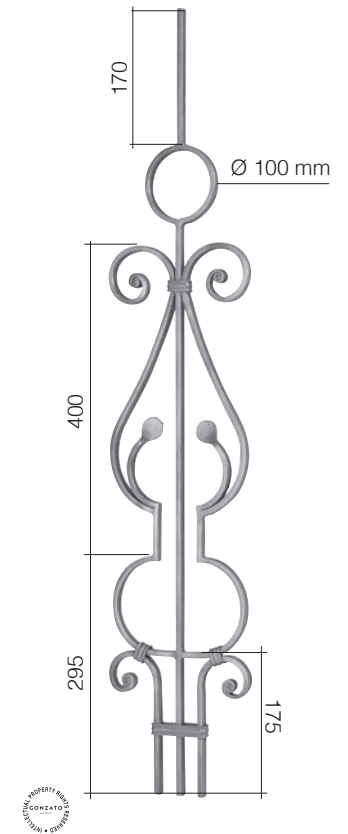

Art. GD166/2
Ø 14 x 8 mm
200 x 1000 mm

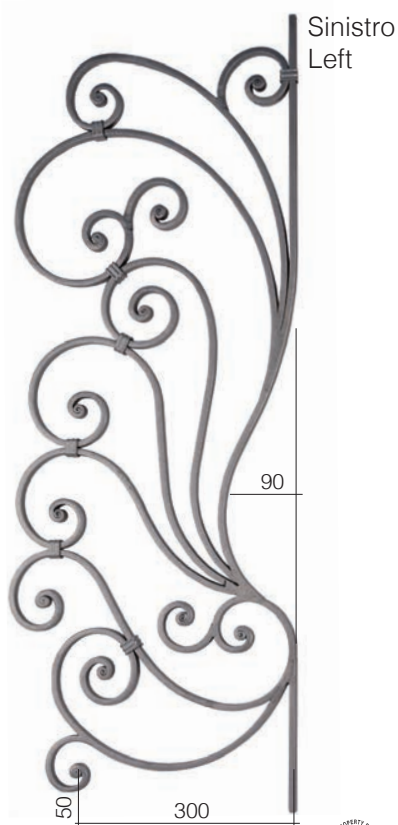

left - sinistro
Art. GD283/2
14 x 8 mm
380 x 1000 mm

right - destro
Art. GD283/4
14 x 8 mm

Rosetta 116/A/4/S1 sui 2 lati
con brocca 697/5 saldata
Rosetta 116/A/4/S1 on two sides
with 697/5 welded pitcher



Art. GD282/1
14 x 8 mm
490 x 1000 mm

Rosetta 116/A/4/S1 sui 2 lati
con brocca 697/5 saldata
Rosetta 116/A/4/S1 on two sides
with 697/5 welded pitcher



Art. GD284/2
14 x 8 mm
400 x 885 mm

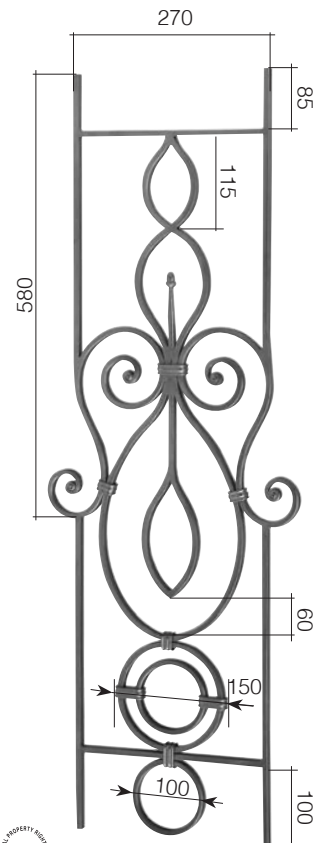

Art. GD177/2
14 x 8 mm
350 x 1000 mm

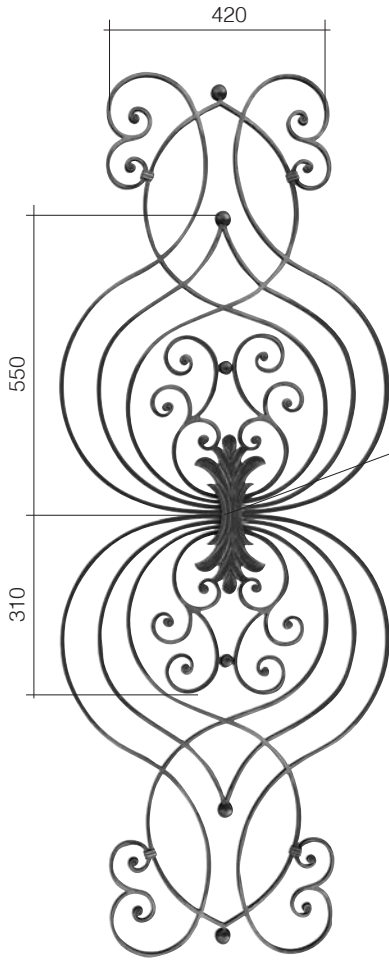

Art. GD231/1
14 x 8 mm
600 x 1600 mm



Ø 30 mm
art. 116/F/3
art. NEW0050
sui due lati
on both sides

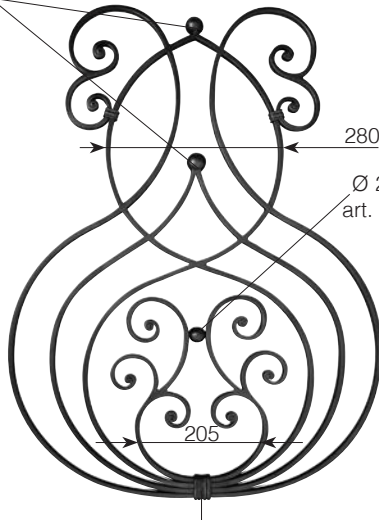

Ricci - Scrolls
14 x 8 mm

Art. GD231/2
14 x 8 mm
600 x 800 mm



profilo/profile
art. 158/49



Art. GD206/1
14 x 8 mm
420 x 1000 mm

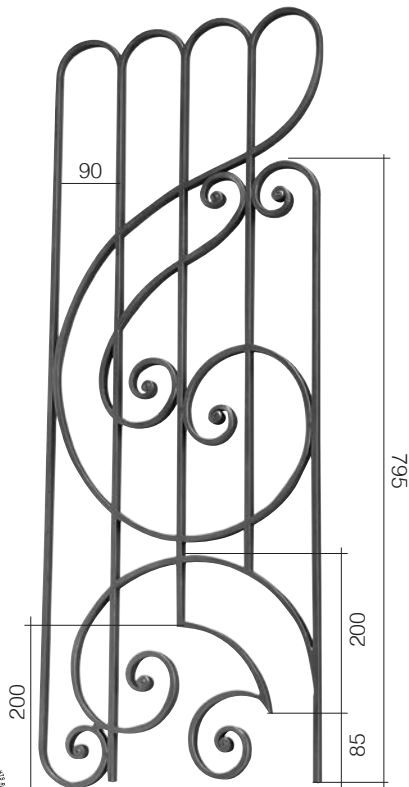

Art. GD225/1
14 x 8 mm
385 x 1000 mm



Scrolls - Ricci
16 x 6 mm

Art. GD239/4
on both sides
su 2 latii lati

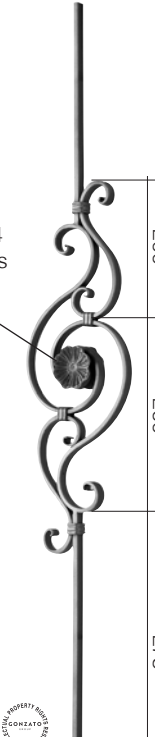

Art. GD271/5
16 x 8 mm
175 x 1000 mm



Art. GD239/4
su entrambi i lati
on two sides

Ricci - Scrolls
16 x 6 mm

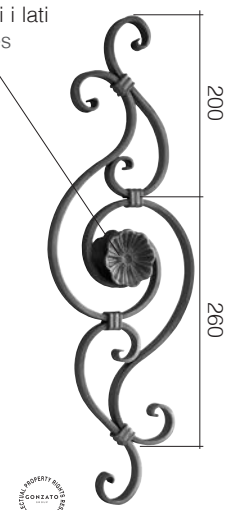

Art. GD271/4
16 x 6 mm
175 x 510 mm





Bowed pickets

Pancioni

Arteferro bowed pickets are elegant elements that allow you to create railings, fences or curved balustrated. Also made with patterns that reflect those of the pickets and panels, they can therefore be combined with each other to create compositions of refined elegance.

I pancioni Arteferro sono degli eleganti elementi che consentono di creare inferriate, recinzioni o parapetti bombati. Realizzati anche con motivi che riprendono quelli dei paletti e dei pannelli, possono quindi essere abbinati tra loro per realizzare composizioni dalla ricercata eleganza.

arteferro



FORGED - FORGIATI

Pag.
78

See also
forged pickets

Vedi anche
i paletti forgiati

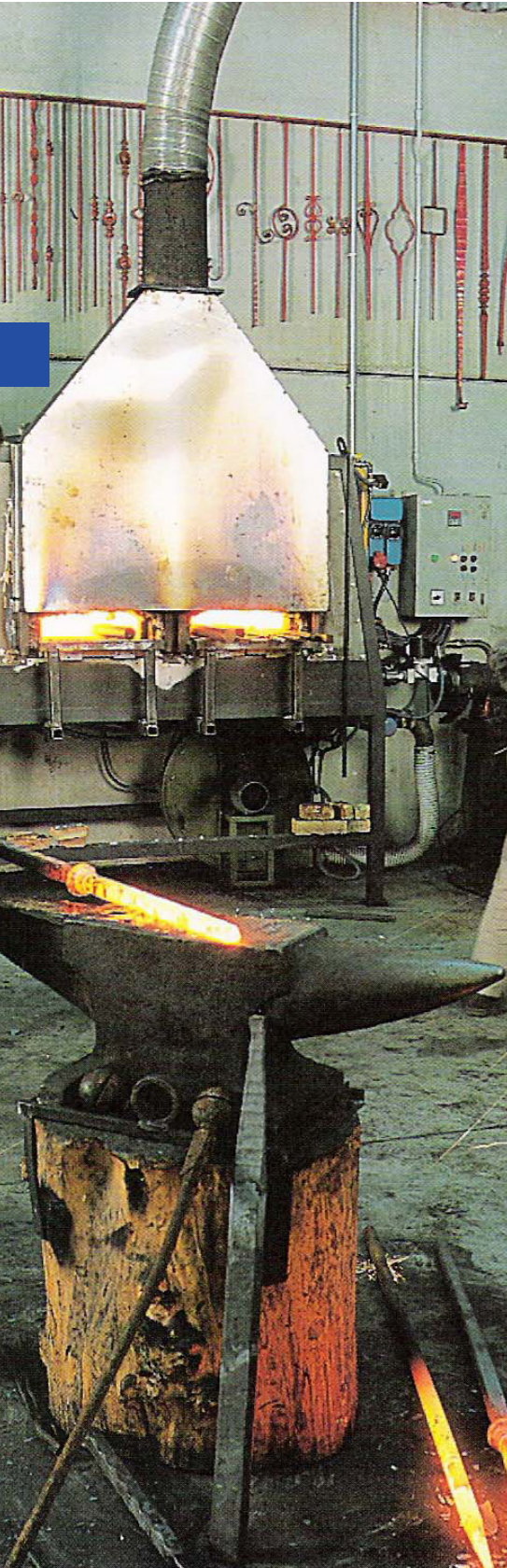

Art. 1783/1
Ø 14 x 14 mm
H 1000 mm



Art. 1783/2
Ø 14 x 14 mm
H 1000 mm

tapered - rastremato

180 mm



Art. 1783/5
Ø 12 x 12 mm
H 1000 mm

190 mm

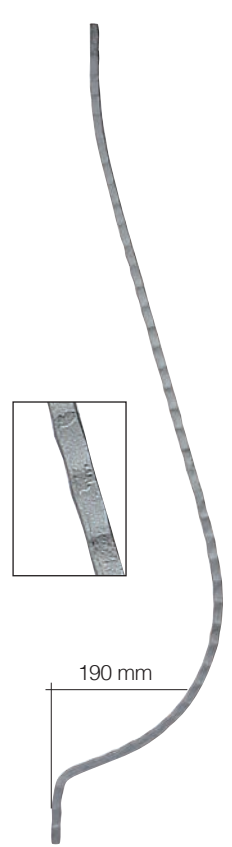

Art. 1783/6
Ø 12 x 12 mm
H 1000 mm

190 mm

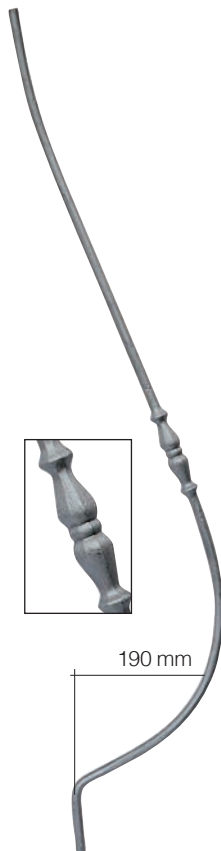

Art. 1783/3
Ø 12 mm
H 1000 mm

190 mm

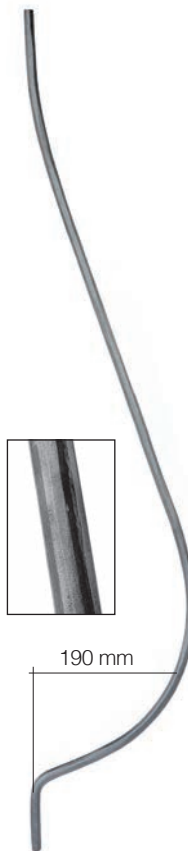

Art. 1783/4
Ø 12 mm
H 1000 mm

190 mm



Art. 1783/8
Ø 12 x 12 mm
H 1000 mm

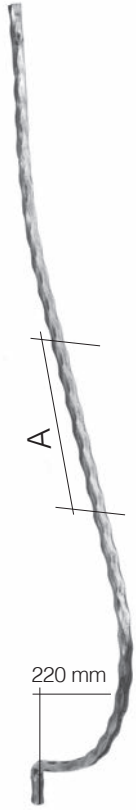

Height Altezza	Section Sezione	Plain Liscio	Hammered Spigolato	A Central twists Attorcigliat. centrale	A Hammered with one stamp Spigolato con schiacciata	A Hammered with basket Spigolato con pigna
		Art.	Art.	Art.	Art.	Art.
H 900 mm	Φ 12 x 12 mm	47/15	47/6	47/3	572/5	47/5
	Φ 14 x 14 mm	47/16	47/12	47/9	572/7	47/11
	Ø 14 mm	47/26	-	-	-	-
H 1000 mm	Φ 12 x 12 mm	47/17	47/14	47/3/1000	-	47/13
	Ø 12 mm	47/28	-	-	-	-
H 1200 mm	Ø 14 mm	47/30	-	-	-	-
H 1500 mm	Ø 14 mm	47/33	-	-	-	-
	Ø 16 mm	47/34	-	-	-	-

Infill elements
for bowed pickets

Elementi di
tamponamento
per pancioni



Hot forged ends
Terminali fucinati
a caldo

Section Sezione	L 150 mm H 350 mm Art.	L 150 mm H 350 mm Art.	L 180 mm H 360 mm Art.	L 180 mm H 360 mm Art.
Φ 12 x 12 mm	1308/12	-	1308/1	1308/3
Φ 14 x 14 mm	-	-	1308/2	1308/4
Ø 14 mm	-	1308/8	1308/11	-
Ø 16 mm	-	1308/9	1308/7	-



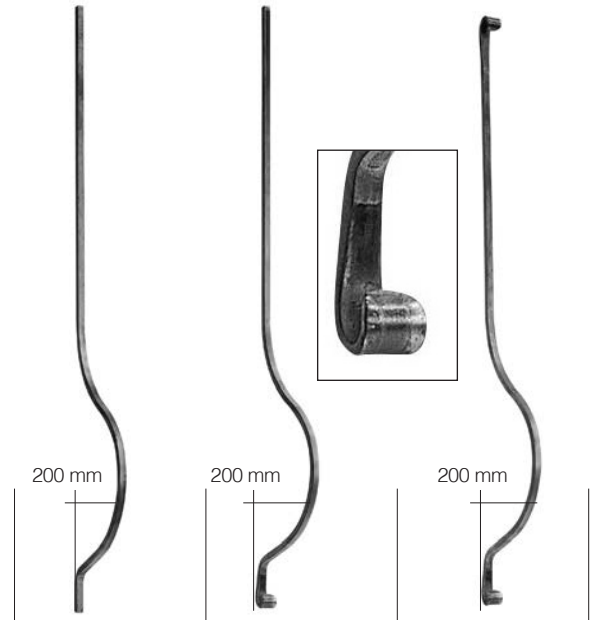





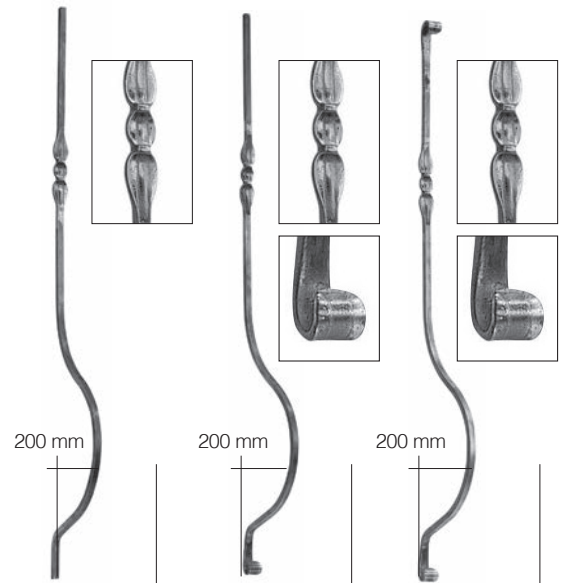

Height Altezza	Section Sezione	Finish Finitura	Art.	Art.	Art.
H 830 mm	Φ 14 x 14 mm	Hammered Spigolato  <input type="checkbox"/>	1267/6	-	-
		Diamond 2 small sides Diamantato 2 lati piccoli  <input type="checkbox"/>	1268/6	1268/24	-
H 1000 mm	Φ 12 x 12 mm	Diamond 2 small sides Diamantato 2 lati piccoli  <input type="checkbox"/>	-	-	1268/40
	Φ 14 x 14 mm	Plain Liscio  <input type="checkbox"/>	-	-	1265/43
H 1200 mm	Φ 14 x 14 mm	Plain Liscio  <input type="checkbox"/>	-	1265/26	-
		Hammered Spigolato  <input type="checkbox"/>	-	1267/26	-
H 1500 mm	Φ 14 x 14 mm	Diamond 2 small sides Diamantato 2 lati piccoli  <input type="checkbox"/>	1268/9	-	-
H 1800 mm	Φ 12 x 12 mm	Plain Liscio  <input type="checkbox"/>	1265/5	-	-
		Diamond 2 small sides Diamantato 2 lati piccoli  <input type="checkbox"/>	1268/5	-	-





Height Altezza	Section Sezione	Finish Finitura	Art.	Art.	Art.
H 1000 mm	Φ 12 x 12 mm	Plain Liscio 	-	1265/29	-
H 1000 mm	Φ 14 x 14 mm	Plain Liscio 	1265/15	-	-
		Hammered Spigolato 	-	1267/33	-
		Diamond 2 small sides Diamantato 2 lati piccoli 	-	1268/33	-
H 1200 mm	Φ 12 x 12 mm	Hammered Spigolato 	-	-	1267/48
	Φ 14 x 14 mm	Diamond 2 small sides Diamantato 2 lati piccoli 	-	1268/34	-
H 1500 mm	Φ 12 x 12 mm	Hammered Spigolato 	-	-	1267/49
H 1800 mm	Φ 12 x 12 mm	Diamond 2 small sides Diamantato 2 lati piccoli 	-	-	1268/50
	Φ 14 x 14 mm	Plain Liscio 	1265/18	-	-



*Stamped like
Stampata
Art. 134/2

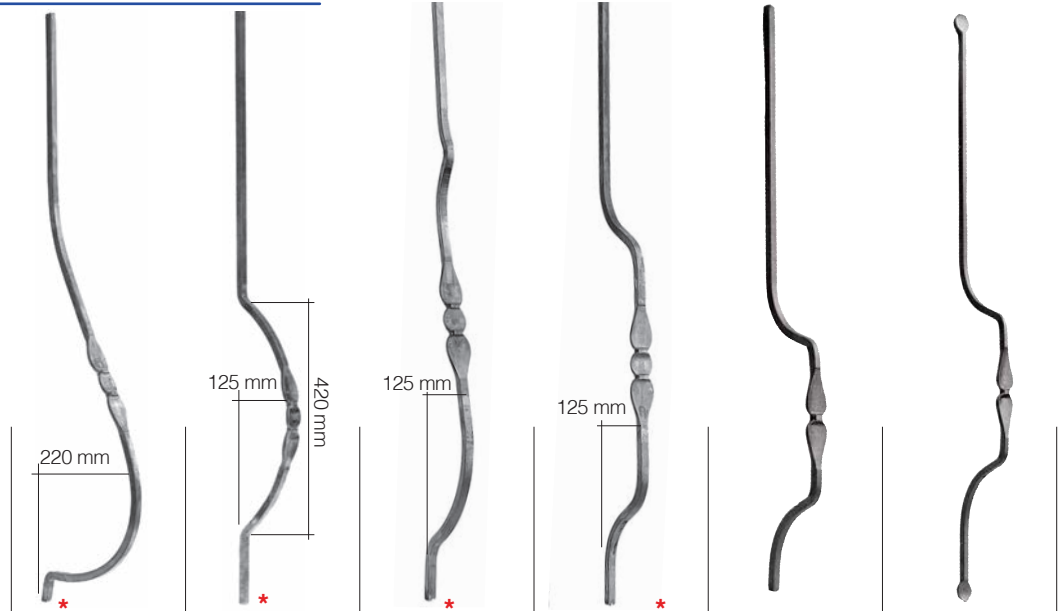

Height Altezza	Section Sezione	Art.	Art.	Art.	Art.	Art.	Art.
H 830 mm	Ø 12 x 12 mm	-	-	-	-	134/29	-
	Ø 14 x 14 mm	-	-	-	-	-	134/35
H 900 mm	Ø 12 x 12 mm	-	-	-	-	-	-
	Ø 14 x 14 mm	586/15	-	-	-	-	-
H 1000 mm	Ø 12 x 12 mm	586/6	586/8	587/12	-	-	-
	Ø 14 x 14 mm	586/7	586/9	-	587/24	-	134/36
H 1200 mm	Ø 12 x 12 mm	-	-	-	-	-	134/43
	Ø 14 x 14 mm	-	-	-	-	-	134/46
H 1500 mm	Ø 12 x 12 mm	-	-	-	-	-	-
H 1800 mm	Ø 12 x 12 mm	-	-	-	-	134/39	-
	Ø 14 x 14 mm	-	-	-	-	-	-
H 1000 mm	Ø 12 mm	586/12	586/10	-	-	-	-
	Ø 14 mm	586/13	586/11	-	-	-	-



Pag.
96

Take a look
at our stamped
pickets

Vai a vedere i
paletti con
schiacciata



	<p>Shaped rounded angle Angolo arrotondato sagomato</p>	<p>Shaped rounded angle Angolo arrotondato sagomato</p>	<p>Shaped rounded angle Angolo arrotondato sagomato</p>
Section Sezione	H 1000 mm	H 1200 mm	H 1000 mm
	Art.	Art.	Art.
∅ 14 x 14 mm	1782/1	1158/8	1782/9

	<p>Shaped rounded angle Angolo arrotondato sagomato</p>	<p>Shaped rounded angle Angolo arrotondato sagomato</p>	<p>Shaped rounded angle Angolo arrotondato sagomato</p>	<p>Sharp welded angle Angolo vivo saldato</p>	<p>Sharp welded angle Angolo vivo saldato</p>	<p>Sharp welded angle Angolo vivo saldato</p>	
	250 mm	360 mm					
Section Sezione	H 820 mm	H 900 mm	H 1000 mm	H 910 mm	H 1000 mm	H 1200 mm	H 1500 mm
	Art.	Art.	Art.	Art.	Art.	Art.	Art.
∅ 14 x 14 mm	70/D/4	70/D/5	70/D/9	1784/1	1784/2	1784/3	1784/4

Height Altezza	Section Sezione	Art.
H 810 mm	Φ 14 x 14 mm	1784/5
H 910 mm	Φ 14 x 14 mm	1784/6
H 950 mm	Φ 14 x 14 mm	-
H 1000 mm	Φ 12 x 12 mm	1784/7/S2
H 1050 mm	Φ 14 x 14 mm	1784/8
H 1500 mm	Φ 14 x 14 mm	1784/9

**Arteferro
products
can be manufactured
as well as customised.**

**I prodotti Arteferro
sono realizzabili
anche su misura.**



170 mm

125 mm

Plain
LiscioHammered
SpigolatoBark effect
Corteccia

Height Altezza	Section Sezione	Art.	Art.	Art.	Art.	Art.
H 1000 mm	Φ 12 x 12 mm	1701/13	1702/13	1705/13	GD273/9	GD274/9
	Φ 14 x 14 mm	1701/14	1702/14	1705/14	GD273/10	GD274/10
	Ø 12 mm	1779/13	1779/11	1779/9	-	-
	Ø 14 mm	1779/14	1779/12	1779/10	-	-

H 1000 mm	Φ 12 x 12 mm	1780/5	1780/3	1780/1	-	-
	Φ 14 x 14 mm	1780/6	1780/4	1780/2	-	-

H 1000 mm	Φ 12 x 12 mm	1780/13	1780/11	1780/9	-	-
	Φ 14 x 14 mm	1780/14	1780/12	-	-	-

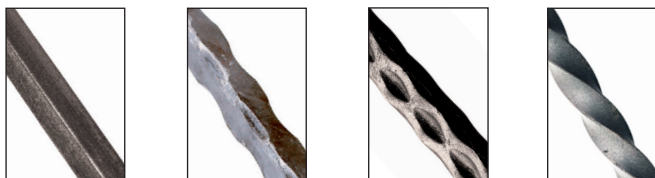
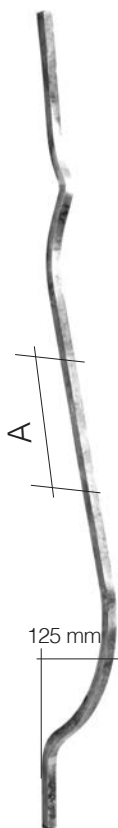

Height Altezza	Section Sezione	Art.	Art.	Art.	Art.
		Plain Liscio	Hammered Spigolato	Diamond Diamantato	A Centre twist Attorcigliat. centrale
H 900 mm	Φ 12 x 12 mm	64/D/4	-	-	64/D/3
	Φ 14 x 14 mm	64/D/9	-	-	-
	Ø 12 mm	64/D/5	-	-	-
	Ø 14 mm	-	-	-	-
H 1000 mm	Φ 12 x 12 mm	1779/7	1780/7	-	64/D/7
	Φ 14 x 14 mm	1779/8	1780/8	1137/12	64/D/10
	Ø 12 mm	1779/15	-	-	-
	Ø 14 mm	1779/16	-	-	-
H 1200 mm	Φ 12 x 12 mm	-	-	1137/13	-
	Φ 14 x 14 mm	-	-	1137/14	-

BEST PRICE

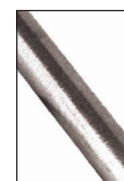
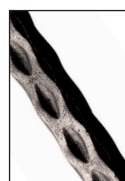
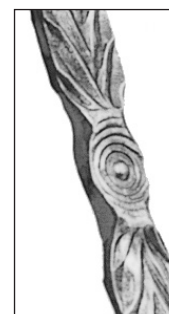

Height Altezza	Section Sezione	Art.	Art.	Art.	Art.	Art.
H 900 mm	Φ 12 x 12 mm	-	64/H/9	-	-	578/17
	Φ 14 x 14 mm	-	64/H/10	-	-	578/19
	Ø 12 mm	572/1	-	-	578/13	-
	Ø 14 mm	572/3	-	-	578/15	-
H 1000 mm	Φ 12 x 12 mm	-	64/H/9/S	1137/7	-	-
	Φ 14 x 14 mm	-	64/H/10/S	1137/8	-	-
H 1200 mm	Φ 12 x 12 mm	-	64/H/19	1137/9	-	578/18
	Φ 14 x 14 mm	-	64/H/20	1137/10	-	578/20
	Ø 12 mm	572/2	-	-	578/14	-
	Ø 14 mm	572/4	-	-	578/16	-

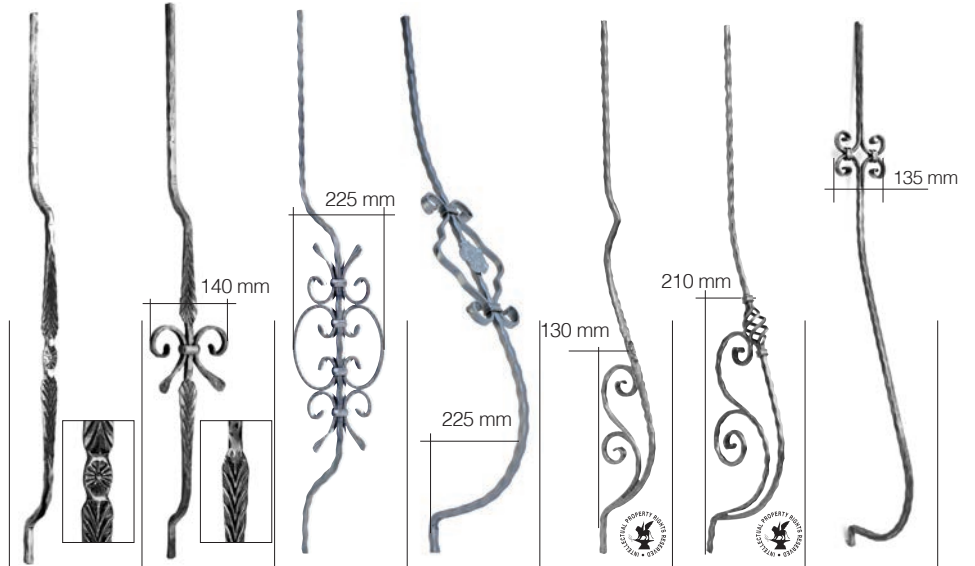

Hammered
Spigolato

Height Altezza	Section Sezione		Art.	Art.	Art.	Art.	Art.	Art.
H 900 mm	Φ 12 x 12 mm	-	-	64/H/7	47/1			
H 1000 mm	Φ 14 x 14 mm	-	-	-	-	1782/6	-	-
H 1200 mm	Φ 12 x 12 mm	64/H/13	64/H/15	64/H/17	-	-	-	-
	Φ 14 x 14 mm	64/H/14	64/H/16	64/H/18	-	-	1782/8	-
H 1300 mm	Φ 14 x 14 mm	-	-	-	-	-	-	98/B/1

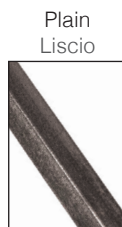

	Art.	Art.	Art.	Art.
Section Sezione	H 900 mm	H 900 mm	H 1000 mm	H 1800 mm
Φ 12 x 12 mm	-	47/4	64/D/1	-
Φ 14 x 14 mm	591/2	47/10	-	1270/10



Art. 47/21
Ø 14 mm
H 1000 mm



Art. 746/1
Cast iron
Ghisa

Art. 1274/3
Φ 12 x 12 mm
H 1200 mm



Art. 1264/6
Φ 16 x 16 mm
fori - holes
Ø 18 mm
120 x 700 mm
base with hole
base con foro
Ø 16 mm



Art. 1264/1
Φ 12 x 12 mm
H 480 mm
Art. 1264/2
Φ 14 x 14 mm
H 480 mm



Bowed on the belly
Bombati sulla pancia

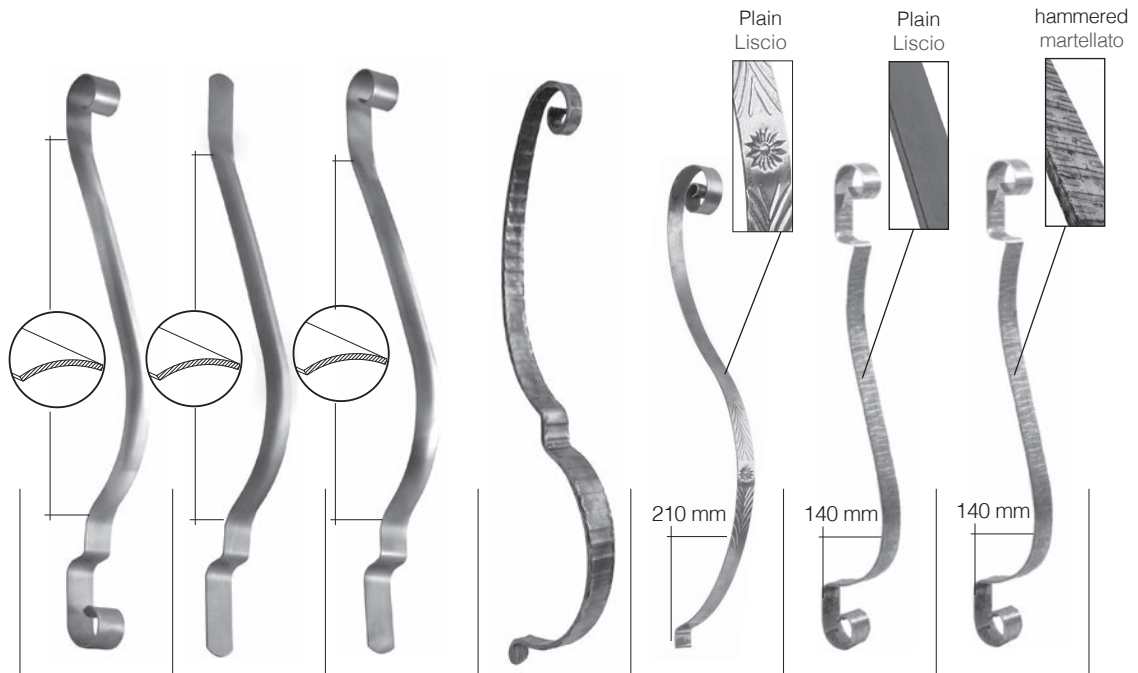

	H 870 mm	H 900 mm	H 900 mm	H 1000 mm	H 800 mm	H 800 mm	H 800 mm
Section Sezione	Art.	Art.	Art.	Art.	Art.	Art.	Art.
∅ 20 x 4 mm	-	-	-	-	-	46/1	-
∅ 30 x 5 mm	-	-	-	-	1785/4	-	-
∅ 40 x 8 mm	-	-	-	-	-	-	-
∅ 50 x 3 mm	46/10	46/11	46/12	-	-	-	-
∅ 50 x 4 mm	-	-	-	-	-	-	46/8
∅ 60 x 8 mm	-	-	-	109/2	-	-	-

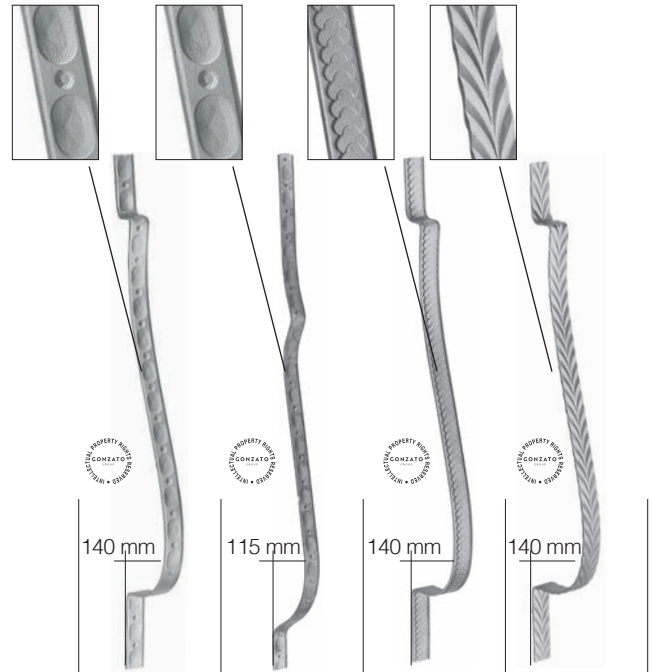

	H 800 mm	H 1000 mm	H 800 mm	H 800 mm
Section Sezione	Art.	Art.	Art.	Art.
∅ 31 x 5 mm	1789/5	1787/1	1789/1	-
∅ 32 x 5 mm	-	-	-	1782/5

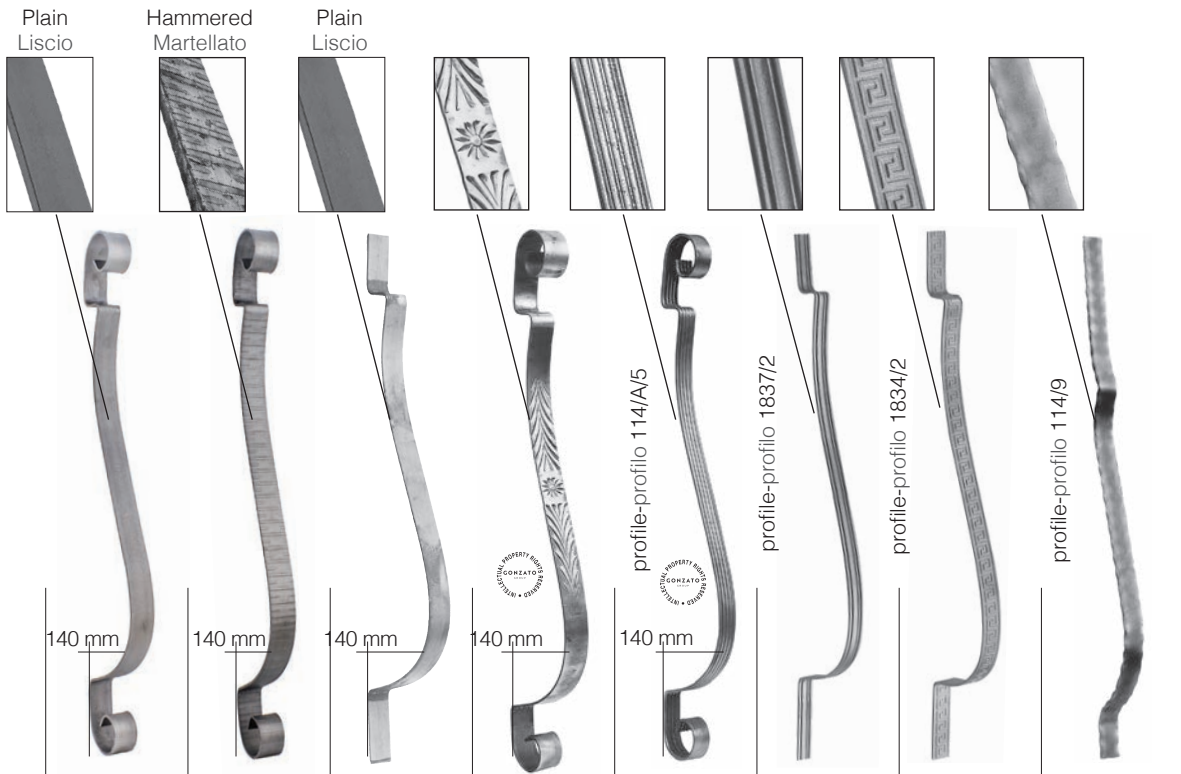

	H 800 mm	H 800 mm	H 800 mm	H 800 mm	H 800 mm	H 800 mm	H 800 mm	H 1000 mm
Section Sezione	Art.	Art.	Art.	Art.	Art.	Art.	Art.	Art.
∅ 25 x 4 mm	46/3	-	-	-	-	-	-	-
∅ 27 x 5 mm	-	-	-	-	-	1789/3	-	-
∅ 30 x 5 mm	-	-	-	-	1276/1	-	-	-
∅ 30 x 8 mm	-	-	-	-	-	-	-	1787/9
∅ 31 x 5 mm	-	-	-	-	-	-	1789/4	-
∅ 40 x 4 mm	46/5	46/6	589/4	589/5	-	-	-	-

Arteferro products can be manufactured as well as customised.

I prodotti Arteferro sono realizzabili anche su misura.

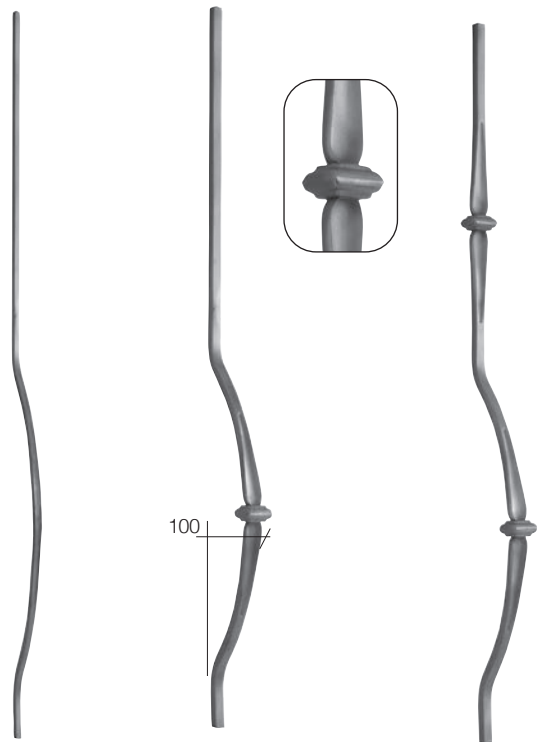

Art. 586/18
∅ 14 x 14 mm
H 1000 mm

Art. 586/19
∅ 14 x 14 mm
H 1000 mm

Art. 586/20
∅ 14 x 14 mm
H 1000 mm



	Art.	Art.	Art.	Art.
Section Sezione	H 1000 mm	H 1000 mm	H 1000 mm	H 1150 mm
∅ 30 x 4 mm	-	-	-	-
∅ 30 x 8 mm	-	-	-	-
∅ 40 x 4 mm	-	-	45/19	1275/1
∅ 40 x 8 mm	44/12	44/14	-	-
∅ 50 x 4 mm	-	-	45/21	-







Pickets for fencing *Paletti per recinzione*

Arteferro pickets are a convenient solution for building a fence. Made with different sections, round or square, they are available in an infinite number of processes and finishes, and can be embellished with other items, like baskets, studs, scrolls, leaves or knots. Just block them with horizontal supporting elements and you're done.

I paletti per recinzione Arteferro rappresentano una comoda soluzione per la composizione di una recinzione. Realizzati con diverse sezioni, tonde o quadrate, sono disponibili in un'infinità di lavorazioni e finiture e possono essere abbelliti con altri elementi quali pigne, borchie, ricci, foglie o nodi. Basterà bloccarli con degli elementi orizzontali a sostegno ed il gioco è fatto.

arteferro

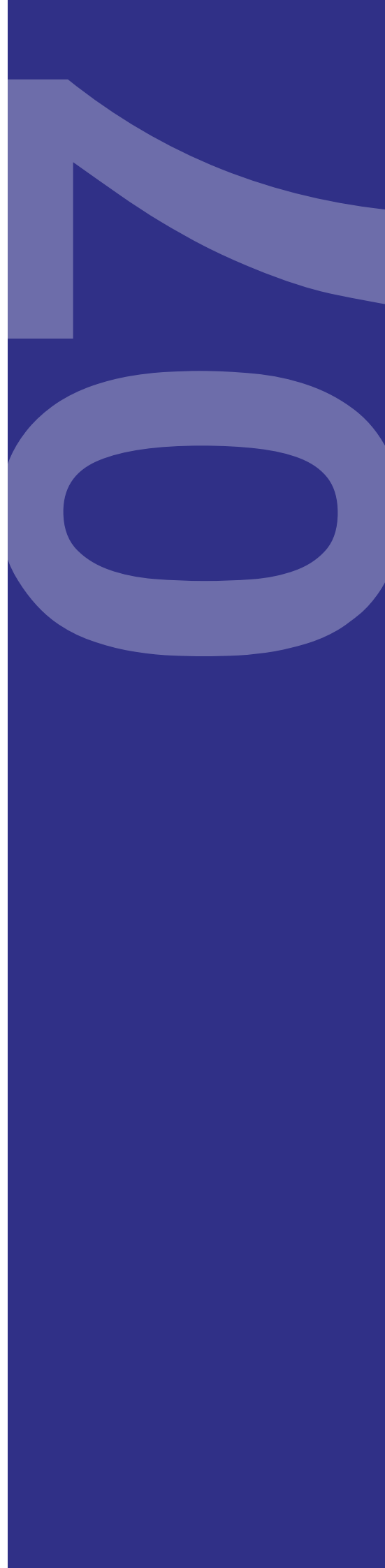

7 Pickets for fencing Paletti per recinzione

- 7.A Stamped picketspag.234
Paletti conati
- 7.B Electrowelded pickets pag.244
Paletti elettrosaldati

CHOOSE YOUR FINISH - SCEGLI LA TUA FINITURA

In a way that matches the manufacturing possibilities, Arteferro products can be customized with the following finishes

Compatibilmente con le possibilità produttive, i prodotti Arteferro si possono personalizzare con le seguenti finiture



Plain finish
Finitura
Liscia



Bark effect finish
Finitura
Corteccia

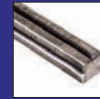

Grooved finish
Finitura
Rigata



Hammered finish
Finitura
Spigolata



Four-leaf clover finish
Finitura
Quadrifoglio

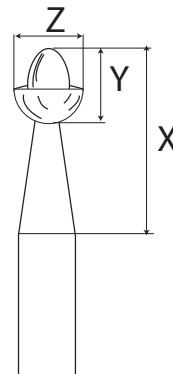
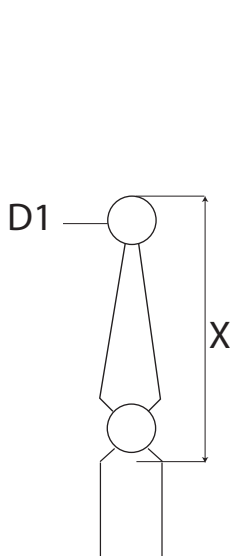







Section - Sezione	Finish - Finitura	H	Art.	Art.
Φ 10 x 10 mm X = 68 mm D1 = Φ 13 mm		150 mm	1758/22	-
		1000 mm	1758/23	1758/26
		1200 mm	1758/24	1758/27
		1500 mm	1758/25	1758/28
Φ 12 x 12 mm X = 80 mm y = Φ 16 mm		150 mm	1758/32	-
		1000 mm	1758/33	1758/36
		1200 mm	-	1758/37
		1500 mm	1758/35	1758/38
Φ 12 mm X = 68 mm D1 = Φ 13 mm		150 mm	1758/1	-
		1000 mm	1758/2	1758/5
		1200 mm	1758/3	1758/6
		1500 mm	1758/4	1758/7
Φ 14 x 14 mm X = 91 mm D1 = Φ 18 mm		150 mm	1758/42	-
		1000 mm	1758/43	1758/46
		1200 mm	1758/44	1758/47
		1500 mm	1758/45	1758/48
Φ 14 mm X = 80 mm D1 = Φ 16 mm		150 mm	1758/8	-
		1000 mm	1758/9	1758/12
		1200 mm	-	1758/13
		1500 mm	-	1758/14

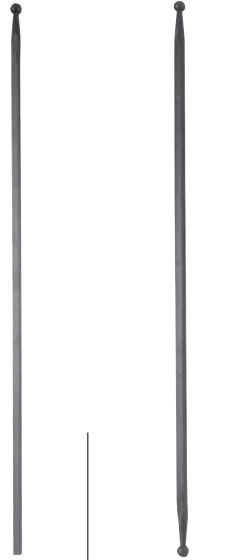
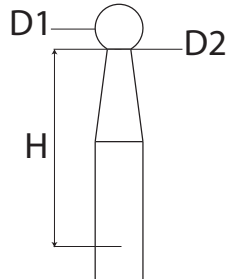

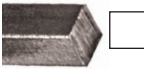
Section - Sezione	Finish - Finitura	H	Art.	Art.
Φ 10 x 10 mm X = 66 mm Y = Φ 21 mm Z = Φ 14 mm		150 mm	1757/29	-
		1000 mm	1757/30	1757/33
		1200 mm	1757/31	1757/34
		1500 mm	1757/32	1757/35
Φ 12 x 12 mm X = 55 mm Y = Φ 23 mm Z = Φ 16 mm		150 mm	1757/39	-
		1000 mm	1757/40	1757/43
		1200 mm	1757/41	1757/44
		1500 mm	1757/42	1757/45
Φ 12 mm X = 66 mm Y = Φ 21 mm Z = Φ 15 mm		150 mm	1757/1	-
		1000 mm	-	1757/5
		1200 mm	1757/3	1757/6
		1500 mm	1757/4	1757/7
Φ 14 x 14 mm X = 55 mm Y = Φ 24 mm Z = Φ 18 mm		150 mm	1757/49	-
		1000 mm	-	1757/53
		1200 mm	1757/51	-
		1500 mm	1757/52	1757/55
Φ 14 mm X = 55 mm Y = Φ 23 mm Z = Φ 16 mm		150 mm	1757/8	-
		1000 mm	-	1757/12
		1200 mm	-	1757/13
		1500 mm	1757/11	1757/14

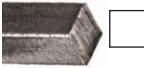
Arteferro products
can be manufactured
as well as customised.

I prodotti Arteferro
sono realizzabili
anche su misura.



Section - Sezione	Finish - Finitura	H	Art.	Art.
Φ 12 x 12 mm H = 31 mm D1 = 16 mm D2 = 7,6 mm	Plain - Liscio 	200 mm	118/C/63	-
		700 mm	118/C/9	118/C/21
		900 mm	118/C/10	118/C/22
		1000 mm	118/C/33	118/C/23
		1200 mm	118/C/53	118/C/23/1200
		1500 mm	118/C/54	-
Φ 12 mm H = 28 mm D1 = 12 mm D2 = 6,1mm	Plain - Liscio 	200 mm	118/C/66	-
		700 mm	118/C/45	118/C/37
		900 mm	118/C/46	118/C/38
		1000 mm	118/C/47	118/C/39
		1200 mm	118/C/58	118/C/39/1200
		1500 mm	118/C/59	-
Φ 14 x 14 mm H = 37 mm D1 = 18 mm D2 = 9,8 mm	Plain - Liscio 	200 mm	118/C/64	-
		700 mm	118/C/11	118/C/3
		900 mm	118/C/12	118/C/4
		1000 mm	118/C/32	118/C/20
		1200 mm	118/C/55	118/C/20/1200
		1500 mm	118/C/56	-
Φ 14 mm H = 28 mm D1 = 16 mm D2 = 6,9 mm	Plain - Liscio 	200 mm	118/C/67	-
		700 mm	118/C/48	118/C/40
		900 mm	118/C/49	118/C/41
		1000 mm	118/C/50	118/C/42
		1200 mm	118/C/60	118/C/42/1200
		1500 mm	118/C/61	-
Φ 16 x 16 mm H = 45 mm D1 = 20 mm D2 = 6,1 mm	Plain - Liscio 	200 mm	118/C/65	-
		700 mm	118/C/72	118/C/106
		900 mm	118/C/34	118/C/24
		1000 mm	118/C/35	118/C/25
		1200 mm	118/C/36	118/C/26
		1500 mm	118/C/57	-
Φ 16 mm H = 25,6 mm D1 = 18 mm D2 = 9,7 mm	Plain - Liscio 	200 mm	118/C/68	-
		700 mm	118/C/96	118/C/40/T16
		900 mm	118/C/97	118/C/43
		1000 mm	118/C/51	118/C/44
		1200 mm	118/C/52	118/C/44/1200
		1500 mm	118/C/62	-

 Plain Liscio		 Plain Liscio			
Diam.	H	Art.	Sec.- Sez.		H
Φ 25 x 25 mm	200 mm	1382/2	Φ 25 mm	200 mm	1382/4
	1000 mm	42/B/5		1000 mm	-
	1200 mm	42/B/6		1200 mm	-
Φ 30 x 30 mm	200 mm	1382/3	Φ 30 mm	200 mm	1382/5
	1000 mm	42/B/7		1000 mm	-
	1200 mm	42/B/8		1200 mm	-
Φ 40 x 40 mm	200 mm	1382/1	Φ 40 mm	200 mm	-
	1000 mm	-		1000 mm	-
	1200 mm	-		1200 mm	-

Newel Post - Caposaldo

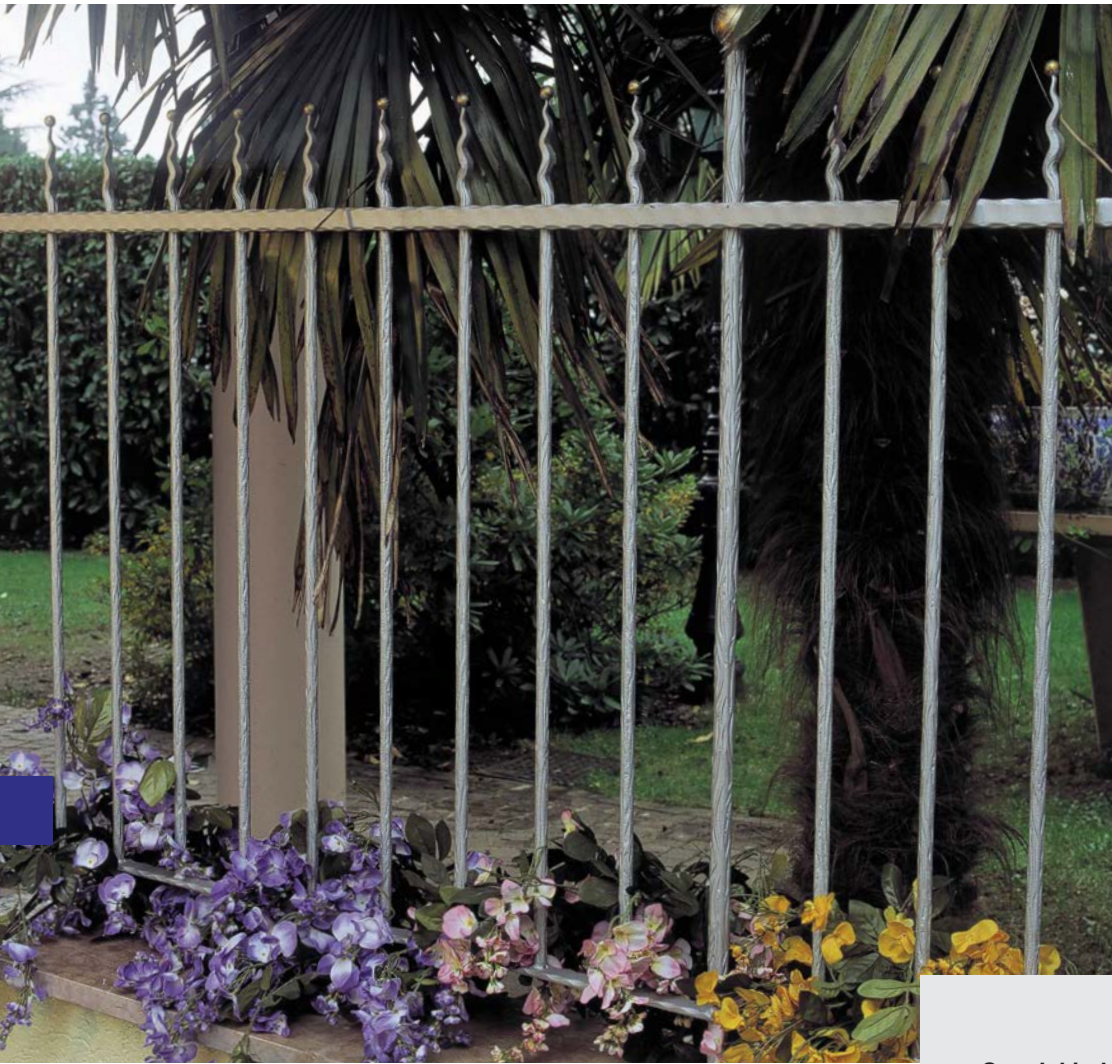

Special height
upon request



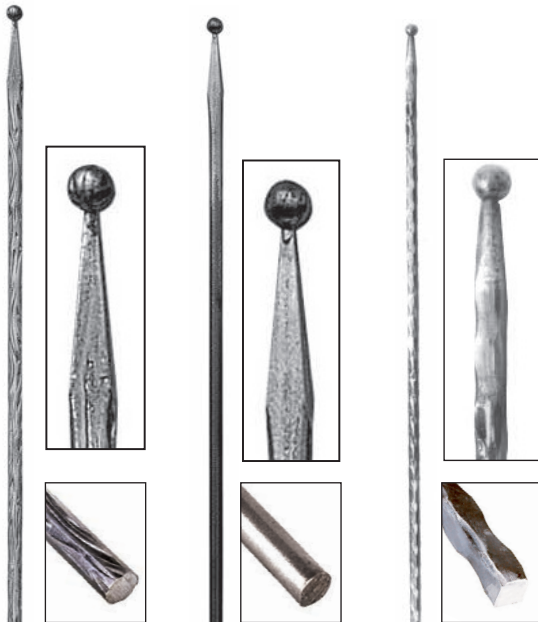



Qualsiasi altezza
su richiesta



Art. 1254/1
Ø 12 x 12 mm
H 1000 mm
Art. 1254/2
Ø 14 x 14 mm
H 1000 mm
Art. 1254/3
Ø 12 x 12 mm
H 1200 mm

Art. 1254/5
Ø 12 x 12 mm
H 1000 mm

Art. 179/1
Ø 14 x 14 mm
H 1000 mm

Section - Sezione	Finish - Finitura	H	Art.	Art.
Ø 12 x 12 mm	Plain Liscio 	1000 mm	-	1258/21
		1200 mm	1259/23	-
	Hammered Spigolato 	1000 mm	-	1258/17
		1200 mm	-	1258/19
	Bark effect Corteccia 	1000 mm	-	-
		1200 mm	-	-
Ø 14 x 14 mm	Plain Liscio 	1000 mm	1259/22	-
		1200 mm	1259/24	1258/24
	Hammered Spigolato 	1200 mm	-	-
Ø 14 mm	Plain Liscio 	1200 mm	1259/8	-
	Bark effect Corteccia 	1200 mm	1259/4	1258/4



Dimensione delle medaglie
Medal dimension:

- Ø 12 x 12 mm
Medaglia/Medal
Ø 32 mm
- Ø 14 x 14 mm
Medaglia/Medal
Ø 35 mm
- Ø 16 x 16 mm
Medaglia/Medal
Ø 42 mm

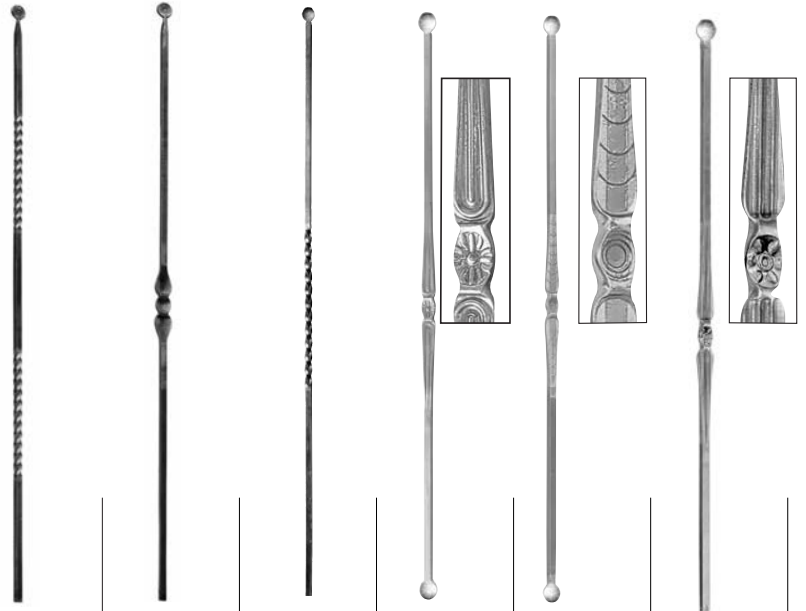

Section - Sezione	Finish - Finitura	H	Art.	Art.	Art.	Art.	Art.	Art.
Ø 12 x 12 mm	Plain Liscio 	800 mm	-	-	-	1756/1	-	-
		1000 mm	1754/19	-	-	1756/2	1756/14	-
		1200 mm	-	-	-	-	1756/15	-
Ø 14 x 14 mm		1000 mm	-	-	1754/47	-	-	-
		1200 mm	-	-	-	-	-	1756/36
Ø 16 x 16 mm		1000 mm	-	1754/16	-	-	-	-
	1500 mm	1754/26	-	-	-	-	-	

Sez../Sect.	Ø 12 mm	Ø 14 mm	Ø 16 mm
H	36 mm	45,5 mm	45,5 mm
D1	16 mm	18 mm	21 mm
D2	7,5 mm	6,4 mm	11,6 mm

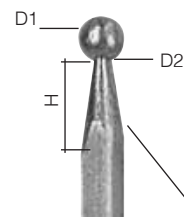
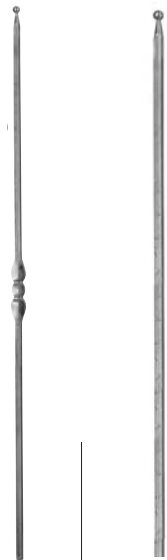

Section - Sezione	Finish - Finitura	H	Art.	Art.
Ø 12 x 12 mm	Plain Liscio 	1500 mm	-	1759/38
Ø 16 x 16 mm		1000 mm	1759/16	-
		1200 mm	1759/17	-
		1500 mm	1759/18	-

Spheres dimension:
Dimensione delle sfere
Ø 12 x 12 mm
Sfera/Sphere Ø 16 mm
Ø 14 x 14 mm
Sfera/Sphere Ø 18 mm
Ø 16 x 16 mm
Sfera/Sphere Ø 21 mm

Plain
Liscio



Plain
Liscio



pyramid spear point - punta piramidale



conic spear point - punta conica



H	Section Sezione	Art.	Art.
300 mm	12 mm	132/C/12	132/C/18
	14 mm	132/C/13	132/C/19
	16 mm	132/C/14	132/C/20
	18 mm	-	-
	20 mm	132/C/15	132/C/21
	22 mm	-	-
	25 mm	132/C/16	132/C/22
900 mm	12 mm	132/B/37	132/C/1 BEST PRICE
	14 mm	132/B/40	132/C/4
	16 mm	132/B/43	132/C/7
	18 mm	-	-
	20 mm	-	-
	22 mm	-	-
	25 mm	-	-
1000 mm	12 mm	-	132/C/32
	14 mm	132/D/1	132/D/11
	16 mm	132/D/3	132/D/13
	18 mm	132/D/5	132/D/15
	20 mm	132/D/8	132/D/18
	22 mm	-	-
	25 mm	-	-
1200 mm	12 mm	132/B/38	132/C/2
	14 mm	132/B/41	132/C/5
	16 mm	132/B/44	132/C/8
	18 mm	-	-
	20 mm	-	-
	22 mm	-	-
	25 mm	-	-
1500 mm	12 mm	132/B/39	132/C/3
	14 mm	132/B/42	132/C/6
	16 mm	132/B/45	132/C/9
	18 mm	132/D/6	132/D/16
	20 mm	132/D/9	132/D/19
	22 mm	-	132/C/28
	25 mm	-	132/C/10
2000 mm	12 mm	-	-
	14 mm	132/D/2	132/D/12
	16 mm	132/D/4	132/D/14
	18 mm	132/D/7	132/D/17
	20 mm	132/D/10	132/D/20
	22 mm	-	132/C/29
	25 mm	-	-
30 mm	-	-	

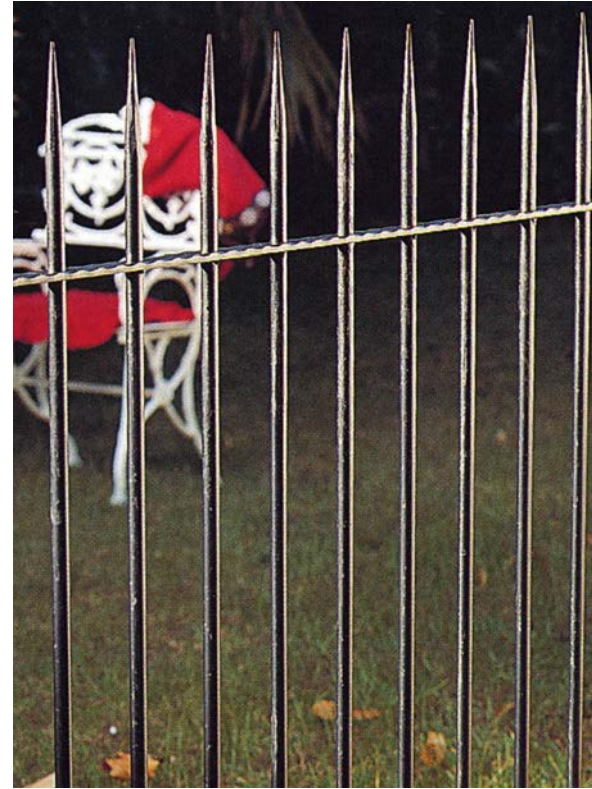

pyramid spear point - punta piramidale



Arteferro products can be manufactured as well as customised.

I prodotti Arteferro sono realizzabili anche su misura.



H	Section Sezione	Art.	Art.
900 mm	12 mm	-	132/B/64
	14 mm	132/B/58	132/B/67
	16 mm	-	132/B/70
1200 mm	12 mm	132/B/56	132/B/65
	14 mm	132/B/59	-
	16 mm	-	132/B/71
1500 mm	12 mm	132/B/57	132/B/66
	14 mm	-	132/B/69
	16 mm	132/B/63	132/B/72
2000 mm	18 mm	132/B/85	132/B/87
	20 mm	132/B/86	132/B/88

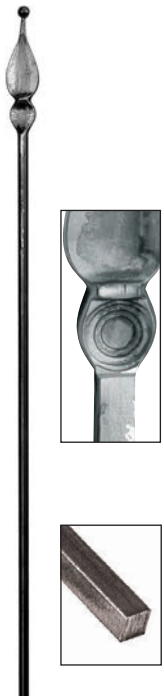

Art. 1765/15
Φ 12 x 12 mm
H 1500 mm

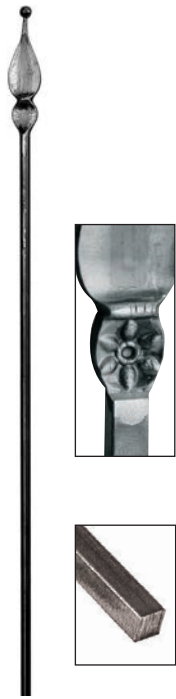

Art. 1765/30
Φ 12 x 12 mm
H 1500 mm
Art. 1765/35
Φ 14 x 14 mm
H 1500 mm



Art. 1765/8
20 x 6 mm
H 1200 mm



Art. 134/28
Φ 14 x 14 mm
H 1200 mm

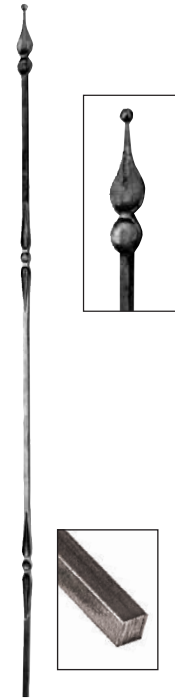

Art. 133/8
Φ 16 x 16 mm
H 2000 mm



Art. 1261/39
Φ 12 x 12 mm
H 1200 mm



Art. 125/1



Art. 125/1



Art. 132/A/1
Φ 12 x 12 mm
H 900 mm
Art. 132/A/5
Φ 14 x 14 mm
H 1200 mm



Art. 132/A/9
Φ 12 x 12 mm
H 1500 mm
Art. 132/A/11
Φ 14 x 14 mm
H 1200 mm



Art. 132/A/23
Φ 14 x 14 mm
H 1200 mm

∅ 20 mm
∅ 30 mm

Top for post
Punta per caposaldo

Sec.-Sez.	Art.	H	H1	L1
∅ 20 mm	-	250 mm	147 mm	60 mm
∅ 30 mm	129/18	250 mm	165 mm	72 mm

Sec.-Sez.	A		B		
	H1	L1	H1	L1	D=∅
∅ 12 mm	115 mm	43 mm	132 mm	43 mm	16 mm
∅ 12 mm	115 mm	40 mm	125 mm	40 mm	14 mm
∅ 14 mm	128 mm	50 mm	143 mm	50 mm	16 mm
∅ 14 mm	125 mm	45 mm	140 mm	45 mm	16 mm

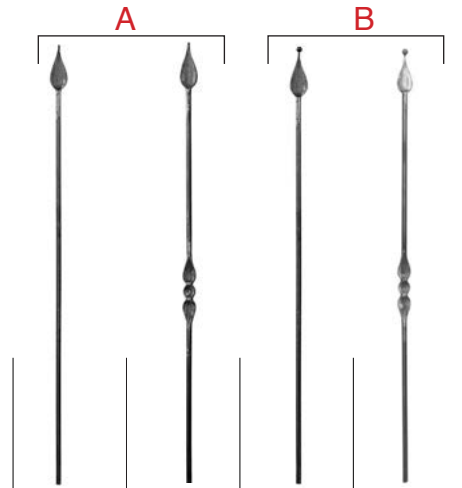
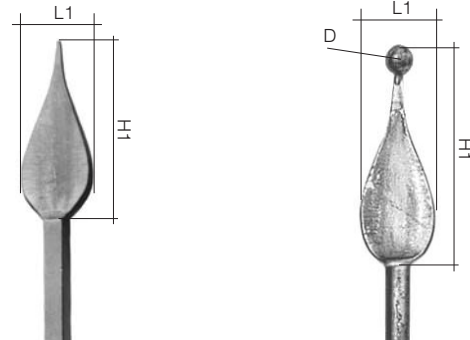

Section - Sezione	Finish - Finitura	H	Art.	Art.	Art.	Art.
∅ 12 x 12 mm	Plain - Liscio 	200 mm	129/10	-	722/5	-
		800 mm	130/31	-	-	-
		900 mm	130/32	-	-	-
		1000 mm	130/33	1263/27	1263/13	1263/19
		1200 mm	130/34	1263/29	1263/15	1263/21
		1500 mm	130/35	1263/31	1263/17	-
∅ 12 mm	Plain - Liscio 	200 mm	1385/7	-	1385/13	-
		1000 mm	1262/37	1262/43	1262/13	1262/19
		1200 mm	1262/39	1262/45	1262/15	1262/21
		1500 mm	1262/41	-	1262/17	1262/23
∅ 14 x 14 mm	Plain - Liscio 	200 mm	129/9	-	722/6	-
		800 mm	130/36	-	-	-
		900 mm	130/37	-	-	-
		1000 mm	130/38	-	1263/14	1263/20
		1200 mm	130/39	1263/30	1263/16	1263/22
		1500 mm	130/40	-	1263/18	1263/24
∅ 14 mm	Plain - Liscio 	200 mm	1385/8	-	1385/14	-
		1000 mm	1262/38	1262/44	1262/14	1262/20
		1200 mm	1262/40	-	1262/16	-
		1500 mm	1262/42	-	1262/18	-



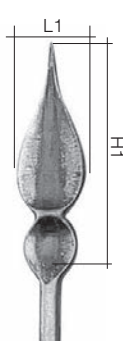

Sec.-Sez.	C		D		
	H1	L1	H1	L1	D=Ø
Φ 12 mm	145 mm	43 mm	132 mm	43 mm	16 mm
Ø 12 mm	145 mm	40 mm	150 mm	40 mm	14 mm
Φ 14 mm	156 mm	50 mm	143 mm	50 mm	16 mm
Ø 14 mm	145 mm	45 mm	163 mm	45 mm	16 mm

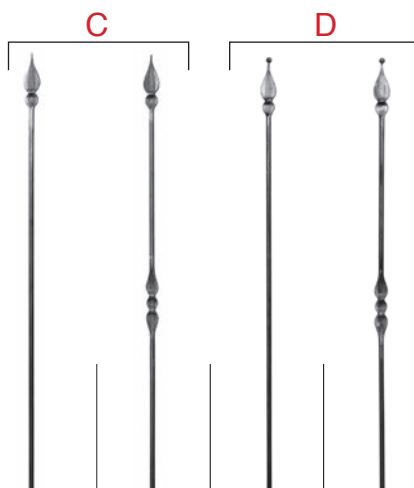

Arteferro products can be manufactured as well as customised.

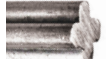
I prodotti Arteferro sono realizzabili anche su misura.



Section - Sezione	Finish - Finitura	H	Art.	Art.	Art.	Art.
Φ 12 x 12 mm	Plain - Liscio 	200 mm	129/8	-	722/3	-
		800 mm	130/1	134/17	-	-
		900 mm	130/2	-	-	-
		1000 mm	130/3	134/18	1263/1	1263/7
		1200 mm	130/4	134/19	1263/3	1263/9
	1500 mm	-	1263/25	1263/5	1263/11	
	Four-leaf clover - Quadrifoglio 	1000 mm	1261/67	1261/55	1260/67	1260/55
1200 mm		1261/69	1261/57	1260/69	1260/57	
1500 mm		1261/71	1261/59	1260/71	1260/59	
Ø 12 mm	Plain - Liscio 	200 mm	1385/4	-	-	-
		1000 mm	1262/25	-	1262/1	1262/7
		1200 mm	1262/27	1262/33	1262/3	1262/9
		1500 mm	1262/29	1262/35	1262/5	1262/11
Φ 14 x 14 mm	Plain - Liscio 	200 mm	129/7	-	722/4	-
		800 mm	130/6	134/20	-	-
		900 mm	130/7	-	-	-
		1000 mm	130/8	134/21	1263/2	1263/8
		1200 mm	-	134/22	1263/4	1263/10
		1500 mm	130/10	1263/26	1263/6	1263/12
Ø 14 mm	Plain - Liscio 	200 mm	1385/5	-	1385/11	-
		1000 mm	1262/26	1262/32	1262/2	-
		1200 mm	1262/28	1262/34	1262/4	-
		1500 mm	1262/30	1262/36	1262/6	-

Sec.-Sez.	A		B			
	H1	L1	H1	L1	D1=Ø	D2=Ø
Φ 12 mm	75 mm	35 mm	85 mm	35 mm	14 mm	6 mm
Ø 12 mm	77 mm	33 mm	80 mm	35 mm	14 mm	6 mm
Φ 14 mm	87 mm	41 mm	85 mm	39 mm	18 mm	7 mm
Ø 14 mm	86 mm	38 mm	85 mm	37 mm	16 mm	7 mm
Φ 16 mm	95 mm	46 mm	105 mm	46 mm	21 mm	7 mm
Ø 16 mm	92 mm	43 mm	100 mm	42 mm	18 mm	7 mm

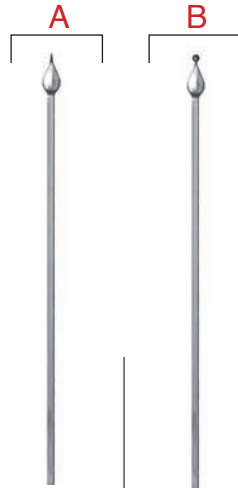

Section - Sezione	Finish - Finitura	H	Art.	Art.
Φ 12 x 12 mm	Plain - Liscio	150 mm	1764/73	1764/43
		1000 mm	1764/76	1764/46
		1200 mm	1764/79	1764/49
		1500 mm	-	1764/52
Ø 12 mm	Plain - Liscio	150 mm	1764/22	1764/1
		1000 mm	1764/25	1764/4
		1200 mm	1764/28	1764/7
		1500 mm	1764/31	1764/10
Φ 14 x 14 mm	Plain - Liscio	150 mm	1764/74	1764/44
		1000 mm	1764/77	1764/47
		1200 mm	1764/80	1764/50
		1500 mm	1764/83	1764/53
Ø 14 mm	Plain - Liscio	150 mm	1764/23	1764/2
		1000 mm	1764/26	1764/5
		1200 mm	1764/29	1764/8
		1500 mm	1764/32	1764/11
Φ 16 x 16 mm	Plain - Liscio	150 mm	1764/75	1764/45
		1000 mm	1764/78	1764/48
		1200 mm	1764/81	1764/51
		1500 mm	1764/84	1764/54
Ø 16 mm	Plain - Liscio	150 mm	1764/24	1764/3
		1000 mm	1764/27	1764/6
		1200 mm	1764/30	1764/9
		1500 mm	1764/33	1764/12

Arteferro products can be manufactured as well as customised.

I prodotti Arteferro sono realizzabili anche su misura.

Sec.-Sez.	H1	H2	L1	L2
Φ 12 mm	165 mm	105 mm	46 mm	98 mm
Φ 14 mm	185 mm	125 mm	52 mm	104 mm

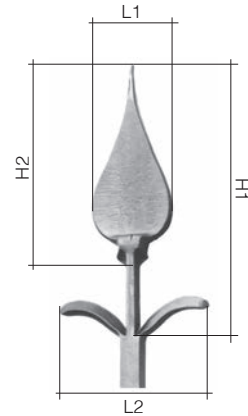

Section - Sezione	Finish - Finitura	H	Art.
Φ 12 x 12 mm	Plain - Liscio	200 mm	129/12
		230 mm	-
		800 mm	130/41
		900 mm	130/42
		1000 mm	130/43
		1200 mm	-
Φ 14 x 14 mm	Plain - Liscio	1500 mm	-
		200 mm	-
		230 mm	129/11
		800 mm	130/46
		900 mm	-
		1000 mm	-
		1200 mm	-
		1500 mm	130/50

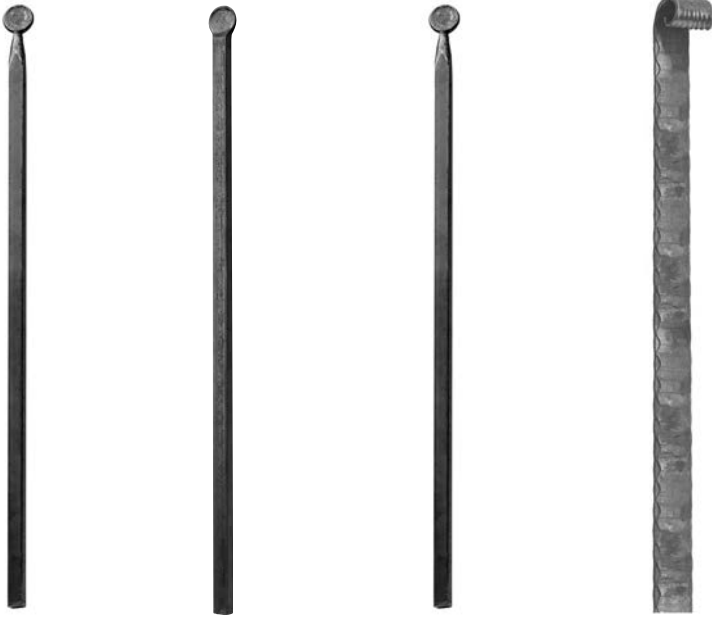

Art. 1766/3
Φ 30 x 30 mm
H 1000 mm

Art. 1766/18
Φ 30 25 25 mm
H 1000 mm

Art. 1766/24
Φ 25 x 25 mm
H 1000 mm

Art. 180/49
40 x 6 mm
H 2500 mm

Art. 1766/19
Φ 30 x 30 mm
H 1000 mm







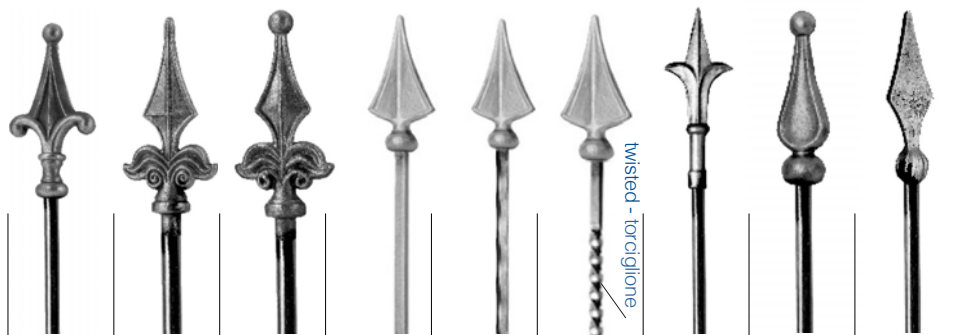

Art. 574/5
Φ 14 x 14 mm
H 900 mm



Art. 132/B/10
Φ 12 x 12 mm
H 900 mm
Art. 132/B/15
Φ 14 x 14 mm
H 1500 mm



Sec. - Sez.	Finish - Finitura	H	Art.	Art.	Art.	Art.	Art.	Art.	Art.	Art.	Art.
Ø 12 x 12 mm	Plain - Liscio 	1000 mm	-	-	-	727/24	-	727/26	-	-	-
		1200 mm	-	-	-	727/27	-	727/29	-	-	-
	Hammered - Spigolato 	1000 mm	-	-	-	-	727/25	-	-	-	-
		1200 mm	-	-	-	-	727/28	-	-	-	-
Ø 12 mm	Plain - Liscio 	1000 mm	1855/11	1855/23	1855/25	-	-	-	124/11	727/34	726/20
		1200 mm	1855/13	1855/24	1855/26	-	-	-	124/13	727/36	726/22
Ø 14 x 14 mm	Plain - Liscio 	1000 mm	-	-	-	727/18	-	727/20	-	-	-
		1200 mm	-	-	-	727/21	-	727/23	-	-	-
	Hammered - Spigolato 	1000 mm	-	-	-	-	727/19	-	-	-	-
		1200 mm	-	-	-	-	727/22	-	-	-	-
Ø 14 mm	Plain - Liscio 	1000 mm	1855/12	-	-	-	-	-	124/12	727/35	726/21
		1200 mm	1855/14	-	-	-	-	-	124/14	727/37	726/23
Ø 16 mm		1000 mm	1855/16	-	-	-	-	-	-	-	-



Spear points are electrowelded to the picket: electrical energy is used to obtain the union between metal parts, the junction between the components is precise and clean.

Le lance sono elettrosaldate ai paletti: sfruttando l'energia elettrica, per ottenere l'unione tra parti metalliche, la giunzione tra i componenti risulta precisa e pulita.





Spear point and Post tops *Lance, Pomoli e Terminali a colonna*

Arteferro spear points and tops reveal the nature of the buildings they protect. A historic symbol of protection for the most prestigious dwellings, you can embellish the pickets, posts and the columns of your fence. Designed to be positioned at the ends of the iron columns, these items reinforce and strengthen any wrought iron artefact.

Le lance ed i pomoli Arteferro rivelano la natura dell'edificio che proteggono. Simbolo storico di protezione delle dimore più prestigiose abbelliscono i paletti, i caposaldi e le colonne della tua recinzione. Ideati per essere posti alle estremità delle colonne in ferro, questi elementi conferiscono slancio e vigore ad ogni manufatto in ferro battuto.

arteferro



Spear points and Post tops - Lance Terminali e Pomoli



A Spear points	A Lance terminali	pag.248
B Tops	B Pomoli	pag.258
C Post tops	C Terminali a colonna	pag.260

HAND FORGED SPEAR POINTS
LANCE FORGIATE A MANO



Art. 120/1
Ø 40 mm
H 220 mm



Art. 120/2
Ø 35 mm
H 200 mm



Art. 120/3
Ø 30 mm
H 170 mm



Art. 1854/7
Ø 28 mm
H 160 mm



Art. 1854/10
Ø 30 mm
H 180 mm



Art. 1854/8
Ø 30 mm
H 160 mm



Art. 1854/9
Ø 32 mm
H 180 mm



Art. 121/5
Ø 25 x 25 mm
H 160 mm



Art. 121/6
Ø 30 x 30 mm
H 186 mm



Art. 121/8
Ø 30 x 30 mm
H 153 mm



Art. 167/15
Ø 30 x 30 mm
H 62 mm



Art. 129/15
Ø 32 mm
H 140 mm



Art. 121/4
Ø 33 mm
H 130 mm



Art. 723/5
Ø 28 mm
H 160 mm



Art. 723/2
Ø 25 mm
H 115 mm

Art. 121/7
Ø 40 x 40 mm
H 186 mm

Art. 121/9
Ø 40 x 40 mm
H 153 mm

Art. 167/16
Ø 40 x 40 mm
H 68 mm



Art. 121/10
Ø 50 x 50 mm
H 290 mm



Art. 121/11
Ø 25 x 25 mm
H 450 mm



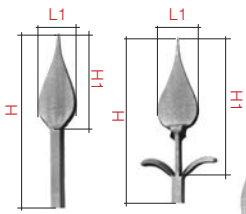

L1 x H1 x H
Hot forged
Fucinate a caldo

Sec- Sez.	Art.	Art.	Art.	Art.	Art.	Art.	Art.	Art.
∅ 12 x 12 mm	129/10 43 x 115 x 165 mm	722/5 43 x 132 x 150 mm	1764/73 35 x 75 x 150 mm	1764/43 35 x 85 x 150 mm	129/8 43 x 145 x 200 mm	722/3 43 x 132 x 200 mm	129/12 46 x 165 x 200 mm	722/1 46 x 180 x 200 mm
∅ 14 x 14 mm	129/9 50 x 128 x 180 mm	722/6 50 x 143 x 170 mm	1764/74 41 x 87 x 150 mm	1764/44 39 x 85 x 150 mm	129/7 50 x 156 x 200 mm	722/4 50 x 143 x 220 mm	129/11 52 x 185 x 230 mm	722/2 52 x 200 x 230 mm
∅ 16 x 16 mm	129/16 54 x 135 x 170 mm	722/7 53 x 145 x 210 mm	1764/75 46 x 95 x 150 mm	1764/45 46 x 105 x 150 mm	129/19 53 x 170 x 220 mm	128/D/9 53 x 170 x 240 mm	129/20 H 230 mm	722/8 H 240 mm
∅ 12 mm	1385/7 40 x 115 x 200 mm	1385/13 40 x 125 x 200 mm	1764/22 33 x 77 x 150 mm	1764/1 35 x 80 x 150 mm	1385/4 40 x 145 x 200 mm	-	-	-
∅ 14 mm	1385/8 45 x 125 x 200 mm	1385/14 45 x 140 x 200 mm	1764/23 38 x 86 x 150 mm	1764/2 37 x 85 x 150 mm	1385/5 45 x 145 x 200 mm	1385/11 45 x 163 x 200 mm	-	-
∅ 16 mm	1385/9 52 x 135 x 200 mm	1385/15 51 x 140 x 200 mm	1764/24 43 x 92 x 150 mm	1764/3 42 x 100 x 150 mm	1385/6 50 x 160 x 200 mm	1385/12 50 x 175 x 200 mm	-	-

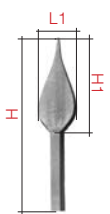

Hot forged
Fucinate a caldo



hammered
spigolato

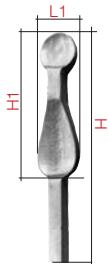

Sec- Sez.	Art.	Art.	Art.	Art.
∅ 12 x 12 mm	1385/1 35 x 75 x 150 mm	-	129/4 34 x 140 x 180 mm	129/2 30 x 132 x 190 mm
∅ 14 x 14 mm	1385/2 40 x 90 x 150 mm	-	129/3 38 x 148 x 190 mm	129/1 40 x 147 x 200 mm
∅ 16 x 16 mm	1385/3 42 x 100 x 140 mm	-	-	-
∅ 30 x 30 mm	1385/17 80 x 200 x 300 mm	129/18 72 x 165 x 250 mm	-	-

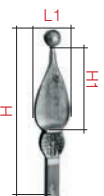

Cold stamped
Stampate a freddo



Sec- Sez.	Art.	Art.
∅ 12 x 12 mm	-	1765/41 31 x 130 x 200 mm
∅ 14 x 14 mm	1765/16 37 x 130 x 200 mm	1765/46 37 x 130 x 200 mm
∅ 16 x 16 mm	1765/21 40 x 130 x 200 mm	1765/51 40 x 130 x 200 mm



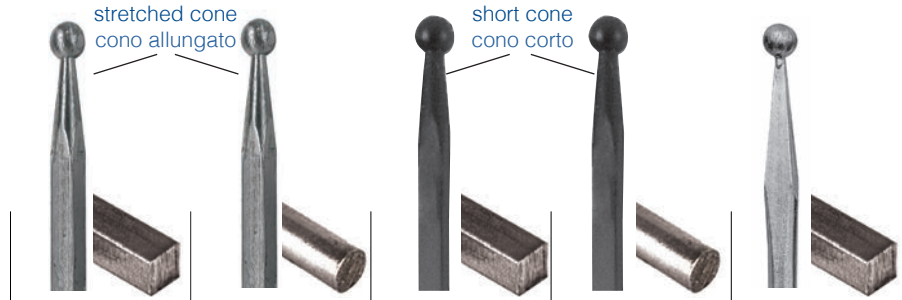

Section Sezione	Height Altezza	Art.	Art.	Art.	Art.	Art.
12 x 12 mm	200 mm	1759/45	-	118/C/63	118/C/66	1382/21
	250 mm	-	-	-	-	-
14 x 14 mm	200 mm	1759/46	-	118/C/64	118/C/67	-
	250 mm	-	-	-	-	-
16 x 16 mm	200 mm	-	-	118/C/65	118/C/68	-
	250 mm	-	-	-	-	-
25 x 25 mm	200 mm	1382/2	-	-	-	-
	250 mm	-	-	-	-	-
30 x 30 mm	200 mm	1382/3	-	-	-	-
	250 mm	-	1382/4	-	-	-
40 x 40 mm	200 mm	1382/1	-	-	-	-
	250 mm	-	1382/5	-	-	-

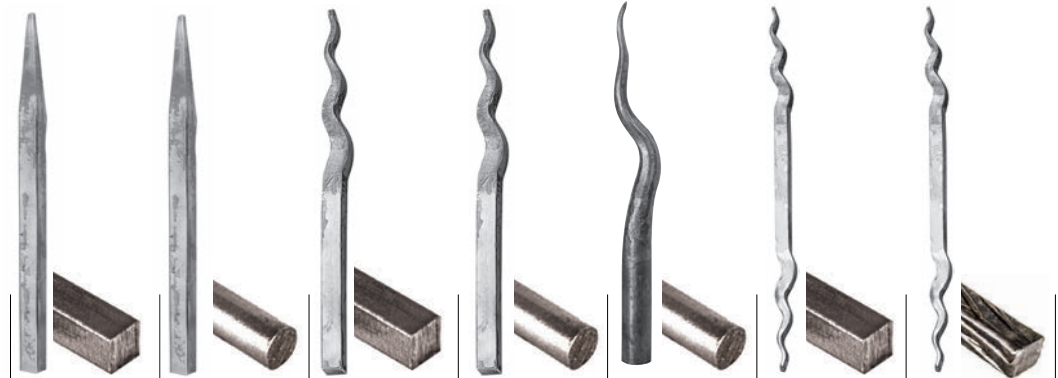

Section Sezione	Height Altezza	Art.	Art.	Art.	Art.	Art.	Art.	Art.
14 x 14 mm	300 mm	132/C/12	132/C/18	1381/1	1381/7	-	-	-
	250 mm	-	-	-	-	-	-	-
16 x 16 mm	300 mm	132/C/13	132/C/19	1381/2	1381/8	-	1381/11	1381/5
	250 mm	-	-	-	-	-	-	-
20 x 20 mm	300 mm	132/C/13	132/C/20	1381/3	1381/9	-	1381/12	-
	250 mm	-	-	-	-	1380/1	-	-
	300 mm	132/C/15	132/C/21	-	-	-	-	-

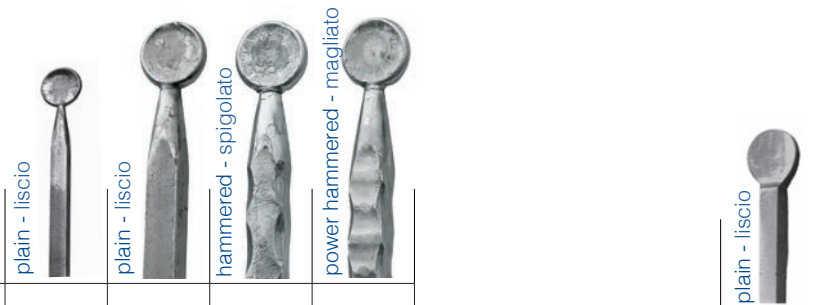
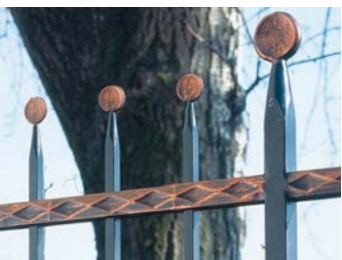

Section Sezione	Height Altezza	Art.	Art.	Art.	Art.
12 x 12 mm	200 mm	1754/45	-	-	-
14 x 14 mm	200 mm	1754/46	-	-	-
16 x 16 mm	200 mm	1754/47	-	-	-
25 x 25 mm	300 mm	-	-	1766/35	1766/37
30 x 30 mm	300 mm	-	1766/34	1766/36	-

Section Sezione	Height Altezza	Art.
12 x 12 mm	100 mm	129/6
14 x 14 mm	110 mm	129/5
25 x 25 mm	300 mm	-
30 x 30 mm	300 mm	-



10.000.000

are the spear points that are shipped from our factories every year, and go on to adorn the most beautiful villas in the world

sono le lance che escono ogni anno dai nostri stabilimenti e vanno ad ornare le più belle ville del mondo





Art. 126/B/4
Ø 20 mm
70 x 130 mm



Art. 126/C/6
Ø 23 mm
70 x 160 mm



Art. 122/6
Ø 30 mm
H 195 mm
tubular boss
borchia in tubo
Ø 12 mm



Art. 123/7
Ø 40 mm
H 200 mm



Art. 726/4
Ø 24 mm
H 125 mm
Art. 126/9
Ø 20 mm
H 90 mm



Art. 726/3
Ø 30 mm
H 180 mm



Art. 126/6
Ø 34 mm
H 190 mm
Art. 126/19
Ø 25 mm
H 140 mm
Art. 126/20
Ø 30 mm
H 160 mm



Art. 123/6
Ø 35 mm
H 180 mm



Art. 1855/10
Ø 30 mm
H 170 mm



Art. 122/A/1
Ø 35 mm
H 200 mm



Art. 1855/7
Ø 31 mm
60 x 180 mm
Art. 1855/6
Ø 26 mm
48 x 150 mm



Art. 1855/9
Ø 35 mm
H 200 mm



Art. 1855/8
Ø 40 mm
H 220 mm



Art. 125/1
Ø 35 mm
H 125 mm



Art. 125/2
Ø 14 x 14 mm
H 135 mm



Art. 1386/12
Ø 32 mm
60 x 125 mm
Art. 1386/13
Ø 25 mm
55 x 110 mm



Art. 727/1
Ø 32 mm
70 x 140 mm
Art. 727/2
Ø 30 mm
65 x 125 mm
Art. 727/3
Ø 25 mm
55 x 110 mm



Art. 1386/11
Ø 16 mm
650 x 150 mm



Art. 124/6
Ø 15 mm
H 155 mm

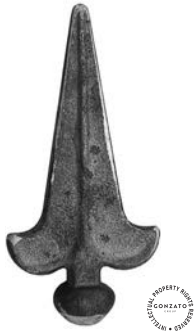

Art. 725/1
Ø 30 mm
H 165 mm



Art. 122/3
10 x 4 mm
H 90 mm



Art. 123/4
15 x 10 mm
H 140 mm



Art. 125/4
Ø 20 mm
H 130 mm



Art. 126/C/1
Ø 24 mm
70 x 155 mm



Art. 727/6
Ø 24 mm
60 x 160 mm



Art. 126/17
Ø 25 x 25 mm
H 290 mm

Art. 727/5
Ø 27 mm
70 x 185 mm
Art. 727/4
Ø 30 mm
80 x 210 mm



Art. 126/C/9
Ø 40 mm
80 x 150 mm



Art. 126/C/2
Ø 12 x 12 mm
60 x 140 mm



Art. 127/1
Ø 10 x 10 mm
H 70 mm

Art. 127/2
Ø 12 x 12 mm
H 70 mm

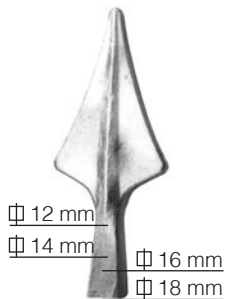

Art. 126/D/1
Ø 18 x 18 mm
60 x 155 mm



Art. 726/1
Ø 12 x 12 mm
H 185 mm



Art. 726/2
Ø 12 x 12 mm
H 165 mm



Art. 1386/6
Ø 12 x 12 mm
H 120 mm
Art. 1386/5
Ø 14 x 14 mm
H 140 mm





Art. 726/16
Ø 12 mm
H 100 mm
Art. 726/17
Ø 15 mm
H 125 mm



Art. 726/10
H 100 mm
base Ø 12 mm
Art. 726/11
H 125 mm
base Ø 15 mm



Art. 726/13
Ø 23 mm
H 140 mm
Art. 726/15
Ø 32 mm
H 200 mm



Art. 726/5
Ø 13 mm
48 x 140 mm



Art. 126/E/1
Ø 15 mm
55 x 150 mm



Art. 126/A/1
Ø 15 mm
68 x 150 mm



Art. 726/18
Ø 17 x 17 mm
50 x 170 mm



Art. 126/E/2
Ø 16 mm
90 x 160 mm



Art. 726/19
Ø 14 x 14 mm
80 x 140 mm



Art. 726/12
Ø 18 mm
H 110 mm



Art. 726/9
Ø 35 mm
H 190 mm



Art. 126/C/5
Ø 25 mm
44 x 125 mm
Art. 126/C/4
Ø 33 mm
57 x 140 mm
Art. 126/C/3
Ø 40 mm
70 x 190 mm



Art. 126/B/5
Ø 50 mm
85 x 165 mm



Art. 725/5
base Ø 27 mm
43 x 220 mm



Art. 725/2
Ø 32 mm
H 225 mm



Art. 725/4
base Ø 50 mm
H 235 mm



Art. 725/3
Ø 18 x 18 mm
H 285 mm



Art. 1386/9
Ø 26 mm
70 x 140 mm

Art. 1386/10
Ø 21,5 mm
60 x 115 mm



Art. 126/8
Ø 20 mm
H 112 mm

Art. 126/21
Ø 25 mm
H 135 mm



Art. 1855/5
Ø 12 mm
60 x 135 mm



Art. 1855/4
Ø 12 mm
60 x 135 mm



Art. 726/6
Ø 22 mm
H 120 mm

Art. 726/7
Ø 26 mm
H 135 mm



Art. 1855/1
Ø 24 mm
65 x 128 mm

Art. 1855/2
Ø 25 mm
70 x 140 mm

Art. 1855/3
Ø 32 mm
86 x 170 mm



Art. 1386/7
Ø 16 mm
70 x 155 mm

Art. 1386/8
Ø 12 mm
60 x 130 mm



Art. 124/1
Ø 12 mm
H 125 mm

Art. 124/2
Ø 15 mm
H 160 mm

Art. 124/9
Ø 20 mm
H 190 mm



Art. 124/7
Ø 14 mm
H 127 mm



Art. 124/3
Ø 12 mm
H 125 mm

Art. 124/4
Ø 15 mm
H 160 mm

Art. 124/5
Ø 16,5 mm
H 190 mm



Art. 126/B/1
Ø 19 mm
82 x 195 mm

Art. 126/B/2
Ø 16 mm
68 x 160 mm

Art. 126/B/3
Ø 13 mm
54 x 130 mm



Art. 124/8
Ø 15 mm
72 x 215 mm



Art. 126/13
Ø 16 mm
64 x 170 mm

Art. 126/14
Ø 16 mm
55 x 140 mm



Art. 126/B/6
Ø 20 mm
45 x 80 mm

Art. 126/B/7
Ø 25 mm
64 x 125 mm

Art. 126/B/8
Ø 38 mm
80 x 140 mm



Art. 1387/2
Ø 27 x 27 mm
H 100 mm



Art. 1387/3
Ø 20 x 20 mm
H 133 mm



Art. 727/7
Ø 40 x 40 mm
120 x 200 mm

Art. 727/8
Ø 32 x 32 mm
90 x 160 mm

Art. 727/9
Ø 25 x 25 mm
70 x 120 mm





Art. 574/13
Ø 14 x 14 mm
H 250 mm



Art. 44/6
Ø 25 x 25 mm
H 200 mm

Art. 44/7
Ø 30 x 30 mm
H 200 mm



Art. 724/1
Ø 35 mm
H 295 mm



Art. 126/18
Ø 40 x 40 mm
H 150 mm



Art. 123/5
Ø 25 x 25 mm
H 160 mm



Art. 123/3
Ø 32 mm
H 130 mm



Art. 1386/2
Ø 32 x 32 mm
H 135 mm



Art. 1386/1
Ø 40 x 40 mm
H 150 mm

Art. 1386/2
Ø 32 x 32 mm
H 135 mm

Art. 1386/3
Ø 25 x 25 mm
H 125 mm

Art. 1386/4
Ø 20 x 20 mm
H 100 mm



Art. 126/2
Ø 20 x 20 mm
H 130 mm
Art. 126/15
Ø 30 x 30 mm
H 160 mm
Art. 126/16
Ø 40 x 40 mm
H 190 mm



Art. 126/1
Ø 10 x 10 mm
H 140 mm



Art. 727/10
Ø 33 mm
40 x 150 mm
Art. 727/11
Ø 30 mm
35 x 120 mm



Art. 126/C/7
Ø 18 mm
H 125 mm
Art. 126/C/8
Ø 12 x 12 mm
H 100 mm

MALLEABLE, WELDABLE CAST IRON SPEARS GALVANIZING IS NOT RECOMMENDED
LANCE IN GHISA MALLEABILE SALDABILE - NON ZINCABILE



Art. 733/1
 ⌀ 20 x 20 mm
 35 x 155 mm
 Hole-Foro ⌀ 20 mm
Art. 733/2
 ⌀ 25 x 25 mm
 45 x 205 mm
 Hole-Foro ⌀ 25 mm
Art. 733/3
 ⌀ 12 x 12 mm
 23 x 110 mm
 Hole-Foro ⌀ 12 mm
Art. 733/4
 ⌀ 16 x 16 mm
 25 x 110 mm
 Hole-Foro ⌀ 16 mm



Art. 731/5
 ⌀ 12 x 12 mm
 23 x 110 mm
 Hole-Foro ⌀ 12 mm
Art. 731/6
 ⌀ 16 x 16 mm
 25 x 110 mm
 Hole-Foro ⌀ 16 mm
Art. 731/7
 ⌀ 18 x 18 mm
 30 x 110 mm
 Hole-Foro ⌀ 18 mm



Art. 732/1
 ⌀ 12 x 12 mm
 23 x 135 mm
 Hole-Foro ⌀ 12 mm
Art. 732/2
 ⌀ 16 x 16 mm
 25 x 135 mm
 Hole-Foro ⌀ 16 mm
Art. 732/3
 ⌀ 18 x 18 mm
 25 x 135 mm
 Hole-Foro ⌀ 18 mm



Art. 735/1
 ⌀ 14 x 14 mm
 27 x 140 mm
 Hole-Foro ⌀ 14 mm



Art. 735/2
 ⌀ 14 x 14 mm
 20 x 115 mm
 Hole-Foro ⌀ 14 mm



Art. 734/3
 ⌀ 14 x 14 mm
 24 x 103 mm
 Hole-Foro ⌀ 14 mm



Art. 735/3
 ⌀ 14 x 14 mm
 25 x 155 mm
 Hole-Foro ⌀ 14 mm



Art. 736/1
 ⌀ 14 x 14 mm
 28 x 140 mm
 Hole-Foro ⌀ 14 mm



Art. 736/2
 ⌀ 14 x 14 mm
 25 x 140 mm
 Hole-Foro ⌀ 14 mm



Art. 736/3
 Ø 14 mm
 30 x 140 mm
 Hole-Foro Ø 14 mm



Art. 731/1
 Ø 16 mm
 64 x 170 mm



Art. 731/3
 Ø 15 mm
 55 x 150 mm



Art. 734/1
 Ø 14 mm
 25 x 135 mm
 Hole-Foro Ø 14 mm
Art. 734/2
 Ø 12 mm
 25 x 100 mm
 Hole-Foro Ø 12 mm

CAST IRON - GHISA



Art. 749/12
base Ø 30 mm
H 60 mm



Art. 749/7
base Ø 28 mm
H 55 mm



Art. 749/17
base Φ 25 x 25 mm
H 60 mm



Art. 749/4
base Ø 27 mm
H 65 mm

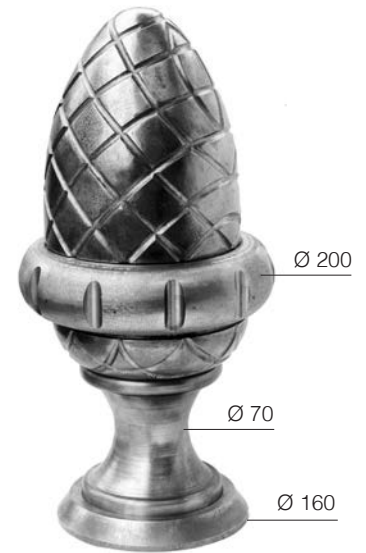

Art. 128/C/2
base Ø 160 mm
H 405 mm

Art. 749/13
base Ø 43 mm
H 85 mm

Art. 749/8
base Ø 42 mm
H 85 mm

Art. 749/18
base Φ 40 x 40 mm
H 85 mm

Art. 749/5
base Ø 40 mm
H 85 mm

Art. 749/14
Base Ø 49 mm
H 125 mm

Art. 749/9
base Ø 55 mm
H 120 mm

Art. 749/19
base Φ 60 x 60 mm
H 125 mm

Art. 749/6
base Ø 55 mm
H 120 mm

Art. 749/15
base Ø 60 mm
H 150 mm

Art. 749/10
base Ø 70 mm
H 150 mm

Art. 749/20
base Φ 80 x 80 mm
H 150 mm

Art. 749/16
base Ø 90 mm
H 200 mm

Art. 749/11
base Ø 90 mm
H 190 mm



Art. 128/33
base Ø 28 mm
H 80 mm



Art. 749/3
Ø 50 mm
H 190 mm



Art. 128/29
Ø 50 mm
H 105 mm



Art. 749/1
base Ø 35 mm
H 155 mm



Art. 749/2
base Ø 22 mm
H 95 mm

Art. 128/30
base Ø 50 mm
H 100 mm

Art. 128/34
base Ø 100 mm
H 200 mm



Art.	A	B	H
1404/1	110 mm	90 mm	140 mm
1404/2	90 mm	70 mm	125 mm
1404/3	70 mm	55 mm	100 mm
1404/4	55 mm	45 mm	85 mm

Art.	A	B	H
1404/6	85 mm	80 x 80 mm	120 mm
1404/7	70 mm	60 x 60 mm	105 mm
1404/8	50 mm	40 x 40 mm	75 mm
1404/9	30 mm	25 x 25 mm	45 mm

Art.	A	H
128/31	100 mm	180 mm
128/35	50 mm	90 mm

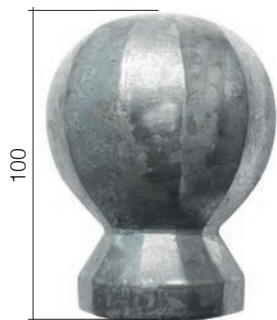

Art. 749/22
Ø 70 mm
base Ø 51 mm



Art. 116/A/20
sfera Ø 55 mm
base Ø 38 mm

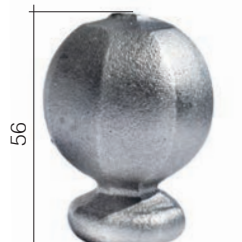

Art. 116/A/21
sfera Ø 40 mm
base Ø 26 mm

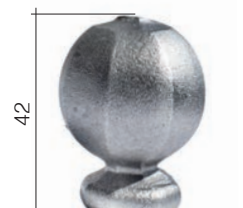

Art. 116/A/22
sfera Ø 30 mm
base Ø 22 mm



Art. 113/9
Ø 75 mm



Art. 113/10
Ø 70 mm

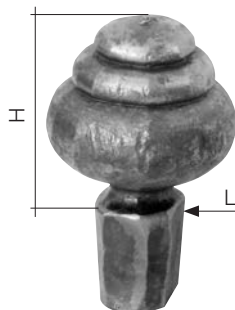

Art. 116/A/19
Ø 55 mm
L 30 x H 65 mm

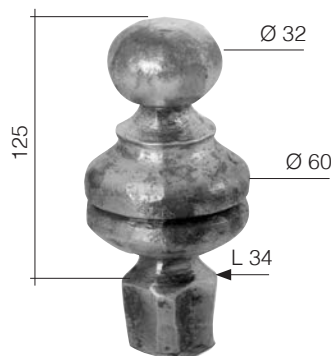

Art. 116/A/18
Ø 60 mm



Art. 595/7/S
Ø 20 mm
H 150 mm

WELDED TOPS - POMOLI SALDATI



Art. 1400/1
H 100 mm
base Ø 25 mm
Ø 160 mm



Art. 1399/1
H 140 mm
base Ø 25 mm
Ø 115 mm





Hollow sphere
Sfera vuota
Art. 1165/6

for tube - per tubo
Φ 30 x 30 mm
Ø 40 mm
Art. 1165/5
for tube - per tubo
Φ 40 x 40 mm
Ø 50 mm



Entirely welded sheet metal
Lamiera saldata interamente

Art. 1858/1

for tube - per tubo
Φ 50 x 50 mm
H 70 mm
Art. 1858/2
for tube - per tubo
Φ 60 x 60 mm
H 84 mm



Steel sheet
Lamiera puntata
Art. 167/11

for tube - per tubo
Φ 80 x 80 mm
H 115 mm
Art. 167/14
for tube - per tubo
Φ 150 x 150 mm
H 192 mm



Hand forged
Forgiato a mano

Art. 167/15
Φ 30 x 30 mm
H 62 mm
Art. 167/16
Φ 40 x 40 mm
H 68 mm

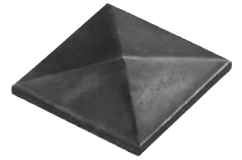

Art. 167/3
for tube - per tubo
Φ 30 x 30 mm
Art. 167/4
for tube - per tubo
Φ 40 x 40 mm
Art. 167/6
for tube - per tubo
Φ 60 x 60 mm
Art. 167/8
for tube - per tubo
Φ 100 x 100 mm



Hand forged
Forgiato a mano

Art. 178/35
Φ 40 mm
plain - liscio
120 x 300 mm
Art. 178/36
Φ 30 mm
120 x 300 mm
plain - liscio



Hand forged
Forgiato a mano

Art. 593/3/S1
Φ 40 mm
spigolato - spigolato
130 x 350 mm
Art. 593/3/S4
Φ 40 mm
plain - liscio
130 x 350 mm



Art. 593/10
∇ 50 x 6 mm
plain - liscio
70 x 300 mm
Art. 593/11
∇ 60 x 6 mm
plain - liscio
70 x 300 mm



Art. 6112/4/S
Ø 25 mm
L 150 x 250 mm



Art. 596/4/S3
Ø 25 mm
L150 x H 300 mm



Art. 178/20
Φ 30 x 30 mm
H 300 mm
Art. 178/29
Φ 40 x 40 mm
H 300 mm



plain

liscio



Art. 178/22
Φ 30 x 30 mm
H 300 mm
Art. 178/30
Φ 40 x 40 mm
H 300 mm



hammered

spigolato



Art. 593/1
∇ 30 x 20 mm
H 300 mm



Forgiato a mano
Hand forged

Art. 178/37
Φ 35 mm
H 300 mm

Sheet metal cap spot welded
Lamiera d'acciaio puntata



Art. 1858/3
70 x 70 mm
H 98 mm

Art. 1858/5
100 x 100 mm
H 136 mm

Art. 1858/7
150 x 150 mm
H 192 mm

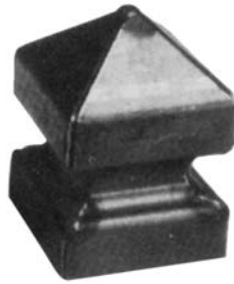

Art. 167/12
H 136 mm

Art. 167/13
H 164 mm

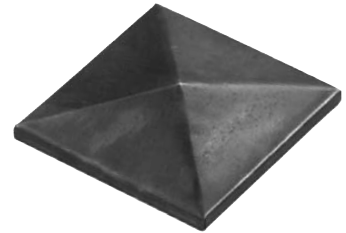

Art. 167/5
50 x 50 mm

Art. 167/7
80 x 80 mm

Art. 167/9
120 x 120 mm

Art. 167/10
150 x 150 mm



Hollow sphere
Sfera vuota

Art. 1165/4
Φ 55 x 55 mm
Ø 60 mm

Art. 1165/2
Φ 85 x 85 mm
Ø 90 mm

Art. 1165/1
Φ 105 x 105 mm
Ø 100 mm



Art. 158/B/11
Φ 12 x 12 mm
H 185 mm



CAST IRON - GHISA



Art. 1854/4
Ø 32 mm
H 400 mm



Art. 1854/5
Ø 32 mm
H 570 mm



Art. 1854/6
Ø 40 mm
H 680 mm



Rosaces *Rosoni*

Arteferro rosaces are particularly elaborate decorative elements that can be used to embellish external and internal environments like gates and grilles, balustrades, stairs, walls and skylights too.

I rosoni Arteferro sono elementi decorativi particolarmente elaborati che possono essere impiegato per abbellire ambienti esterni ed interni come cancelli ed inferriate ma anche parapetti, scale, pareti e lucernari.













arteferro



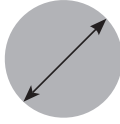

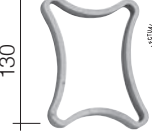

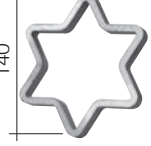







The rosaces have been listed by diameter: after identifying this dimension, it is enough to choose the section and then the art type

I rosoni sono stati catalogati per diametro: identificata tale dimensione, basterà scegliere la sezione e quindi la tipologia artistica.

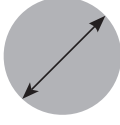











from-da Ø 112 mm to-a Ø 210 mm



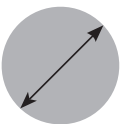



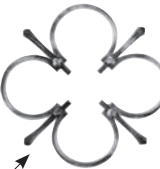



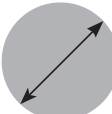

	plain liscio 	notched tacchettato 	notched tacchettato 	plain liscio 	plain liscio 	plain liscio 
	stamped stampato	without collars senza fascette	without collars senza fascette	stamped stampato	stamped stampato	stamped stampato
						
Section-Sezione	Ø 112 mm	Ø 150 mm	Ø 153 mm	Ø 160 mm	Ø 160 mm	Ø 210 mm
	Art.	Art.	Art.	Art.	Art.	Art.
Ø 6 x 6 mm	-	-	30/4	-	-	-
Ø 14 x 14 mm	1393/2	-	-	-	-	-
∇ 10 x 5 mm	-	-	-	30/7	-	-
∇ 12 x 6 mm	-	1323/6	-	-	1323/13	-
∇ 16 x 4 mm	-	-	-	-	-	453/2







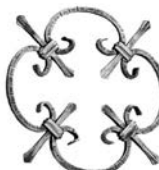

from-da Ø 210 mm to-a Ø 240 mm

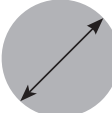









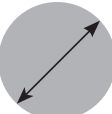

	plain liscio 	plain liscio 	diamond diamantato 	plain liscio 	plain liscio 	four-leaf clover quadrifoglio 
	stamped stampato					
						
Section-Sezione	Ø 210 mm	Ø 225 mm	Ø 230 mm	Ø 240 mm	Ø 240 mm	Ø 240 mm
	Art.	Art.	Art.	Art.	Art.	Art.
Ø 12 x 12 mm	-	-	-	-	1019/2	-
∇ 12 x 6 mm	453/3	-	1017/2	-	-	-
∇ 35 x 5 mm	-	31/3	-	-	-	-
Ø 12 mm	-	-	-	1019/1	-	1019/3

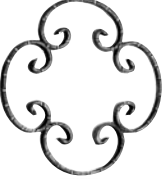







from-da Ø 245 mm to-a Ø 250 mm







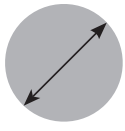
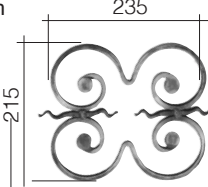
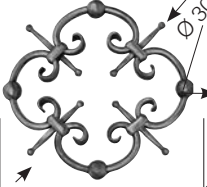
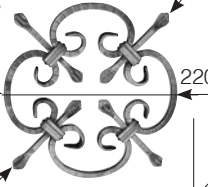

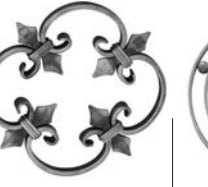
	plain liscio 	plain liscio 	notched tacchettato 	plain liscio 	plain liscio 	plain liscio 
	without collars senza fascette	with collars con fascette	without collars senza fascette	without collars senza fascette	with collars con fascette	without collars senza fascette
						
Section-Sezione	Ø 245 mm	Ø 245 mm	Ø 250 mm	Ø 250 mm	Ø 250 mm	Ø 250 mm
	Art.	Art.	Art.	Art.	Art.	Art.
Ø 8 x 8 mm	-	-	17/2	21/4	22/1	22/2
Ø 14 x 14 mm	-	1659/2	-	-	-	-
∇ 12 x 6 mm	453/4	-	-	-	-	-

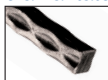
<p>from-da Ø 250 mm</p> 	<p>notched tacchettato</p>  <p>without collars senza fascette</p> 	<p>notched tacchettato</p>  <p>with collars con fascette</p> 	<p>notched tacchettato</p>  <p>without collars senza fascette</p> 	<p>notched tacchettato</p>  <p>without collars senza fascette</p> 	<p>notched tacchettato</p>  <p>without collars senza fascette</p> 	<p>notched tacchettato</p>  <p>without collars senza fascette</p> 
	Section-Sezione	Ø 250 mm	Ø 250 mm	Ø 250 mm	Ø 250 mm	Ø 250 mm
	Art.	Art.	Art.	Art.	Art.	Art.
Φ 8 x 8 mm	17/1	-	-	18/A/1	18/1	18/2
∅ 10 x 5 mm	-	23/1	-	-	-	-
∅ 12 x 6 mm	-	-	-	-	-	-
∅ 20 x 4 mm	-	-	23/2	-	-	-



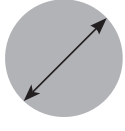



<p>from-da Ø 250 mm</p> 	<p>plain liscio</p>  <p>with collars con fascette</p> 	<p>plain liscio</p>  <p>without collars senza fascette</p> 	<p>plain liscio</p>  <p>without collars senza fascette</p> 	<p>plain liscio</p>  <p>without collars senza fascette</p> 
	Section-Sezione	Ø 250 mm	Ø 250 mm	Ø 250 mm
	Art.	Art.	Art.	Art.
Φ 8 x 8 mm	20/1	-	-	-
∅ 10 x 5 mm	-	-	-	-
∅ 20 x 3 mm	-	22/B/3	-	-
∅ 20 x 4 mm	-	-	23/2	26/4
∅ 20 x 6 mm	-	-	-	26/5

<p>from-da Ø 250 mm to-a Ø 260 mm</p> 	<p>plain liscio</p>  <p>without collars senza fascette</p> 	<p>notched tacchettato</p>  <p>without collars senza fascette</p> 	<p>plain liscio</p>  <p>without collars senza fascette</p> 	<p>plain liscio</p>  <p>without collars senza fascette</p> 	<p>plain liscio</p>  <p>without collars senza fascette</p> 	<p>notched tacchettato</p>  <p>without collars senza fascette</p> 
	Section-Sezione	Ø 250 mm	Ø 250 mm	Ø 250 mm	Ø 250 mm	250 x 250 mm
	Art.	Art.	Art.	Art.	Art.	Art.
Φ 12 x 12 mm	-	-	-	-	33/2	-
∅ 10 x 5 mm	-	22/B/1	-	-	33/3	-
∅ 12 x 6 mm	33/1	-	-	1653/1	-	-
∅ 14 x 8 mm	-	-	-	-	-	26/2
∅ 16 x 4 mm	-	-	30/2	-	-	-
Ø 12 mm	-	-	-	-	-	26/1





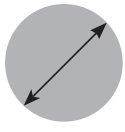

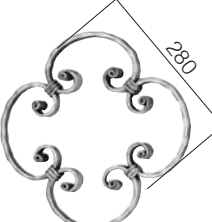
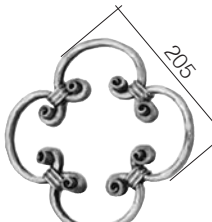



	plain liscio	plain liscio	notched tacchettato	plain liscio	plain liscio	plain liscio
						
	with collars con fascette	with collars con fascette	with collars con fascette			
from-da Ø 270 mm to-a Ø 275 mm						
Section-Sezione	Ø 270 mm	Ø 270 mm	Ø 275 mm	Ø 275 mm	Ø 275 mm	Ø 285 mm
	Art.	Art.	Art.	Art.	Art.	Art.
Φ 8 x 8 mm	27/4	-	1015/1	-	-	-
∅ 12 x 6 mm	-	-	-	21/5	-	1661/9
∅ 14 x 8 mm	-	-	-	-	1015/2	-
Ø 12 mm	-	1014/3	-	-	-	-

	diamond diamantato	plain liscio	plain liscio	plain liscio	plain liscio
					
from-da Ø 285 mm to-a Ø 295 mm					
Section-Sezione	Ø 285 mm	Ø 290 mm	Ø 295 mm	Ø 295 mm	Ø 295 mm
	Art.	Art.	Art.	Art.	Art.
Φ 12 x 12 mm	-	1010/3	-	-	1013/2
∅ 12 x 6 mm	1017/1	-	453/5	1323/1	1013/1
Ø 12 mm	-	-	-	-	-



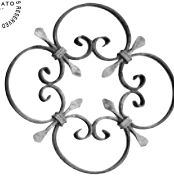

Rosettes 116/A/4 on both sides
Rosette 116/A/4 sui 2 lati

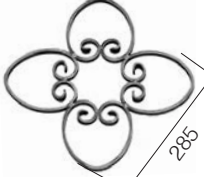
	plain liscio	plain liscio	four-leaf clover quadrifoglio	hammered spigolato	hammered spigolato
					
				with collars con fascette	with collars con fascette
from-da Ø 285 mm to-a Ø 295 mm					
Section-Sezione	Ø 315 mm	Ø 315 mm	Ø 315 mm	Ø 320 mm	Ø 320 mm
	Art.	Art.	Art.	Art.	Art.
Φ 12 x 12 mm	-	1019/5	-	-	-
∅ 16 x 8 mm	-	-	-	1648/2	1648/3
Ø 12 mm	1019/4	-	1019/6	-	-





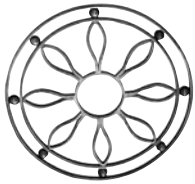
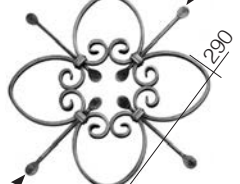
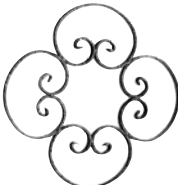
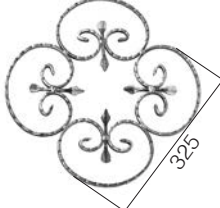

from-da Ø 325 mm to-a Ø 370 mm

	plain liscio	plain liscio	plain liscio	plain liscio	four-leaf clover quadrifoglio	plain liscio
						
	190	with collars con fascette				without collars senza fascette
						
Section-Sezione	Ø 325 mm	Ø 350 mm	Ø 360 mm	Ø 360 mm	Ø 360 mm	Ø 360 mm
	Art.	Art.	Art.	Art.	Art.	Art.
Φ 12 x 12 mm	-	-	-	1019/8	-	-
∅ 12 x 6 mm	-	446/1	-	-	-	1009/1
∅ 14 x 8 mm	GD187/2	-	-	-	-	-
Ø 12 mm	-	-	1019/7	-	1019/9	-

from-da Ø 370 mm to-a Ø 380 mm

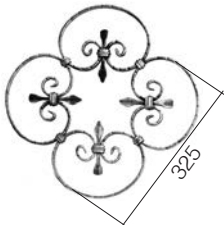
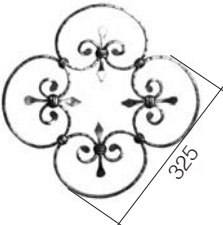
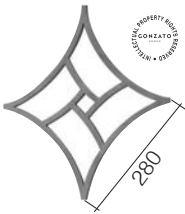
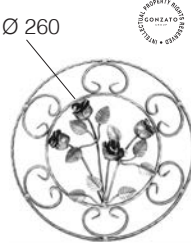

	plain liscio	plain liscio	notched tacchettato	notched tacchettato
				
		without collars senza fascette		without collars senza fascette
				
Section-Sezione	Ø 370 mm	Ø 370 mm	Ø 380 mm	Ø 380 mm
	Art.	Art.	Art.	Art.
∅ 10 x 5 mm	-	-	24/C/1	454/3
∅ 12 x 6 mm	1661/1	1009/2	-	-

from-da Ø 380 mm to-a Ø 420 mm

	notched tacchettato	notched tacchettato	plain liscio	diamond diamantato	plain liscio
					
	with collars con fascette	with collars con fascette			
					
Section-Sezione	Ø 380 mm	Ø 380 mm	Ø 395 mm	Ø 415 mm	Ø 420 mm
	Art.	Art.	Art.		
Φ 12 x 12 mm	-	-	GD211/2	-	-
∅ 10 x 5 mm	24/1	24/2	-	-	-
∅ 12 x 6 mm	-	-	-	720/2	450/1

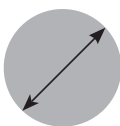



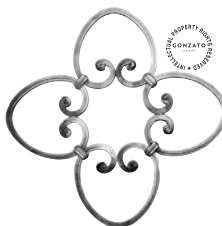
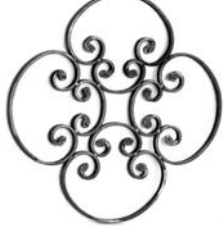

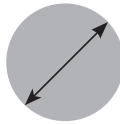

from-da Ø 430 mm
to-a Ø 440 mm



	 plain liscio with collars con fascette	 plain liscio	 plain liscio Rosettes 116/A/3 on both sides Rosette 116/A/3 sui 2 lati		
Section-Sezione	Ø 430 mm	Ø 440 mm	Ø 440 mm	Ø 445 mm	Ø 450 mm
		Art.	Art.	Art.	Art.
Φ 12 x 12 mm	-	-	-	1010/2	-
Φ 14 x 14 mm	-	-	1659/1	-	-
∅ 10 x 5 mm	-	-	-	-	24/C/3
∅ 12 x 6 mm	449/1	-	-	-	-
Ø 10 mm	-	1011/1	-	-	-



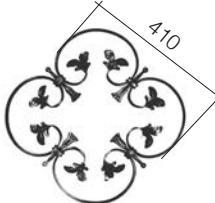

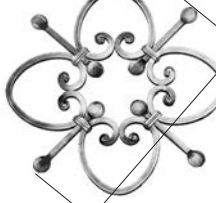

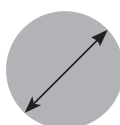

from-da Ø 450 mm
to-a Ø 490 mm





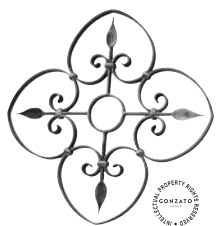

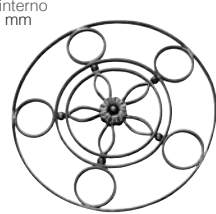

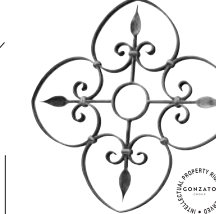





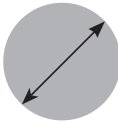

	 plain liscio	 plain liscio	 plain liscio	 plain liscio	 plain liscio
		 455 590 415	 410	 470 590 415	 490
Section-Sezione	Ø 450 mm	Ø 455 mm	Ø 460 mm	Ø 470 mm	Ø 490 mm
	Art.	Art.	Art.	Art.	
Φ 12 x 12 mm	-	-	-	-	1010/1
∅ 12 x 6 mm	-	-	24/B/1	-	-
∅ 14 x 8 mm	-	1667/1	-	1667/2	-
Ø 12 mm	455/2	-	-	-	-

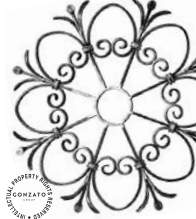

from-da Ø 500 mm
to-a Ø 560 mm



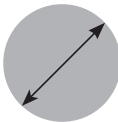

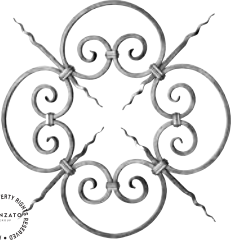



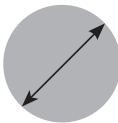
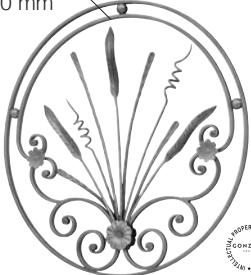
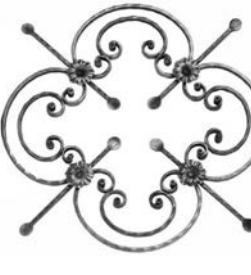







	 plain liscio Rosettes 116/A/3 on both sides Rosette 116/A/3 sui 2 lati	 plain liscio	 plain liscio	 plain liscio with collars con fascette	
	 inner circle cerchio interno Ø 450 mm			 450	
Section-Sezione	Ø 500 mm	Ø 500 mm	Ø 525 mm	Ø 560 mm	Ø 560 mm
	Art.	Art.	Art.	Art.	Art.
Φ 12 x 12 mm	-	-	-	-	1011/3
Φ 14 x 14 mm	-	-	-	-	-
∅ 12 x 6 mm	-	1661/5	-	-	-
∅ 14 x 8 mm	GD268/1	-	1668/2	-	-
∅ 20 x 6 mm	-	-	-	1639/1	-
Ø 14 mm	-	-	-	-	-

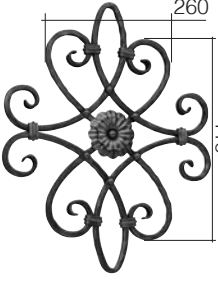







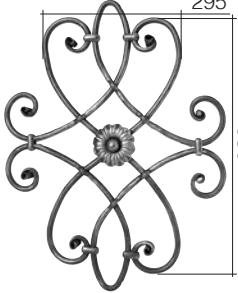
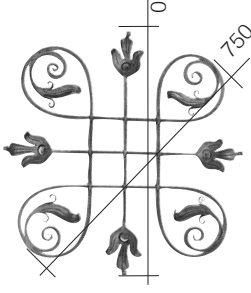
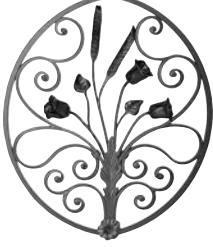

	plain liscio	diamond diamantato	plain liscio	plain liscio	martellato hammered
					
from-da Ø 560 mm to-a Ø 600 mm					
Section-Sezione	Ø 560 mm	Ø 565 mm	Ø 565 mm	Ø 590 mm	Ø 600 mm
	Art.	Art.	Art.	Art.	Art.
∅ 12 x 12 mm	-	1011/3	-	-	24/3
∅ 12 x 6 mm	-	-	-	1020/1	-
Ø 12 mm	1012/1	-	-	-	-
Ø 14 mm	-	-	446/4	-	-



	plain liscio	Bark effect Corteccia	power hammered magliato
			
from-da Ø 600 mm to-a Ø 620 mm			
Section-Sezione	Ø 600 mm	Ø 600 mm	Ø 610 mm
	Art.	Art.	Art.
∅ 12 x 12 mm	24/E/1	1012/2	459/1
∅ 14 x 8 mm	-	-	-
Ø 12 mm	-	-	-



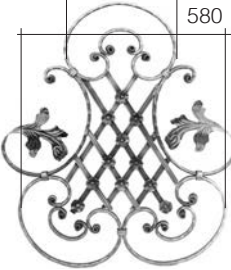

	plain liscio	plain liscio	plain liscio
			
from-da Ø 620 mm to-a Ø 650 mm			
Section-Sezione	Ø 620 mm	Ø 630 mm	Ø 650 mm
	Art.	Art.	Art.
∅ 12 x 12 mm	-	1028/2	-
∅ 12 x 6 mm	-	-	1642/1
∅ 14 x 8 mm	GD268/2	-	-
∅ 16 x 8 mm	-	-	1648/1

	plain liscio	plain liscio	plain liscio	hammered spigolato	plain liscio
					
from-da L 350 mm to-a L 430 mm					
	cast iron/ghisa				
Section-Sezione	L 350 x H 350 mm	L 410 x H 400 mm	L 400 x H 575 mm	L 430 x H 530 mm	L 430 x H 530 mm
	Art.	Art.	Art.	Art.	Art.
∅ 12 x 12 mm	-	-	-	26/C/1	1641/2
∅ 12 x 6 mm	34/1	-	-	1641/6	1641/5
∅ 16 x 8 mm	-	1657/1	1657/4	-	-

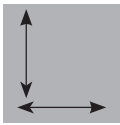
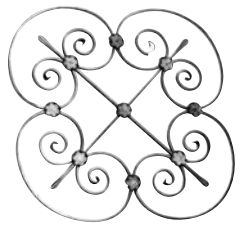
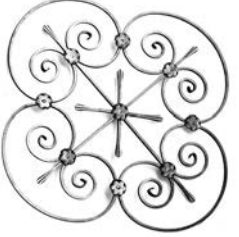
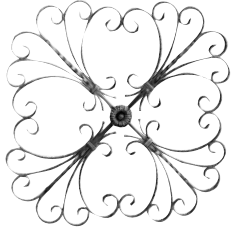
	plain liscio	plain liscio	plain liscio	plain liscio
				
from-da L 400 mm to-a L 600 mm				
	brass flower on two sides fiore in ottone su due lati			
Section-Sezione	L 400 x H 480 mm	L 475 x H 610 mm	L 590 x H 590 mm	L 600 x H 700 mm
	Art.	Art.	Art.	Art.
∅ 12 x 12 mm	160/E/4	-	-	-
∅ 14 x 14 mm	-	-	-	GD269/3
∅ 16 x 8 mm	-	-	680/2	-
∅ 14 mm	-	1641/1	-	-

	plain liscio	hammered spigolato	hammered spigolato	hammered spigolato	hammered spigolato
					
from-da L 410 mm to-a L 710 mm					
Section-Sezione	L 410 x H 610 mm	L 515 x H 670 mm	L 515 x H 690 mm	L 640 x H 710 mm	L 640 x H 710 mm
	Art.	Art.	Art.	Art.	Art.
∅ 14 x 14 mm	-	720/1	719/1	-	-
∅ 12 x 6 mm	1647/1	-	-	-	-
∅ 16 x 8 mm	-	-	-	719/2	GD269/1

	<p>plain liscio</p> 	<p>plain liscio</p> 	<p>plain liscio</p> 
<p>from-da L 810 mm to-a L 1020 mm</p> 			
Section-Sezione	L 810 x H 810 mm	L 810 x H 810 mm	L 1020 x H 1020 mm
	Art.	Art.	Art.
∅ 10 x 10 mm	26/B/1	26/B/2	457/1

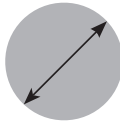
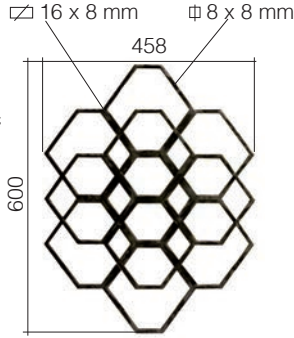
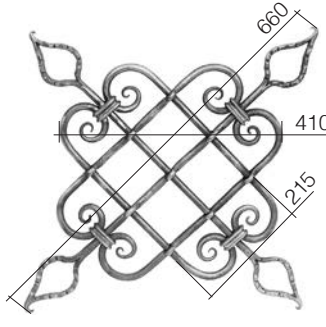
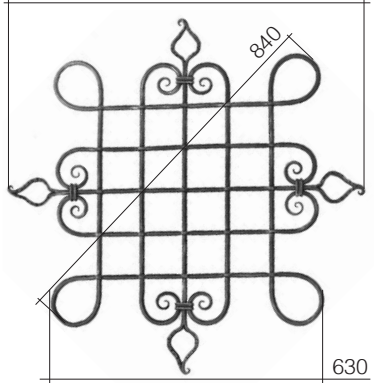
	<p>plain liscio</p> 	<p>plain liscio</p> 	<p>plain liscio</p> 	<p>plain liscio</p> 
<p>from-da ∅ 600 mm to-a ∅ 840 mm</p> 				
Section-Sezione	∅ 600 mm	∅ 660 mm	∅ 840 mm	
	Art.	Art.	Art.	
∅ 8 x 8 mm	GD299/4	-	-	
∅ 12 mm	-	679/1	679/2	



plain
liscio



plain
liscio



hammered
spigolato



from-da Ø 720 mm
to-a Ø 1045 mm

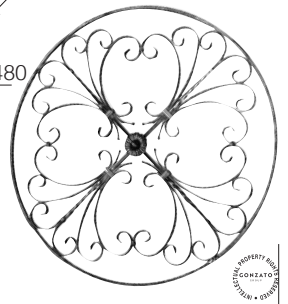
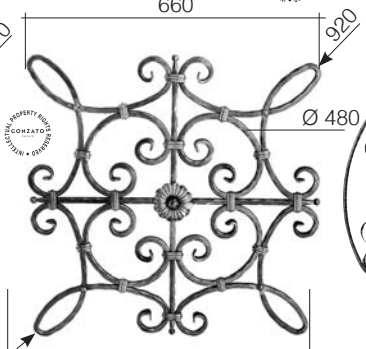
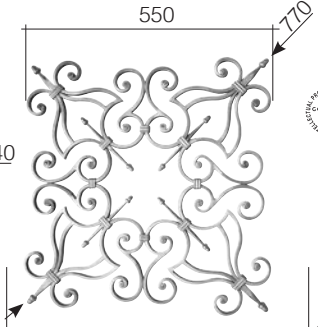
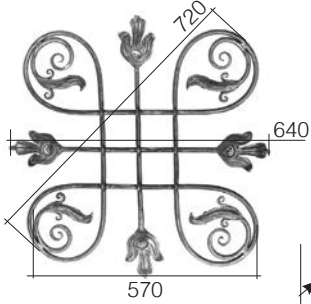
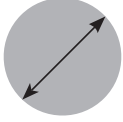

Section-Sezione	Ø 720 mm	Ø 770 mm	Ø 920 mm	Ø 1045 mm
	Art.	Art.	Art.	Art.
Ø 12 x 12 mm	-	-	480/1	-
Ø 12 x 6 mm	-	-	-	457/2
Ø 14 x 8 mm	-	GD151/2	-	-
Ø 12 mm	679/3	-	-	-



plain - liscio



**EXTENSIBLE ROSACES
"ARTICULATED"
ROSONI ESTENSIBILI
"SNODATI"**

In 1972
the first rosace
was sold as item no. 31,
today on sale as
art.no.18/2

Nel 1972
fu venduto
il primo rosone
art. 31 oggi in vendita
come art. 18/2

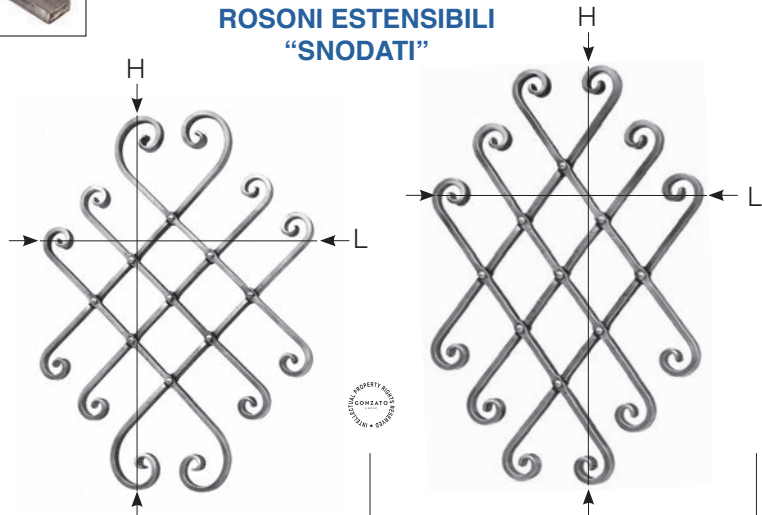

Section-Sezione	from-da L. 440 x H. 580 mm to-a L. 380 x H. 620 mm	from-da L. 440 x H. 490 mm to-a L. 360 x H. 550 mm
	Art.	Art.
∅ 16 x 8 mm	* 1658/1	* 1658/2

*articles not saleable in Spain
*articoli non vendibili in Spagna



from-da L 120 mm
to-a L 485 mm

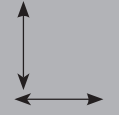

	plain liscio	plain liscio	plain liscio	hammered spigolato
Section-Sezione	L 120 x H 300 mm	L 150 x H 440 mm	L 250 x H 425 mm	L 460 x H 600 mm
	Art.	Art.	Art.	Art.
∅ 12 x 12 mm	-	-	-	460/2
∅ 12 x 6 mm	52/H/3	-	-	-
∅ 14 x 6 mm	-	1665/19	-	-
∅ 14 x 8 mm	-	-	471/2	-

CAST IRON - GHISA



Art. 756/1
265 x 460 mm
thickn./spess. 32 mm
threades/filetto M6

Art. 756/3
210 x 385 mm
thickn./spess. 32 mm
threades/filetto M6

Art. 756/7
170 x 300 mm
thickn./spess. 32 mm
threades/filetto M6



Art. 756/5
295 x 550 mm
thickn./spess. 23 mm
2 threades/filetto M5

Art. 756/10
195 x 470 mm
thickn./spess. 20 mm
2 threades/filetto M5



Art. 756/11
220 x 230 mm
thickn./spess. 20 mm





Scrolls and Snap-ons *Ricci e Snap-ons*

Arteferro scrolls and snap-ons have been designed to embellish even the simplest wrought iron composition. Like the other Arteferro decorative elements, they can be used in many different projects, from gates to the railings, as well as on stairways and balconies. Even a fence or a balustrade with vertical posts made of plain iron can be embellished at a later time by these useful decorative items.

I ricci e gli snap-ons Arteferro sono stati ideati per impreziosire anche la più semplice composizione in ferro battuto. Come gli altri elementi decorativi Arteferro, trovano applicazione in molteplici realizzazioni, dalla cancellate alle inferriate, così come nelle scale e nelle balconate. Anche una recinzione o un parapetto in paletti verticali di ferro liscio può essere arricchita in un secondo momento con l'utilizzo di questi utili elementi decorativi.

arteferro

10 Scrolls and Snap-ons Ricci e Snap-ons

10.A Scrolls pag.278

Ricci

10.B Snap-ons pag.306

This section will give you an overview of Arterferro scrolls. The main characteristic element of a scroll is the end. We have organised the items upon this, in accordance with their style or the manufacturing used. Once you've chosen the end, you can find your scroll.

Questo capitolo vi darà una panoramica dei ricci Arterferro. Principale elemento caratterizzante di un riccio è il terminale.

Su questo abbiamo organizzato gli articoli, in base allo stile o alla lavorazione. Scelto il terminale, trovi il tuo riccio.



Plain-Liscio
1368/2
Ø 8 x 8 mm

Cold cut ends
Terminali tranciati
a freddo

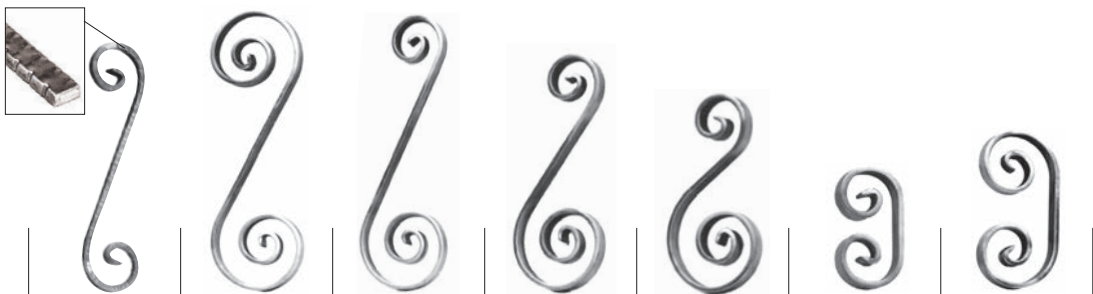

Section Sezione	L 75 mm H 305 mm Art.	L 120 mm H 360 mm Art.	L 120 mm H 360 mm Art.	L 120 mm H 290 mm Art.	L 108 mm H 220 mm Art.	L 60 mm H 115 mm Art.	L 90 mm H 180 mm Art.
Ø 8 x 8 mm	88/B/1	74/6	74/12	74/18	74/24	-	78/12
Ø 10 x 5 mm	-	-	74/7	74/13	74/19	78/1	78/7
Ø 12 x 6 mm	-	74/2	74/8	74/14	74/20	78/2	78/8
Ø 14 x 6 mm	-	74/25	74/27	74/26	74/28	78/14	78/13
Ø 16 x 4 mm	-	74/3	74/9	74/15	74/21	78/3	78/9
Ø 20 x 4 mm	-	74/4	74/10	74/16	74/22	78/4	78/10
Ø 20 x 6 mm	-	74/5	74/11	74/17	74/23	78/5	78/11



Plain-Liscio
1368/11
Ø 10 x 5 mm
1368/12
Ø 12 x 6 mm
1368/41
Ø 14 x 6 mm
1368/14
Ø 16 x 4 mm
1368/15
Ø 20 x 4 mm
1368/16
Ø 20 x 6 mm

Hot forged cut ends
Terminali fucinati
a caldo e tranciati



Section Sezione	L 65 mm H 150 mm Art.	L 70 mm H 190 mm Art.	L 125 mm H 360 mm Art.	L 70 mm H 105 mm Art.	L 75 mm H 130 mm Art.	L 95 mm H 140 mm Art.
Ø 12 x 4 mm	-	80/A/12/E	-	80/A/9/E	88/H/3/E	80/A/10/E
Ø 12 x 6 mm	80/A/11	80/A/12	-	-	-	-
Ø 14 x 6 mm	80/A/26	80/A/27	-	-	-	-
Ø 16 x 4 mm	80/A/19	80/A/20	-	-	-	-
Ø 20 x 4 mm	-	-	88/H/5	-	-	-



Plain-Liscio
1368/12
Ø 12 x 6 mm
1368/41
Ø 14 x 6 mm
1368/14
Ø 16 x 4 mm

Hot forged cut ends
Terminali fucinati
a caldo e tranciati

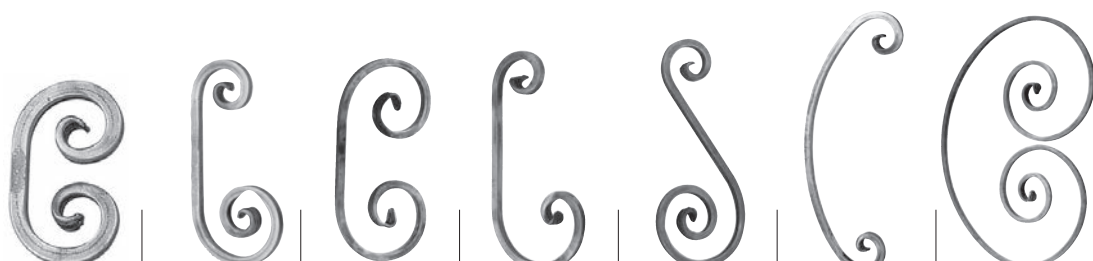

Section Sezione	L 60 mm H 120 mm Art.	L 120 mm H 220 mm Art.	L 120 mm H 240 mm Art.	L 130 mm H 265 mm Art.	L 120 mm H 270 mm Art.	L 130 mm H 360 mm Art.	L 325 mm H 450 mm Art.
Ø 10 x 10 mm	1297/14	1297/12	88/E/4	88/G/4	88/H/1	1297/15	88/E/3



Plain-Liscio
1368/3
Ø 10 x 10 mm

Hot forged cut ends
Terminali fucinati
a caldo e tranciati



Plain-Liscio
1368/12
12 x 6 mm
1368/41
14 x 6 mm
1368/14
16 x 4 mm

Section Sezione	L 75 mm H 120 mm Art.	L 75 mm H 160 mm Art.	L 75 mm H 130 mm Art.	L 75 mm H 150 mm Art.
12 x 6 mm	80/B/8	88/H/4	88/H/3	88/H/2
16 x 4 mm	80/B/3	-	-	-

Hot forged cut ends
Terminali fucinati
a caldo e tranciati



Plain-Liscio
1368/12
12 x 6 mm
1368/41
14 x 6 mm
1368/14
16 x 4 mm

Section Sezione	L 68 mm H 110 mm Art.	L 70 mm H 105 mm Art.	L 70 mm H 100 mm Art.	L 95 mm H 140 mm Art.
12 x 6 mm	80/A/31	80/A/9	80/A/32	80/A/10
14 x 6 mm	-	80/A/24	-	80/A/25
16 x 4 mm	-	80/A/17	-	80/A/18

Hot forged ends
Terminali fucinati
a caldo

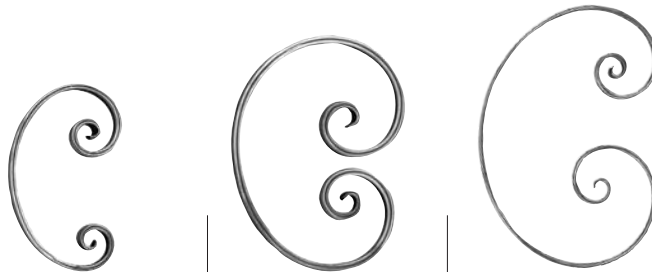

Grooved
Rigato
1369/2
16 x 8 mm

Section Sezione	L 150 mm H 210 mm Art.	L 190 mm H 260 mm Art.	L 300 mm H 440 mm Art.
16 x 8 mm	1283/7	1283/5	1283/4

Hot forged ends
Terminali fucinati
a caldo



Plain-Liscio
1368/12
12 x 6 mm
1368/41
14 x 6 mm
1368/14
16 x 4 mm

Section Sezione	L 65 mm H 150 mm Art.	L 75 mm H 150 mm Art.	L 75 mm H 160 mm Art.	L 130 mm H 210 mm Art.	L 80 mm H 145 mm Art.	L 65 mm H 260 mm Art.	L 80 mm H 290 mm Art.
12 x 4 mm	80/A/11/E	88/H/2/E	88/H/4/E	-	-	-	-
12 x 6 mm	-	-	-	80/C/12	88/A/2	80/C/16	80/C/15
14 x 6 mm	-	-	-	80/C/22	-	80/C/26	80/C/25

Hot forged ends
Terminali fucinati
a caldo

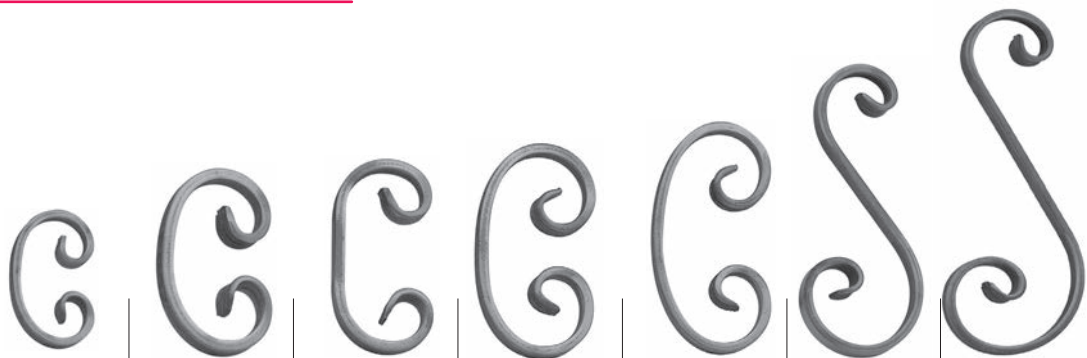

Section Sezione	L 65 mm H 95 mm Art.	L 70 mm H 110 mm Art.	L 60 mm H 120 mm Art.	L 80 mm H 130 mm Art.	L 80 mm H 145 mm Art.	L 80 mm H 190 mm Art.	L 100 mm H 260 mm Art.
∅ 12 x 6 mm	80/C/8	80/C/7	80/C/9	80/C/10	80/C/11	80/C/14	80/C/13
∅ 14 x 6 mm	80/C/18	80/C/17	80/C/19	80/C/20	80/C/21	80/C/24	80/C/23

Plain
Liscio

1368/12

∅ 12 x 6 mm

1368/41

∅ 14 x 6 mm

Hot forged cut ends
Terminali fucinati
a caldo e tranciati



Section Sezione	L 110 mm H 270 mm Art.	L 100 mm H 270 mm Art.	L 110 mm H 280 mm Art.	L 100 mm H 270 mm Art.
∅ 12 x 6 mm	80/A/1	80/A/2	80/A/5	80/A/4
∅ 14 x 6 mm	80/A/28	-	-	-
∅ 16 x 6 mm	80/A/14	-	-	-

Plain
Liscio

1368/12

∅ 12 x 6 mm

1368/41

∅ 14 x 6 mm

1368/14

∅ 16 x 4 mm

1368/43

∅ 16 x 6 mm

Hot forged cut ends
Terminali fucinati
a caldo e tranciati



Section Sezione	L 60 mm H 100 mm Art.	L 60 mm H 110 mm Art.	L 60 mm H 115 mm Art.	L 75 mm H 125 mm Art.	L 110 mm H 150 mm Art.
∅ 12 x 6 mm	80/A/6	80/A/3	80/A/7	80/A/8	80/A/13
∅ 14 x 6 mm	-	80/A/29	-	-	80/A/30
∅ 16 x 4 mm	-	80/A/22	-	-	80/A/23
∅ 16 x 6 mm	-	80/A/15	-	-	80/A/16

Plain
Liscio

1368/12

∅ 12 x 6 mm

1368/41

∅ 14 x 6 mm

1368/14

∅ 16 x 4 mm

1368/43

∅ 16 x 6 mm

BEST PRICE

Hot forged scroll
Venetian style
Riccio fucinato
a caldo "veneziana"



Section Sezione	L 90 mm H 145 mm Art.	L 95 mm H 150 mm Art.	L 105 mm H 220 mm Art.	L 105 mm H 220 mm Art.	L 105 mm H 300 mm Art.
∅ 12 x 12 mm	-	94/Q/5	94/P/1	94/Q/1	94/P/9
∅ 14 x 14 mm	88/I/3	94/Q/6	94/P/2	94/Q/2	94/P/10

∅ 12 x 12 mm	-	94/Q/7	94/P/3	94/Q/3	94/P/11
∅ 14 x 14 mm	88/I/2	94/Q/8	94/P/4	94/Q/4	94/P/12

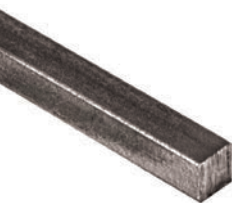

Plain-Liscio
1368/4
∅ 12 x 12 mm
1368/5
∅ 14 x 14 mm



118/1
∅ 12 x 12 mm
118/2
∅ 14 x 14 mm

Hot forged scroll
Venetian style
Riccio fucinato
a caldo "veneziana"



Section Sezione	L 65 mm H 105 mm Art.	L 110 mm H 160 mm Art.	L 185 mm H 160 mm Art.	L 180 mm H 445 mm Art.	L 240 mm H 455 mm Art.
∅ 12 x 12 mm	1046/7	1046/6	1046/4	1046/5	1046/3



Plain-Liscio
1368/4
∅ 12 x 12 mm

Hot forged ends
Terminali fucinati
a caldo



Section Sezione	L 190 mm H 385 mm Art.
∅ 12 x 12 mm	88/L/3



Hammered
Spigolato

118/1
∅ 12 x 12 mm

Hot forged scroll
Venetian style
Riccio fucinato
a caldo "veneziana"



Plain
Liscio
1368/8
∅ 10 mm

Section Sezione	L 130 mm H 270 mm Art.	L 180 mm H 400 mm Art.
∅ 10 mm	648/2	648/3



Hammered
Spigolato
625/8
Φ 12 x 12 mm

Hot forged scroll
Venetian style
Riccio fucinato
a caldo "veneziana"



Section Sezione	L 95 mm H 290 mm Art.	L 155 mm H 390 mm Art.
Φ 12 x 12 mm	635/2	635/4



Plain-Liscio
1368/4
Φ 12 x 12 mm
1368/5
Φ 14 x 14 mm

Hot forged scroll
Venetian style
Riccio fucinato
a caldo "veneziana"



Section Sezione	L 265 mm H 220 mm Art.	L 164 mm H 175 mm Art.	L 164 mm H 175 mm Art.
Φ 12 x 12 mm	-	94/P/5	94/P/7
Φ 14 x 14 mm	452/2	94/P/6	94/P/8



Hammered
Spigolato
118/1
Φ 12 x 12 mm
118/2
Φ 14 x 14 mm



**Diamond
Diamantato**
623/1
∅ 12 x 6 mm

Cold cut ends
Terminali tranciati
a freddo



Section Sezione	L 50 mm H 230 mm Art.
∅ 12 x 6 mm	1302/1

**Grooved
Rigato**
1369/2
∅ 16 x 8 mm

Cold cut ends
Terminali tranciati
a freddo



Section Sezione	L 110 mm H 140 mm Art.	L 100 mm H 160 mm Art.
∅ 16 x 8 mm	684/5	684/2

TUBE STEEL SCROLL
RICCIO IN TUBO

Plain-Liscio
1368/4
∅ 12 x 12 mm

Cold cut ends
Terminali tranciati
a freddo



Section Sezione	L 130 mm H 380 mm Art.
∅ 12 x 12 mm	651/4

**Cold cut ends
Terminali tranciati
a freddo**



Section Sezione	L 40 mm H 105 mm Art.	L 85 mm H 220 mm Art.
∅ 5 x 5 mm	628/6	628/2

**Arteferro
products
can be manufactured
as well as customised.**

**I prodotti Arteferro
sono realizzabili
anche su misura.**

**Hammered
Martellato**



Cold cut ends
Terminali tranciati
a freddo

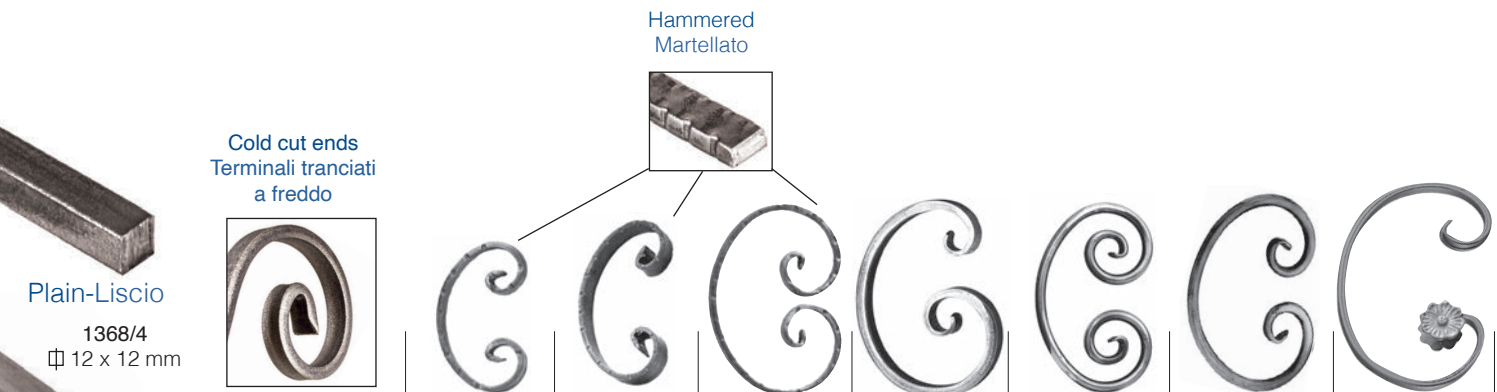

Section Sezione	L 75 mm H 125 mm Art.	L 72 mm H 130 mm Art.	L 135 mm H 185 mm Art.	L 155 mm H 205 mm Art.	L 140 mm H 215 mm Art.	L 160 mm H 225 mm Art.	L 210 mm H 350 mm Art.
∅ 12 x 12 mm	-	-	-	-	-	634/4	-
∅ 10 x 5 mm	82/1	-	85/4	-	-	-	-
∅ 16 x 8 mm	-	-	-	-	-	-	6115/1
∅ 20 x 4 mm	-	82/7	-	-	-	-	-
∅ 25 x 12 mm	-	-	-	1315/2	-	-	-
∅ 12 mm	-	-	-	-	634/5	-	-
∅ 14 mm	-	-	-	-	-	634/4	-

Plain-Liscio
1368/4
∅ 12 x 12 mm

Plain-Liscio
1368/44
∅ 16 x 8 mm

Plain-Liscio
1368/9
∅ 12 mm
1368/10
∅ 14 mm



Plain
Liscio
1368/12
Ø 12 x 6 mm
1368/14
Ø 16 x 4 mm

Hot forged ends
Terminali fucinati
a caldo



Section Sezione	L 50 mm H 375 mm Art.	L 87 mm H 460 mm Art.
Ø 12 x 6 mm	-	88/B/4
Ø 16 x 4 mm	80/B/1	-



Plain
Liscio
1368/35
Ø 30 mm

Hot forged ends
Terminali fucinati
a caldo



Section Sezione	L 200 mm H 200 mm Art.
Ø 30 mm	6020/1



Plain
Liscio
1368/12
Ø 12 x 6 mm

Hot forged cut ends
Terminali fucinati
a caldo e tranciati

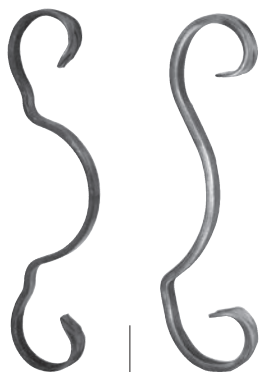

Section Sezione	L 65 mm H 240 mm Art.	L 60 mm H 240 mm Art.
Ø 12 x 6 mm	64/E/4	64/E/6



Plain
Liscio
1368/8
Ø 10 mm



Section Sezione	L 105 mm H 195 mm Art.
Ø 10 mm	1303/7



Plain
Liscio
1368/5
Ø 14 x 14 mm

Hot forged ends
Terminali fucinati
a caldo



Section Sezione	L 200 mm H 290 mm Art.	L 200 mm H 300 mm Art.	L 200 mm H 400 mm Art.
Ø 12 x 12 mm	85/7	-	-
Ø 14 x 14 mm	-	1039/2	1038/3



Hammered
Martellato
118/17
Ø 12 x 12 mm



Hammered
Spigolato
118/2
Ø 14 x 14 mm



Plain
Liscio
1368/8
Ø 10 mm



Section Sezione	L 90 mm H 125 mm Art.	L 90 mm H 125 mm Art.
Ø 10 mm	688/4	688/5

Hot forged ends
Baroque style
Terminali fucinati
a caldo "barocco"

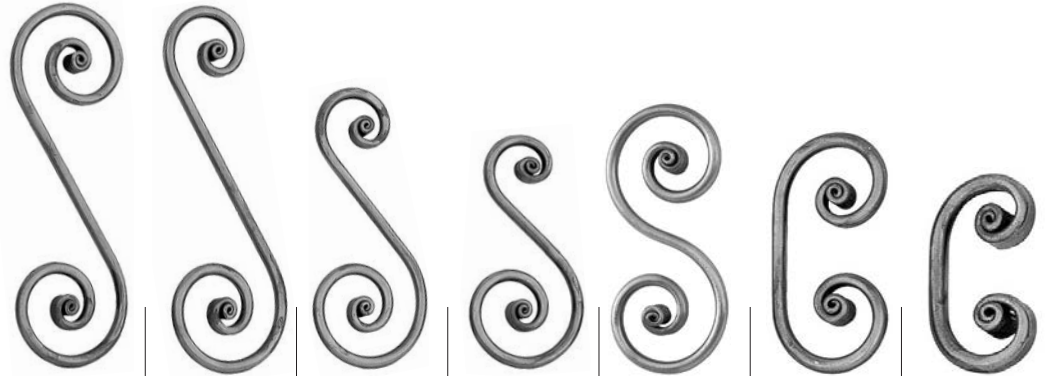

Plain-Liscio
1368/9
Ø 12 mm

Section Sezione	L 120 mm H 360 mm Art.	L 120 mm H 360 mm Art.	L 120 mm H 290 mm Art.	L 120 mm H 220 mm Art.	L 115 mm H 255 mm Art.	L 90 mm H 180 mm Art.	L 60 mm H 115 mm Art.
Ø 12 mm	1295/1	1295/2	1295/3	1295/4	1295/5	1295/6	1295/7

Hot forged ends
Baroque style
Terminali fucinati
a caldo "barocco"



Hammered
Battuto
600/4
Ø 12 mm

Section Sezione	L 120 mm H 260 mm Art.	L 95 mm H 260 mm Art.	L 100 mm H 260 mm Art.	L 90 mm H 135 mm Art.	L 70 mm H 110 mm Art.
Ø 12 mm	1296/9	1296/10	1296/11	1296/12	1296/13

Hot forged ends
Baroque style
Terminali fucinati
a caldo "barocco"

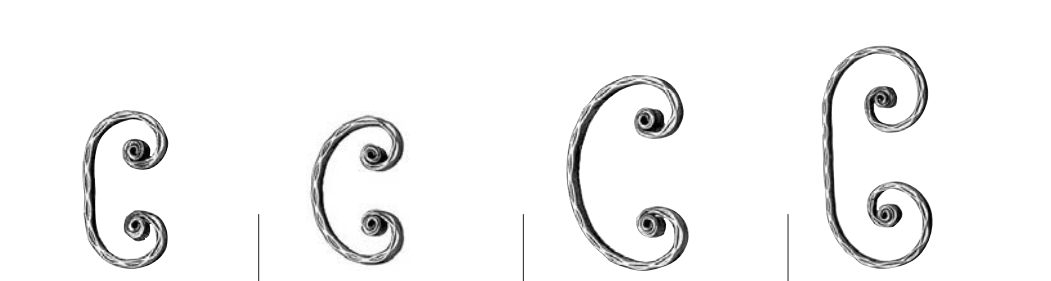

Diamond
Diamantato
623/1
12 x 6 mm

Section Sezione	L 60 mm H 115 mm Art.	L 70 mm H 115 mm Art.	L 90 mm H 140 mm Art.	L 90 mm H 180 mm Art.
12 x 6 mm	1296/6	1296/8	1296/7	1296/5

Hot forged ends
Baroque style
Terminali fucinati
a caldo "barocco"



Plain
Liscio
1368/12
12 x 6 mm
1368/41
14 x 6 mm
1368/14
16 x 4 mm
1368/43
16 x 6 mm

Section Sezione	L 120 mm H 290 mm Art.	L 120 mm H 360 mm Art.	L 120 mm H 350 mm Art.	L 90 mm H 180 mm Art.
16 x 4 mm	1294/3	1294/2	1294/6	1294/8

Hot forged ends
"baroque cut"
Terminali fucinati
a caldo
"barocco rifilato"



Section Sezione	L 70 mm H 130 mm Art.	L 140 mm H 210 mm Art.	L 100 mm H 220 mm Art.	L 120 mm H 280 mm Art.	L 120 mm H 330 mm Art.	L 120 mm H 390 mm Art.	L 60 mm H 310 mm Art.
∅ 14 x 8 mm	1301/10	1667/4	1301/5	1301/4	1301/2	1301/1	1667/5

Plain-Liscio
1368/13
∅ 14 x 8 mm

Hot forged ends
Baroque style
Terminali fucinati
a caldo "barocco"



Section Sezione	L 120 mm H 290 mm Art.	L 120 mm H 360 mm Art.	L 90 mm H 140 mm Art.
∅ 12 x 6 mm	-	-	NEW0066
∅ 14 x 8 mm	NEW0071	NEW0069	-

Plain-Liscio
1368/12
∅ 12 x 6 mm
1368/13
∅ 14 x 8 mm

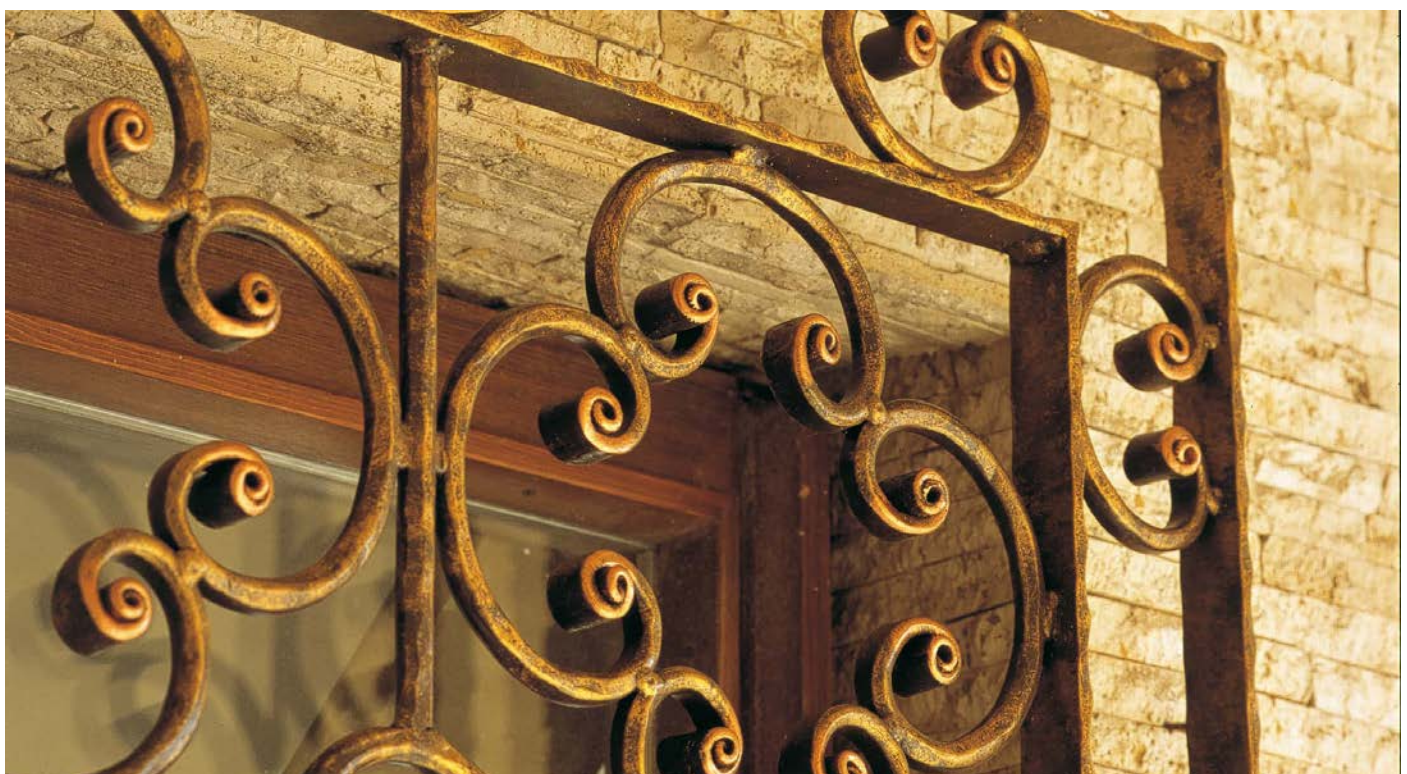

Hot forged ends
Terminali fucinati
a caldo



Section Sezione	L 80 mm H 130 mm Art.	L 80 mm H 160 mm Art.	L 130 mm H 290 mm Art.	L 110 mm H 220 mm Art.	L 110 mm H 220 mm Art.	L 110 mm H 300 mm Art.
∅ 12 x 12 mm	-	-	-	78/B/1	78/B/2	78/B/3
∅ 14 x 14 mm	-	-	-	-	78/B/5	78/B/6
∅ 14 x 8 mm	88/P/3	88/P/2	88/P/1	-	-	-

Plain-Liscio

- 1368/4
- ∅ 12 x 12 mm
- 1368/5
- ∅ 14 x 14 mm
- 1368/13
- ∅ 14 x 8 mm

Diamond
Diamantato



Cold stamped scrolls
Ricci stampati
a freddo



Section Sezione	L 70 mm H 110 mm Art.	L 73 mm H 123 mm Art.	L 80 mm H 130 mm Art.	L 80 mm H 150 mm Art.	L 90 mm H 160 mm Art.	L 135 mm H 185 mm Art.	L 145 mm H 225 mm Art.	L 125 mm H 250 mm Art.
∅ 10 x 5 mm	-	-	-	-	-	85/5	-	-
∅ 12 x 6 mm	88/A/3	88/10	87/1	87/6	87/5	-	88/A/5	88/9

Plain-Liscio

- 1368/11
- ∅ 10 x 5 mm
- 1368/12
- ∅ 12 x 6 mm

Cold stamped scrolls
Ricci stampati
a freddo

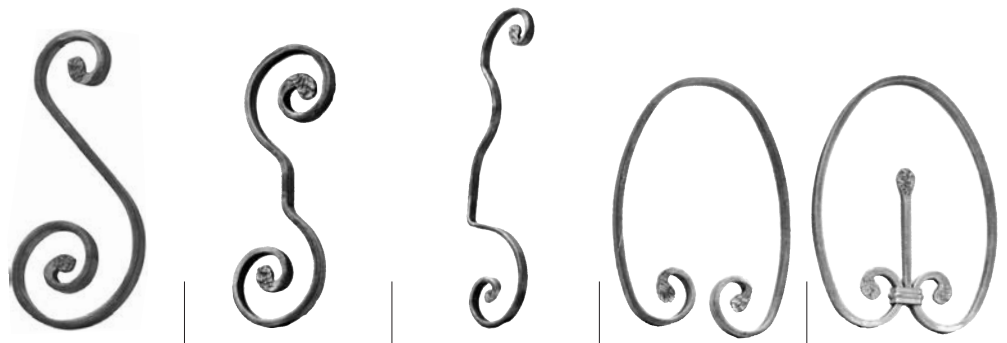

Section Sezione	L 95 mm H 210 mm Art.	L 75 mm H 220 mm Art.	L 85 mm H 350 mm Art.	L 165 mm H 220 mm Art.	L 160 mm H 220 mm Art.
∅ 12 x 6 mm	86/5	86/4	86/2	91/1	92/1

Plain-Liscio

- 1368/12
- ∅ 12 x 6 mm

Cold cut ends
Terminali tranciati
a freddo



Section Sezione	L 120 mm H 220 mm Art.	L 120 mm H 290 mm Art.	L 120 mm H 360 mm Art.	L 120 mm H 360 mm Art.
∅ 12 x 6 mm	641/5	641/6	641/7	641/8

Hot forged
scrolls
Ricci fucinati
a caldo



Section Sezione	L 70 mm H 105 mm Art.	L 70 mm H 130 mm Art.
∅ 12 x 6 mm	641/1	641/2

Diamond
Diamantato
623/1
∅ 12 x 6 mm

Hot forged ends
Terminali fucinati
a caldo



Section Sezione	L 120 mm H 290 mm Art.	L 120 mm H 360 mm Art.	L 120 mm H 360 mm Art.	L 190 mm H 440 mm Art.
∅ 10 mm	1297/3	1297/2	1297/1	645/7

Plain - Liscio
1368/8
∅ 10 mm

Hot forged ends
Terminali fucinati a caldo



Art. 64/G/4	Art. 64/G/5	Art. 64/G/3	Art. 64/G/6
∅ 12 x 6 mm 60 x 105 mm	∅ 12 x 6 mm 60 x 105 mm	∅ 12 x 6 mm 105 x 150 mm	∅ 12 x 6 mm 50 x 230 mm

Notched
Tacchettato
622/1
∅ 12 x 6 mm



Ends with sphere
Terminali
con pallina



Section Sezione	L 150 mm H 350 mm Art.	L 150 mm H 350 mm Art.	L 170 mm H 380 mm Art.
Φ 12 x 12 mm	1308/12	-	-
Φ 14 x 14 mm	-	-	-
Ø 12 mm	-	-	-
Ø 14 mm	-	1308/8	-
Ø 16 mm	-	1308/9	1308/10

Hot forged ends
Terminali fucinati
a caldo



Hammered
Spigolato

Section Sezione	L 180 mm H 360 mm Art.	L 180 mm H 360 mm Art.
Φ 12 x 12 mm	1308/1	1308/3
Φ 14 x 14 mm	1308/2	1308/4
Ø 12 mm	-	-
Ø 14 mm	1308/11	-
Ø 16 mm	1308/7	-

Hot forged ends
Terminali fucinati
a caldo



Section Sezione	L 65 mm H 130 mm Art.	L 80 mm H 130 mm Art.
Φ 12 x 12 mm	658/8	658/7
Ø 12 mm	659/11	659/10

Hot forged end
Terminale fucinato
a caldo



Section Sezione	L 60 mm H 110 mm Art.	L 110 mm H 270 mm Art.
∅ 12 x 6 mm	88/N/6	88/N/3



Notched
Tacchettato
622/1
∅ 12 x 6 mm



Hot forged scroll
Riccio battuti
a caldo



Art. 78/15
∅ 30 x 8 mm
60 x 130 mm









*Notched
Tacchettato
622/2
Φ 8 x 8 mm



Plain - Liscio
1368/14
∅ 16 x 4 mm
1368/16
∅ 20 x 6 mm

Cold cut ends
Terminali tranciati
a freddo





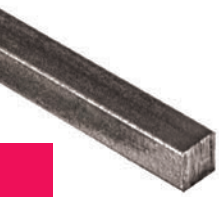



						
Section Sezione	L 60 mm H 115 mm Art.	L 90 mm H 180 mm Art.	L 73 mm H 122 mm Art.	L 70 mm H 140 mm Art.	L 150 mm H 225 mm Art.	L 90 mm H 240 mm Art.
Φ 8 x 8 mm	-	-	*81/5	-	-	-
∅ 14 x 6 mm	*88/N/12	*88/N/11	-	-	-	-
∅ 16 x 4 mm	-	-	-	84/6	-	84/2
∅ 20 x 6 mm	-	-	-	-	84/7	-



Plain - Liscio
1368/2
Φ 8 x 8 mm

Cold stamped scrolls
Ricci stampati a freddo









					
Section Sezione	L 85 mm H 115 mm Art.	L 73 mm H 122 mm Art.	L 105 mm H 235 mm Art.	L 140 mm H 205 mm Art.	Art. 90/1 ∅ 10 x 5 mm 155 x 180 mm
Φ 8 x 8 mm	81/1	* 81/3	83/1	645/3	



Plain - Liscio
1368/2
Φ 8 x 8 mm

Cold stamped scrolls
Ricci stampati a freddo



						
Section Sezione	L 110 mm H 230 mm Art.	L 110 mm H 300 mm Art.	L 80 mm H 180 mm Art.	L 100 mm H 390 mm Art.	L 70 mm H 430 mm Art.	L 225 mm H 540 mm Art.
Φ 8 x 8 mm	73/2	73/1	73/3	-	645/1	645/2
Φ 12 x 12 mm	-	-	-	38/8	-	-

Cold stamped scrolls
Ricci stampati
a freddo



Plain - Liscio
1368/8
Ø 10 mm

Section Sezione	L 270 mm H 130 mm Art.	L 300 mm H 400 mm Art.	L 150 mm H 210 mm Art.	L 315 mm H 475 mm Art.
Ø 10 mm	642/3	1291/2	1291/3	1291/1

Cold stamped scrolls
Ricci stampati
a freddo



Plain - Liscio
1368/8
Ø 10 mm

Section Sezione	L 110 mm H 230 mm Art.	L 110 mm H 300 mm Art.	L 400 mm H 180 mm Art.	L 210 mm H 280 mm Art.
Ø 10 mm	1290/2	1290/1	642/4	1291/4



Hammered
4 edges
Spigolato
4 spigoli
1839/24
16 x 8 mm

Hot forged ends
Baroque style
Terminali fucinati
a caldo "barocco"

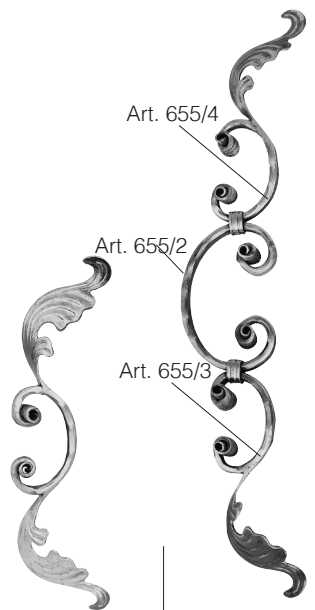

Section Sezione	L 70 mm H 120 mm Art.	L 100 mm H 160 mm Art.	L 400 mm H 70 mm Art.	L 110 mm H 690 mm Art.
16 x 8 mm	655/1	655/2	656/2	656/1



Plain - Liscio

- 1368/12
- ∅ 12 x 6 mm
- 1368/14
- ∅ 16 x 4 mm
- 1368/15
- ∅ 20 x 4 mm

Cold cut ends
Terminali tranciati
a freddo



Section Sezione	L 100 mm H 320 mm Art.
∅ 12 x 6 mm	76/1
∅ 16 x 4 mm	76/2
∅ 20 x 4 mm	76/3

Cold cut ends
Terminali tranciati
a freddo



- Plain
Liscio
- 1368/2
 - ∅ 8 x 8 mm
 - 1368/11
 - ∅ 10 x 5 mm
 - 1368/12
 - ∅ 12 x 6 mm

Sezione	L 125 mm H 350 mm Art.
∅ 10 x 5 mm	75/31
∅ 12 x 6 mm	75/32
∅ 8 x 8 mm	75/33



Hammered
Battuto

Art. 600/2
∅ 8 mm

Hot forged ends
Terminali fucinati
a caldo



Sezione	L 120 mm H 220 mm Art.	L 250 mm H 900 mm Art.	L 100 mm H 900 mm Art.
∅ 8 mm	646/5	-	-
∅ 12 mm	-	646/1	646/2



Plain - Liscio

- 1368/49
- ∅ 20 x 10 mm
- 1368/73
- ∅ 40 x 10 mm

Hot forged scroll
Venetian style
Riccio fucinato
a caldo "veneziana"



Section Sezione	L 112 mm H 339 mm Art.	L 200 mm H 470 mm Art.
∅ 20 x 10 mm	630/1	630/10



Plain - Liscio

1368/13

14 x 8 mm

Hot forged ends
"baroque cut"
Terminali fucinati
a caldo
"barocco rifilato"

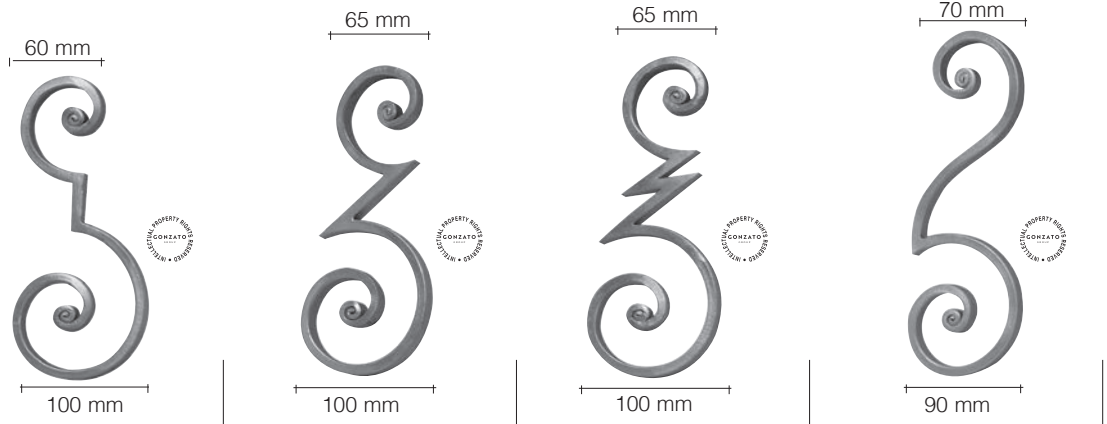

Sezione	L 100 mm H 220 mm Art.	L 100 mm H 230 mm Art.	L 100 mm H 237 mm Art.	L 95 mm H 270 mm Art.
14 x 8 mm	GD263/3	GD262/3	GD262/4	GD263/1

Plain - Liscio

1368/13

14 x 8 mm

Hot forged ends
"baroque cut"
Terminali fucinati
a caldo
"barocco rifilato"

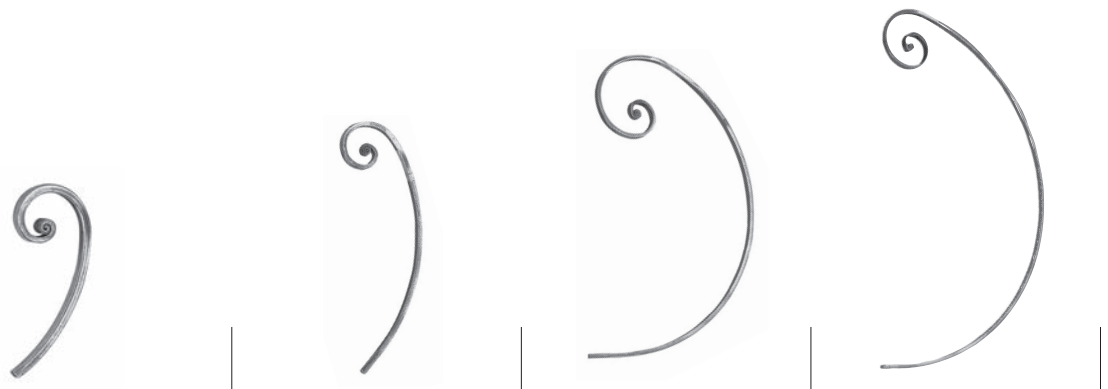

Sezione	L 75 mm H 180 mm Art.	L 115 mm H 500 mm Art.	L 315 mm H 560 mm Art.	L 370 mm H 710 mm Art.
14 x 8 mm	GD264/5	GD264/3	GD264/5	GD264/1

Arteferro
products
can be manufactured
as well as customised.

I prodotti Arteferro
sono realizzabili
anche su misura.

Hot forged cut ends
Terminali fucinati
a caldo rifilati

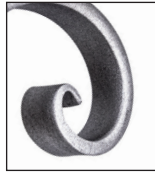

Section Sezione	L 60 mm H 100 mm Art.	L 75 mm H 125 mm Art.	L 70 mm H 190 mm Art.	L 125 mm H 260 mm Art.	L 130 mm H 260 mm Art.	L 130 mm H 350 mm Art.
1368/43 16 x 6 mm	1294/10	1294/11	1294/12	1294/13	1294/14	1294/15



left - sinistro

Art. 686/7
Ø 12 mm
L 180 mm
H 240 mm
Art. 686/9
Ø 12 mm
L 270 mm
H 350 mm



right - destro

Art. 686/11
Ø 12 mm
L 180 mm
H 240 mm
Art. 686/13
Ø 12 mm
L 270 mm
H 350 mm



left - sinistro

Art. 686/2
Ø 12 mm
L 100 mm
H 130 mm



right - destro

Art. 686/5
Ø 12 mm
L 100 mm
H 130 mm







left - sinistro







Art. 686/15
Ø 12 mm
L 100 mm
H 120 mm

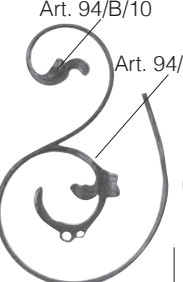
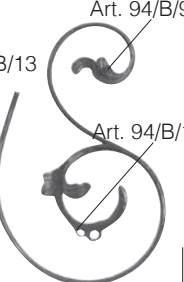

right - destro

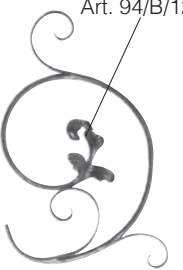
Art. 686/16
Ø 12 mm
L 100 mm
H 120 mm

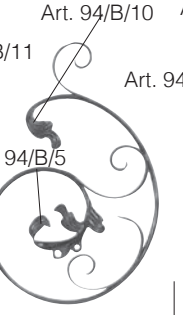
						
	right - destro	left - sinistro	right - destro	left - sinistro	right - destro	left - sinistro
Section Sezione	L 280 mm H 390 mm Art.	L 280 mm H 390 mm Art.	L 330 mm H 370 mm Art.	L 330 mm H 370 mm Art.	L 330 mm H 510 mm Art.	L 330 mm H 510 mm Art.
Ø 12 mm	94/C/9	94/C/10	94/C/11	94/C/12	94/C/13	94/C/14

						
	right - destro	left - sinistro	right - destro	left - sinistro	right - destro	left - sinistro
Section Sezione	L 440 mm H 460 mm Art.	L 440 mm H 460 mm Art.	L 310 mm H 540 mm Art.	L 310 mm H 540 mm Art.	L 410 mm H 620 mm Art.	L 410 mm H 620 mm Art.
Ø 12 mm	94/E/1	94/E/2	94/E/4	94/E/3	94/E/5	94/E/6

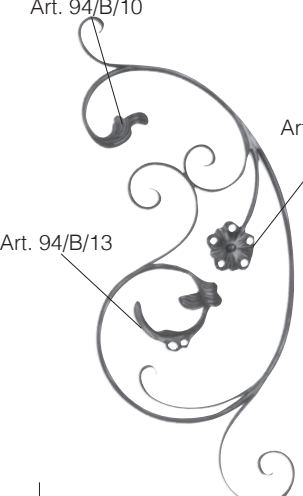
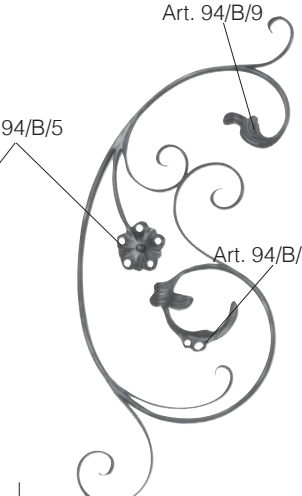
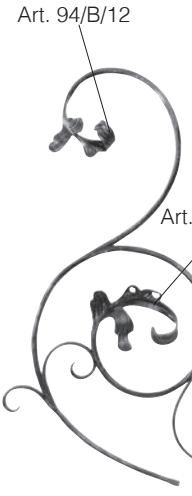
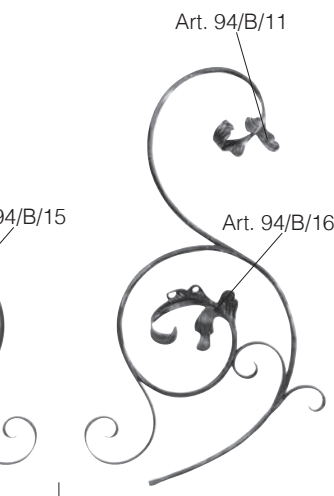
				
	right - destro	left - sinistro	right - destro	left - sinistro
Section Sezione	L 420 mm H 970 mm Art.	L 420 mm H 970 mm Art.	L 490 mm H 800 mm Art.	L 490 mm H 800 mm Art.
Ø 12 mm	94/F/6	94/F/5	94/F/4	94/F/3

Section Sezione	L 150 mm H 200 mm Art.	L 150 mm H 200 mm Art.	L 160 mm H 250 mm Art.	L 200 mm H 300 mm Art.	L 230 mm H 350 mm Art.	L 320 mm H 450 mm Art.
∅ 12 x 6 mm	94/2	94/3	92/B/4	93/2	93/4	93/1



Art. 92/B/3
∅ 12 x 6 mm
80 x 350 mm



Art. 93/3
∅ 12 x 6 mm
200 x 450 mm



Art. 92/D/5
∅ 12 x 6 mm
120 x 255 mm

Arteferro scrolls from the 94 line adorn the balconies of the Chechen government headquarters in Grozny

I ricci Arteferro della linea 94 ornano i parapetti della sede del governo ceceno a Grozny



Art. 94/C/2
∅ 16 x 2,5 mm
140 x 170 mm



Art. 94/C/1
∅ 16 x 2,5 mm
78 x 140 mm



Art. 94/C/4
∅ 10 mm
110 x 170 mm



Art. 94/C/3
∅ 10 mm
110 x 170 mm



Art. 94/C/6
∅ 10 mm
190 x 270 mm



Art. 94/C/5
∅ 10 mm
190 x 270 mm



Art. 658/3
∅ 12 x 12 mm
210 x 300 mm



Art. 682/10
∅ 16 x 8 mm
300 x 400 mm



Grooved
Rigato



Art. 24/F/2
∅ 12 x 12 mm
H 220 mm
L 300 mm



Art. 458/1
∅ 14 x 14 mm
H 210 mm
L 300 mm

power hammered
Magliato



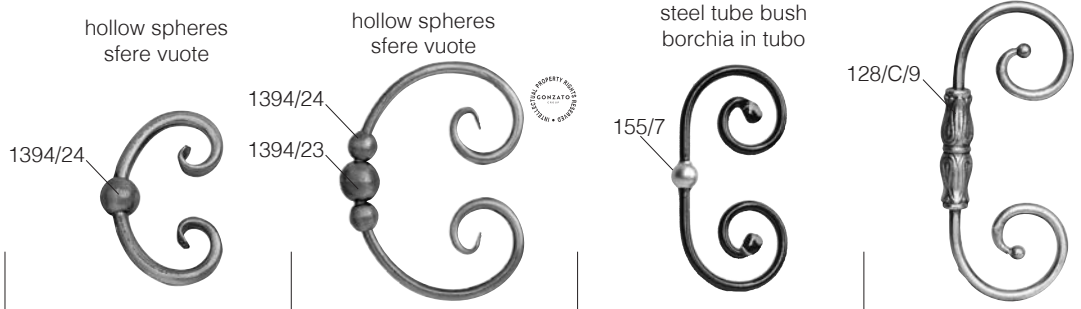

Section Sezione	L 90 mm H 135 mm Art.	L 180 mm H 230 mm Art.	L 120 mm H 250 mm Art.	L 130 mm H 300 mm Art.
Ø 12 mm	1212/4	1212/3	152/4	596/4

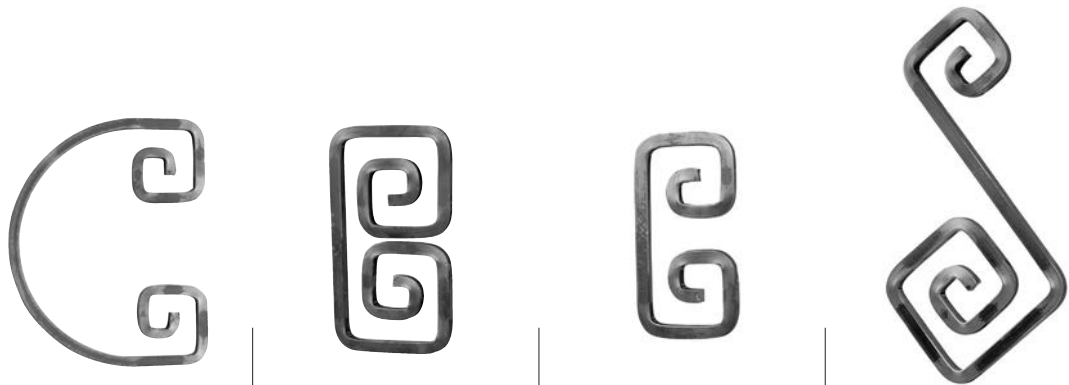

Section Sezione	L 195 mm H 280 mm Art.	L 120 mm H 215 mm Art.	L 95 mm H 185 mm Art.	L 170 mm H 335 mm Art.
Ø 12 x 12 mm	1145/1	1144/1	1144/2	1144/5



Cold cut ends
Terminali tranciati
a freddo



Plain-Liscio

- 1368/14
- ∅ 16 x 4 mm
- 1368/15
- ∅ 20 x 4 mm
- 1368/16
- ∅ 20 x 6 mm

Section Sezione	L 330 mm H 350 mm Art.	L 260 mm H 640 mm Art.	L 260 mm H 640 mm Art.	L 120 mm H 720 mm Art.	L 235 mm H 720 mm Art.	L 235 mm H 820 mm Art.
∅ 30 x 30 mm	1809/5					
∅ 16 x 4 mm	-	-	-	79/7	-	-
∅ 20 x 4 mm	-	-	-	-	-	88/C/3
∅ 20 x 6 mm	-	-	-	-	88/C/2	-
∅ 25 x 12 mm	-	1808/3	1315/1	-	-	-

HOT FORGEDS
FORGIATI

Hot forged cut ends
Terminali fucinati
a caldo rifilati



Plain-Liscio

- 1368/95
- ∅ 60 x 20 mm

Section Sezione	L 500 mm H 370 mm Art.	L 330 mm H 260 mm Art.	L 160 mm H 320 mm Art.
∅ 60 x 20 mm	1314/1	1314/2	1314/3



HOT FORGEDS
FORGIATI



Hammered
Spigolato

118/1
∅ 12 x 12 mm
118/6
∅ 25 x 25 mm



Plain - Liscio

1368/9
∅ 12 mm

Hot forged ends
Terminali fucinati
a caldo

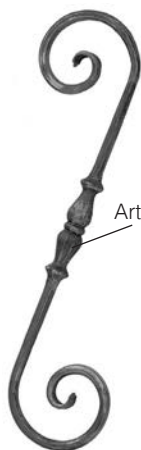

Art. 497/1



Art. 105/2



Art. 98/1

Section Sezione	L 110 mm H 450 mm Art.	L 110 mm H 450 mm Art.	L 110 mm H 450 mm Art.
∅ 12 x 12 mm	-	1309/4	-
∅ 25 x 25 mm	-	-	1309/5
∅ 12 mm	1309/1	-	-





Hammered
Spigolato
118/1
Φ 12 x 12 mm



Grooved
Rigato
1369/2
16 x 8 mm



Plain
Liscio
1368/9
Ø 12 mm



Plain
Liscio
626/12
Φ 14 x 14 mm



Plain
Liscio
1368/4
Φ 12 x 12 mm
1368/5
Φ 14 x 14 mm



Hammered
Spigolato
118/1
Φ 12 x 12 mm



Hot forged ends
Terminali fucinati
a caldo



Section Sezione	L 265 mm H 630 mm Art.	L 250 mm H 720 mm Art.	L 335 mm H 815 mm Art.	L 370 mm H 900 mm Art.	L 270 mm H 1000 mm Art.
Φ 12 x 12 mm	-	-	-	634/2	-
Φ 14 x 14 mm	-	-	-	-	1298/1
16 x 8 mm	1283/3	-	1283/1	-	-
Ø 12 mm	-	540/1	-	-	-



Hot forged ends
Terminali fucinati
a caldo



Section Sezione	L 280 mm H 600 mm Art.	L 250 mm H 720 mm Art.	L 270 mm H 820 mm Art.	L 250 mm H 900 mm Art.	L 250 mm H 900 mm Art.
Φ 12 x 12 mm	72/4	71/1	-	-	71/3
Φ 14 x 14 mm	-	-	-	78/B/11	-
Φ 20 x 20 mm	-	-	1811/13	-	-

BIG CROLLS - RICCI GRANDI



Plain
Liscio
1368/20
∅ 16 x 16 mm

Hot forged ends
Terminali fucinati
a caldo



Section Sezione	L 280 mm H 720 mm Art.	L 335 mm H 750 mm Art.	L 335 mm H 790 mm Art.
∅ 16 x 16 mm	1811/9	1811/10	-
∅ 20 x 20 mm	-	-	1811/11



Grooved and hamm.
4 sides
Rigato e spigolato
4 lati
625/8
∅ 12 x 12 mm
625/9
∅ 16 x 16 mm

Hot forged scroll
Venetian style
Riccio fucinato
a caldo "veneziana"



Section Sezione	L 160 mm H 445 mm Art.	L 255 mm H 470 mm Art.	L 160 mm H 610 mm Art.	L 160 mm H 635 mm Art.	L 240 mm H 640 mm Art.	L 280 mm H 720 mm Art.	L 200 mm H 1200 mm Art.
∅ 12 x 12 mm	1811/5	-	-	-	636/6	-	636/1
∅ 16 x 16 mm	-	639/2	1811/3	1811/8	-	639/1	-



Art. 629/6
∅ 12 x 6 mm
H 400 mm
L 125 mm



Art. 3002/6
∅ 14 x 14 mm
H 530 mm
L 215 mm

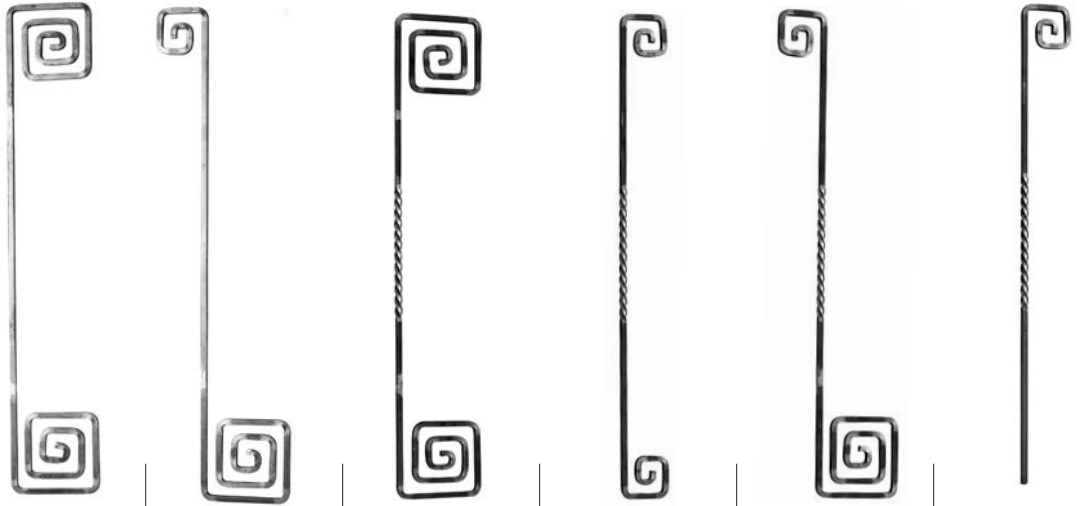

Section Sezione	L 185 mm H 1000 mm Art.	L 280 mm H 1000 mm Art.	L 185 mm H 1000 mm Art.	L 110 mm H 1000 mm Art.	L 280 mm H 1000 mm Art.	L 110 mm H 1000 mm Art.
∅ 12 x 12 mm	1146/1	1146/3	1147/1	1147/2	1147/3	1147/5



Ends with sphere
Terminali
con pallina

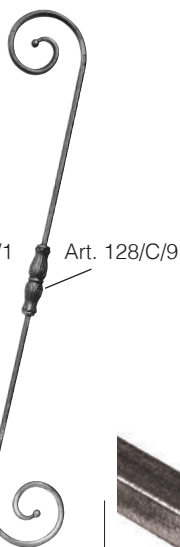
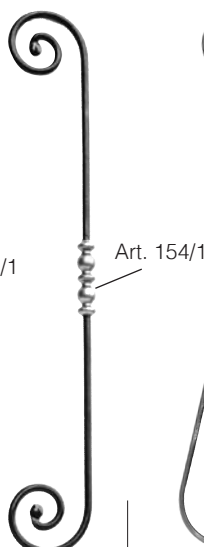
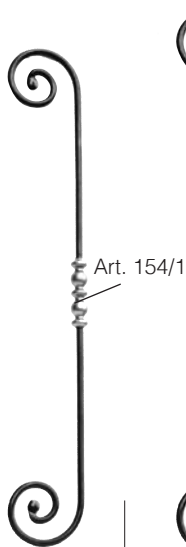
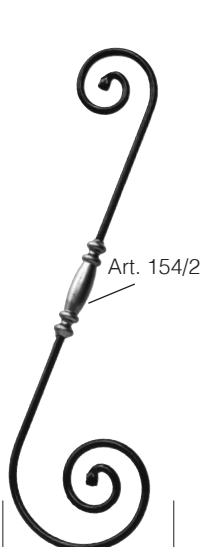

Cold stamped scrolls
Ricci stampati a freddo



Plain
Liscio
1368/9
Ø 12 mm

Section Sezione	L 200 mm H 720 mm Art.	L 130 mm H 720 mm Art.	L 130 mm H 900 mm Art.	L 150 mm H 900 mm Art.
Ø 12 mm	152/1	152/5	152/7	596/2

Plain
Liscio
1368/2
Φ 8 x 8 mm

Section Sezione	L 120 mm H 900 mm Art.
Φ 8 x 8 mm	6020/1



GHISA - CAST IRON

saldabile, non zincabile
weldable - galvanizing is not recommended



Art. 753/1
 \varnothing 12 x 12 mm
 H 380 mm
 L 195 mm



Art. 753/2
 \varnothing 12 x 12 mm
 H 305 mm
 L 165 mm



Art. 753/3
 \varnothing 12 x 12 mm
 H 450 mm
 L 190 mm



Art. 753/4
 \varnothing 12 x 12 mm
 H 360 mm
 L 165 mm



Art. 753/5
 \varnothing 16 mm
 H 275 mm
 L 130 mm



Art. 753/6
 \varnothing 16 mm
 H 195 mm
 L 125 mm



Art. 753/7
 \varnothing 16 mm
 H 170 mm
 L 145 mm



Art. 753/9
 \varnothing 12 x 12 mm
 H 105 mm
 L 105 mm



Hot forged
plain ends
Terminali fucinati
a caldo lisci



Hot forged
plain ends
Terminali fucinati
a caldo lisci



Section Sezione	L 180 mm H 180 mm Art.	L 190 mm H 190 mm Art.	L 210 mm H 210 mm Art.	L 210 mm H 210 mm Art.
∅ 14 x 14 mm	1665/10	-	1665/14	* 1665/12
∅ 16 x 16 mm	1665/11	* 1665/9	1665/15	* 1665/13

* articles not saleable in Spain
coupled on edge

* articoli non vendibili in Spagna
accoppiati su spigolo

* articles not saleable in Spain

* articoli non vendibili in Spagna

Plain - Liscio

1368/5

∅ 14 x 14 mm

1368/20

∅ 16 x 16 mm

Hot forged ends
Venetian style
Terminali fucinati
a caldo con veneziana



Hot forged ends
Venetian style
Terminali fucinati
a caldo con veneziana



Hot forged
plain ends
Terminali fucinati
a caldo lisci



Section Sezione	L 85 mm H 110 mm Art.	L 100 mm H 340 mm Art.	L 200 mm H 340 mm Art.	L 200 mm H 390 mm Art.	L 180 mm H 380 mm Art.	L 180 mm H 380 mm Art.
∅ 14 x 14 mm	1665/1	1665/3	1665/18	1665/16	* 1665/6	1665/4
∅ 16 x 16 mm	-	-	-	1665/17	* 1665/7	1665/5

TO BE LAID OVERLAPPED ON $\varnothing 12 \times 12 \text{ mm}$
DA SOVRAPPORRE AL $\varnothing 12 \times 12 \text{ mm}$

Notched
Tacchettato
622/1
 $\varnothing 12 \times 6 \text{ mm}$



Section Sezione	L 95 mm H 95 mm Art.	L 95 mm H 145 mm Art.	L 170 mm H 160 mm Art.	L 145 mm H 175 mm Art.	L 210 mm H 370 mm Art.	L 175 mm H 380 mm Art.
$\varnothing 12 \times 6 \text{ mm}$	37/3	1300/1	582/2	1300/2	583/1	1300/4

Section Sezione	L 220 mm H 250 mm Art.	L 200 mm H 345 mm Art.	L 230 mm H 380 mm Art.	L 200 mm H 420 mm Art.	L 160 mm H 440 mm Art.	L 205 mm H 445 mm Art.
$\varnothing 12 \times 6 \text{ mm}$	36/1	35/2	36/2	37/2	37/1	35/1







Rings

Cerchi

Arteferro circles, with their simple, discreet shape, are items that can complete any wrought iron composition. Since they can be used as decorations and joints, they even help to support items of great structural complexity. They are available with various types of section: rounded, half rounded, square with hot pressed ends and various types of finishes.

I cerchi Arteferro, con la loro forma semplice e discreta, sono elementi in grado di completare qualsiasi composizione in ferro battuto. Utilizzabili come decoro e congiunzione, aiutano a sostenere i manufatti anche di grande complessità strutturale. Sono disponibili in varie sezioni: tondo, mezzo tondo, quadre con estremità stampate a caldo e lavorazioni di vario tipo.

arteferro

Arteferro
products
can be manufactured
as well as customised.

I prodotti Arteferro
sono realizzabili
anche su misura.







PLAIN RINGS CERCHI LISCI

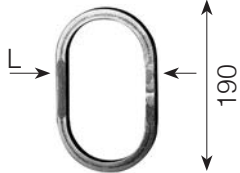
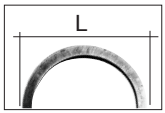

Section Sezione	Ø 10 mm	Ø 12 mm	Ø 14 mm	Ø 16 mm	⌀ 12 x 12 mm	⌀ 14 x 14 mm	⌀ 16 x 16 mm	⌀ 18 x 18 mm	⌀ 20 x 20 mm	⌀ 25 x 25 mm	⌀ 30 x 30 mm
	Art.	Art.	Art.	Art.	Art.	Art.	Art.	Art.	Art.	Art.	Art.
Ø 89 mm	-	-	-	-	491/8/D89	-	-	-	-	-	-
Ø 100 mm	1317/6	1317/9	1803/4	-	491/8	491/16	491/17	-	-	-	-
Ø 105 mm	-	-	-	-	1802/64	1802/65	1802/114	-	-	-	-
Ø 110 mm	-	1317/27	1803/7	-	1802/68	1802/69	1802/70	-	-	-	-
Ø 115 mm	1317/7	1317/10	1803/5	-	1317/1	1802/73	1802/74	-	-	-	-
Ø 120 mm	1317/24	1317/25	-	-	1802/77	1802/78	1802/79	-	-	-	-
Ø 127 mm	-	-	-	-	491/8/D127	-	-	-	-	-	-
Ø 130 mm	1317/8	1317/11	1803/6	-	1317/2	1802/82	1802/83	1802/84	-	-	-
Ø 133 mm	-	-	-	-	491/8/D133	-	-	-	-	-	-
Ø 135 mm	-	-	-	1803/8	-	-	1802/115	-	-	-	-
Ø 140 mm	-	-	-	-	491/8/D140	-	-	-	-	-	-
Ø 160 mm	-	-	-	-	1802/88	1802/89	1802/90	-	1802/92	-	-
Ø 180 mm	-	-	-	-	1802/96	1802/97	1802/98	1802/99	1802/100	1802/101	1802/102
Ø 190 mm	-	-	-	-	-	-	-	-	-	-	-
Ø 200 mm	-	-	-	-	1802/105	1802/106	1802/107	1802/108	1802/109	1802/110	1802/111

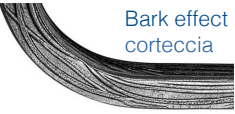
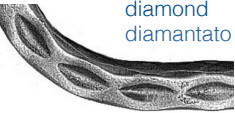

Section Sezione	▧ 12 x 6 mm	▧ 14 x 6 mm	▧ 14 x 8 mm	▧ 16 x 4 mm	▧ 16 x 6 mm	▧ 16 x 8 mm	▧ 20 x 4 mm	▧ 20 x 6 mm	▧ 20 x 8 mm	▧ 25 x 4 mm	▧ 30 x 8 mm	▧ 40 x 8 mm
	Art.	Art.	Art.	Art.	Art.	Art.	Art.	Art.	Art.	Art.	Art.	Art.
Ø 100 mm	157/1	1320/7	1320/10	1320/1	1802/1	1802/2	157/6	1320/4	1802/3	157/11	1802/112	1802/113
Ø 105 mm	1802/4	1802/5	1802/6	1802/7	1802/8	1802/9	1802/10	1802/11	1802/12	-	1802/62	1802/63
Ø 110 mm	1802/13	1802/14	1802/15	1802/16	1802/17	1802/18	1802/19	1802/20	1802/21	-	1802/66	1802/67
Ø 115 mm	157/2	1320/8	1320/11	1320/2	1802/22	1802/23	157/7	1320/5	1802/24	157/12	1802/71	1802/72
Ø 120 mm	1802/25	1802/26	1802/27	1802/28	1802/29	1802/30	1802/31	-	1802/33	-	1802/75	1802/76
Ø 130 mm	157/3	1320/9	1320/12	1320/3	1802/34	1802/35	157/8	1320/6	1802/36	157/13	-	1802/81
Ø 160 mm	157/4	1802/37	1802/38	1802/39	1802/40	1802/41	157/9	1802/42	1802/43	157/14	1802/86	1802/87
Ø 180 mm	1802/44	-	1802/46	1802/47	1802/48	1802/49	1802/50	1802/51	1802/52	-	1802/94	-
Ø 190 mm	157/5	-	-	-	-	-	157/10	-	-	157/15	-	-
Ø 200 mm	1802/53	1802/54	1802/55	1802/56	1802/57	1802/58	1802/59	1802/60	1802/61	-	1802/103	1802/104

Section - Sezione ∅ 12 x 12 mm			
		Art.	Art.
 plain liscio	L 100 mm	491/8	1317/3
	L 115 mm	1317/1	1317/4
	L 130 mm	1317/2	1317/5
 Bark effect corteccia	L 100 mm	1317/18	1317/21
	L 115 mm	1317/19	1317/22
	L 130 mm	1317/20	1317/23
 diamond diamantato	L 100 mm	-	1318/4
	L 115 mm	1318/2	1318/5
	L 130 mm	1318/3	1318/6
 hammered spigolato	L 100 mm	491/9	1318/9
	L 115 mm	1318/7	1318/10
	L 130 mm	1318/8	1318/11
 rigato grooved	L 100 mm	-	1318/15
	L 115 mm	-	-
	L 130 mm	1318/14	1318/17
 four-leaf clover quadrifoglio	L 100 mm	-	-
	L 115 mm	1319/2	-
	L 130 mm	1319/3	1319/6

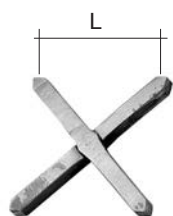

Art. 1321/9
∅ 12 x 12 mm
L 100 x 100 mm
Art. 1321/11
∅ 14 x 14 mm
L 100 x 100 mm



Art. 1321/3
∅ 12 x 12 mm
120 x 125 mm



hammered
spigolato
Art. 1803/1
∅ 12 x 6 mm
∅ 100 mm
Art. 1803/2
∅ 12 x 6 mm
∅ 115 mm
Art. 1803/3
∅ 12 x 6 mm
∅ 130 mm

hammered
tacchettato



plain
liscio
∅ 12 x 6 mm
Art. 1299/5
∅ 100 mm
Art. 1299/6
∅ 130 mm
∅ 14 x 6 mm
Art. 1299/7
∅ 100 mm
Art. 1299/8
∅ 130 mm



Art. 1319/27
∅ 20 x 10 mm
L 100 mm
Art. 1319/30
∅ 30 x 15 mm
L 100 mm

hammered
spigolato



Art. 638/6
∅ 16 x 16 mm
∅ 350 mm



Art. 1317/26
∅ 14 mm
∅ 120 mm



Art. 1320/31
170 x 100 mm



Art. 157/17
∅ 12 x 6 mm
90 x 100 mm



Art. 691/5
∅ 12 mm
∅ 75 mm



Art. 156/A/6
∅ 5 x 5 mm
∅ 63 mm



Art. 156/A/1
∅ 6 x 6 mm
∅ 25 mm

OVAL RINGS - CERCHI OVALI

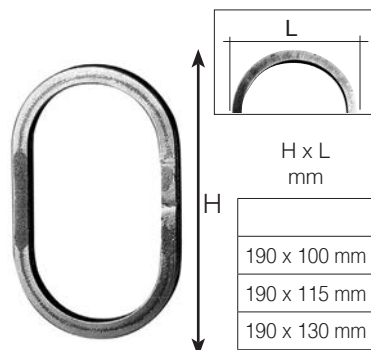

H x L mm	Ø 10 mm	Ø 12 mm	Ø 12 x 12 mm	12 x 6 mm	14 x 6 mm	14 x 8 mm	16 x 4 mm	20 x 4 mm	20 x 6 mm
	Art.	Art.	Art.	Art.	Art.	Art.	Art.	Art.	Art.
190 x 100 mm	1317/12	1317/15	1317/3	1320/22	1320/19	1320/28	1320/13	1320/25	1320/16
190 x 115 mm	1317/13	1317/16	1317/4	1320/23	1320/20	-	1320/14	-	1320/17
190 x 130 mm	1317/14	1317/17	1317/5	1320/24	1320/21	1320/30	1320/15	1320/27	1320/18

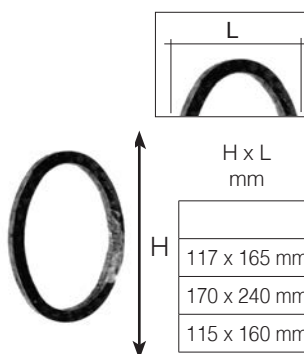

H x L mm	Ø 12 x 12 mm	Ø 14 x 14 mm	12 x 6 mm
	Art.	Art.	Art.
117 x 165 mm	156/1	-	-
170 x 240 mm	-	156/4	-
115 x 160 mm	-	-	157/16



Section Sezione	12 x 6 mm	14 x 6 mm
	Art.	Art.
L 100 mm	491/3	-
L 115 mm	491/4	-
L 130 mm	491/5	--
L 100 mm	491/6	-
L 115 mm	-	1319/8

hammered
tacchettato

diamond
diamantato

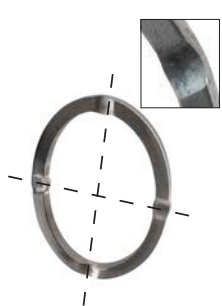

with 4 stamps
con 4 stampe
Art. 156/2
Ø 12 x 12 mm
125 x 175 mm

Art. 156/5
Ø 14 x 14 mm
176 x 249 mm

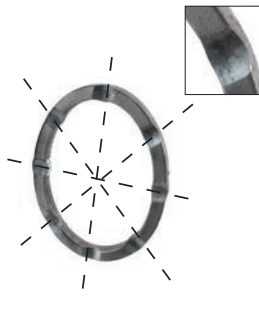

with 8 stamps
con 8 stampe
Art. 156/3
Ø 12 x 12 mm
130 x 170 mm

Art. 156/6
Ø 14 x 14 mm
192 x 273 mm

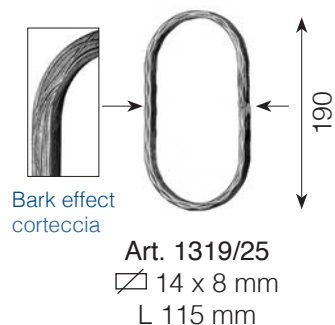

Bark effect
corteccia
Art. 1319/25
14 x 8 mm
L 115 mm



Art. 6143/1
Ø 20 x 20 mm
Ø 650 mm



Art. 6143/2
Ø 20 x 20 mm
Ø 420 mm



Art. 6143/3
Ø 20 x 20 mm
Ø 200 mm



Art. 6143/4
Ø 16 x 16 mm
100 x 350 mm



Art. 6112/5
20 x 15 mm
300 x 100 mm







Spheres



Sfere



Arteferro produces spheres with different finishes: plain, faceted, forged and hollow. The spheres are often combined with other wrought iron items, making it possible to create high quality decorative articles: they can be used as terminals for pickets or posts, as spacers, or as compositional elements for creating different organic shapes, like bunches of grapes.

Arteferro produce sfere con diverse finiture: lisce, diamantate, spicchiate e vuote. Le sfere vengono spesso abbinare ad altri elementi in ferro battuto, permettendo di realizzare manufatti decorativi di elevato pregio: possono essere utilizzate come terminali per paletti o caposaldi, come distanziali o come elementi compositivi per la realizzazione di diverse forme organiche come i grappoli d'uva.

arteferro

				
Diameter Diámetro	Hot stamped plain spheres Sfere lisce stampate a caldo	Handforged spheres Sfere forgiate a mano	Hollow spheres Sfere vuote	
	Art.	Art.	Art.	
Ø 16 mm	117/1/L 	117/1	-	
Ø 20 mm	116/F/1	117/2	1394/1 Blind hole-Foro cieco Ø 6 mm Thickn.-Spess. 2 mm	
Ø 22 mm	-	-	1394/2 Blind hole-Foro cieco Ø 6 mm Thickn.-Spess. 2 mm	
Ø 25 mm	116/F/2	117/3	1394/3 Blind hole-Foro cieco Ø 6 mm Thickn.-Spess. 2 mm	
Ø 30 mm	116/F/3	117/4	1394/4 Blind hole-Foro cieco Ø 6 mm Thickn.-Spess. 2 mm	
Ø 35 mm	123/1	117/5	1394/5 Blind hole-Foro cieco Ø 7 mm Thickn.-Spess. 2 mm	
Ø 40 mm	116/F/4	117/6	1394/6 Blind hole-Foro cieco Ø 7 mm Thickn.-Spess. 2 mm	
Ø 45 mm	-	-	1394/7 Blind hole-Foro cieco Ø 8 mm Thickn.-Spess. 2 mm	
Ø 50 mm	116/F/5	117/7	1394/8 Blind hole-Foro cieco Ø 9 mm Thickn.-Spess. 2 mm	
Ø 55 mm	-	-	1394/9 Blind hole-Foro cieco Ø 9 mm Thickn.-Spess. 2 mm	
Ø 60 mm	116/F/6	117/8	1394/10 Blind hole-Foro cieco Ø 10 mm Thickn.-Spess. 2 mm	
Ø 70 mm	116/F/7	117/9	1394/11 Blind hole-Foro cieco Ø 10 mm Thickn.-Spess. 2 mm	
Ø 80 mm	116/F/8		1394/12 Blind hole-Foro cieco Ø 11 mm Thickn.-Spess. 2 mm	
Ø 90 mm	116/F/9		1394/13 Without hole-Senza foro Thickn.-Spess. 2 mm	
Ø 100 mm	116/F/10		1394/14 Without hole-Senza foro Thickn.-Spess. 2 mm	
Ø 110 mm	-		1394/15 Without hole-Senza foro Thickn.-Spess. 2,5 mm	
Ø 120 mm	116/F/17		1394/16 Without hole-Senza foro Thickn.-Spess. 2 mm	
Ø 130 mm	-		1394/17 Without hole-Senza foro Thickn.-Spess. 2 mm	
Ø 140 mm	-		1394/18 Without hole-Senza foro Thickn.-Spess. 2 mm	
Ø 150 mm	116/F/19		1394/19 Without hole-Senza foro Thickn.-Spess. 2 mm	
Ø 200 mm	-		1394/20 Without hole-Senza foro Thickn.-Spess. 1,5 mm	

		
Diameter Diámetro	Half hollow spheres hole 12.5 mm 2 mm thick Mezze sfere vuote foro 12,5 mm spess. 2 mm	Half full spheres Mezze sfere piene
	Art.	Art.
Ø 30 mm	1395/9	-
Ø 40 mm	1395/8	-
Ø 50 mm	-	819/12 H = 20 mm

					
Diameter Diámetro	Pressed plain spheres Sfere lisce schiacciate	Diameter Diámetro	Hot forged oval spheres Sfere forgiate ovali	Diameter Diámetro	Hot forged faceted spheres Sfere diamantate
Ø 70 x H 40 mm	202/4	Ø 28 x H 38 mm	1396/5	Ø 20 mm	116/F/11
Ø 90 x H 57 mm	202/2	Ø 40 x H 60 mm	1396/3	Ø 25 mm	116/F/12
Ø 110 x H 67 mm	202/1	Ø 55 x H 75 mm	1396/2	Ø 30 mm	-
		Ø 65 x H 95 mm	1396/1	Ø 50 mm	116/F/16





Bushes

Borchie

Arteferro bushes are compositional elements that are often used for the construction of wrought iron fences, railings, gates and balconies. Available in a range of versions, stamped, lathed, forged or tubular; with or without through holes, they can be fitted to pickets or posts and serve as a decorative element.

Le borchie Arteferro sono elementi compositivi spesso utilizzati per la realizzazione di recinzioni, inferriate, cancelli e balconate in ferro battuto. Disponibili in varie versioni, stampate, tornite, forgiate o in tubolare; con o senza foro passante, possono essere assemblate ai paletti o ai piantoni e fungono da elemento decorativo.

arteferro



HAND FORGED BUSHES - BORCHIE FORGIATE A MANO



Art. 1389/3
53 x 200 mm
Ø 12 mm



Art. 1389/4
30 x 150 mm
Ø 12 x 12 mm



Art. 1389/5
30 x 150 mm
Ø 12 x 12 mm



Art. 738/8
42 x 120 mm
Ø 12 mm



Art. 738/9
40 x 120 mm
Ø 12 mm



Art. 737/7
H 40 mm
L 42 mm



Art. 737/8
H 85 mm
L 42 mm



H 40 mm
Ø 45 mm

Art. 737/1
hole - foro
for/per Ø 16 mm

Art. 737/2
hole - foro
for/per Ø 18 mm

Art. 737/3
hole - foro
for/per Ø 20 mm



H 68 mm
Ø 45 mm

Art. 737/4
hole - foro
for/per Ø 16 mm

Art. 737/5
hole - foro
for/per Ø 18 mm

Art. 737/6
hole - foro
for/per Ø 20 mm





TUBE BUSHING
Ø 30 mm thickness 1,5 mm

BORCHIE IN TUBO
Ø 30 mm spessore 1,5 mm



Art. 1243/2
H 140 mm
Ø 30 mm
hole for
foro per
Ø 12 mm



Art. 1243/3
H 60 mm
Ø 30 mm
hole for
foro per
Ø 12 mm



Art. 1243/4
H 150 mm
Ø 30 mm
hole for
foro per
Ø 12 mm



Art. 1243/5
H 330 mm
Ø 30 mm
hole for
foro per
Ø 12 mm



Art. 1243/7
H 100 mm
Ø 30 mm
hole for
foro per
Ø 12 mm



Art. 1243/8
H 70 mm
Ø 30 mm
hole for
foro per
Ø 12 mm



Art. 1243/9
H 155 mm
Ø 30 mm
hole for
foro per
Ø 12 mm



Art. 1243/10
H 145 mm
Ø 30 mm
hole for
foro per
Ø 12 mm

TUBE BUSHING - BORCHIE IN TUBO

Ø 30 mm thickn.-spess. 1,5 mm - Ø 40 mm thickn.-spess. 2 mm - Ø 50 mm thickn.-spess. 2 mm



Art. 154/1
H 120 mm
Ø 30 mm

hole for - foro per dia.
Ø 12 mm

Art. 154/A/3

H 180 mm
Ø 40 mm

hole for - foro per dia.
Ø 16 mm



Art. 154/2
H 150 mm
Ø 30 mm

hole for - foro per dia.
Ø 12 mm



Art. 154/3
H 105 mm
Ø 30 mm

hole for - foro per dia.
Ø 12 mm



Art. 154/5
H 100 mm
Ø 30 mm

hole for - foro per dia.
Ø 12 mm



Art. 1244/4
H 150 mm
Ø 30 mm



Art. 1244/20
H 150 mm
Ø 30 mm



Art. 154/A/1
H 105 mm
Ø 40 mm

hole for - foro per dia.
Ø 14 mm



Art. 154/A/2
H 75 mm
Ø 40 mm

hole for - foro per dia.
Ø 14 mm



Art. 154/A/4
H 120 mm
Ø 40 mm

hole for - foro per dia.
Ø 16 mm



Art. 155/1
H 85 mm
Ø 30 mm

hole for - foro per dia.
Ø 12 mm

Art. 154/A/5
H 105 mm
Ø 40 mm

hole for - foro per dia.
Ø 16 mm

Art. 154/A/6
H 75 mm
Ø 40 mm

hole for - foro per dia.
Ø 16 mm

Art. 154/B/1
H 105 mm
Ø 40 mm

hole for - foro per dia.
Ø 12 mm

Art. 154/B/2
H 75 mm
Ø 40 mm

hole for - foro per dia.
Ø 12 mm



Art. 742/4
H 50 mm
25 x 25 mm

thickn.-spess.
1,5 mm

hole for - foro per dia.
Ø 12 mm



Art. 742/2
H 75 mm
34 x 34 mm

thickn.-spess.
2 mm

hole for - foro per dia.
Ø 14 mm



Art. 155/8

Tube Ø 30 x 1,5 mm
H 100 mm
Ø 30 mm
Hole Ø 13 mm

Art. 155/2
H 65 mm
Ø 30 mm

hole for - foro per dia.
Ø 12 mm

Art. 155/3
H 50 mm
Ø 30 mm

hole for - foro per dia.
Ø 12 mm

Art. 154/B/3
H 120 mm
Ø 40 mm

hole for - foro per dia.
Ø 14 mm

Art. 154/B/5
H 95 mm
Ø 40 mm

hole for - foro per dia.
Ø 14 mm

Art. 1793/7
H 83 mm
Ø 50 mm

hole for - foro per dia.
Ø 22 mm



Art. 155/4
H 20 mm
Ø 30 mm

hole for - foro per dia.
Ø 12 mm



Art. 155/7
H 30 mm
Ø 30 mm

hole for - foro per dia.
Ø 12 mm



Art. 1244/15
H 30 mm
Ø 30 mm



Art. 154/B/3
H 120 mm
Ø 40 mm

hole for - foro per dia.
Ø 14 mm



Art. 154/B/5
H 95 mm
Ø 40 mm

hole for - foro per dia.
Ø 14 mm



Art. 1793/7
H 83 mm
Ø 50 mm

hole for - foro per dia.
Ø 22 mm

Art. 154/A/7

H 25 mm
Ø 40 mm

hole for - foro per dia.
Ø 16 mm

Art. 154/B/4

H 120 mm
Ø 40 mm







hole for - foro per dia.
Ø 16 mm

Art. 154/B/6

H 95 mm
Ø 40 mm

hole for - foro per dia.
Ø 16 mm

STAMPED AND CAST BUSHES- BORCHIE STAMPATE E DI FUSIONE

	hole - foro 	 Stamped steel Ferro stampato	 Cast steel Ferro fuso	Hole - Foro 	 Stamped steel with insert Ferro stampato con inserto	 Cast steel Ferro fuso
Dimensions Dimensioni	Section Sezione	Art.	Art.	Section Sezione	Art.	Art.
H 63 mm Ø 38 mm	Without hole-Senza foro	128/3	-	-	-	-
	12 mm	128/6	747/18	12 x 12 mm	126/F/1	747/12
	14 mm	128/7	747/19	14 x 14 mm	-	-
	16 mm	128/8	747/20	16 x 16 mm	-	-
H 68 mm Ø 45 mm	Without hole-Senza foro	128/4	-	-	-	-
	12 mm	-	-	12 x 12 mm	126/F/2	1392/1
	14 mm	-	-	14 x 14 mm	126/F/3	747/13
	16 mm	128/9	-	16 x 16 mm	-	-
	18 mm	128/10	-	18 x 18 mm	-	-
	20 mm	128/11	-	20 x 20 mm	-	-
H 78 mm Ø 50 mm	Without hole-Senza foro	128/5	-	-	-	-
	12 mm	-	-	12 x 12 mm	-	-
	14 mm	-	-	14 x 14 mm	126/F/4	1392/2
	16 mm	128/12	-	16 x 16 mm	126/F/5	747/14
	18 mm	128/13	-	18 x 18 mm	-	-
	20 mm	128/14	-	20 x 20 mm	-	-
	22 mm	-	-	22 x 22 mm	-	-



STAMPED AND CAST BUSHES - BORCHIE STAMPATE E DI FUSIONE

Dimensions Dimensioni	Section Sezione	Art.	Art.	Section Sezione	Art.	Art.
H 35 mm Ø 38 mm	Without hole-Senza foro	128/16	-	Without hole-Senza foro	-	-
	12 mm	128/17	747/21	12 x 12 mm	126/F/6	747/15
	14 mm	128/18	747/22	14 x 14 mm	-	-
	16 mm	128/19	747/23	16 x 16 mm	-	-
H 44 mm Ø 45 mm	Without hole-Senza foro	128/20	-	-	-	-
	12 mm	-	-	12 x 12 mm	126/F/7	-
	14 mm	-	-	14 x 14 mm	126/F/8	747/16
	16 mm	128/21	-	16 x 16 mm	-	-
	18 mm	128/22	-	18 x 18 mm	-	-
	20 mm	128/23	-	20 x 20 mm	-	-
H 46 mm Ø 50 mm	Without hole-Senza foro	128/24	-	-	-	-
	12 mm	-	-	12 x 12 mm	-	-
	14 mm	-	-	14 x 14 mm	126/F/9	1392/4
	16 mm	128/25	-	16 x 16 mm	126/F/10	747/17
	18 mm	128/26	-	18 x 18 mm	-	-
	20 mm	128/27	-	20 x 20 mm	-	-
	22 mm	128/28	-	22 x 22 mm	-	-



Ø 40 mm - H 23 mm

hole - foro



Hole for section Foro per sezione	Art.
12 x 12 mm	128/38
14 x 14 mm	128/2
16 x 16 mm	128/39



Ø 40 mm - H 24 mm

hole - foro



Hole for section Foro per sezione	Art.
12 x 12 mm	1393/25
14 x 14 mm	1393/26

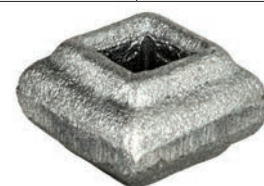

L 33 mm - H 22 mm

hole - foro



Hole for section Foro per sezione	Art.
12 x 12 mm	1393/19

L 55 mm - H 35 mm

hole - foro



Hole for diameter Foro per diametro	Art.
Ø 12 mm	128/36
Ø 14 mm	128/1
Ø 16 mm	128/37

hole - foro



Hole for diameter Foro per diametro	Art.
Ø 12 mm	1393/27
Ø 14 mm	1393/28

Hole for section Foro per sezione	Art.
20 x 20 mm	1393/18

STAMPED BUSHES - BORCHIE STAMPATE



Hot stamped
Stampata a caldo
Ø 35 mm - H 63 mm



Hole for dia. - Foro per dia.	Art.
Without hole - Senza Foro	126/F/11
12 mm	739/4
14 mm	739/5
16 mm	739/6



Hot stamped
Stampata a caldo
Ø 35 mm - H 40 mm



Hole for dia. - Foro per dia.	Art.
12 mm	1854/1
14 mm	1854/2



Hot stamped with insert
Stampata a caldo con inserto
Ø 35 mm - H 40 mm



hole for sec. - foro per sez.	Art.
12 x 12 mm	1854/3



Hot stamped
Stampata a caldo
Ø 60 mm - H 65 mm



Hole for dia. - Foro per dia.	Art.
16 mm	1393/20
20 mm	1393/21
24 mm	1393/22



Cast steel
Ferro fuso
Ø 60 mm - H 65 mm

hole for sec. - foro per sez.	Art.
14 x 14 mm	1393/23
16 x 16 mm	-



Hot stamped
Stampata a caldo
Art. 128/B/2
foro/hole Ø 20 mm
H 95 mm - Ø 50 mm



Hot stamped with insert
Stampata a caldo con inserto
Ø 45 mm - H 54 mm



hole for sec. - foro per sez.	Art.
Without hole - Senza Foro	126/F/12
12 x 12 mm	126/F/13
14 x 14 mm	126/F/14



Cast steel
Ferro fuso
Ø 45 mm - H 54 mm



hole for sec. - foro per sez.	Art.
Without hole - Senza Foro	1392/5
12 x 12 mm	1392/6
14 x 14 mm	1392/7



Hot stamped
Stampata a caldo
Ø 45 mm - H 54 mm



Hole for dia. - Foro per dia.	Art.
12 mm	739/1
14 mm	739/2
16 mm	739/3

STAMPED BUSHES - BORCHIE STAMPATE



H 120 mm
Ø 32 mm



H 63 mm
Ø 32 mm

Hole for dia. - Foro per dia.	Art.	Art.
Without hole - Senza foro	-	128/C/15
Ø 12 mm	128/C/9	-
Ø 14 mm	128/C/10	128/C/13
Ø 16 mm	128/C/11	128/C/14



H 78 mm
Ø 69 mm



H 50 mm
Ø 69 mm

Hole for dia. - Foro per dia.	Art.	Art.
Without hole - Senza foro	-	741/6
Ø 25 mm	128/C/5	-
Ø 30 mm	128/C/6	741/3
Ø 35 mm	-	741/4
Ø 40 mm	128/C/8	741/5



Cast steel
Ferro fuso
H 78 mm
Ø 69 mm



hole for sec. - foro per sez.	Art.
25 x 25 mm	741/7
30 x 30 mm	741/8

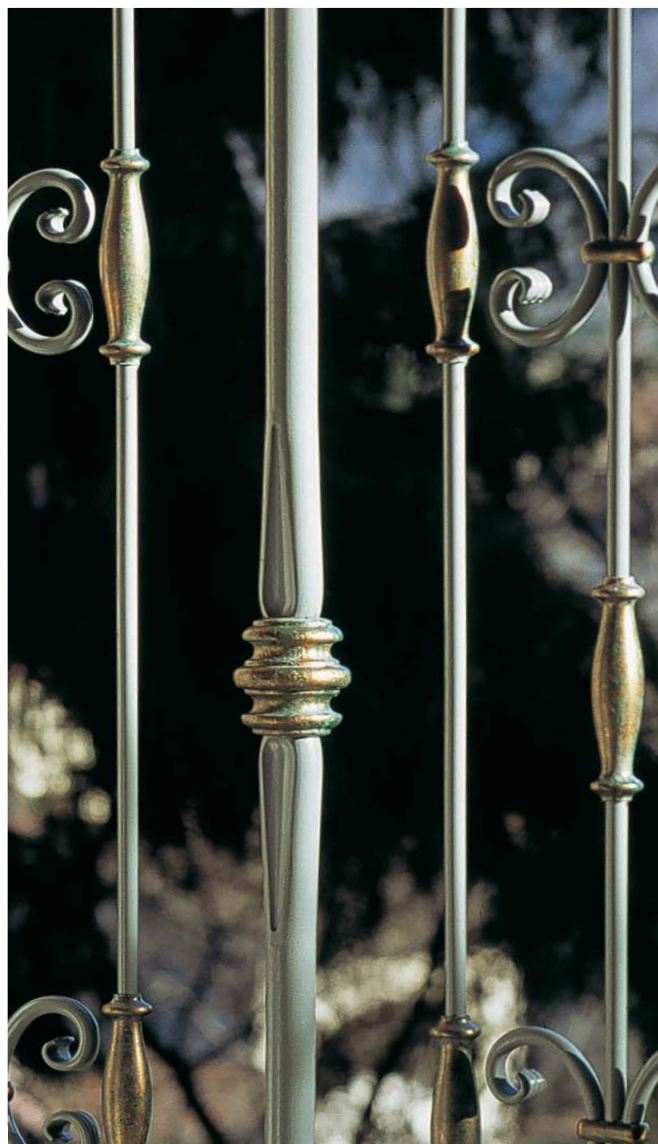

Arteferro products are available in raw metal as well as sandblasted or galvanized on request.

I prodotti Arteferro sono disponibili in metallo grezzo e, su richiesta, anche sabbiati o zincati a freddo.



Dim.	Art.	Art.	Art.	Art.
H 55 mm Ø 35 mm	-	1393/15 hole for dia. - foro per dia. Ø 14 mm	1393/16 hole for sec. - foro per sez. ⊠ 12 x 12 mm	-
H 75 mm Ø 50 mm	1393/10 hole for dia. - foro per dia. Ø 18 mm	1393/11 hole for dia. - foro per dia. Ø 20 mm	1393/12 hole for sec. - foro per sez. ⊠ 14 x 14 mm	1393/13 hole for sec. - foro per sez. ⊠ 16 x 16 mm



Stamped steel
with insert
Ferro stampato
con inserto



Cast steel
Ferro fuso



Cast steel
Ferro fuso



Cast steel
Ferro fuso



Dim.	Hole for sec. - Foro per sez.	Art.	Art.	Art.	Art.
H 45 mm L 40 mm	12 x 12 mm	-	-	-	1391/21
	14 x 14 mm	-	-	-	1391/22
	16 x 16 mm	-	-	-	1391/23
H 65 mm L 40 mm	12 x 12 mm	-	-	1391/4	-
	14 x 14 mm	-	-	1391/5	-
	16 x 16 mm	-	-	1391/6	-
H 67 mm L 40 mm	Without hole-Senza foro	-	1391/18	-	-
	12 x 12 mm	127/7	1391/7	-	-
	14 x 14 mm	127/8	-	-	-
	16 x 16 mm	-	1391/9	-	-
H 88 mm L 45 mm	Without hole-Senza foro	127/3	1391/17	-	-
	14 x 14 mm	-	1391/10	-	-
	16 x 16 mm	-	1391/11	-	-

Arteferro products are available in raw metal as well as sandblasted or galvanized on request.

I prodotti Arteferro sono disponibili in metallo grezzo e, su richiesta, anche sabbatiati o zincati a freddo.

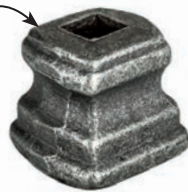

Stamped steel
with insert
Ferro stampato
con inserto



Cast steel
Ferro fuso

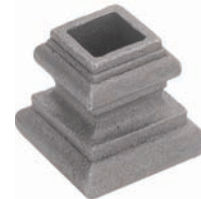

Cast steel
Ferro fuso



Dimens.	Hole for sec. - Foro per sez.	Art.	Art.	Art.
H 38 mm L 40 mm	Without hole - Senza Foro	-	1391/20	-
	12 x 12 mm	-	1391/12	-
	14 x 14 mm	127/13	-	-
	16 x 16 mm	127/14	1391/14	-
H 40 mm L 40 mm	12 x 12 mm	-	-	1391/1
	14 x 14 mm	-	-	1391/2
	16 x 16 mm	-	-	1391/3
H 45 mm L 45 mm	Without hole - Senza Foro	-	1391/19	-
	14 x 14 mm	127/15	-	-
	16 x 16 mm	-	1391/16	-



Art. 535/6
Ø 55 mm
Total black
Marmo nero



Art. 535/5
Ø 55 mm
White marble
Marmo bianco



Art. 535/4
Ø 55 mm
Red granite
Granito rosso



Art. 531/2
Ø 50 mm
Glass/vetro
Blue/Blu



Art. 531/3
Ø 50 mm
Glass/vetro
Green/Verde



Art. 745/3
Ø 52 mm
Wood/Legno

Hand painted ceramic spheres
Sfere in ceramica dipinte a mano



Art. 533/5
Ø 55 mm



Art. 533/6
Ø 55 mm



Art. 533/7
Ø 55 mm



Art. 533/8
Ø 55 mm

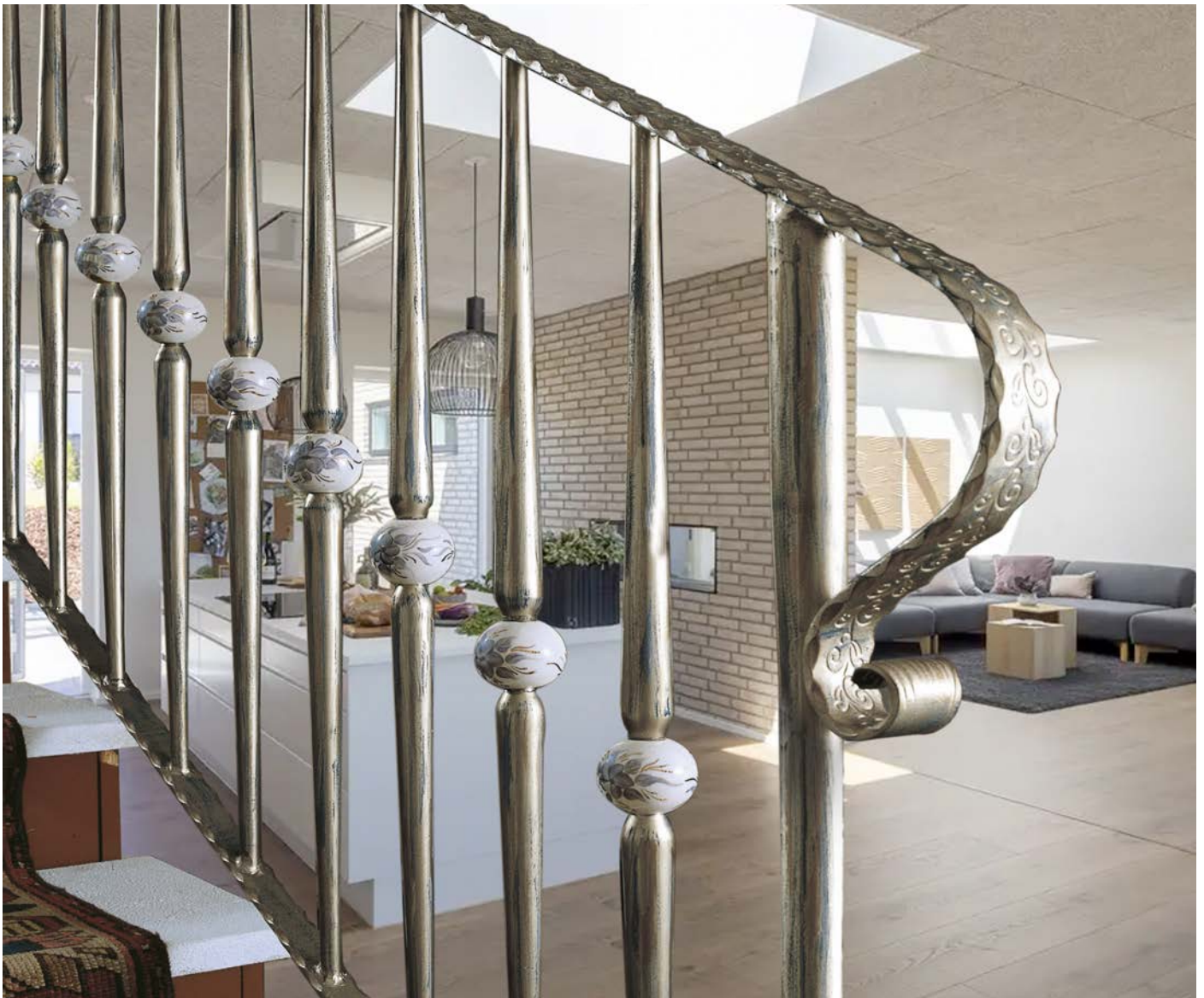

GHISA MALLEABILE SALDABILE, MA NON ZINCABILE
MALLEABLE WELDABLE CAST IRON, GALVANIZING IS NOT RECOMMENDED

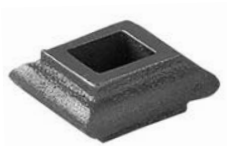

Art. 1390/1
H 17 mm
L 38 mm
hole for/foro per sezione
∅ 17 x 17 mm



Art. 1390/2
H 45 mm
L 48 mm
hole for/foro per sezione
∅ 16 x 16 mm



Art. 1390/4
H 40 mm
L 60 x 40 mm
hole for/foro per sezione
□ 28 x 8 mm



Art. 1390/5
H 65 mm
L 40 mm
hole for/foro per sezione
∅ 16 x 16 mm



Art. 1491/3
H 28 mm
L 40 mm
hole for/foro per sezione
∅ 12 x 12 mm

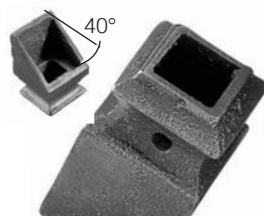

Art. 1491/1
H 50 mm
L 30 mm
hole for/foro per sezione
∅ 12 x 12 mm



Art. 746/6
H 40 mm
L 38 mm
hole for/foro per sezione
∅ 14 x 14 mm

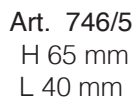

Art. 746/5
H 65 mm
L 40 mm
hole for/foro per sezione
∅ 14 x 14 mm

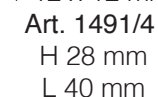

Art. 1491/4
H 28 mm
L 40 mm
hole for/foro per sezione
∅ 14 x 14 mm

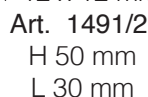

Art. 1491/2
H 50 mm
L 30 mm
hole for/foro per sezione
∅ 14 x 14 mm

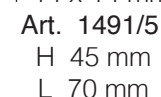

Art. 1491/5
H 45 mm
L 70 mm
hole for/foro per sezione
∅ 27 x 27 mm



Art. 746/1
H 45 mm
L 40 mm
hole for/foro per sezione
∅ 12 x 12 mm



Art. 746/2
H 50 mm
L 55 mm
hole for/foro per sezione
∅ 20 x 20 mm



Art. 746/3
H 48 mm
L 48 mm
hole for/foro per sezione
∅ 16 x 16 mm



Art. 746/4
H 30 mm
L 48 mm
hole for/foro per sezione
∅ 16 x 16 mm

GHISA MALLEABILE SALDABILE, MA NON ZINCABILE
MALLEABLE WELDABLE CAST IRON, GALVANIZING IS NOT RECOMMENDED



Art. 747/1
H 260 mm
Ø 50 mm

hole for/foro per sezione
□ 16 x 16 mm



Art. 747/2
H 110 mm
L 35 mm

hole for/foro per sezione
□ 16 x 16 mm



Art. 747/3
H 20 mm
L 35 mm

hole for/foro per sezione
□ 16 x 16 mm



Art. 747/4
H 20 mm
Ø 33 mm

hole for/foro per sezione
Ø 16 mm



Art. 747/5
H 185 mm
Ø 40 mm

hole for/foro per sezione
□ 16 x 16 mm



Art. 747/6
H 130 mm
Ø 40 mm

hole for/foro per sezione
□ 16 x 16 mm



Art. 747/7
H 75 mm
Ø 40 mm

hole for/foro per sezione
□ 16 x 16 mm



Art. 747/8
H 115 mm
Ø 40 mm

hole for/foro per sezione
□ 14 x 14 mm
H 115 mm
Ø 40 mm

Art. 747/9

hole for/foro per sezione
□ 12 x 12 mm



Art. 747/10
H 70 mm
Ø 40 mm

hole for/foro per sezione
□ 14 x 14 mm

Art. 747/11

H 70 mm
Ø 40 mm

hole for/foro per sezione
□ 12 x 12 mm





Baskets

Pigne

Arteferro baskets are central decorations, and are installed by welding the ends to the pickets they are inserted into. Their ornamental function confers an artistic dynamism to any structural element they are applied to, creating an elegant and sinuous wrought iron artefact.

Le pigne Arteferro sono decori centrali e vengono installate saldandone le estremità al paletto nel quale vengono inserite. La loro funzione ornamentale conferisce dinamicità artistica all'elemento strutturale al quale vien applicata, creando un manufatto in ferro battuto elegante e sinuoso.

arteferro





Art.	Ø	H	A	B
159/1	35 mm	90 mm	8 x 8 mm	4 x 4 mm
159/2	55 mm	110 mm	10 x 10 mm	5 x 5 mm
159/3 BEST PRICE	60 mm	125 mm	12 x 12 mm	6 x 6 mm
159/4	60 mm	125 mm	14 x 14 mm	7 x 7 mm
159/5	65 mm	145 mm	16 x 16 mm	8 x 8 mm
159/6	80 mm	165 mm	20 x 20 mm	10 x 10 mm
159/7	95 mm	180 mm	24 x 24 mm	12 x 12 mm
159/9	100 mm	220 mm	30 x 30 mm	15 x 15 mm
159/10	130 mm	280 mm	40 x 40 mm	20 x 20 mm

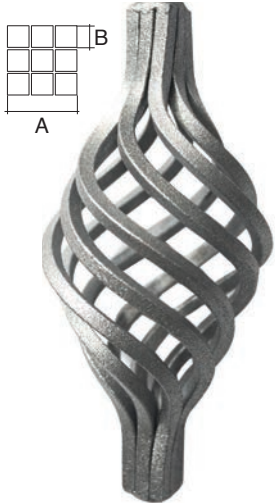

Art.	Ø	H	A	B
158/B/1	55 mm	130 mm	12 x 12 mm	4 x 4 mm
158/B/2	60 mm	145 mm	15 x 15 mm	5 x 5 mm
158/B/3	80 mm	170 mm	21 x 21 mm	7 x 7 mm
158/B/4	95 mm	220 mm	24 x 24 mm	8 x 8 mm
158/B/5	95 mm	270 mm	30 x 30 mm	10 x 10 mm

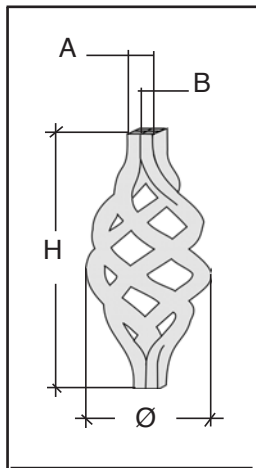

The baskets were included in our product range in 1981 in response to requests from the emerging German market

Le pigne sono state inserite nella nostra produzione nel 1981 per rispondere alla richiesta dell'emergente mercato tedesco



BASKETS WITH ROD - PIGNE CON TONDINO

Art.	Ø	H	A	B
1163/1	35 mm	90 mm	8 x 8 mm	Ø 4 mm
1163/3	55 mm	125 mm	12 x 12 mm	Ø 6 mm
1163/4	60 mm	125 mm	14 x 14 mm	Ø 7 mm
1163/5	70 mm	145 mm	16 x 16 mm	Ø 8 mm
1163/6	75 mm	165 mm	20 x 20 mm	Ø 10 mm
1163/7	100 mm	180 mm	24 x 24 mm	Ø 12 mm



Art. 158/B/7
Ø 70 mm
B = 6 x 6 mm



Art. 158/B/6
Ø 70 mm
B = 8 x 8 mm



Art. 1163/9
Ø 70 mm
B = Ø 6 mm



Art. 158/B/8
Ø 40 mm
H 125 mm
A = 12 x 12 mm
B = 6 x 6 mm

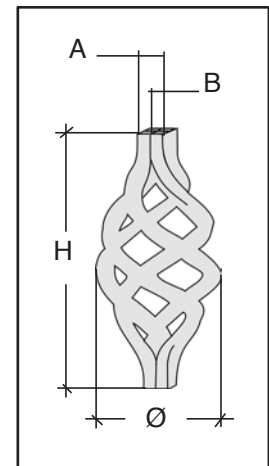

Art. 1164/3
Ø 80 mm
H 180 mm
A = Ø 20 mm
B = 10 x 10 mm
Hole - Foro Ø 10 mm



Art. 1164/2
Ø 70 mm
B = 6 x 6 mm
Hole - Foro Ø 6 mm



Art. 1164/1
Ø 90 mm
B = 6 x 6 mm
Hole - Foro Ø 6 mm



Flowers and Rosettes

Fiori e Rosette

The flowers and ornaments made by Arteferro are mainly characterised by floral motifs, threadlike ribs and metallic decorations inspired by nature. They find an application in various contexts and can embellish and enhance the structure they seem to be growing from.

I fiori e gli ornamenti realizzati da Arteferro sono principalmente caratterizzati da motivi floreali, nervature filiformi e decorazioni metalliche si ispirano alla natura. Trovano applicazione in diversi contesti e sono in grado di arricchire e valorizzare il manufatto dal quale sembreranno sbocciare.

arteferro

Cast steel
Ferro fuso



Art. 40/B/12
Ø 48 mm
∠ 2 mm



Art. 1393/6
Ø 55 mm
Spess. 8 mm



Art. 138/1
10 mm - Ø 60 mm
∠ 2 mm



Art. 138/2
Ø 60 mm
∠ 2 mm



Art. 138/15
Ø 60 mm
∠ 2 mm



Art. 664/1
Ø 60 mm
Foro Ø 8 mm
∠ 3 mm



Art. 116/A/4
Ø 65 mm
∠ 3 mm



Art. 697/4
Ø 65 mm
∠ 3 mm



Art. 1393/5
Ø 90 mm
Spess. 8 mm



Art. 660/11
Ø 90 mm
∠ 4 mm



Art. 660/12
Ø 90 mm
∠ 4 mm



Art. 697/1
Ø 90 mm
∠ 3 mm

Ferro fuso



Art. 664/2
Ø 90 mm
Foro Ø 16 mm
∠ 3 mm



Art. 116/A/3
Ø 95 mm
∠ 3 mm



Art. 116/A/5
Ø 95 mm
∠ 3 mm



Art. 697/3
Ø 95 mm
∠ 3 mm



Art. 94/B/5
Ø 105 mm
∠ 4 mm



Art. 711/5
17 mm - Ø 107 mm
∠ 0,5 mm

116/A/3+116/A/4 + 41/5



Art. 94/B/6
Ø 115 mm
∠ 4 mm



Art. 660/10
Ø 115 mm
∠ 4 mm



Art. 1393/4
Ø 125 mm
Spess. 8 mm



Art. 695/4
Ø 85 mm
∠ 4 mm



Art. 138/4
10 mm - Ø 90 mm
∠ 2 mm



Art. 665/1
Ø 130 mm
∠ 4 mm



Art. 665/2
Ø 140 mm
∠ 4 mm



Art. 711/6
28 mm - Ø 150 mm
∠ 0,3 mm



Art. 126/3
Ø 80 mm
Spess./Thickn. 4 mm



Art. 701/1
Ø 38 mm
Spess./Thick.
0,4 mm



Art. 697/2
Ø 60 mm
Spess./Thickn. 3 mm



Art. 664/10
Ø 100 mm



Art. 664/11
Ø 150 mm



Art. 664/5
Ferro fuso/Cast steel
Ø 90 mm
foro/hole Ø 8 mm
Spess./Thick. 3 mm



Art. GD239/5
Ø 90 mm
Foro/Hole Ø 12 mm
Spess./Thick. 3 mm



Art. 656/B/1
Ø 100 mm
Art. 656/B/2
Ø 60 mm



Art. 656/B/3
Ø 100 mm
Art. 656/B/4
Ø 60 mm



Art. 656/B/6
Ø 60 mm



Art. 665/4
Ø 90 mm
Spess./Thick. 2 mm



Art. 665/5
Ø 80 mm
Spess./Thick. 2 mm



Art. 665/6
Ø 80 mm
Spess./Thick. 2 mm

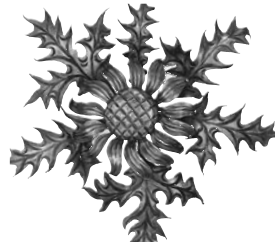

Art. 696/2
Ø 440 mm



Art. 137/9
65 x 110 mm
Spess./Thick.
0,5 mm



Art. 137/10
175 x 125 mm
Spess./Thick.
0,5 mm



Art. 137/7
130 x 65 mm
Spess./Thick.
0,5 mm



Art. 137/8
90 x 50 mm
Spess./Thick.
0,5 mm



Art. 1406/3
40 mm - Ø 140 mm

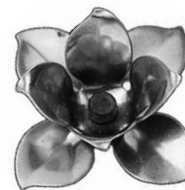

Art. 705/7
16 mm - Ø 45 mm
Filetto/Thread M3
Spess./Thickn. 0,3 mm



Art. 138/14
Ø 120 mm
Spess./Thick.
4 mm



Art. 701/3
25 mm - Ø 90 mm
Spess./Thickn. 0,3 mm



Art. 711/4
45 mm - Ø 120 mm
Spess./Thickn. 0,3 mm



Art. 138/3
17 mm - Ø 88 mm
Spess./Thick.
2 mm



Art. 138/6
10 mm - Ø 55 mm
Spess./Thick.
0,3 mm



Art. 138/13
195 x 190 mm
Spess./Thick.
0,5 mm



Art. 138/12
105 x 95 mm
Spess./Thick.
0,5 mm



Art. 138/11
75 x 70 mm
Spess./Thick.
0,5 mm



Art. 704/9
H 90 x L 34 mm
Spess./Thickn. 0,3 mm



Art. 136/10
160 x 70 mm
Spess./Thick.
3 mm



Art. 136/11
160 x 70 mm
Spess./Thick.
3 mm



Art. 136/5
30 mm - Ø 65 mm
Spess./Thick.
0,3 mm

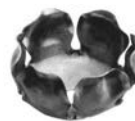

Art. 136/6
33 mm - Ø 55 mm
Spess./Thick.
0,3 mm



Art. 136/7
40 mm - Ø 38 mm
Spess./Thick.
0,3 mm



Art. 702/2
H 65 x L 52 mm
Spess./Thick.
0,5 mm



Art. 138/7
H 30 x L 85 mm
Spess./Thickn. 0,3 mm



Art. 138/16
H 30 x L 85 mm
Spess./Thickn. 0,3 mm



Art. 140/B/1
H 175 x L 289 mm
Spess./Thickn. 5 mm

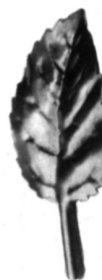

Art. 138/8
H 60 x L 28 mm
Spess./Thick.
0,3 mm



Art. 136/3
70 x 60 mm
BEST PRICE
∅ 2,5 mm



Art. 136/4
70 x 60 mm
BEST PRICE
∅ 2,5 mm



Art. 136/1
110 x 40 mm
∅ 3 mm



Art. 136/2
110 x 40 mm
∅ 3 mm

Art. 138/10
H 85 x L 45 mm
Spess./Thick.
0,3 mm

Art. 136/13
90 x 30 mm
∅ 3 mm

Art. 136/12
90 x 30 mm
∅ 3 mm



Art. 705/3
45 mm - Ø 55 mm
Thread - Filetto M3
Ø 0,3 mm



Art. 705/5
36 mm - Ø 40 mm
Thread - Filetto M3
Ø 0,3 mm



Art. 700/1
45 mm - Ø 60 mm
Ø 1 mm



Art. 700/5
H 45 mm - Ø 30 mm
Ø 1 mm



Art. 140/I/3
68 mm - Ø 60 mm
Ø 4 mm



Art. 750/1
Ø 14 mm
H 125 mm



Art. 691/6
80 x 100 mm
Ø 12 mm
Ø 5 mm



Art. 691/7
80 x 100 mm
Ø 12 mm
Ø 5 mm



Art. 140/I/2
H 110 x L 50 mm
Ø 4 mm



Art. 1328/3
Stem-Gambo
Ø 6 mm
H 200 x L 45 mm



Art. 140/C/3
H 355 x L 280 mm
Spess./Thickn. 5 mm



Art. 140/D/1
H 270 x L 190 mm
Spess./Thickn. 5 mm



Art. 140/D/2
H 155 x L 90 mm
Spess./Thickn. 5 mm



Art. 140/H/3
125 x 90 mm
Spess./Thick.
5 mm



Art. 140/E/3
H 265 x L 160 mm
Spess./Thickn. 5 mm



Art. 140/E/1
H 265 x L 70 mm
Spess./Thickn. 5 mm



Art. 140/E/2
H 265 x L 70 mm
Spess./Thickn. 5 mm



Art. 604/11
H 45 x L 32 mm
Spess./Thick.
2,5 mm



Art. 604/12
H 80 x L 32 mm
Spess./Thick.
2,5 mm



Art. 666/8
H 360 x L 110 mm
Spess./Thickn. 4 mm



Art. 707/5
H 140 x L 120 mm
Spess./Thickn. 0,3 mm



Art. 709/17
H 175 x L 41 mm
Spess./Thickn. 0,3 mm



Art. 710/11
85 mm - Ø 100 mm
Spess./Thickn. 0,3 mm



Art. 1328/1
Gambo/Stam
Ø 8 mm
H 400 - Ø 120 mm



Art. 1329/6
Ø 8 mm
500 x 130 mm



Art. 1328/2
Gambo/Stam
Ø 6 mm
H 300 - Ø 80 mm



Art. 700/4
Ø 5 mm
H 300 mm



Art. 700/2
Ø 6 mm
H 320 mm



Art. 1329/1
Ø 8 mm
H 450 x L 140 mm



Art. 690/3
Ø 12 mm
H 112 x L 70 mm
Spess./Thickn. 5 mm



Art. 690/4
Ø 12 mm
H 112 x L 70 mm
Spess./Thickn. 5 mm



Art. 691/2
Ø 12 mm
100 x 160 mm
Spess./Thickn. 5 mm



Art. 692/10
H 230 x L 110 mm
Spess./Thickn. 4 mm



Art. 692/1
H 270 x L 85 mm
Spess./Thickn. 4 mm



Art. 694/9
H 100 x L 20 mm
Spess./Thickn. 4 mm



Art. 694/10
H 80 x L 20 mm
Spess./Thickn. 4 mm



Art. 694/11
H 190 x L 95 mm
Spess./Thickn. 6 mm



Art. 694/13
H 210 x L 120 mm
Spess./Thickn. 6 mm



Art. 666/2
55 x 90 mm
Ø 4 mm



Art. 692/8
100 x 330 mm
Ø 4 mm



Art. 666/5
45 x 190 mm
Ø 4 mm



Art. 717/5/S1
H 285 mm
Ø 2 mm

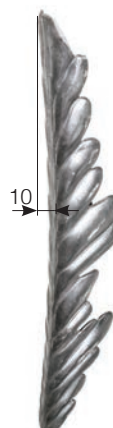

Art. 717/5/S3
L 25 x H 290 mm
Ø 2 mm



Art. 717/5/S4
L 25 x H 285 mm
Ø 2 mm



Art. 604/5
Ø 16 mm
H 370 mm



Art. 604/10
Ø 12 mm
H 370 mm



Art. 1328/7
H 150 x L 45 mm
Spess./Thickn. 4 mm



Art. 1328/8
H 190 x L 100 mm
Spess./Thickn. 4 mm



Art. 1328/9
H 180 x L 170 mm
Spess./Thickn. 4 mm



Art. 717/5
H 285 x L 50 mm
Spess./Thick.
1,5 mm



Art. 720/3
Ø 6 mm
H 500 x L 270 mm



Art. 82/4
Ø 8 mm
L 90 mm



Art. 83/10
8 x 8 mm
H 60 mm



Art. 83/11
8 x 8 mm
H 120 mm



Art. 94/B/14
180 x 150 mm
Spess./Thick.
4 mm



Art. 94/B/15
150 x 160 mm
Spess./Thick.
4 mm



Art. 94/B/16
150 x 160 mm
Spess./Thick.
4 mm



Art. 83/13
8 x 8 mm
H 120 mm



Art. 83/2
8 x 8 mm
H 120 mm



Art. 83/6
8 x 8 mm
H 120 mm



Art. 94/B/9
120 x 85 mm
Spess./Thick.
4 mm



Art. 94/B/1
H 140 x L 70 mm
Spess./Thick. 4 mm



Art. 94/B/10
120 x 85 mm
Spess./Thick.
4 mm



Art. NEW0059
Base 20 mm
□ 2,5 mm
H 118 x L 65 mm



Art. 83/7
8 x 8 mm
H 60 mm



Art. 83/8
8 x 8 mm
H 60 mm



Art. 85/6
12 x 12 mm
L 225 mm



Art. 656/B/7
50 x 125 mm
sinistra-left



Art. 656/B/8
50 x 125 mm
destra-right



Art. 675/10
H 110 x L 85 mm
Spess./Thickn. 3 mm



Art. 675/11
H 110 x L 85 mm
Spess./Thickn. 3 mm



Art. 675/12
H 110 x L 80 mm
Spess./Thickn. 3 mm



Art. 675/13
H 110 x L 80 mm
Spess./Thickn. 3 mm



Art. 675/5
H 135 x L 85 mm
Spess./Thickn. 4 mm



Art. 675/1
320 x 75 mm
Spess./Thick. 4 mm



Art. 675/2
240 x 65 mm
Spess./Thick. 4 mm



Art. 675/4
150 x 45 mm
Spess./Thick. 4 mm



Art. 666/4
H 190 x L 45 mm
Spess./Thickn. 4 mm



Art. 676/2
base Ø 8 mm
H 20 mm
Ø 50 mm



Art. 673/3
Ø 6 mm
H 150 mm



Art. 675/7
H 240 x L 70 mm
Spess./Thickn. 8 mm



Art. 675/6
H 240 x L 70 mm
Spess./Thickn. 8 mm



Art. 675/8
H 85 x L 60 mm
Spess./Thickn. 3 mm



Art. 675/9
H 85 x L 60 mm
Spess./Thickn. 3 mm



Art. 675/14
H 85 x L 60 mm
Spess./Thickn. 3 mm



Art. 675/15
H 85 x L 60 mm
Spess./Thickn. 3 mm



Stamped
Stampata

Art. 751/1
95 x 185 mm



stem - gambo Ø 12 mm

Art. 94/B/11
180 x 130 mm
□ 4 mm



Art. 94/B/12
180 x 130 mm
□ 4 mm



stem - gambo Ø 12 mm

Art. 94/B/7
90 x 65 mm
□ 4 mm



Art. 94/B/8
90 x 65 mm
□ 4 mm

GEMINI - GEMELLI



Art. 891/3
grezzo/unpainted
Ø 260 mm
12 x 6 mm
drawing/fregio
3 mm

ARIES - ARIETE



Art. 892/2
grezzo/unpainted
Ø 260 mm
12 x 6 mm
drawing/fregio
3 mm



Art. 689/1
Forged - Forgiato
Ø 12 mm
H 210 x L 120 mm
Spess./Thick.
5 mm



Art. 689/3
Forged - Forgiato
Ø 12 mm
H 240 x L 120 mm
Spess./Thick.
5 mm



Art. 690/2
Forged - Forgiato
H 160 x L 80 mm
Ø 12 mm
Spess./Thickn. 5 mm



Art. 690/1
Forged - Forgiato
H 160 x L 80 mm
Ø 12 mm
Spess./Thickn. 5 mm



Forged - Forgiato
Art. 140/H/1
130 x 270 mm



Forged - Forgiato
Art. 140/H/2
90 x 170 mm

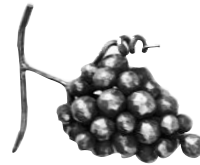

Forged - Forgiato
Art. 673/1
270 x 130 mm



Forged - Forgiato
Art. 673/2
170 x 90 mm



Art. 692/2
Forged - Forgiato
H 80 x L 80 mm



Art. 692/3
Forged - Forgiato
H 95 x L 60 mm
Spess./Thickn. 4 mm



Art. 692/4
Forged - Forgiato
H 170 x L 95 mm
Spess./Thickn. 5 mm



Art. 692/5
Forged - Forgiato
H 150 x L 95 mm
Spess./Thickn. 5 mm



Art. 692/7
Forged - Forgiato
H 120 x L 95 mm
Spess./Thickn. 5 mm



Art. 692/9
Forged - Forgiato
180 x 50 mm
Spess./Thick.
4 mm



Art. 695/1
Forged - Forgiato
H 80 x L 80 mm
Spess./Thick.
4 mm



Art. 695/2
H 85 x L 85 mm
Forged - Forgiato
Spess./Thick.
4 mm



Art. 695/5
H 60 x L 60 mm
Forged - Forgiato
Spess./Thick.
4 mm



Art. 676/3
H 20 mm - Ø 70 mm
Forged - Forgiato
Base Ø 8 mm

CAST STEEL - FERRO FUSO



Art. 662/5
∅ 16 x 6 mm
150 x 250 mm



Art. 662/6
∅ 16 x 6 mm
150 x 250 mm



Art. 662/1
∅ 16 x 8 mm
105 x 220 mm



Art. 662/2
∅ 16 x 8 mm
105 x 220 mm



Art. 661/1
∅ 16 x 8 mm
140 x 155 mm



Art. 661/2
∅ 16 x 8 mm
140 x 155 mm



Art. 663/5
∅ 12 mm
115 x 180 mm



Art. 663/6
∅ 12 mm
115 x 180 mm



Art. 663/1
∅ 16 x 6 mm
110 x 140 mm



Art. 663/2
∅ 16 x 6 mm
110 x 140 mm



Art. 662/3
∅ 12 mm
H 130 x L 65 mm



Art. 662/4
∅ 12 mm
H 130 x L 65 mm



Art. 663/3
∅ 12 mm
H 90 x L 70 mm



Art. 663/4
∅ 12 mm
H 90 x L 70 mm



Art. 663/7
∅ 12 mm
H 190 x L 160 mm



Art. 663/8
∅ 12 mm
H 190 x L 160 mm



Art. 664/3
H 40 - ∅ 40 mm
Spess./Thickn. 3 mm



Art. 664/4
∅ 12 mm
H 90 x L 90 mm
Spess./Thick. 3 mm



Art. 660/4
H 210 x L 130 mm
Spess./Thickn. 6 mm



Art. 660/7
H 215 x L 145 mm
Spess./Thickn. 6 mm



Art. 660/8
H 215 x L 145 mm
Spess./Thickn. 6 mm



Art. 689/8
∅ 12 mm
160 x 100 mm
Spess./Thick.
5 mm



Art. 689/9
∅ 12 mm
200 x 150 mm
Spess./Thick.
5 mm



Art. 664/6
H 200 x L 60 mm



Art. 661/3
∅ 8 mm
110 x 155 mm



Art. 661/4
∅ 8 mm
75 x 125 mm
Art. 661/5
∅ 6 mm
80 x 125 mm



Art. 664/8
130 x 250 mm
∅ 3 mm



Art. 664/7
50 x 285 mm
∅ 3 mm



Art. 664/9
∅ 12 mm
H 285 x L 80 mm

CAST STEEL - FERRO FUSO



Art. 664/1
Ø 60 mm
hole/foro Ø 8 mm
Thick./Spessore
∅ 3 mm



Art. 664/2
Ø 90 mm
hole/foro Ø 16 mm
Thick./Spessore
∅ 3 mm



Art. 664/3
Ø 40 mm
H 40 mm
Thick./Spessore
∅ 3 mm



Art. 664/4
Ø 12 mm
90 x 90 mm
Thick./Spessore
∅ 3 mm



Art. 664/5
Ø 90 mm
hole/foro Ø 8 mm
Thick./Spessore
∅ 3 mm



Art. 664/6
60 x 200 mm



Art. 664/8
130 x 250 mm
Thick./Spessore
∅ 3 mm



Art. 664/7
50 x 285 mm
Thick./Spessore
∅ 3 mm



Art. 664/9
Ø 12 mm
80 x 285 mm



GHISA MALLEABILE SALDABILE, MA NON ZINCABILE
MALLEABLE WELDABLE CAST IRON, GALVANIZING IS NOT RECOMMENDED



Art. 756/12
Ø 135 mm
Thread hole/Filetto M5
Spess./Thick.
12 mm

Art. 756/13
Ø 115 mm
Thread hole/Filetto M5
Spess./Thick.
12 mm

Art. 756/14
Ø 75 mm
Thread hole/Filetto M5
Spess./Thick.
9 mm

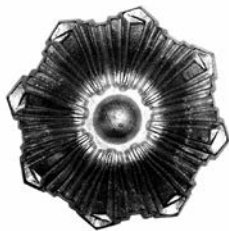

Art. 757/5
25 mm - Ø 105 mm
Thread hole/Filetto M5
Spess./Thick. 10,5 mm



Art. 756/8
H 210 x L 330 mm
2 Thread hole/Filetto M5
Spess./Thickn. 28 mm



Art. 756/16
H 100 x L 220 mm
Thread hole/Filetto M5
Spess./Thickn. 15 mm



Art. 1393/9
Ø 55 mm
Spess./Thick. 8 mm



Art. 756/6
245 x 285 mm
4 Thread hole/Filetto M5
Spess./ Thick. 7 mm



Art. 756/4
Ø 100 mm
Thread hole/Filetto M6



Art. 756/2
Ø 80 mm
Thread hole/Filetto M5





Decorations in steel sheet

Decorati in lamiera

Arteferro scrolls and snap-ons have been designed to embellish even the simplest wrought iron composition. Like the other Arteferro decorative elements, they can be used in many different projects, from gates to the railings, as well as on stairways and balconies. Even a fence or a balustrade with vertical posts made of plain iron can be embellished at a later time by these useful decorative items.

I ricci e gli snap-ons Arteferro sono stati ideati per impreziosire anche la più semplice composizione in ferro battuto. Come gli altri elementi decorativi Arteferro, trovano applicazione in molteplici realizzazioni, dalla cancellate alle inferriate, così come nelle scale e nelle balconate. Anche una recinzione o un parapetto in paletti verticali di ferro liscio può essere arricchita in un secondo momento con l'utilizzo di questi utili elementi decorativi.

arteferro



Art. 852/8
spess. 6 mm
H 70 mm - L 1218 mm

Art. 852/9
thickn.-spess. 2 mm
H 45 mm - L 1212 mm

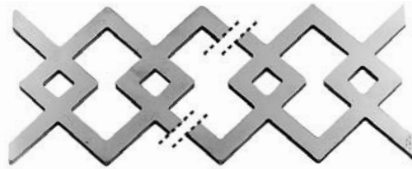

Art. 852/10
thickn.-spess. 8 mm
H 124 mm - L 1206 mm

Art. 852/11
thickn.-spess. 2 mm
H 45 mm - L 1215 mm

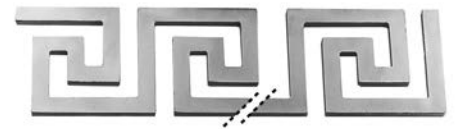

Art. 852/6
thickn.-spess. 6 mm
H 84 mm - L 1152 mm

Art. 852/7
thickn.-spess. 2 mm
H 45 mm - L 1213 mm



Art. 852/13
thickn.-spess. 2 mm
H 45 mm - L 1212 mm



Art. 852/14
thickn.-spess. 6 mm
H 84 mm - L 1160 mm

Art. 852/15
thickn.-spess. 2 mm
H 45 mm - L 1242 mm

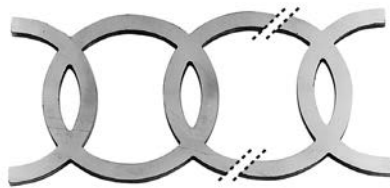

Art. 852/4
thickn.-spess. 8 mm
H 124 mm - L 1129 mm



Art. 852/5
thickn.-spess. 6 mm
H 84 mm - L 1140 mm



Art. 1813/1
14 x 6 mm
H 155 mm
L 755 mm

Art. 1813/3
14 x 6 mm
H 155 mm
L 580 mm

Art. 1813/4
14 x 6 mm
H 155 mm
L 415 mm



Art. 1813/5
14 x 6 mm
H 190 mm
L 580 mm

Art. 1813/6
14 x 6 mm
H 190 mm
L 960 mm





thickn.-spess. 3 mm - H 55 mm - L 960 mm
Art. 1409/7
plain - liscio



thickn.-spess. 3 mm - H 55 mm - L 993 mm
Art. 1409/8
plain - liscio

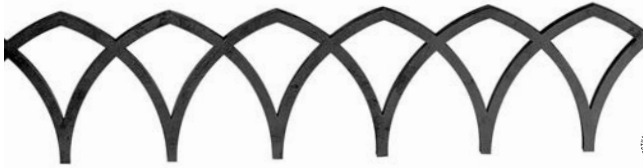

Art. 1411/1
12 x 6 mm - H 165 mm - L 1230 mm



Art. 1411/2
12 x 6 mm - H 165 mm - L 1160 mm - incl. 30°



Art. 1411/3
thickn.-spess. 2 mm - H 45 mm - L 1230 mm
Art. 1411/4
thickn.-spess. 6 mm - H 84 mm - L 1250 mm



Art. 1411/5
thickn.-spess. 6 mm - H 84 mm - L 1225 mm
incl. 30°



12 x 12 mm
Art. 1321/7
100 x 125 mm
Art. 1321/2
125 x 125 mm
14 x 14 mm
Art. 1321/3
100 x 100 mm
Art. 1321/4
125 x 125 mm

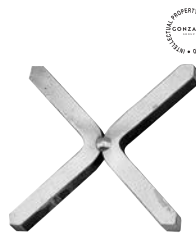

12 x 12 mm
Art. 1321/5
100 x 100 mm
14 x 14 mm
Art. 1321/7
100 x 100 mm
Art. 1321/8
125 x 125 mm



12 x 12 mm
Art. 1321/9
100 x 100 mm
14 x 14 mm
Art. 1321/11
100 x 100 mm



Art. 1326/1
Ø 6 mm
L 2000 mm



Galvanized and painted
Zincate e verniciateRaw
GrezzeRaw
GrezzeRaw
GrezzeRaw
Grezze

	Stamped Coniato	Stamped Coniato	Plain Liscio	Plain Liscio	Plain Liscio	Plain Liscio
	H 120 mm	H 200 ÷ 250 mm	H 200 ÷ 250 mm	130 x 170 x 6 mm	55 x 80 x 3 mm	40 x 80 mm
	Art.	Art.	Art.	Art.	Art.	Art.
1	171/1	1414/1	1414/12	-	-	*851/1
2	171/2	1414/2	1414/13	-	-	*851/2
3	171/3	1414/3	1414/14	-	-	*851/3
4	171/4	1414/4	1414/15	-	-	*851/4
5	171/5	1414/5	1414/16	-	-	*851/5
6	171/6	1414/6	1414/17	-	-	*851/6
7	171/7	1414/7	1414/18	-	-	*851/7
8	171/8	1414/8	1414/19	-	-	*851/8
9	171/9	1414/9	1414/20	-	-	*851/9
0	171/10	1414/10	1414/21	-	-	*851/10
A	171/11	1412/1	1413/1	850/1	*850/27	-
B	171/12	1412/2	1413/2	850/2	*850/28	-
C	171/13	1412/3	1413/3	850/3	*850/29	-
D	171/14	1412/4	1413/4	850/4	*850/30	-
E	-	1412/5	1413/5	850/5	*850/31	-
F	-	1412/6	1413/6	850/6	*850/32	-
G	-	1412/7	1413/7	850/7	*850/33	-
H	-	1412/8	1413/8	850/8	*850/34	-
I	-	1412/9	1413/9	850/9	*850/35	-
J	-	1412/10	1413/10	850/24	*850/50	-
K	-	1412/11	1413/11	850/10	*850/36	-
L	-	1412/12	1413/12	850/11	*850/37	-
M	-	1412/13	1413/13	850/12	*850/38	-
N	-	1412/14	1413/14	850/13	*850/39	-
O	-	1412/15	1413/15	850/14	*850/40	-
P	-	1412/16	1413/16	850/15	*850/41	-
Q	-	1412/17	1413/17	850/16	*850/42	-
R	-	1412/18	1413/18	850/17	*850/43	-
S	-	1412/19	1413/19	850/18	*850/44	-
T	-	1412/20	1413/20	850/19	*850/45	-
U	-	1412/21	1413/21	850/20	*850/46	-
V	-	1412/22	1413/22	850/21	*850/47	-
W	-	1412/23	1413/23	850/22	*850/48	-
X	-	1412/24	1413/24	850/25	*850/51	-
Y	-	-	1413/25	850/26	*850/52	-
Z	-	1412/26	1413/26	850/23	*850/49	-

* Letter and number can be matched with the frame of items from no. 851/12 to 851/18

* Lettera e numero abbinabili alla cornice dall'art. 851/12 all'art.851/18

FRAMES FOR NUMBERS AND LETTERS - CORNICI PORTA NUMERI E LETTERE



* Art. 851/14
169 x 302 mm
up to 5 numbers
fino a 5 numeri

* Art. 851/15
169 x 392 mm
up to 7 numbers
fino a 7 numer



Art. 851/11
80 x 40 mm



* Art. 851/17
145 x 273 mm
up to 5 numbers
fino a 5 numeri

* Art. 851/18
151 x 353 mm
up to 7 numbers
fino a 7 numeri

example - esempio



Art. 852/1
∅ 12 mm
H 290 mm
L 230 mm



Art. 852/2
∅ 12 mm
H 240 mm
L 180 mm



Art. 140/I/1
H 250 x L 195 mm
Spessore/Thickness
6 mm



Art. 1412/27
stamped/coniato
H 250 x L 250 mm
Art. 1413/27
plain - liscio
H 250 x L 250 mm



Art. 1414/22
plain - liscio
H315 x L 245 mm



Art. 1412/28
stamped/coniato
H 220 x L 170 mm



Art. 199/11
∅ 3 mm
45 x 25 mm



Art. 199/2
∅ 3 mm
120 x 120 mm



Art. 199/3
∅ 3 mm
60 x 160 mm



Art. 199/13
∅ 3 mm
40 x 105 mm



Art. 199/14
∅ 3 mm
40 x 105 mm



Art. 199/16
∅ 3 mm
75 x 230 mm



Art. 199/17
∅ 3 mm
75 x 230 mm



Plates and Accessories

Piastre ed Accessori

Arteferro plates are decorative elements that can either be positioned at the base or alongside posts, and can be manufactured with a rounded or square shape, depending on the client's aesthetic requirements. Arteferro accessories are mainly complementary elements and have no structural function, such as: handles, knobs, hinges and locks.

Le piastre Arteferro sono elementi decorativi poste o alla base o a lato dei montanti e possono essere realizzate di forma tonda o quadrata a seconda delle esigenze estetiche della committenza. Gli accessori Arteferro invece sono principalmente elementi di complemento e non hanno funzione strutturale, quali: maniglie, pomolini, cardini e serrature.

arteferro

17 Plates and Accessories Piastrre ed Accessori



17.A Anchor plates	Piastrre di ancoraggiopag.358	17.F Locks	Serrature pag.368
17.B Rivets	Ribattini pag.362	17.G Hinges	Cardini pag.369
17.C Chains	Catene pag.363	17.H Paints and varnishes	Patine e Vernici pag.370
17.D Door handles	Manigliepag.364	17.I Weathervanes	Cassette postali pag.371
17.E Locks covers	Copriserratura pag.367	17.L Wheels for gates	Ruote per cancelli pag.372

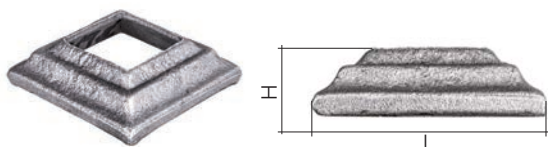

L/H	Hole - Foro	Art.
L 40 x 40 mm H 17 mm	without hole - senza foro	-
	for - per \varnothing 12 x 12 mm	819/8
	for - per \varnothing 14 x 14 mm	819/7
	for - per \varnothing 16 x 16 mm	819/6
L 50 x 50 mm H 19 mm	without hole - senza foro	-
	for - per \varnothing 16 x 16 mm	819/5
	for - per \varnothing 18 x 18 mm	819/4
	for - per \varnothing 20 x 20 mm	819/3
L 60 x 60 mm H 19 mm	without hole - senza foro	819/9
	for - per \varnothing 25 x 25 mm	819/2
	for - per \varnothing 30 x 30 mm	819/1
L 80 x 80 mm H 22 mm	without hole - senza foro	819/17
	for - per \varnothing 25 x 25 mm	819/18
	for - per \varnothing 30 x 30 mm	819/15
	for - per \varnothing 40 x 40 mm	819/16



Ø/H	Hole - Foro	Art.
Ø 30 mm H 17 mm	without hole - senza foro	-
	per Ø 12 mm	1408/21
Ø 40 mm H 18,5 mm	without hole - senza foro	1408/17
	for - per Ø 12 mm	1408/5
	for - per Ø 14 mm	1408/19
Ø 50 mm H 18 mm	for - per Ø 16 mm	1408/20
	without hole - senza foro	1408/16
	for - per Ø 16 mm	1408/13
Ø 60 mm H 18 mm	for - per Ø 18 mm	-
	for - per Ø 20 mm	1408/11
	without hole - senza foro	1408/15
Ø 80 mm H 19 mm	for - per Ø 25 mm	1408/7
	for - per Ø 30 mm	1408/6
	without hole - senza foro	1408/14
Ø 80 mm H 19 mm	for - per Ø 30 mm	1408/10
	for - per Ø 35 mm	1408/9
	for - per Ø 40 mm	1408/8

ROUNDED BASES BASI BOMBATE



Art. 1860/1
Ø 580 mm
H 45 mm
∇ 6 mm



Art. 1860/6
Ø 414 mm
H 44 mm
∇ 4 mm

Art. 1860/2
Ø 680 mm
H 50 mm
∇ 8 mm

Art. 1860/3
Ø 780 mm
H 55 mm
∇ 8 mm

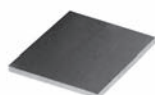

Art. 6036/9
∅ 240 x 240 x 8 mm

BORDERED FLAT BASES BASI PIANE BORDATE



Art.	Ø	H	Thickness Spessore
1861/5	260 mm	28 mm	6 mm
1861/8	370 mm	38 mm	5 mm



Art. 6100/1
metal sheet - lamiera
1570 x 290 x 2 mm

LENS BASES BASI A LENTE



Art.	Ø	H	Thickness Spessore
1861/11	140 mm	13 mm	3 mm
1861/17	295 mm	40 mm	6 mm
1861/20	480 mm	40 mm	6 mm

BORDERED SQUARE BASES BASI QUADRATE BORDATE



Art.	Side Lato	H	Thickness Spessore
1861/22	200 mm	19 mm	6mm



Art. 654/5
Ø 60 mm
⊘ 6 mm



Art. 1393/7
Ø 68 mm
hole - foro
Ø 12,5 mm
⊘ 10 mm



Art. 1857/13
Ø 82 mm
⊘ 4 mm



Art. 1857/14
Ø 82 mm
hole - foro
Ø 8,5 mm
⊘ 4 mm



Art. 1857/15
Ø 82 mm
hole - foro
Ø 15 mm ⊘ 4 mm
H 10 mm



Art. 660/11
Ø 90 mm
⊘ 4 mm



Art. 660/12
Ø 90 mm
⊘ 4 mm



Art. 660/10
Ø 115 mm
⊘ 4 mm



Art. 94/A/3
100 x 100 mm
Spess./Thickn. 8 mm

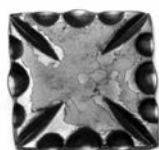

Art. 94/A/4
80 x 80 mm
⊘ 8 mm



Art. 94/A/5
80 x 80 mm
⊘ 8 mm

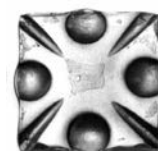

Art. 94/A/6
80 x 80 mm
⊘ 8 mm

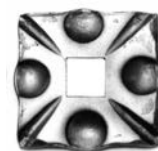

Art. 94/A/10
80 x 80 mm
Spess./Thickn. 8 mm
hole for- foro per
⊘ 25 x 25 mm



Art. 802/5
70 x 70 mm
⊘ 6 mm



Art. 116/A/1
70 x 70 mm
Hole - Foro
⊘ 13 x 13 mm
⊘ 5 mm



Art. 116/A/2
75 x 75 mm
hole - foro
⊘ 13 x 13 mm
⊘ 5 mm



Art. 116/A/6
100 x 100 mm
without hole
senza foro
⊘ 10 mm



Art. 116/A/7
100 x 100 mm
hole - foro
⊘ 30 x 30 mm
⊘ 10 mm



Art. 802/4
100 x 100 mm
⊘ 10 mm



Art. 1857/5
100 x 100 mm
⊘ 8 mm



Art. 1857/7
100 x 100 mm
⊘ 8 mm



Art. 181/6
120 x 120 mm
⊘ 8 mm



Art. 1857/4
⊘ 8 mm



Art. 1408/1
80 x 80 mm
hole - foro
⊘ 26 x 26 mm
H 18 mm

Art. 1408/2
55 x 55 mm
hole - foro
⊘ 15 x 15 mm
H 12 mm



Art. 1470/8
H 300 mm
L 75 mm
⊘ 3 mm
Art. 841/7
H 520 mm
L 75 mm
⊘ 3 mm



Art. NEW0049
⊘ 6 mm
H 280 mm
L 130 mm
Art. NEW0050
⊘ 6 mm
H 220 mm
L 100 mm



Art. 701/10
H 280 mm
L 65 mm



Art. 137/12
H 260 mm
L 145 mm
⊘ 1 mm

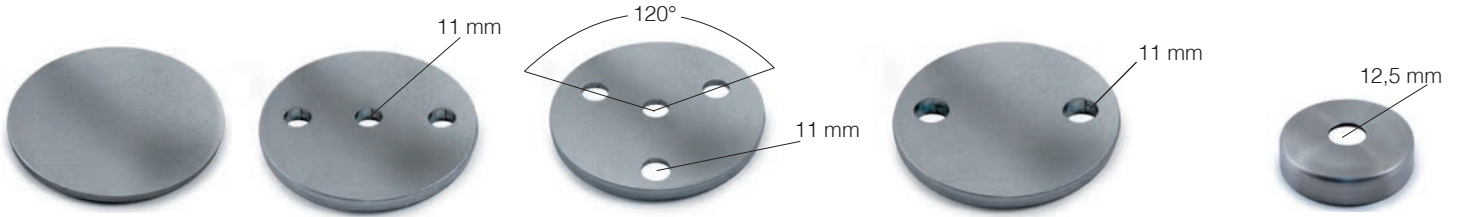

- Art. F060
Ø 33 x 4 mm
- Art. F061
Ø 42 x 4 mm
- Art. F062
Ø 48 x 4 mm
- Art. F063
Ø 60 x 4 mm
- Art. F0631
Ø 70 x 6 mm
- Art. F064
Ø 80 x 4 mm
- Art. F065
Ø 100 x 4 mm
- Art. F066
Ø 100 x 6 mm
- Art. F069
Ø 120 x 6 mm

- Art. F06910
Ø 70 x 6 mm
- Art. F06911
Ø 80 x 6 mm
- Art. F06912
Ø 100 x 8 mm
- Art. F06913
Ø 120 x 8 mm

- Art. F06920
Ø 70 x 6 mm
- Art. F06921
Ø 80 x 6 mm
- Art. F06922
Ø 100 x 8 mm
- Art. F06923
Ø 120 x 8 mm

- Art. F0681
Ø 80 x 6 mm
- Art. F0682
Ø 100 x 6 mm

- Art. F0181
Ø 62 mm
H 15 mm

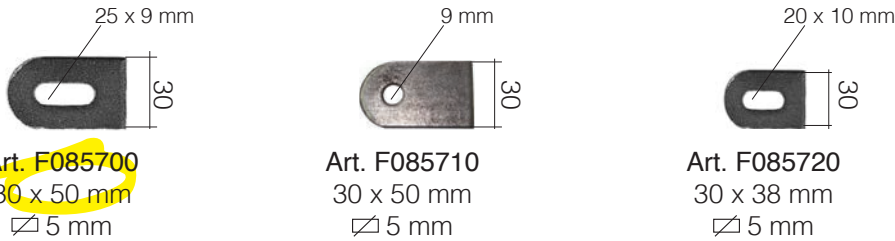

- Art. F085700
30 x 50 mm
∟ 5 mm

- Art. F085710
30 x 50 mm
∟ 5 mm

- Art. F085720
30 x 38 mm
∟ 5 mm



- Art. F083500
50 x 100 mm
∟ 8 mm

- Art. F083510
60 x 120 mm
∟ 8 mm

- Art. F083520
80 x 120 mm
∟ 8 mm

- Art. F083610
60 x 120 mm
∟ 8 mm

- Art. F083620
120 x 80 mm
∟ 8 mm

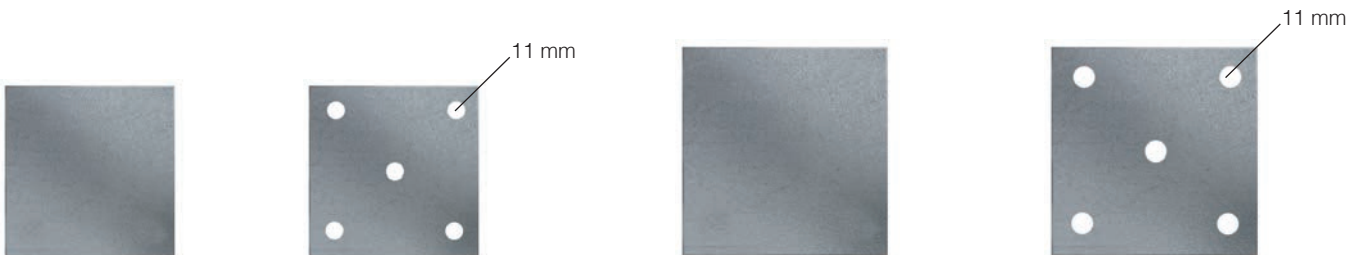

- Art. F085500
100 x 100 mm
∟ 6 mm

- Art. F085600
100 x 100 mm
∟ 6 mm

- Art. F085510
120 x 120 mm
∟ 8 mm

- Art. F085610
120 x 120 mm
∟ 8 mm



Art. F0222

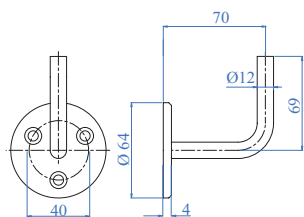

Art. F02231

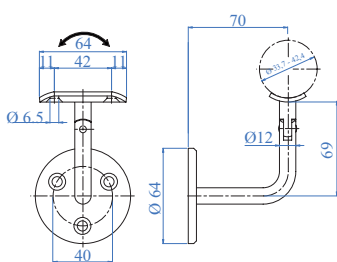

Art. F0223

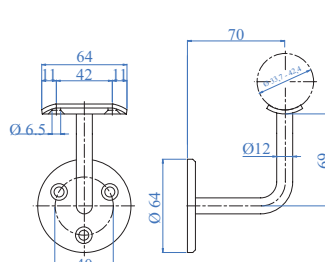

Art. F011976
25 x 64 mm
flat surf. - sup. piana
∠ 4 mm

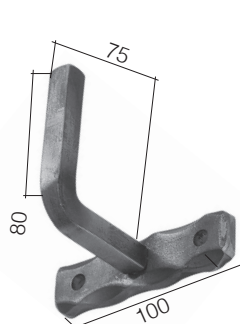

Art. 1405/1
Base 25 x 8 mm
holes-foresi Ø 8,5 mm
∅ 12 x 12 mm

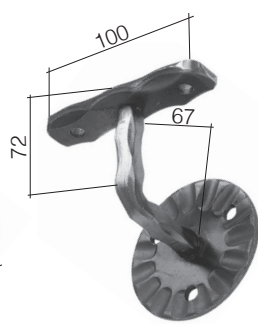

Art. 1405/2
Base Ø 80 x 4 mm
holes-foresi Ø 8,5 mm
∅ 12 x 12 mm

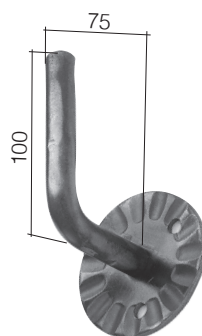

Art. 1405/3
Base Ø 80 x 4 mm
holes-foresi Ø 8,5 mm
Ø 16 mm



Art. 94/A/1
90 x 160 mm



Art. 94/A/2
90 x 160 mm



Art. 116/33
16 x 16 mm
H 110 mm
L 150 mm
lathed-tornito Ø 14 mm

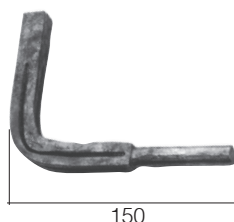

Art. 116/34
16 x 16 mm
H 110 mm
L 150 mm
lathed-tornito Ø 14 mm



Art. 116/35
Ø 65 mm
∠ 8 mm
hole - foro Ø 15 mm

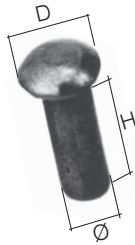

Art.	Ø	H	D
41/17/C	6 mm	20 mm	11 mm
41/18/C	6 mm	25 mm	11 mm
41/19/C	6 mm	30 mm	11 mm
41/20/C	6 mm	35 mm	11 mm
41/21/C	6 mm	40 mm	11 mm
41/22/C	6 mm	45 mm	11 mm
41/13/C	7 mm	25 mm	11 mm
41/14/C	8 mm	8 mm	16 mm
41/15/C	8 mm	20 mm	16 mm
41/1/C	8 mm	25 mm	16 mm
41/4/C	8 mm	30 mm	16 mm
41/5/C	8 mm	35 mm	16 mm
41/6/C	8 mm	40 mm	16 mm
41/16/C	8 mm	45 mm	16 mm
41/8/C	8 mm	60 mm	16 mm

**ORNAMENTAL RIVETS
CHIODI ORNAMENTALI**



**STUDS
BROCCHIE DI COPERTURA**



These items appeared scenes of the film "Sangue Del Tuo Sangue" (2015) by Marco Bellocchio, which was shown at the 72nd Venice International Film Festival.

Questi articoli compaiono nelle scene del film Sangue del tuo sangue (2015) di Marco Bellocchio, presentato alla 72° Mostra Internazionale del Cinema di Venezia.



/C = confezione da 5 kg

**FORGED RIVETS
CHIODI FORGIATI**



Art.	Head Testa	Shank Sotto testa \square	H
1474/7	30 mm	12 x 12 mm	L 210 mm
1474/10	13 mm	5 x 5 mm	L 70 mm

**RIVET HEADS TO BE WELDED
TESTE DI RIBATTINI TORNITE A SALDARE**



**SELF-TAPPING SCREWS - VITI AUTOFILETTANTI
forged head - testa forgiata**



Art.	Head Testa \square	Thread MA Filetto MA	H
695/6	30 x 30 mm	10 mm	90 mm
695/7	22 x 22 mm	8 mm	75 mm
695/8	16 x 16 mm	8 mm	62 mm

Art.	Head Testa	Thread MA Filetto MA	H
695/9	Ø 35 mm	10 mm	90 mm
695/10	Ø 24 mm	8 mm	85 mm
695/11	Ø 18 mm	8 mm	62 mm

Art.	Diameter Diametro	Hole Foro
697/5	Ø 16 mm	Ø 8 mm
697/7	Ø 12 mm	Ø 6 mm

Length of the chains
Lunghezza delle catene
= 10.000 mm (10 mt.)



Art. 156/A/8
5 x 5 mm



Art. 156/A/10
5 x 5 mm

Even today, most
of the accessories
are produced manually
just like they were in 1971

Ancora oggi
la gran parte degli
accessori vengono
prodotti manualmente
come nel 1971





Art. 1476/A/1
without key hole
senza foro

Art. 1476/A/9
without key hole
senza foro

c = 82 mm - d = 153 mm
e = 135 mm - f = 50 mm
g = 235 mm - m = 60,5 mm
(couple-coppia)



Art. 1476/A/10
without key hole
senza foro

c = 85 mm - d = 155 mm
e = 140 mm - f = 57 mm
g = 240 mm - m = 60,5 mm
(couple-coppia)



Art. 1476/A/11
without key hole
senza foro

c = 80 mm - d = 150 mm
e = 140 mm - f = 60 mm
g = 230 mm - m = 60,5 mm
(couple-coppia)

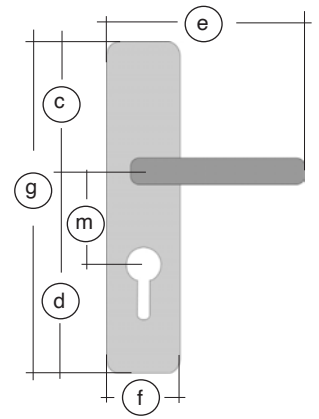

Art. 1476/A/5
with key hole
con foro

c = 85 mm - d = 155 mm
e = 142 mm - f = 45 mm
g = 240 mm - m = 60,5 mm
(couple-coppia)



Art. 1476/A/14
without key hole
senza foro

c = 80 mm - d = 150 mm
e = 142 mm - f = 50 mm
g = 230 mm - m = 60,5 mm
(couple-coppia)



Art. 1476/A/15
without key hole
senza foro

c = 80 mm - d = 157 mm
e = 150 mm - f = 58 mm
g = 237 mm - m = 60,5 mm
(couple-coppia)



Art. 1476/A/3
with key hole
con foro

c = 80 mm - d = 150 mm
e = 140 mm - f = 60 mm
g = 230 mm - m = 60,5 mm
(couple-coppia)



Art. 1476/A/4
with key hole
con foro

c = 95 mm - d = 165 mm
e = 133,5 mm - f = 53 mm
g = 260 mm - m = 60,5 mm
(couple-coppia)



Art. 1476/A/8
with key hole
con foro

c = 125 mm - d = 180 mm
e = 160 mm - f = 55 mm
g = 305 mm - m = 60,5 mm
(couple-coppia)

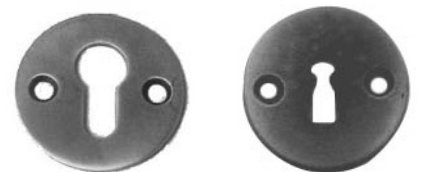

rosettes for locks
placche per serratura

Art. 1476/11
Ø 52,5 mm
thick.sp. 3 mm

Art. 1476/12
Ø 52,5 mm
thick.sp. 3 mm



Art. 169/12
70 x 135 mm
(couple-coppia)



Art. 169/15
40 x 110 mm
(couple-coppia)
handle complete with rosette
maniglia completa di rosetta



Art. 169/14
70 x 135 mm
(couple-coppia)
handle complete with rosette
maniglia completa di rosetta



Art. 169/11
70 x 125 mm
(couple-coppia)
handle complete with rosette
maniglia completa di rosetta



Art. 833/2
Ø 53 mm
(couple-coppia)



Art. 1475/7
37 x 75 mm
Plain-Liscio



Art. 833/6
240 x 260 mm
(couple-coppia)



Art. 834/3
265 x 80 mm
(couple-coppia)

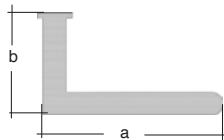

Art. 1476/1
a = 129 - b = 100 mm
(coppia - couple)



Art. 1476/5
a = 135 - b = 78 mm
(coppia - couple)



Art. 1476/7
a = 133 - b = 75 mm
(coppia - couple)



Art. 1476/8
a = 149 - b = 100 mm
(coppia - couple)



Art. 1475/6
220 x 50 mm



Art. 168/2
250 x 56 mm



Art. 832/1
265 x 60 mm



Art. 832/3
295 x 60 mm



Art. 832/6
265 x 75 mm



Art. 832/4/DX
280 x 60 mm
fisso / fixed



Art. 832/4/SX
280 x 60 mm
fisso / fixed



Art. 832/7
265 x 60 mm



Art. 832/8
255 x 65 mm



Art. 833/7
240 x 50 mm



Art. 833/8
250 x 53 mm



Art. 833/9
265 x 50 mm



Art. 836/5
225 x 60 mm



Art. 836/6
270 x 40 mm



Art. 836/7
280 x 40 mm



Art. 836/8
255 x 50 mm



Art. 836/9
255 x 50 mm



Art. 168/4
250 x 38 mm
(couple-coppia)



Art. 836/1
250 x 50 mm
(couple-coppia)



Art. 1474/2
fixed handle
maniglione fisso
H 340 mm
rosette - rosettes
Ø 90 mm

KNOBS - BATTENTI



Art. 837/3
Ø 100 mm
rosette - rosetta
Ø 60 mm



Art. 837/2
Ø 150 mm
rosette - rosetta
Ø 80 mm



Art. 1474/4
Ø 120 mm
base Ø 90 mm



Art. 170/A/5
49 x 43 mm



Art. 170/A/10
49 x 43 mm



Art. 170/A/1
31 x 121 mm



Art. 170/A/7
48 x 48 mm



Art. 170/A/9
48 x 48 mm



Art. 834/2
Ø 67 mm



Art. 170/1
Ø 65 mm



Art. 170/2
Ø 65 mm



Art. 170/3
Ø 50 mm



Art. 170/5
Ø 50 mm



Art. 839/5
85 x 35 mm
∇ 2 mm



Art. 839/6
85 x 35 mm
∇ 2 mm



Art. 839/7
85 x 35 mm
spess. 2 mm
hole-foro Ø 14 mm



Art. 839/8
70 x 35 mm
∇ 2 mm



Art. 169/8
265 x 48 mm

TOPS - POMOLI

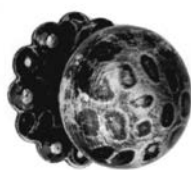

Art. 169/1
Ø 68 mm
rotating-girevole
(couple-coppia)

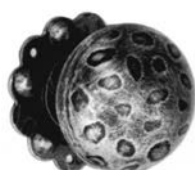

Art. 169/2
Ø 60 mm
fixed-fisso



Art. 834/1
Ø 67 mm
H 75 mm
rotating-girevole
(couple-coppia)



Art. 838/1
57 x 57 mm
H 70 mm
rotating-girevole
(couple-coppia)



Art. 181/10
285 x 105 mm
∅ 30 mm

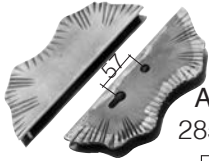

Art. 181/11
285 x 105 mm
∅ 30 mm



Art. 181/12
Double-lock latch
Serratura doppia mandata



Art. 6258/4
Lock for gates
Serratura per cancelli

**YALE LOCKS
BLOCCHETTI YALE**



Art. 181/15



Art.841/1
275 x 160 mm
sp./thickness 3 mm

Art.841/2
275 x 160 mm
sp./thickness 3 mm



Art.841/5
210 x 290 mm
spessore/thickness 4 mm

BOLTS - CATENACCI



Art. 840/4
30 x 160 mm



power hammered
magliato



Art. 830/1
Ø 22 mm
H 100 mm
thread - filetto
14MA mm

power hammered
magliato



Art. 181/13
Ø 38 mm
H 230 mm
thread - filetto
22MA mm
Art. 181/14
Ø 32 mm
H 175 mm
thread - filetto
18MA mm



Art. 34/3
12 x 12 mm
H 175 mm
L 110 mm

Welding hinge
Cardine a saldare



Art. 164/1
thread - filetto
18MA mm
Art. 830/17
thread - filetto
27MA mm

Wall hinge
Cardine a muro



Art. 164/4
thread - filetto
22MA
Art. 830/18
thread - filetto
27MA mm

Hinge with orthogonal regulation
opening of up to 180°
Cardine a regolazione ortogonale
con apertura fino a 180°

Art. 830/20
thread - filetto
22MA mm
Art. 830/21
thread - filetto
27MA mm

Passing hinge
Cardine passante



Art. 830/3
thread - filetto
20MA mm



Art. 164/5
thread - filetto
18MA mm



latches/light hinges for furniture
catenacci/cerniere leggeri per mobili

Art. 170/A/2
68 x 125 x 2 mm



Polished - Lucido
Art. 830/7
H 89 mm - Ø 28 mm



Galvanized - Zincato
Art. 830/9
H 89 mm - Ø 23 mm
Art. 830/10
H 89 mm - Ø 28 mm

Pivot
Perno



With hinge
Con cardine
18MA
Art. 164/7
to be coupled with
da abbinare con
Art. 164/9
With hinge
Con cardine
22MA
Art. 164/8
to be coupled with
da abbinare con
Art. 164/10

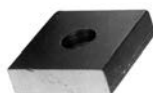

Polished - Lucido
Art. 830/13
H 20 mm - L 80 mm



Galvanized - Zincato
Art. 830/16
H 20 mm - L 80 mm

Plate
Piastra

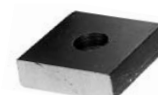

With hinge
Con cardine
22MA
Art. 164/10



Arterferro supplies paints and patinas for finishing your wrought ironwork, both indoors and outdoors. They can be used to colour handrails, stairs, gates, bars, fences and other decorative elements in forged iron.

Arterferro mette a disposizione vernici e patine per rifinire al meglio le vostre realizzazioni in ferro battuto, sia in interni che in esterni. Possono essere utilizzate per la colorazione di corrimani, scale, cancelli, inferriate, recinzioni ed altri elementi decorativi in ferro forgiato.

Varnishes - Vernici

Arterferro **paints**, available either as transparent varnishes or coloured paints, provide a finishing and at the same time prevent the natural deterioration of metal caused by atmospheric agents. To obtain better and longer lasting results, we recommend you to "prepare" the iron using other Arterferro products such as nitro thinner or an iron brush.

Le **vernici** Arterferro, disponibili sia trasparenti che colorate, rifiniscono e al contempo prevengono il naturale deterioramento del metallo dovuto agli agenti atmosferici. Per ottenere risultati migliori e duraturi consigliamo di "preparare" il ferro utilizzando gli altri prodotti Arterferro come il diluente nitro o la spazzola per ferro.

Patinas - Patine

Arterferro **patinas** are special paints, very opaque and dense, which allow an elegant oxidation effect to be produced on the metal, thus giving the painted product a refined style with a thick decorative finish. Available in gold, copper, silver and green, they can be applied after painting as well as directly onto the iron.

Le **patine** Arterferro sono vernici particolari, molto coprenti e dense, che consentono di riprodurre un elegante effetto ossidazione sul metallo, conferendo così al prodotto verniciato uno stile ricercato di grande spessore decorativo. Disponibili in colore oro, rame, argento e verde possono essere applicate dopo la verniciatura ma anche direttamente sul ferro.



Rust colour coating
Ruggine trasparente
Art. 227/54 Lt. 2,50



Gold patina
Patina oro
Art. 227/29 Lt. 0,25



Copper patina
Patina rame
Art. 227/30 Lt. 0,25



Green patina
Patina verde
Art. 227/31 Lt. 0,25



Silver patina
Patina argento
Art. 227/32 Lt. 0,25



Pale gold patina
Patina oro pallido
Art. 227/51 Lt. 0,25



Antique gold patina
Patina oro antico
Art. 227/52 Lt. 0,25



Verdigris mat patina
Patina verde rame opaco
Art. 227/30 Lt. 0,25



Art. 849/1
Aluminium - White colour
Alluminio - Colore bianco



Art. 849/2
Aluminium - Black colour
Alluminio - Colore nero



Art. 849/3
Aluminium - Red colour
Alluminio - Colore rosso



Art. 849/4
Aluminium - Green colour
Alluminio - Colore verde

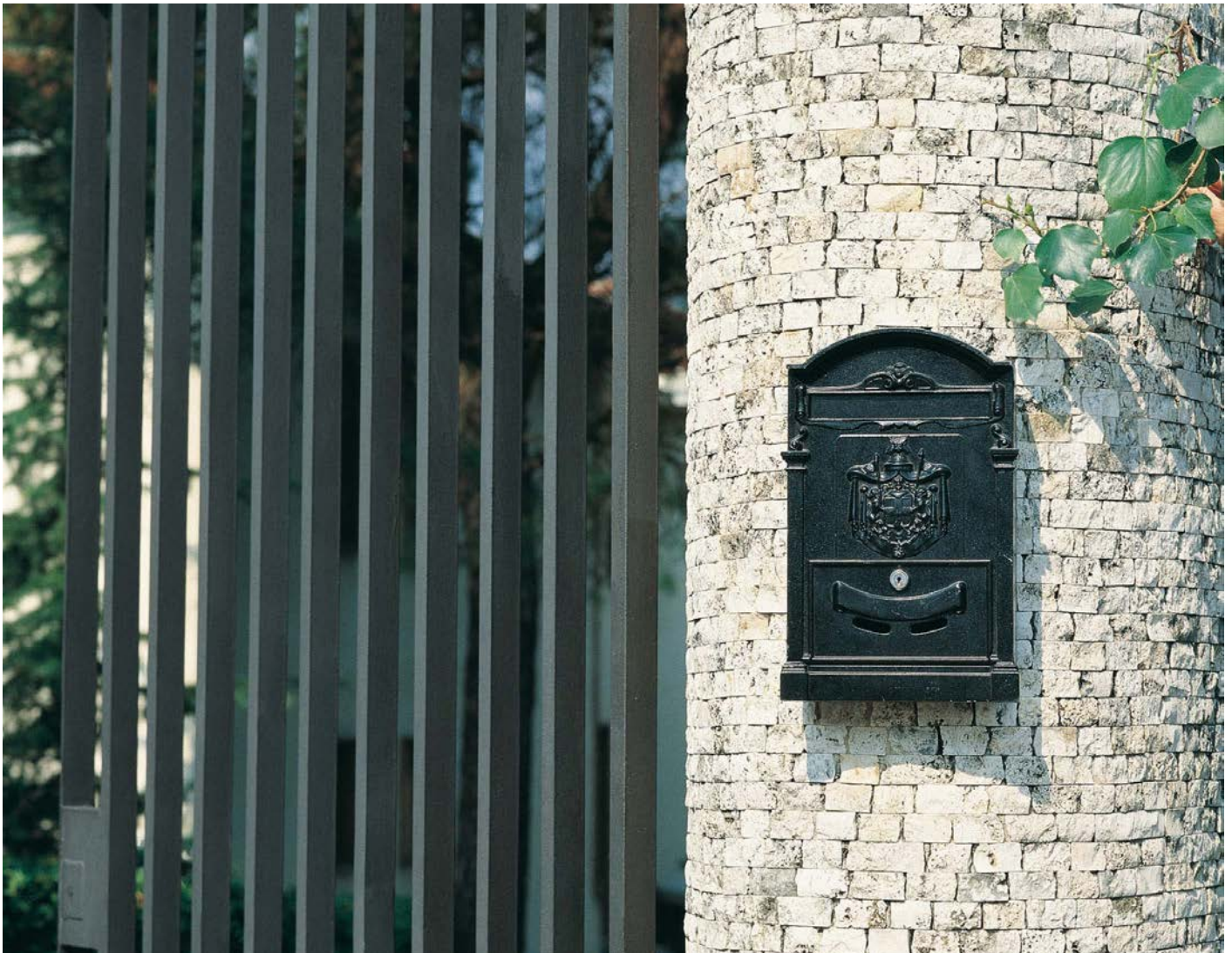

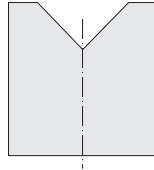
"V" groove
gola a "V"light model with nr. 1 bearing
serie leggera - n. 1 cuscinetto

Art.	Diam. Ø	Thickness Spessore	Capacity Portata
844/1	50 mm	20 mm	200 Kg
844/2	60 mm	20 mm	300 Kg
844/3	70 mm	20 mm	300 Kg
844/34	75 mm	20 mm	300 Kg
844/4	80 mm	20 mm	300 Kg
844/5	90 mm	20 mm	300 Kg
844/6	100 mm	20 mm	300 Kg
844/7	120 mm	20 mm	300 Kg
844/8	140 mm	20 mm	300 Kg
844/9	160 mm	20 mm	300 Kg

heavy model with nr. 2 bearings
serie pesante - n. 2 cuscinetti

Art.	Diam. Ø	Thickness Spessore	Capacity Portata
844/10	100 mm	30 mm	600 Kg
844/11	120 mm	30 mm	600 Kg
844/12	140 mm	30 mm	600 Kg
844/13	160 mm	30 mm	800 Kg
844/14	200 mm	30 mm	800 Kg

heavy model with grease receiver
- nr. 2 bearings -
serie pesante con ingrassatore
- n. 2 cuscinetti -

Cod. Art. Art. no.	Ø/dia	SPESSORE WIDTH	PORTATA CAPACITY
844/15	90 mm	30 mm	600 Kg
844/16	100 mm	30 mm	600 Kg
844/17	120 mm	30 mm	600 Kg
844/18	140 mm	30 mm	600 Kg
844/19	160 mm	30 mm	600 Kg

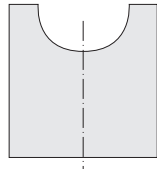
"rounde" groove
gola a "raggio"heavy model - 10 mm
serie pesante - 10 mm

Art.	Diam. Ø	Thickness Spessore	Capacity Portata
844/29	100 mm	30 mm	600 Kg
844/30	120 mm	30 mm	600 Kg
844/33	200 mm	30 mm	600 Kg

Light Model - 7,5 mm
Serie Leggera - 7,5 mm

Art.	Diam. Ø	Thickness Spessore	Capacity Portata
844/20	50 mm	20 mm	300 Kg
844/22	70 mm	20 mm	300 Kg
844/23	80 mm	20 mm	300 Kg
844/24	90 mm	20 mm	300 Kg
844/25	100 mm	20 mm	300 Kg
844/26	120 mm	20 mm	300 Kg
844/28	160 mm	20 mm	300 Kg

cylindrical upper
guiding weels
for gates dia. 30 mm
ruote guida superiori
cilindriche Ø 30 mm

Art. 845/17

cylindrical upper
guiding weels
for gates dia. 35 mm
ruote guida
superiori cilindriche
Ø 35 mm

Art. 846/4



“V” groove
gola a “V”

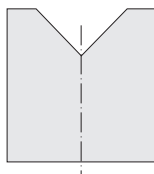

wheels with internal support model “F”
ruote con supporto interno tipo “F”

Art.	Diam. Ø	Thickness Spessore	Bearings Cuscinetti	Capacity Portata
845/2	90 mm	20 mm	1	300 Kg
845/3	100 mm	20 mm	1	300 Kg
845/4	120 mm	20 mm	1	300 Kg
845/5	120 mm	30 mm	2	600 Kg
845/6	140 mm	20 mm	1	300 Kg
845/7	140 mm	30 mm	2	600 Kg

gate guiding plate
200 mm - 4 guiding bearing
piastrine guida per cancello
200 mm - 4 olive



Art. 845/18

gate guiding plate
60 mm - 4 guiding bearing
piastrine guida per cancello
60 mm - 4 olive

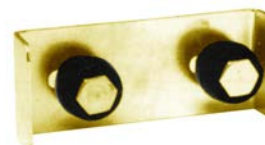

Art.845/19



“U” groove
gola a “U”

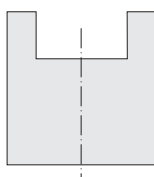

light model - serie leggera

Art.	Ø/d Diam. Ø mm	Thickness Spessore	Groove Gola	Bearings Cuscinetti	Capacity Portata
846/6	60 mm	17 mm	6 mm	1	100 Kg

heavy model - serie pesante

Art.	Ø/dia	Thickness Spessore	Groove Gola	Bearings Cuscinetti	Capacity Portata
846/13	90 mm	25 mm	16 mm	1	200 Kg
846/14	120 mm	30 mm	21 mm	1	400 Kg



“U” groove
gola a “U”

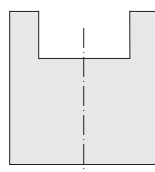

Art.	Ø/dia	Thickness Spessore	Groove Gola	Bearings Cuscinetti	Capacity Portata
846/18	75 mm	25 mm	13 mm	1	200 Kg
846/19	75 mm	25 mm	16 mm	1	200 Kg

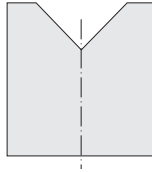
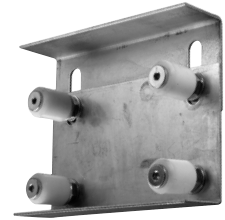
"V" groove
gola a "V"gate guiding plate
4 guiding bearing
piastrine guida per cancello
4 olive

Art.846/5

Art.	Ø/dia	Thickness Spessore	Bearings Cuscinetti	Capacity Portata
846/21	75 mm	25 mm	1	200 Kg
846/22	100 mm	25 mm	2	400 Kg

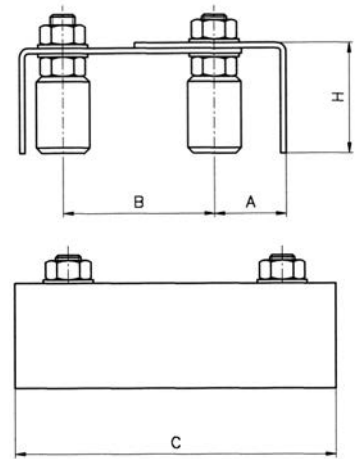
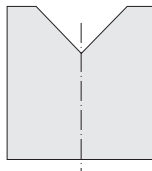
"V" groove
gola a "V"wheels with internal support model "I"
ruote con supporto interno tipo "I"

Art.	Ø/dia	Thickness Spessore	Groove Gola	Bearings Cuscinetti	Capacity Portata
845/8	60 mm	20 mm	20 mm	1	300 Kg
845/9	70 mm	20 mm	20 mm	1	300 Kg
845/10	80 mm	20 mm	20 mm	1	400 Kg
845/12	100 mm	20 mm	20 mm	1	400 Kg
845/13	120 mm	20 mm	20 mm	1	400 Kg
845/14	120 mm	30 mm	30 mm	2	600 Kg
845/15	140 mm	20 mm	20 mm	1	400 Kg
845/16	140 mm	30 mm	30 mm	2	600 Kg

A	40 ÷ 80 mm
B	40 ÷ 50 mm
C	220 mm
H	59 mm

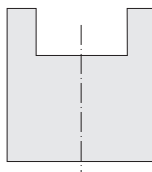
"U" groove
gola a "U"

Art.	Ø/dia	Thickness Spessore	Groove Gola	Bearings Cuscinetti	Capacity Portata
845/26	75 mm	18 mm	8 mm	1	180 Kg





Alluminium

Alluminio

Arteferro has a wide range of aluminium elements in its production. It is a silver-colored ductile metal and its softness, lightness and resistance to oxidation is remarkable, due to the formation of a very thin layer of oxide that prevents oxygen from corroding the underlying metal.

Arteferro vanta tra la sua produzione una vasta serie di elementi in alluminio. Si tratta di un metallo duttile color argento ed è notevole la sua morbidezza, la sua leggerezza e la sua resistenza all'ossidazione, dovuta alla formazione di un sottilissimo strato di ossido che impedisce all'ossigeno di corrodere il metallo sottostante.

arteferro

18 Aluminium - Alluminio

18.A Long bars pag.378
Barre Lunghe

18.B Forged pickets pag.379
Paletti forgiati

18.C Stamped pickets, with baskets and twisted pag.381
Paletti conati, con pigne e con torciglione

18.D Panels and Bowed pickets pag.382
Pannelli e Pancioni

18.E Various element pag.383
Elementi vari



Hammered 4 edges
Battuto 4 spigoli
Art. 772/5
□ 25 x 25 mm
L 3000 mm



Hammered 2 edges
Spigolato 2 spigoli
Art. 772/6
□ 40 x 8 mm
L 3000 mm



Hamm. 2 sides and 4 edges
Battuto 2 lati e 4 spigoli
Art. 1447/8
□ 30 x 8 mm
L 3000 mm



Art. 1447/9
□ 53 x 9 mm
L 3000 mm



Art. 1447/10
□ 47 x 10 mm



Art. 772/3
□ 14 x 4 mm
L 3000 mm

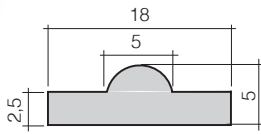

Art. 1871/1
□ 20 x 20 x 2 mm
L 6000 mm



Art. 1871/5
□ 40 x 20 x 2 mm
L 6000 mm



Art. 1447/6
□ 40 x 8 mm
L 3000 mm

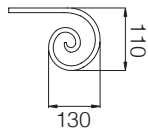

Art. 772/1
for handrail
per corrimano
art.1447/6



Art. 1447/5
□ 40 x 8 mm
L 3000 mm

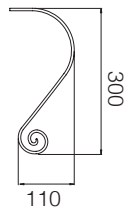

Art. 1427/21
for handrail
per corrimano
art.1447/5

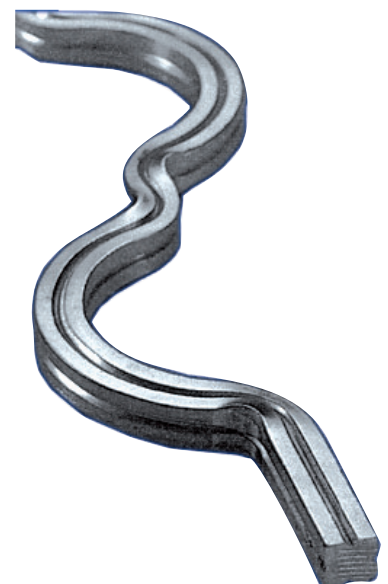

Art. 772/17
□ 14 x 14 mm
L 1600 mm



Art. 1445/4
□ 12 x 12 mm
H 1000 mm



Art. 1445/3
□ 12 x 12 mm
H 1000 mm



Art. 1445/1
□ 14 x 14 mm
H 1000 mm



Art. 1446/6
Ø 12 mm
H 1000 mm



Art. 1446/5
Ø 12 mm
H 1000 mm



Art. 1446/4
□ 12 x 12 mm
H 1000 mm



Art. 1446/3
□ 12 x 12 mm
H 1000 mm



Art. 1446/2
□ 12 x 12 mm
H 1000 mm



Art. 1446/1
H 1000 mm

Newel Post - Caposaldo



Art. 1448/2
□ 30 x 30 mm
H 1200 mm



Art. 1448/1
Ø 30 mm
H 1200 mm



Art. 769/11
□ 25 x 25 mm
H 1200 mm



Art. 768/7
□ 14 x 14 mm
110 x 1000 mm



Art. 768/9
□ 14 x 14 mm
210 x 1000 mm



Art. 768/4
□ 14 x 14 mm
H 1000 mm



Art. 768/5
□ 14 x 14 mm
H 1000 mm



Art. 769/6
□ 14 x 14 mm
300 x 1000 mm



Art. 769/5
□ 14 x 14 mm
180 x 1000 mm

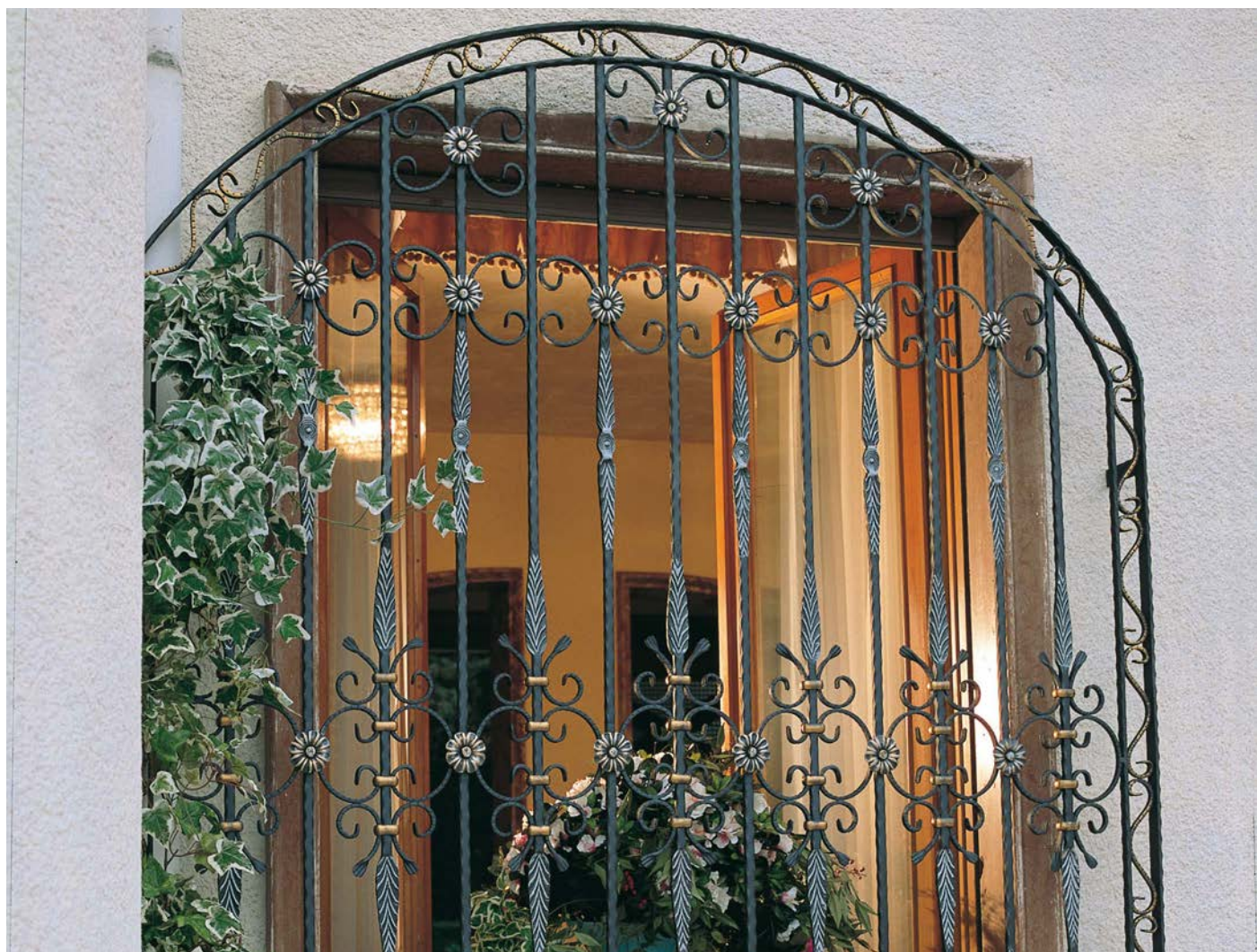



Art. 1444/11
□ 16 x 16 mm
H 1000 mm



Art. 769/8
□ 14 x 14 mm
H 1000 mm



Art. 769/7
□ 14 x 14 mm
H 1000 mm



Art. 1869/6
□ 14 x 14 mm
H 1000 mm



Art. 1440/2
□ 16 x 16 mm
65 x 1000 mm



Art. 1440/1
□ 16 x 16 mm
65 x 1000 mm





Art. 1869/5
 \varnothing 12 x 12 mm
 185 x 1000 mm



Art. 567/1
 \varnothing 12 x 6 mm
 350 x 870 mm
 Plain - Liscio



Art. 1438/1
 \varnothing 14 x 14 mm
 370 x 900 mm



Art. 1869/2
 \varnothing 14 x 14 mm
 350 x 900 mm



Art. 768/6
 \varnothing 14 x 14 mm
 30 x 1000 mm



Art. 769/4
 \varnothing 14 x 14 mm
 H 1000 mm



200 mm

Art. 1870/3
 plain/liscio
 \varnothing 40 x 8 mm
 H 1000 mm



Art. 1444/8
 \varnothing 40 x 8 mm
 200 x 1000 mm



Art. 1870/1
 \varnothing 40 x 8 mm
 200 x 1000 mm



Art. 770/8
12 x 6 mm
75 x 120 mm



Art. 770/9
12 x 6 mm
90 x 180 mm



Art. 770/10
12 x 6 mm
60 x 115 mm



Art. 1437/19
20 x 6 mm
90 x 185 mm



Art. 768/1
12 x 6 mm
90 x 105 mm



Art. 1867/5
14 x 14 mm
160 x 230 mm



Art. 770/14
12 x 6 mm
120 x 180 mm



Art. 770/12
12 x 6 mm
145 x 370 mm



Art. 770/5
12 x 6 mm
120 x 350 mm



Art. 770/4
12 x 6 mm
120 x 290 mm



Art. 770/3
12 x 6 mm
120 x 220 mm



Art. 1867/1
12 x 6 mm
Ø 330 mm



Art. 1867/3
12 x 6 mm
Ø 260 mm



Art. 772/10
14 x 14 mm
Ø 100 mm

Art. 772/11
14 x 14 mm
Ø 115 mm

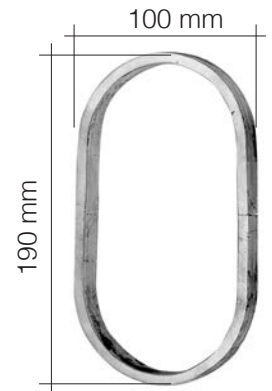

Art. 1443/4
20 x 6 mm

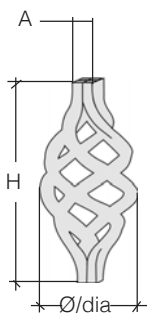

Art.	Ø	H	A
772/8	60 mm	130 mm	14 x 14 mm
1443/13	75 mm	150 mm	16 x 16 mm



Art. 771/6
Ø 20 mm



Art. 1869/11
Ø 40 mm
H 23 mm
foro/hole
15 x 15 mm



Art. 771/3
Ø 65 mm



Art. 1448/4
Ø 115 mm
hole/foro
Ø 10 mm
thick./spess 4 mm



Art. 1454/5
Ø 105 mm
spess./thick. 4 mm



Art. 1454/9
85 x 120 mm
Ø 12 mm
spess./thick. 4 mm



Art. 1454/10
85 x 120 mm
Ø 12 mm
spess./thick. 4 mm



Art. 1452/3
80 x 160 mm
Ø 12 mm
spess./thick. 4 mm



Art. 1452/4
80 x 160 mm
Ø 12 mm
spess./thick. 4 mm



Art. 1452/5
70 x 120 mm
Ø 12 mm
spess./thick. 4 mm



Art. 1452/6
70 x 120 mm
Ø 12 mm
spess./thick. 4 mm



Art. 1451/1
120 x 210 mm
spess./thick. 4 mm



Art. 1451/3
120 x 210 mm
thick./spess 4 mm



Art. 1451/4
120 x 210 mm
thick./spess 4 mm



Art. 1451/7
160 x 100 mm
thick./spess 4 mm



Art. 1451/9
150 x 220 mm
thick./spess 4 mm



Art. 1451/10
150 x 220 mm
thick./spess 4 mm



Art. 1452/1
160 x 100 mm
thick./spess 4 mm



Art. 1454/11
130 x 180 mm
thick./spess 4 mm



Art. 1454/12
130 x 180 mm
thick./spess 4 mm



Art. 1454/13
180 x 150 mm
thick./spess 4 mm



Art. 1454/14
180 x 150 mm
thick./spess 4 mm



Art. 1454/15
150 x 160 mm
thick./spess 4 mm



Art. 1454/16
150 x 160 mm
thick./spess 4 mm



Art. 1450/1
85 x 270 mm
thick./spess 4 mm



Art. 1450/8
80 x 160 mm
thick./spess 4 mm



Art. 1450/9
95 x 170 mm
thick./spess 4 mm



Art. 1450/4
110 x 230 mm
thick./spess 4 mm



Art. 1450/3
50 x 180 mm
thick./spess 4 mm



Art. 1450/6
95 x 120 mm
thick./spess 4 mm



Art. 1450/10
95 x 150 mm
thick./spess 4 mm



Art. 1454/1
70 x 140 mm
Ø 12 mm
thick./spess 4 mm



Art. 1452/9
80 x 100 mm
Ø 12 mm
thick./spess 4 mm



Art. 1452/10
80 x 100 mm
Ø 12 mm
thick./spess 4 mm



Art. 1454/2
70 x 200 mm
Ø 12 mm
thick./spess 4 mm



Art. 1453/1
155 x 390 mm
thick./spess 4 mm



Art. 1453/2
110 x 360 mm
thick./spess 4 mm



Art. 1453/3
110 x 360 mm
thick./spess 4 mm



Art. 1453/4
77 x 240 mm
thick./spess 4 mm



Art. 1454/3
Ø 12 mm
220 x 115 x 4 mm



Art. 1454/4
Ø 12 mm
250 x 80 x 4 mm



Galvanized *Zincati*

Arteferro also adds galvanised products to its wide range. Cold galvanising is considered a technique similar to painting, so it is applied as a normal primer paint with antioxidant power linked to the galvanic action of zinc, due to the effect of electrolysis. This treatment is carried out at a temperature of approximately 20-25 °C, distinguishing itself from the hot one in which it is worked at 450 °C. For this reason it is particularly suitable for thin sheets, thus avoiding deformation of the material.

Arteferro aggiunge nella sua vasta gamma anche i prodotti zincati. La zincatura a freddo è considerata una tecnica assimilabile alla verniciatura per cui viene applicata come una normale vernice di fondo con potere antiossidante legato all'azione galvanica dello zinco, per effetto dell'elettrolisi. Questo trattamento viene effettuato ad una temperatura di circa 20-25 °C, distinguendosi da quella a caldo nella quale si lavora a 450 °C. Per questo motivo è particolarmente indicato per lamiere sottili, evitando così la deformazione del materiale.

arteferro

19 Galvanized - Zincati

19.A Long bars	pag.388
Barre Lunghe	
19.B Handrail and End pieces	pag.390
Corrimani e Partenze	
19.C Pierced bars	pag.391
Barre forate	
19.D Embossed metal sheet	pag.392
Lamere bugnate	
19.E Bushes and Plates	pag.394
Borchie e Piastre	
19.F Scrolls and Bowed pickets	pag.395
Ricci e Pancioni	



**COLD GALVANIZED ROUND BARS
BARRE TONDE ZINCATE A FREDDO**



Section Sezione	Length Lunghezza	Plain Liscio
	Art.	Art.
Ø 8 mm	6000 mm	1368/7/6000/Z
Ø 10 mm	6000 mm	1368/8/6000/Z
Ø 12 mm	6000 mm	1368/9/6000/Z
Ø 14 mm	6000 mm	1368/10/6000/Z
Ø 16 mm	6000 mm	1368/23/6000/Z
Ø 18 mm	6000 mm	1368/24/6000/Z

**COLD GALVANIZED FLAT BARS
BARRE PIATTE ZINCATE A FREDDO**



Section Sezione	Length Lunghezza	Plain Liscio
	Art.	Art.
20 x 3 mm	6000 mm	1368/46/6000/Z
20 x 4 mm	6000 mm	1368/15/6000/Z
20 x 5 mm	6000 mm	1368/47/6000/Z
20 x 6 mm	6000 mm	1368/16/6000/Z
20 x 10 mm	6000 mm	1368/49/6000/Z
25 x 3 mm	6000 mm	1368/51/6000/Z
25 x 4 mm	6000 mm	1368/17/6000/Z
25 x 5 mm	6000 mm	1368/52/6000/Z
25 x 8 mm	6000 mm	1368/54/6000/Z
30 x 3 mm	6000 mm	1368/107/6000/Z
30 x 4 mm	6000 mm	1368/56/6000/Z
30 x 5 mm	6000 mm	1368/57/6000/Z
30 x 8 mm	6000 mm	1368/18/6000/Z
30 x 10 mm	6000 mm	1368/59/6000/Z
40 x 3 mm	6000 mm	1368/111/6000/Z
40 x 4 mm	6000 mm	1368/70/6000/Z
40 x 5 mm	6000 mm	1368/71/6000/Z
40 x 8 mm	6000 mm	1368/19/6000/Z
50 x 5 mm	6000 mm	1368/83/S/6000/Z
50 x 8 mm	6000 mm	1368/85/6000/Z
50 x 10 mm	6000 mm	1368/86/6000/Z
60 x 4 mm	6000 mm	1368/90/6000/Z
60 x 5 mm	6000 mm	1368/106/6000/Z
60 x 10 mm	6000 mm	1368/93/6000/Z
100 x 6 mm	6000 mm	1368/115/6000/Z
120 x 6 mm	6000 mm	1368/117/6000/Z
150 x 6 mm	6000 mm	1368/113/6000/Z

**COLD GALVANIZED SHAPED BARS
BARRE SAGOMATE ZINCATE A FREDDO**



Section Sezione	Length Lunghezza	Plain Liscio
	Art.	Art.
40 x 11 mm	6000 mm	1373/4/6000/Z
50 x 14 mm	6000 mm	114/A/3/6000/Z

**COLD GALVANIZED SQUARE BARS
BARRE QUADRE ZINCATE A FREDDO**



Section Sezione	Length Lunghezza	Plain Liscio
	Art.	Art.
10 x 10 mm	6000 mm	1368/3/6000/Z
12 x 12 mm	6000 mm	1368/4/6000/Z
14 x 14 mm	6000 mm	1368/5/6000/Z
16 x 16 mm	6000 mm	1368/20/6000/Z

**COLD GALVANIZED CORNER BARS
BARRE ANGOLARI ZINCATE A FREDDO**



Section Sezione	Length Lunghezza	Plain Liscio
	Art.	Art.
20 x 3 mm	6000 mm	ANG20X3/ZINC/LAM
25 x 3 mm	6000 mm	ANG25X3/ZINC/LAM
25 x 4 mm	6000 mm	ANG25X4/ZINC/LAM
25 x 5 mm	6000 mm	ANG25X5/ZINC/LAM
30 x 3 mm	6000 mm	ANG30X3/ZINC/LAM
30 x 4 mm	6000 mm	ANG30X4/ZINC/LAM
30 x 5 mm	6000 mm	ANG30X5/ZINC/LAM
35 x 3 mm	6000 mm	ANG35X3/ZINC/LAM
35 x 5 mm	6000 mm	ANG35X5/ZINC/LAM
40 x 4 mm	6000 mm	ANG40X4/ZINC/LAM
40 x 5 mm	6000 mm	ANG40X5/ZINC/LAM
50 x 5 mm	6000 mm	ANG50X5/ZINC/LAM
60 x 6 mm	6000 mm	ANG60X6/ZINC/LAM

**COLD GALVANIZED "T" BARS
BARRE A "T" ZINCATE A FREDDO**



Section Sezione	Length Lunghezza	Plain Liscio
	Art.	Art.
30 x 4 mm	6000 mm	PT30X4/ZINC/LAM
35 x 5,5 mm	6000 mm	PT35X5/ZINC/LAM
40 x 5 mm	6000 mm	PT40/5/ZINC/LAM
60 x 5 mm	6000 mm	PT60/5/ZINC/LAM

**COLD GALVANIZED "L" BARS
BARRE A "L" ZINCATE A FREDDO**



Section Sezione	Length Lunghezza	Plain Liscio
	Art.	Art.
40 x 20 x 4 mm	6000 mm	PL40X20X4/ZINC/LAM
50 x 30 x 5 mm	6000 mm	PL50X30X5/ZINC/LAM
60 x 40 x 5 mm	6000 mm	PL60X40X5/ZINC/LAM

**END PIECES FOR COLD GALVANIZED HANDRAILS
PARTENZE PER CORRIMANI ZINCATI A FREDDO**

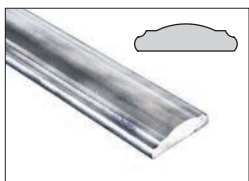



L 6000 mm	Section Sezione			
Art.		Art.	Art.	Art.
1373/4/6000/Z	40 x 11 mm	1817/9/Z	1817/5/Z	1817/1/Z
114/A/3/6000/Z	50 x 14 mm	114/B/13/Z	114/B/14/Z	114/B/15/Z



**COLD GALVANIZED PIERCED BARS
BARRE FORATE ZINCATE A FREDDO**

L 2.000 mm

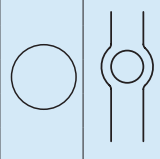

Round hole
Foro tondo

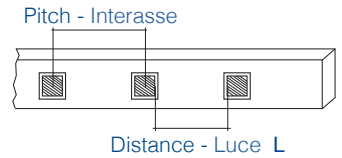
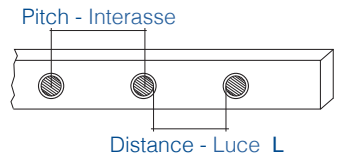
Section Sezione	Hole Foro	Section Ø Ø Sezione	Hole for Foro per	Pitch Interasse	Distance Luce	N. Holes N. Fori	Plain Liscio
							Art.
		12 mm	12 mm	120 mm	108 mm	16	1360/6/Z
		14 mm	14 mm	140 mm	126 mm	14	42/1/Z
		16 mm	16 mm	150 mm	134 mm	13	42/2/Z
		18 mm	18 mm	160 mm	142 mm	12	42/3/Z
		20 mm	20 mm	170 mm	150 mm	11	42/4/Z



L 2.000 mm

Square hole on the side
Foro quadro su lato

Section Sezione	Hole Foro	Section \square Sezione \square	Hole for Foro per	Pitch Interasse	Distance Luce	N. Holes N. Fori	Plain Liscio	Hammered Spigolato
							Art.	Art.
		12 mm	12 x 12 mm	120 mm	108 mm	16	1360/7/Z	1360/1/Z
		12 mm	12 x 12 mm	140 mm		14	-	-
		12 mm	12 x 12 mm	223 mm		8	-	-
		14 mm	14 x 14 mm	140 mm	126 mm	14	42/8/Z	1360/2
		14 mm	14 x 14 mm	124 mm	110 mm	14	42/A/5/Z	-
		14 mm	14 x 14 mm	140 mm	-	14	-	-
		15 mm	15 x 15 mm	160 mm	-	12	-	-
		16 mm	16 x 16 mm	150 mm	-	13	42/9/Z	-
		16 mm	16 x 16 mm	126 mm	110 mm	14	42/A/6/Z	-
		18 mm	18 x 18 mm	160 mm	142 mm	12	42/10/Z	-
		20 mm	20 x 20 mm	170 mm	150 mm	11	42/11/Z	-



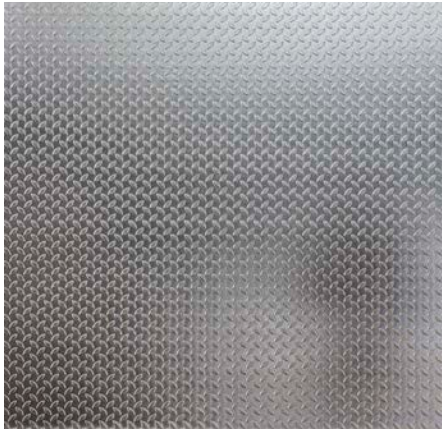



Section Sezione	Thickness Spessore	Art.
2000 x 1000 mm	2 mm	FLAMB200100/20/Z
2500 x 1250 mm	2 mm	FLAMB250125/20/Z
2000 x 1000 mm	2,5 mm	FLAMB200100/25/Z
2500 x 1250 mm	2,5 mm	FLAMB250125/25/Z
2000 x 1000 mm	3 mm	FLAMB200100/30/Z
2500 x 1250 mm	3 mm	FLAMB250125/30/Z
3000 x 1500 mm	3 mm	FLAMB300150/30/Z

**On request we can create
a customized infill**

**Su richiesta possiamo
creare un tamponamento
personalizzato**

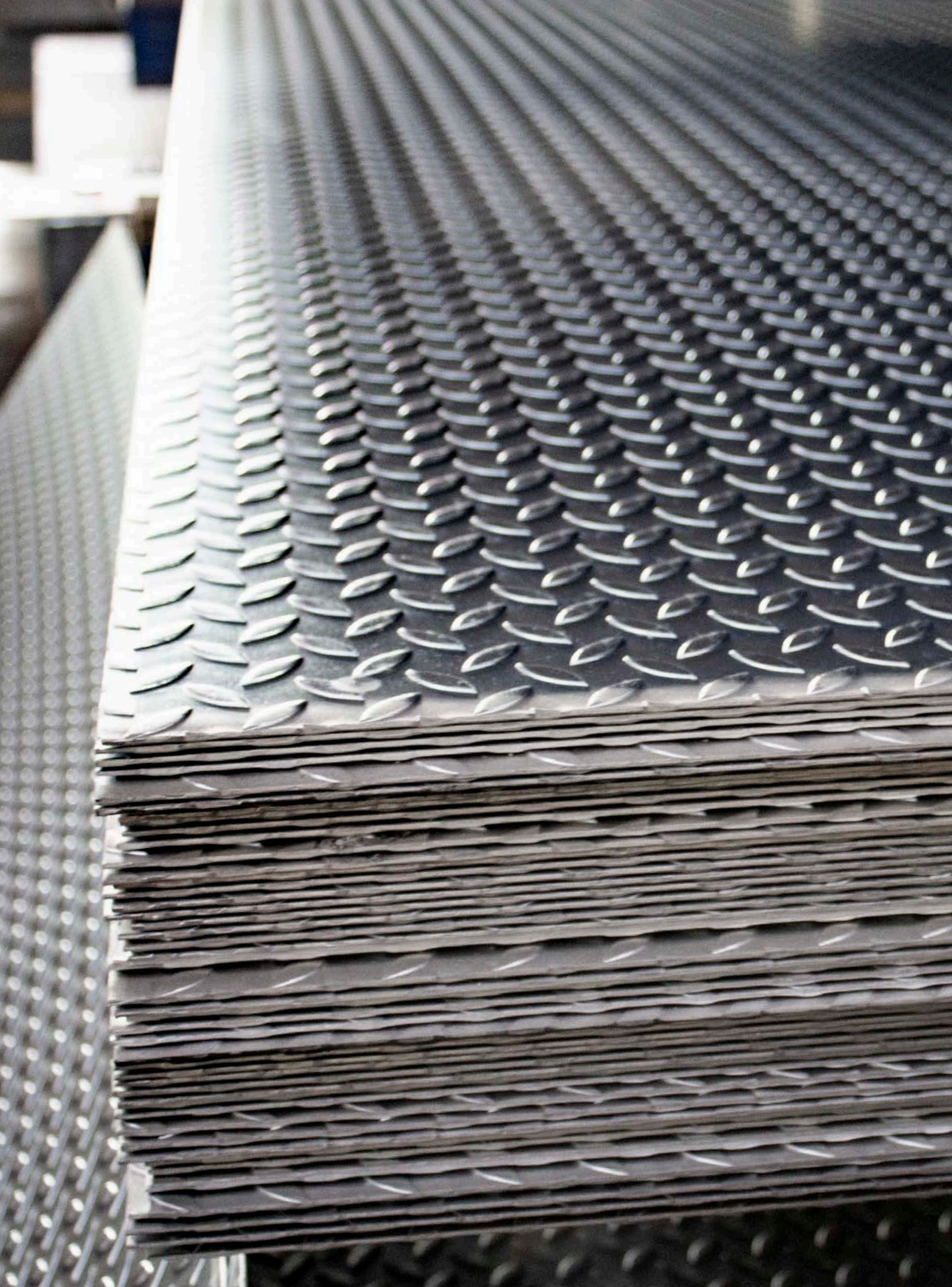



Dimensions Dimensioni	hole - foro		Hole - Foro	
	Section Sezione	Art.	Section Sezione	Art.
H 63 mm x Ø 38 mm	12 mm	128/6/Z	12 x 12 mm	747/12/Z
	14 mm	128/7/Z	14 x 14 mm	-
	16 mm	128/8/Z	16 x 16 mm	-
H 68 mm x Ø 45 mm	14 mm	-	14 x 14 mm	747/13/Z
	16 mm	128/9/Z	16 x 16 mm	-
H 78 mm x Ø 50 mm	16 mm	-	16 x 16 mm	747/14/Z

Dim.	Hole - Foro	Art.
	Hole for sec. - Foro per sez.	
H 65 mm L 40 mm	12 x 12 mm	1391/4/Z
	14 x 14 mm	1391/5/Z
	16 x 16 mm	1391/6/Z

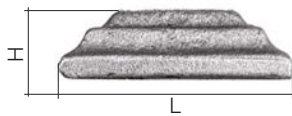

L/H	Hole - Foro	Art.
L 60 x 60 mm x H 19 mm	for - per \varnothing 25 x 25 mm	819/2/Z
	for - per \varnothing 30 x 30 mm	819/1/Z
L 80 x 80 mm x H 22 mm	for - per \varnothing 30 x 30 mm	819/15/Z
	for - per \varnothing 40 x 40 mm	819/16/Z



Art. 116/A/6/Z
100 x 100 mm
without hole
senza foro
 \varnothing 10 mm



Art. 116/A/7/Z
100 x 100 mm
hole - foro
 \varnothing 30 x 30 mm
 \varnothing 10 mm



Art. 47/34/Z
Ø 16 mm
H 1500 mm



Art. 1308/9/Z
Ø 16 mm
150 x 350 mm





Brass

Ottone

Arteferro offers a wide range of brass accessories in particular to decorate parts of gates, stairs or fences. Brass offers the perception of a "warm" furnishing decoration. Today, design wants to reward a backfire of this element that has been in fashion for most of the 20th century.

Arteferro propone un'ampia gamma di accessori in ottone in particolare per decorare parti di cancelli, scale o recinzioni. L'ottone offre la percezione di una decorazione d'arredo "calda". Oggi il design ha voluto premiare un "ritorno di fiamma" di questo elemento che è andato di moda per buona parte del '900

arteferro



20 Brass - Ottone

20.A	Long bars	pag.398
	Barre Lunghe	
20.B	Pickets and Panels	pag.399
	Paletti e Pannelli	
20.C	Baskets and Bushes	pag.400
	Pigne e Borchie	
20.D	Spear point	pag.402
	Lance	
20.E	Post tops	pag.403
	Pomoli	
20.F	Flower and Rosettes	pag.404
	Fiore e Rosette	



Art. 116/B/1
 ∇ 58 x 14 mm
 L 2000 mm
 Polished - Lucidato



110 Art. 116/B/2
 for handrail
 per corrimano
 Art. 116/B/1



Art. 1465/15



Art. 1464/14
 ∇ 14 x 4,5 mm
 L 4000 mm



Art. 1464/13
 ∇ 14 x 4,5 mm
 L 4000 mm



**Brass articles,
 unless otherwise
 specified, are
 supplied raw**

**Gli articoli in ottone
 se non diversamente
 specificato, sono
 forniti grezzi**



Art. 160/A/1
Ø 30 mm
H 360 mm
Tubo/Tube

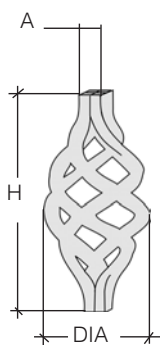

Art. 160/D/11
38 x 38 mm
H 40 mm
Hole/Foro
∅ 14 mm



Art. 160/B/6
∅ 70 mm
H 65 mm
Hole/Foro
∅ 40 mm



Art. 160/B/7
∅ 39 mm
H 60 mm
Hole/Foro
∅ 16,5 mm

Borchia in tubo
Bush from brass tube



Art. 160/B/1
∅ 40 mm
H 105 mm
Hole/Foro
∅ 16 mm



Art. 160/42
∅ 75 mm
H 185 mm
Hole/Foro
∅ 22 mm



Art. 744/7
∅ 45 mm
H 160 mm
Hole/Foro
∅ 16 mm



Art. 744/4
35 x 35 mm
H 93 mm
Hole/Foro
∅ 16 mm



Art. 160/D/12
∅ 40 mm
H 135 mm
Hole/Foro
∅ 16 mm

Brass articles,
unless otherwise
specified, are
supplied raw

Gli articoli in ottone
se non diversamente
specificato, sono
forniti grezzi



Ø 29 mm

Art. 160/B/2

Hole/Foro
Ø 12 mm

Art. 160/B/3

Hole/Foro
Ø 14 mm

Art. 160/B/4

Hole/Foro
Ø 16 mm

Art. 160/B/5

Hole/Foro
Ø 12 mm



Ø 35 mm

Art. 1466/4

H 35 mm
Hole/Foro

Ø 12 mm

Art. 1466/5

H 35 mm
Hole/Foro

Ø 14 mm



Ø 35 mm

Art. 1466/7

H 25 mm
Hole/Foro

Ø 12,5 mm



Art. 161/7

Ø 30 mm
H 60 mm
Hole/Foro

Ø 12 mm



Art. 161/17

Ø 20 mm
H 40 mm
Hole/Foro

Ø 12 mm



Art. 161/34

Ø 34 mm
H 26 mm
Hole/Foro

Ø 16 mm



Art. 743/5

Ø 48 mm
H 47 mm
Hole/Foro

Ø 10 mm



Art. 743/4

Ø 49 mm
H 48 mm
Hole/Foro

Ø 10 mm



Art. 743/1

Ø 50 mm
H 51 mm
Hole/Foro

Ø 10 mm



Art. 743/2

Ø 45 mm
H 55 mm
Hole/Foro

Ø 10 mm

Art. 743/10

Ø 35 mm
H 47 mm
Hole/Foro

Ø 10 mm

Brass articles,
unless otherwise
specified, are
supplied raw

Gli articoli in ottone
se non diversamente
specificato, sono
forniti grezzi



Brass articles,
unless otherwise
specified, are
supplied raw

Gli articoli in ottone
se non diversamente
specificato, sono
forniti grezzi



Art. 728/1
H 295 mm
Base Ø 35 mm



Art. 795/10
L 70 mm
H 120 mm
Filetto/Thread 6 MA



Art. 795/9
L 68 mm
H 75 mm
Filetto/Thread 6 MA

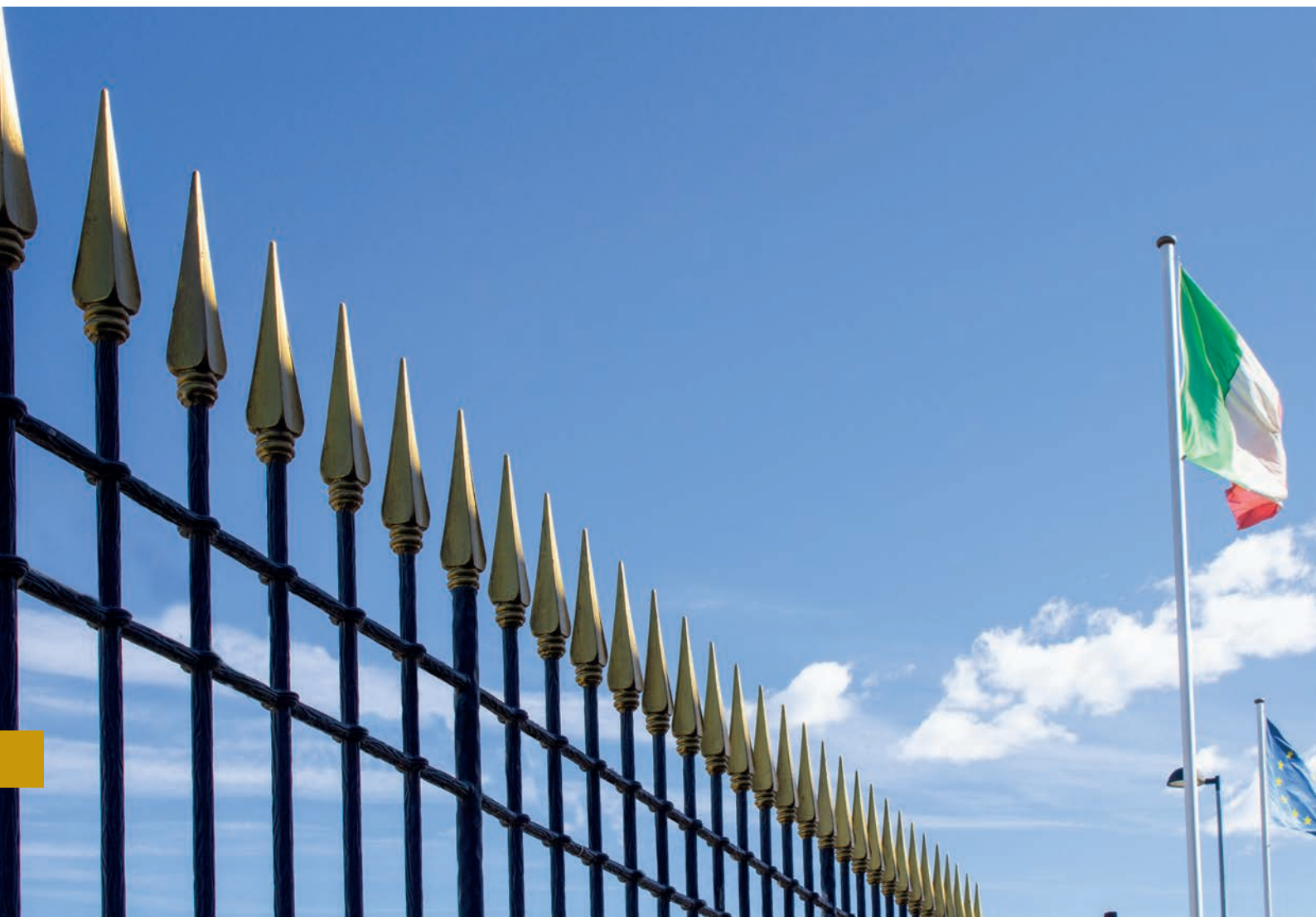



Art. 1466/2
Ø 50 x 72 mm
Filetto/Thread 14 MA



Art. 816/14
Ø 50 mm
Filetto/Thread 10 MA



Art. 1466/3
Ø 40 x 54 mm
Filetto/Thread 4 MA
Base Ø 33 mm



Art. 816/6
Ø 18 mm
Filetto/Thread 4 MA



Art. 160/43
Ø 80 x 130 mm
Filetto/Thread 12 MA
Base Ø 40 mm



Art. 160/44
Ø 96 x 93 mm
Filetto/Thread 12 MA
Base Ø 40 mm

Brass articles,
unless otherwise
specified, are
supplied raw

Gli articoli in ottone
se non diversamente
specificato, sono
forniti grezzi



Art. 160/45
Ø 56 x 117 mm
Filetto/Thread 12 MA
Base Ø 40 mm



Art. 160/46
Ø 78 x 55 mm
Filetto/Thread 12 MA
Base Ø 40 mm



Art. 816/3
Ø 80 x 120 mm
Filetto/Thread 6 MA
Base Ø 35 mm

Opaque Glass/Opaco



Art. 818/2
Ø 67 mm
Filetto/Thread 6 MA
Base Ø 28 mm





Art. 705/2
H 20 mm
Ø 46 mm
Filetto/Thread M3
□ 0,3 mm



Art. 707/6
12 x 140 mm
□ 0,3 mm



Art. 708/14
105 x 152 mm
□ 0,3 mm



Art. 793/5
115 x 230 mm
Hole/Foro
30 x 20 mm
2 shells - gusci



Art. 704/10
34 x 90 mm
□ 0,3 mm



Art. 709/12
72 x 72 mm
□ 0,3 mm



Art. 793/10
130 x 240 mm
Hole/Foro
20x15 mm
2 gusci / 2 shells



Art. 160/G/C
110 x 370 mm



Art. 160/G/D
250 x 360 mm
Half shell
Mezzo guscio



Art. 160/G/G
H 260 mm
L 220 mm
Mezzo guscio
Half shell



Art. 160/H/A
75 x 340 mm



Art. 160/H/C
75 x 135 mm



Art. 707/8
100 x 50 mm



Art. 160/H/N
Ø 97 mm
Half shell
Mezzo guscio



Art. 710/10
H 40 mm
Ø 100 mm
□ 0,3 mm



Art. 1463/1
Ø 115 mm
□ 4 mm



Art. 1463/5
Ø 105 mm
□ 4 mm



Art. 710/4
H 39 mm
Ø 100 mm
□ 0,3 mm



Art. 160/E/7
H 30 mm
Base 15 mm
Filetto/Thread 5 MA



Art. 160/E/8
Ø 35 mm
Filetto/Thread 5 MA

**Brass articles,
unless otherwise
specified, are
supplied raw**

**Gli articoli in ottone
se non diversamente
specificato, sono
forniti grezzi**



arteferro

arteferro
SYSTEM



H10



Display *Espositori e Display*

Showroom and
surroundings

Showroom e dintorni

arteferro



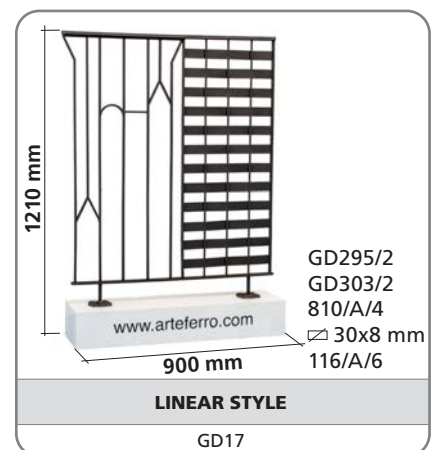
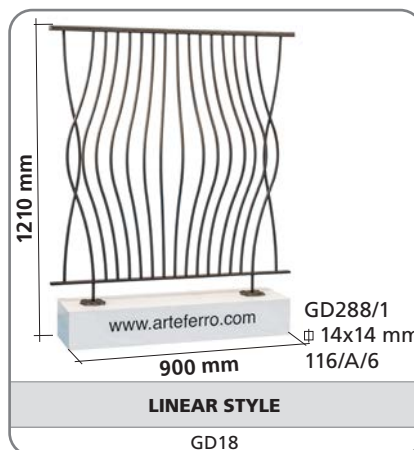
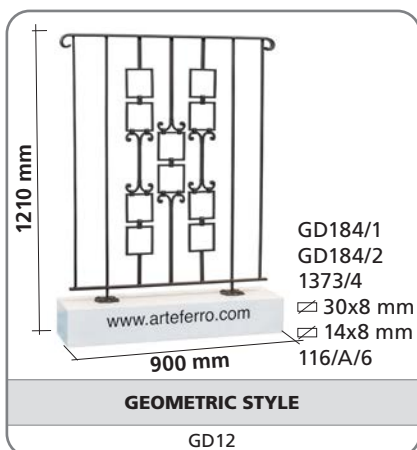
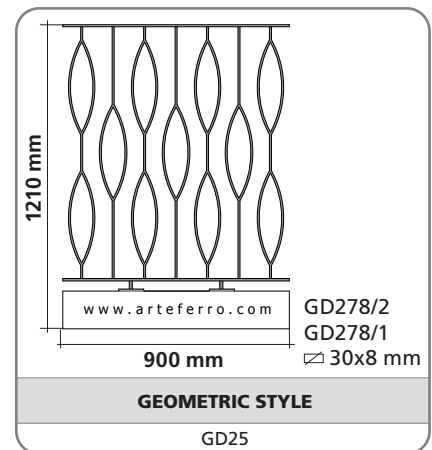
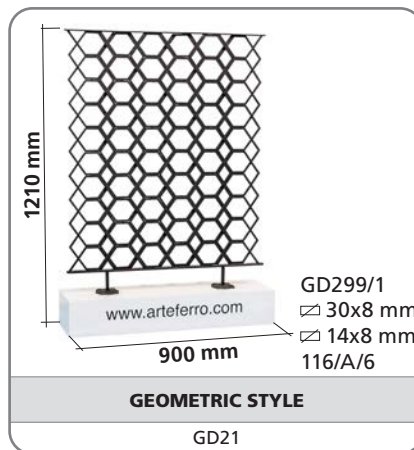
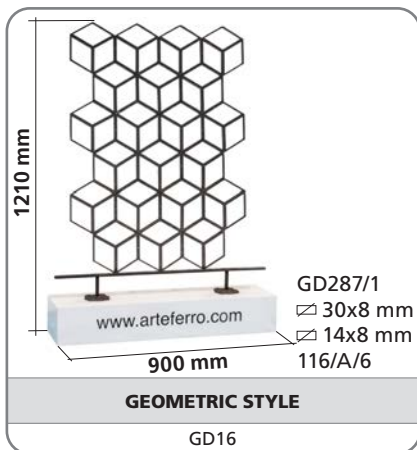
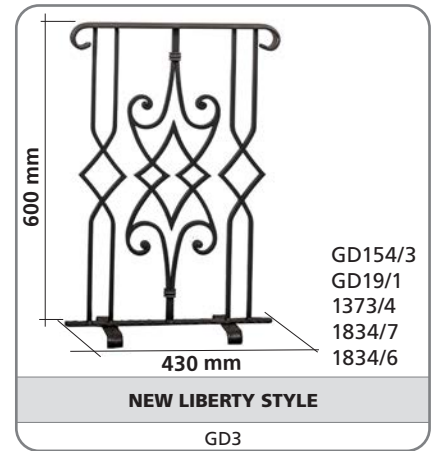
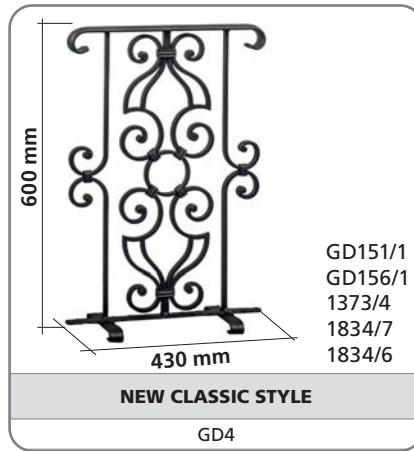
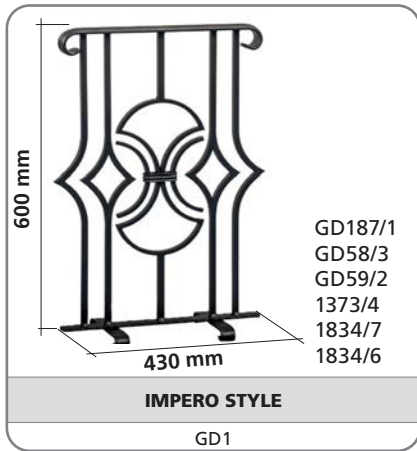
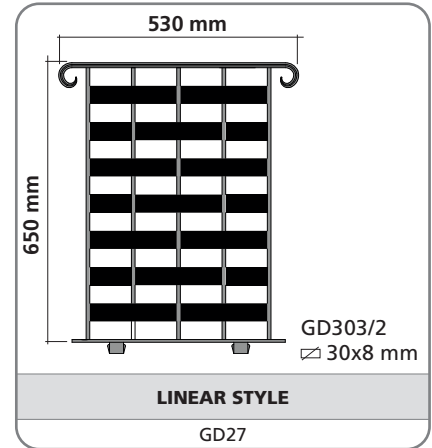
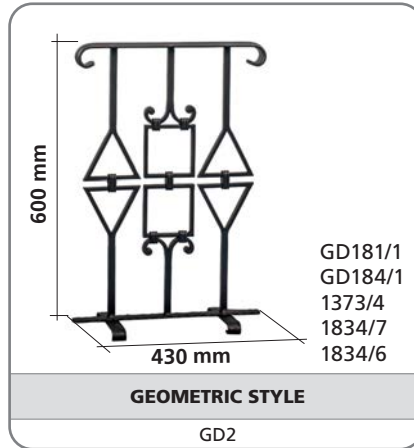
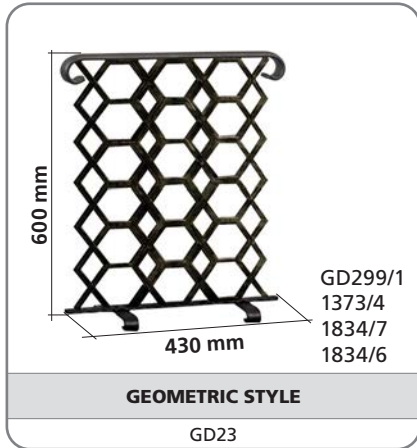

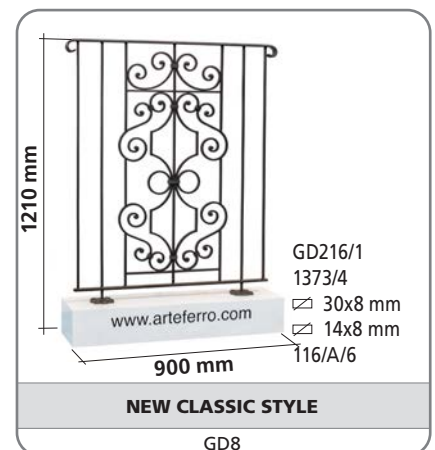
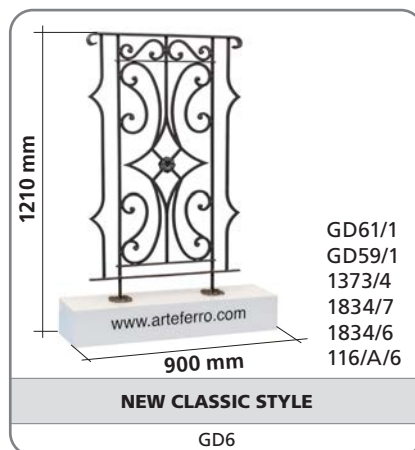
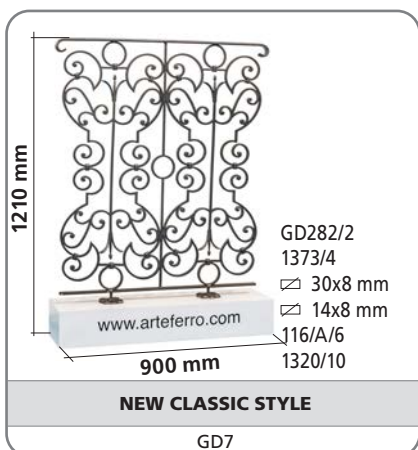
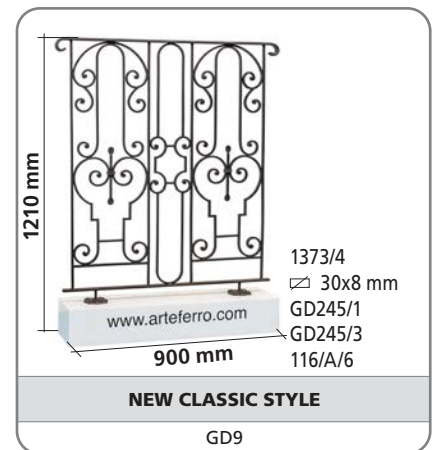
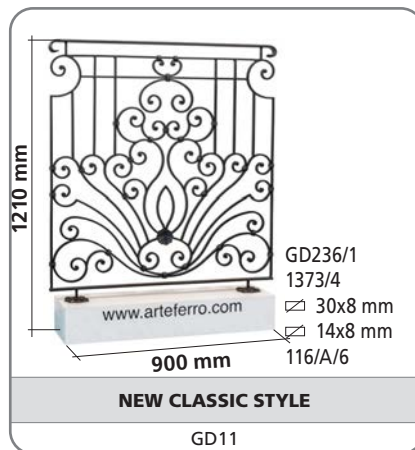
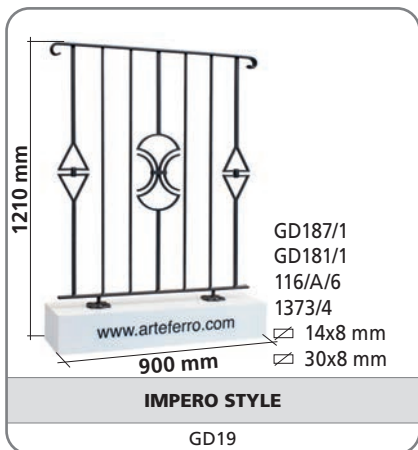
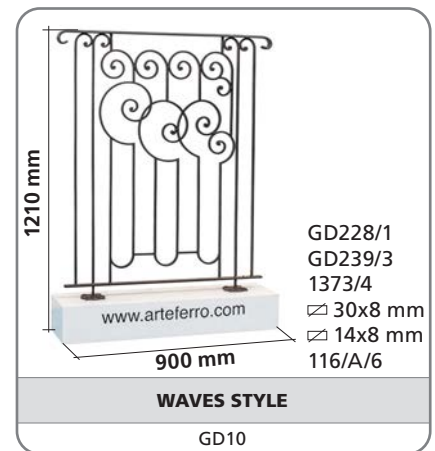
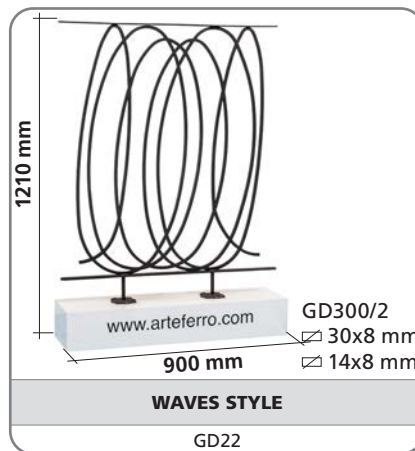
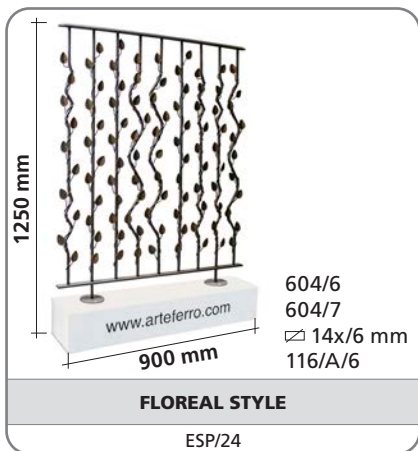
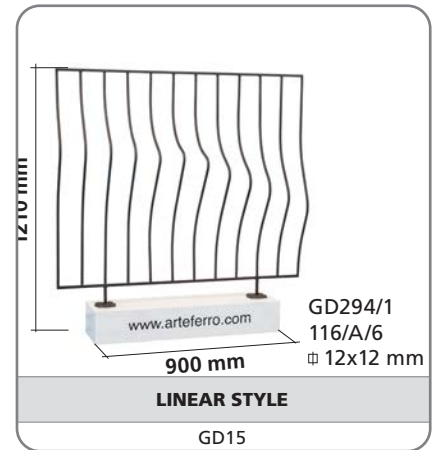
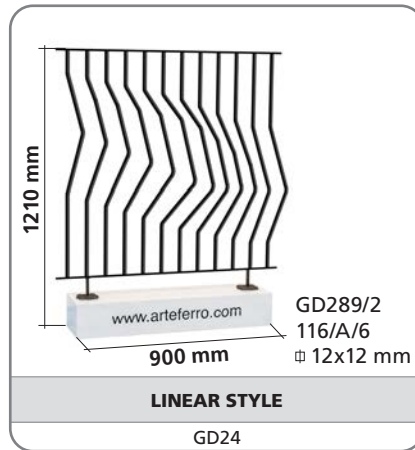
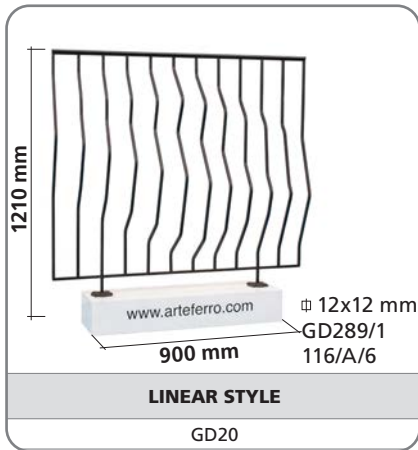

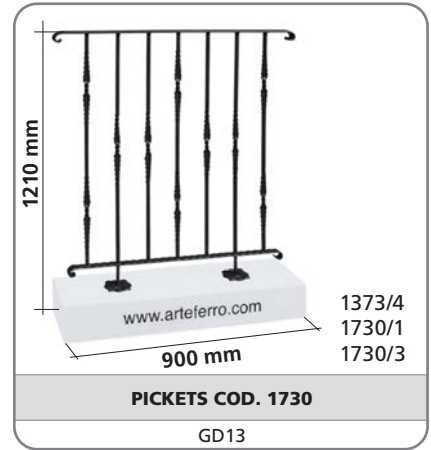
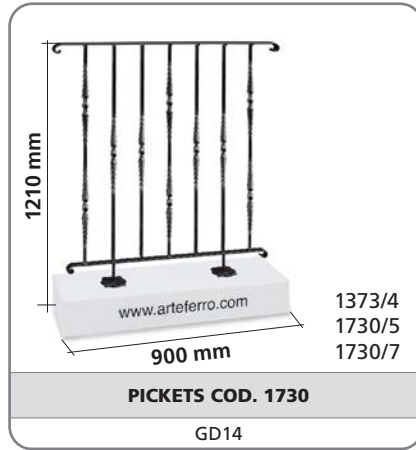
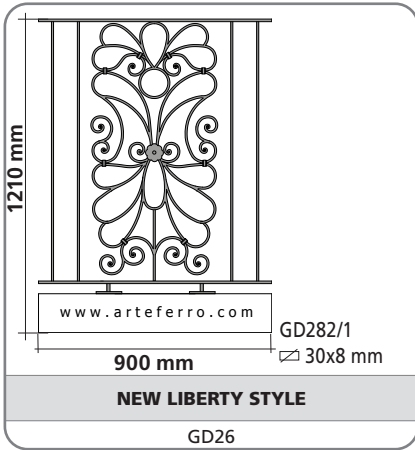

arteferro

OUR SERVICES
i nostri servizi



CUSTOMER SERVICE

SERVIZIO CLIENTI

The customers and their needs are always the focus of Arteferro attention.

The company provides real time updates on the stock and on the orders placed by our customers, offering also the possibility to **check the stocks and place orders online by the e-commerce website**.

The back-office staff speaks 5 different languages fluently and is qualified to handle export matters 48 hours delivery all over the world.

I clienti e le loro esigenze sono sempre al centro dell'attenzione di Arteferro.

*L'azienda fornisce in tempo reale aggiornamenti sullo stock e sugli ordini effettuati dai nostri clienti, offrendo anche la possibilità di **controllare le scorte e di effettuare ordini online dal sito e-commerce**.*

Il personale di back-office parla correntemente 5 lingue diverse ed è qualificato per gestire le esportazioni in massimo 48 ore in ogni parte del mondo.



arteferro.com

info@arteferro.com

+39 0445 580 580

from Monday to Friday
dal Lunedì al Venerdì
08.00 -18.00 (GMT+1)

ARTEFERRO LABORATORY

In its factory, Arteferro created a tests area, where all output is thoroughly tested. You can see below some of the tests we regularly perform. Our products have always been manufactured in order to reach the highest standards in quality and safety because we want to be sure that our systems are up to their function. To verify compliance with the specific functional and performance requirements, we carry in our test area a set of tests, measurements, investigations and inspections. Our products are qualitatively tested before, during and after production by qualified experts. Even more so, for 15 years we relied upon several certification authorities to certify our products, submitting them to several tests apt to determine in an objective way their performance. The design and production quality of Arteferro item allowed us to obtain certifications according to the standards currently in force in many European countries and to ensure the choice of our customers. Follow some test that we make every day.

Arteferro ha realizzato nei propri stabilimenti un'area appositamente dedicata ai test dei vari sistemi al fine collaudare rigorosamente tutta la produzione. Pertanto i nostri prodotti sono da sempre progettati e realizzati per offrire il massimo livello qualitativo e di sicurezza perché vogliamo essere certi che siano all'altezza della funzione che andranno a svolgere. Per verificare la rispondenza agli specifici requisiti funzionali e prestazionali, effettuiamo nella nostra Test Area un insieme di prove, misurazioni, accertamenti ed ispezioni. I nostri prodotti sono anche testati qualitativamente prima, durante e dopo la produzione da personale esperto e specializzato. Da ormai 15 anni ci affidiamo a più enti di certificazione che sottopongono i nostri prodotti a diverse prove atte a determinare, in modo oggettivo, le loro prestazioni. La qualità progettuale e produttiva degli elementi Arteferro ci ha permesso di ottenere certificazioni secondo le normative attualmente vigenti in molti paesi europei e di garantire così la scelta della nostra clientela. Di seguito, alcune delle prove che si effettuano regolarmente.

SOME OF THE TESTS CARRIED OUT – ALCUNI DEI TEST EFFETTUATI



STATIC TESTS PRE- AND POST-BREAKAGE
THESE TESTS ARE PERFORMED ACCORDING TO STRICT SAFETY STANDARDS, DEFINING THE CRITERIA AND STATIC, CONCENTRATED AND DISTRIBUTED LOADS, PRE- AND POST-BREAKAGE, OF RAILINGS, BALUSTRADES AND PREFABRICATED RAILINGS.

PROVE STATICHE PRE E POST ROTTURA
QUESTI TEST VENGONO ESEGUITI SECONDO RIGIDI STANDARD DI SICUREZZA, I QUALI DEFINISCONO I CRITERI ED I CARICHI STATICI, CONCENTRATI E DISTRIBUITI, PRE E POST ROTTURA, DI RINGHIERE, BALAUSTRATE E PARAPETTI PREFABBRICATI.



DYNAMIC TESTS
THESE TESTS ARE PERFORMED BY STRIKING SPECIFIC POINTS OF THE RAILING SYSTEMS WITH A MOVING OBJECT. THE ULTIMATE PURPOSE IS TO ASCERTAIN THE LEVEL OF SAFETY, EVEN IN CASE OF SUDDEN IMPACTS.

PROVE DINAMICHE
QUESTI TEST VENGONO ESEGUITI FACENDO IMPATTARE UN CORPO IN MOVIMENTO IN UN PUNTO SPECIFICO DEL SISTEMA PARAPETTO. IL FINE ULTIMO È QUELLO DI ACCERTARE IL LIVELLO DI SICUREZZA ANCHE IN CASO DI IMPATTI IMPROVVISI.

Our engineers are always up to date about the main european and international regulations
I nostri ingegneri sono sempre aggiornati in merito alle principali normative europee e internazionali

+39 0445 580 580 **info@arteferro.com**

arteferro



ENGINEERING SERVICE

If you need to develop a project and you require a complete guidance then Arteferro has the right tools for you.

Se hai un progetto da sviluppare e hai bisogno di una consulenza a 360 gradi, Arteferro ha gli strumenti adatti per te.

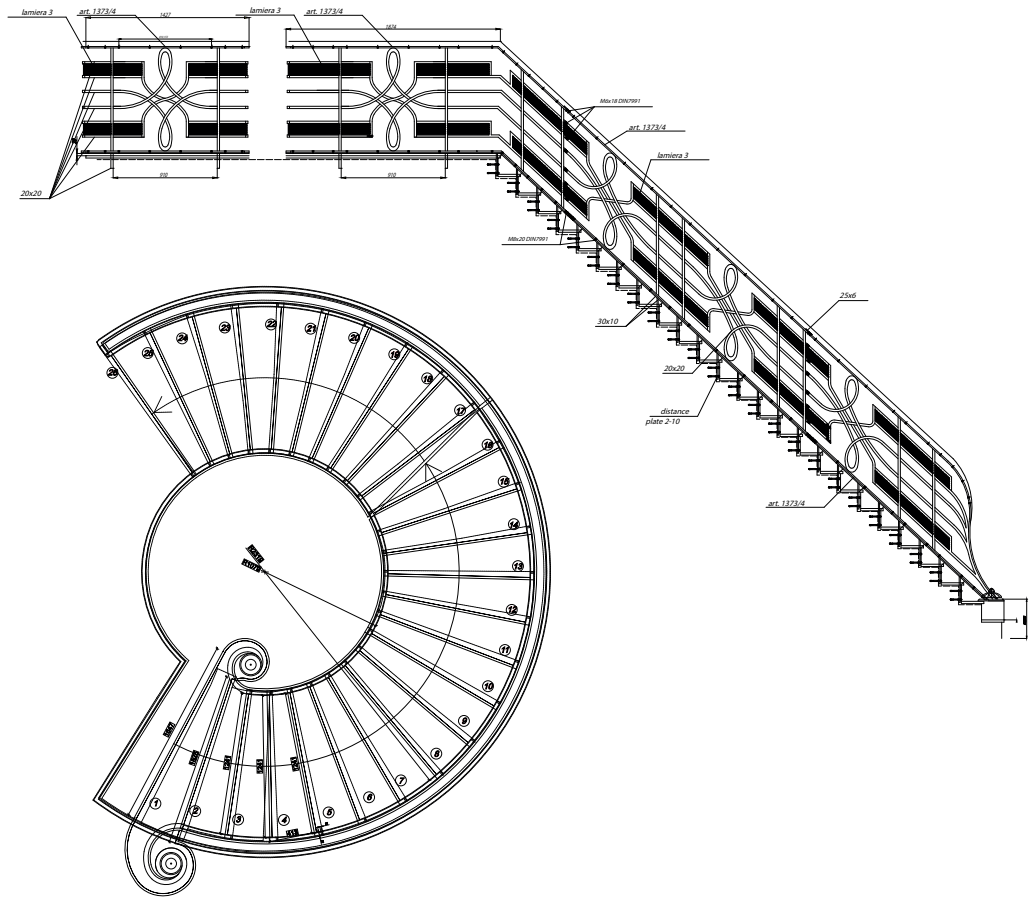

+39 0445 580 580

from Monday to Friday – dal Lunedì al Venerdì
08.00 - 18.00 (GMT+1)



Assistance and development

We give full assistance from the first step by submitting technical and aesthetical suggestions.

Assistenza e sviluppo

Supportiamo integralmente già nella prima fase con suggerimenti tecnico-estetici.



Estimates

We submit in short times detailed estimates with different proposals upon the selected planning options.

Preventivo

Forniamo in breve tempo un preventivo dettagliato con differenti soluzioni economiche a seconda delle opzioni progettuali scelte.



Engineering

We develop projects by listing all the necessary components needed.

Ingegnerizzazione

Sviluppiamo i progetti in dettaglio definendo la lista dei componenti necessari.



Structural dimensioning - Certification

Arteferro team gives the possibility of getting structural reports upon the national and international rules in force through LABORATORY TESTS in our TEST lab.

Dimensionamenti Strutturali-Certificazioni

Il team Arteferro fornisce la possibilità di avere relazioni strutturali secondo le norme vigenti nazionali ed internazionali con TEST SPERIMENTALI nel nostro laboratorio PROVE



arteferro.com

info@arteferro.com

TURNKEY PROJECTS

Arteferro in collaboration with Gonzato Group, that works on a project basis, is able to deliver products in stainless steel, wrought iron or any other metal, for prestigious private homes, public buildings, hotels, community spaces and for any kind of project, that requires a custom-made approach, from planning to installation. Assisting the customer throughout the process, from the first steps to the finished work, Gonzato Group is the ideal partner for any project and guarantee the client of the utmost quality of its products and its services.

PROGETTI CHIAVI IN MANO

Arteferro in collaborazione con Gonzato Group, lavora su progetto, è in grado di fornire prodotti in acciaio inox, ferro battuto o qualsiasi altro metallo, per prestigiose abitazioni private, edifici pubblici, hotel, spazi comunitari e per qualsiasi tipo di progetto, che richiedano un approccio su misura, dalla progettazione all'installazione. Affiancando il cliente durante tutto il processo, dai primi passi al lavoro finito, Gonzato Group è il partner ideale per qualsiasi progetto e garantisce al cliente la massima qualità dei suoi prodotti e dei suoi servizi.

CUSTOMIZABLE PERSONALIZZABILE AL 100%

All the staircases can be fully customized!
Choose your color, the shape and the material!

*Tutte le scale possono essere completamente personalizzate!
Scegli il colore, la forma e il materiale!*



ARTEFERRO BOOTCAMP

ARTEFERRO BOOTCAMP is born to transform and shape the skills of individual professionals and entire companies, by providing training and updating courses regarding construction principles, technologies, regulatory and safety aspects related to ARTEFERRO products.

ARTEFERRO BOOTCAMP nasce allo scopo di trasformare e plasmare le competenze di singoli professionisti ed intere aziende, erogando corsi di formazione e aggiornamento inerenti i principi costruttivi, le tecnologie, gli aspetti normativi e di sicurezza legati ai prodotti ARTEFERRO.



Do you need training for yourself and for your sales force?
Contact us and we will arrange for you a proper BOOTCAMP TRAINING online or at your premises!

*Hai bisogno di formazione per te e per la tua forza vendite?
Chiamaci e organizzeremo un vero e proprio BOOTCAMP DI FORMAZIONE online o presso la tua sede!*

info@arteferro.com

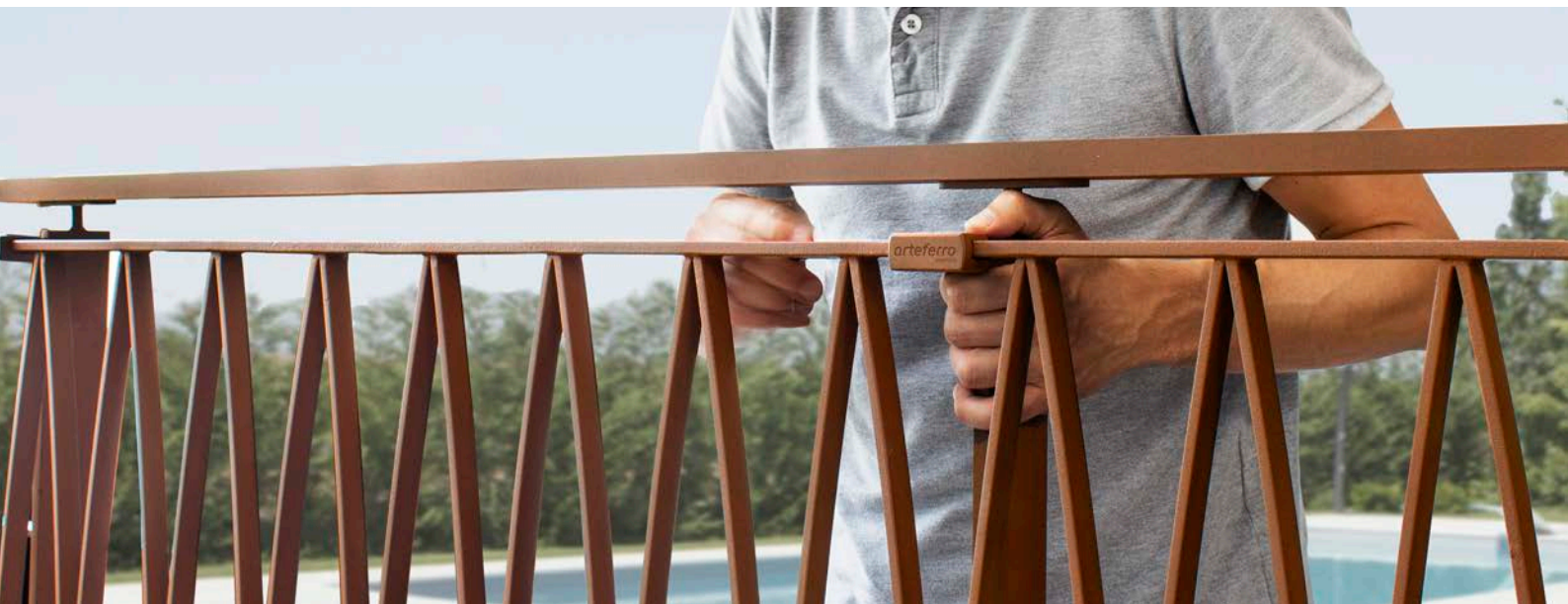

MATERIALS AND FINISHING

MATERIALI E FINITURE

AISI304



AISI 304 STAINLESS STEEL - SATIN FINISH

AISI 304 is a stainless steel austenitic alloy composed by a Cr content between 18% and 20% and a Ni content between 8% and 11%. It is the most utilized stainless steel in the world, and represents more than 50% of the total consumption. The ideal steel for indoor installation.

ACCIAIO AISI 304 - SATINATO

L'AISI 304 è una lega di acciaio inox austenitica composta da un tenore di Cr tra il 18% ed il 20% e di Ni tra l'8% e l'11%. È il tipo di acciaio inossidabile più utilizzato al mondo e costituisce più del 50% del consumo totale di inox. L'acciaio ideale per installazioni in interni.

AISI316



AISI 316 STAINLESS STEEL - SATIN FINISH

AISI 316 is a stainless steel austenitic alloy composed by a Cr content between 16% and 18%, a Ni content between 11% and 14% and a Mo content between 2% and 3%. Molybdenum percentage guarantees a better corrosion resistance, therefore it is the ideal material for outdoor installation.

In case of strong external environments, AISI316 mirror finish is recommended, because it proves to be really resistant in terms of atmospheric agents, pollution and seaside chlorides.

ACCIAIO AISI 316 - SATINATO

L'AISI 316 è una lega di acciaio inox austenitica composta da un tenore di Cr tra il 16% ed il 18%, di Ni tra l'11% e il 14% e di Mo tra il 2% ed il 3%. La percentuale di molibdeno assicura una migliore resistenza alla corrosione, pertanto è il materiale ideale per installazioni in esterni.

In caso di installazione in ambienti esterni aggressivi, si raccomanda la scelta di acciaio AISI 316 con finitura mirror in quanto particolarmente resistente agli agenti atmosferici, all'inquinamento e ai cloruri tipici delle località marittime.

AISI316
MIRROR



AISI 316 STAINLESS STEEL - MIRROR

Mirror finish is obtained mechanically thanks to specific abrasive brushes that polish the surface increasing corrosion resistance. Upon several tests effected with the collaboration of the main research institutes of research, Arterferro recommends the use of mirror polished products for application in saline environments (area within 12 km from the seaside) or in areas with high level of polluting agents (city centres/industrial areas).

ACCIAIO AISI 316 - LUCIDO

La finitura Mirror è ottenuta meccanicamente con l'utilizzo di speciali spazzole abrasive che lucidano la superficie degli elementi aumentandone la resistenza alla corrosione. Dopo numerose prove svolte in collaborazione con i principali istituti di ricerca, Arterferro consiglia l'utilizzo dei prodotti lucidati a specchio per applicazioni in ambiente salino (fino a 12 km dal mare) o ad alta concentrazione di agenti inquinanti (centro città/zone industriali).

IRON



GALVANIZED IRON

It is Fe360B galvanized iron. Unlike stainless steel, iron is cheaper but more subject to corrosion. To solve this problem, it is hot dip galvanized. Perfect for outdoor installations.

FERRO ZINCATO

Si tratta di ferro Fe360B zincato. Il ferro, rispetto all'acciaio inox, è più economico ma è anche molto più soggetto alla corrosione. Per ovviare a questa problematica viene zincato a caldo. E' una soluzione ideale per installazioni in esterni.

ALU



ALUMINIUM

The Aluminium used in Arterferro items is anodized and brushed. The chemical treatment called anodization is able to convert the material surface, making it more resistant and longer lasting in terms of oxidation. Brushing is a finish that gives the profile a specific scratching, as the one of the satin stainless steel. It is a cheap solution, suitable for both indoor and outdoor installations.

ALLUMINIO

L'alluminio utilizzato per gli elementi Arterferro è anodizzato e spazzolato. Il procedimento chimico chiamato anodizzazione è in grado di trasformare la parte superficiale del materiale trattato, rendendola più resistente e durevole nei confronti dei processi di ossidazione. La spazzolatura è una finitura che conferisce al profilato una speciale graffiatura, simile a quella dell'acciaio inox satinato. E' una soluzione economica, valida per installazioni sia in interni sia in esterni.



ECO-FRIENDLY - 100% RECYCLABLE

The Arterferro steel elements are 100% recyclable: they can be remelt to produce new objects.

ECO-FRIENDLY - 100% RICICLABILE

Gli elementi in acciaio Arterferro sono riciclabili al 100%: possono quindi essere rifusi per produrre nuovi oggetti.

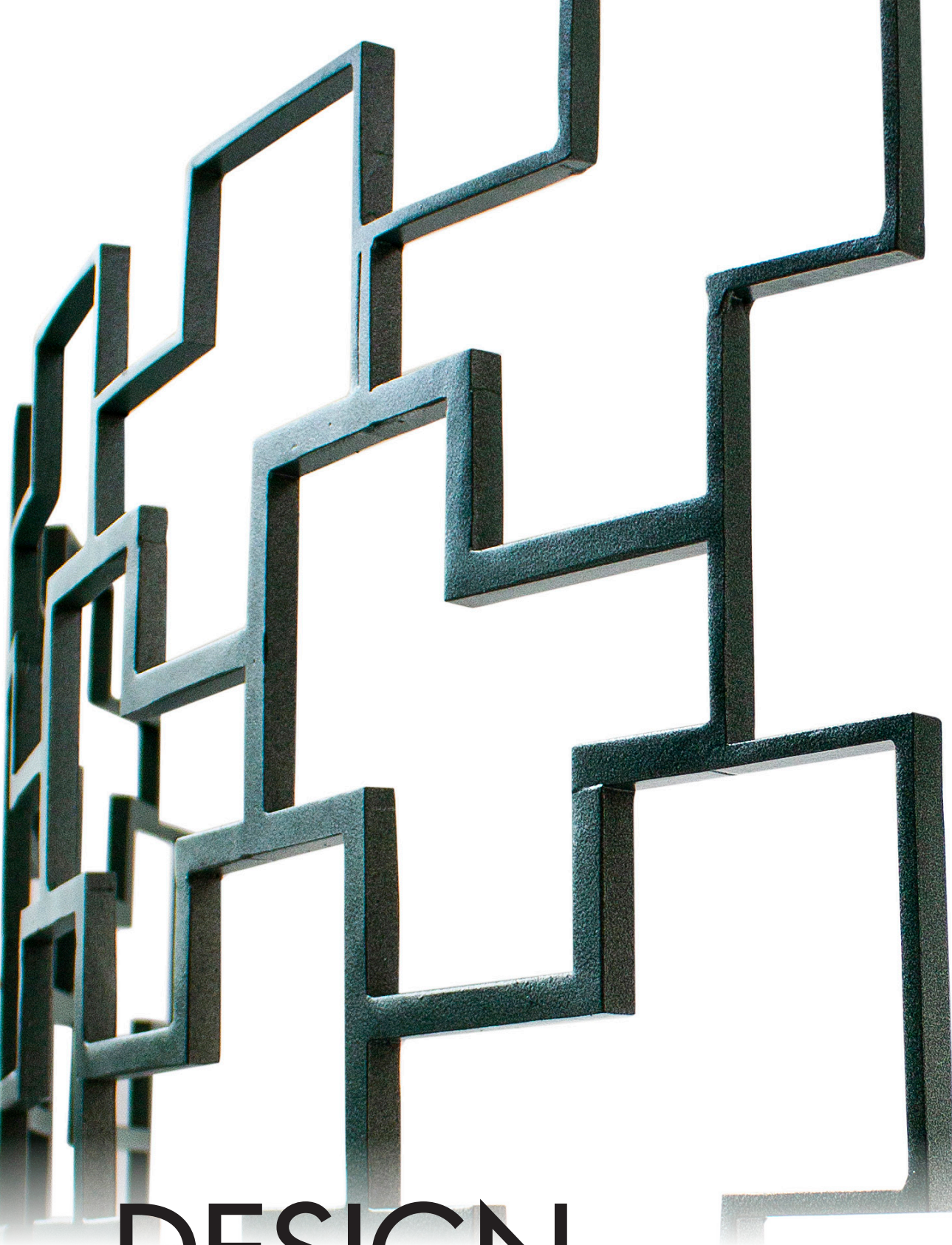

DESIGN

Arteferro products are ideal for those who want a railing original and with unique design. To complete the work, just only your imagination is needed.

I prodotti Arteferro sono l'ideale per chi desidera un parapetto originale, e dal design unico. Per completare l'opera, basterà solo la tua fantasia.

+39 0445 580 580

info@arteferro.com

CULTURE PRODUCT

Arteferro deals with real experiences to enhance product culture and share it for the development of new project ideas. The themes of technological innovation, sustainability and aesthetic are the founding elements of the research set with universities and training events organized with architect studios and retailers worldwide. Arteferro works both with and for designers, so that their ideas are given free reign and their designs realized. The specification of the construction site is an opportunity for project design and culture of product to meet. This enables a reduction in time and cost of construction, which in turn creates excellent results.

CULTURA DI PRODOTTO

Arteferro si confronta quotidianamente con esperienze reali per fare cultura di prodotto e sviluppare nuove consapevoli idee progettuali. Le tematiche di innovazione tecnologica, sostenibilità e ricerca estetica sono alla base dello studio con le università e degli eventi di formazione organizzati con studi di architettura e rivenditori di tutto il mondo. Arteferro lavora sia con che per i designer, in modo che le loro idee diventino realtà nei progetti realizzati. Le peculiarità del cantiere sono un'opportunità di incontro tra design del progetto e cultura del prodotto. Ciò consente una riduzione dei tempi e dei costi di costruzione, che a sua volta crea ottimi risultati.

IDENTITY

From the studying of the product till the realization of the packaging Arteferro distinguishes itself for quality, professionalism and functionality.

Dallo studio del prodotto alla realizzazione dell'imballaggio, Arteferro si distingue per qualità, professionalità e funzionalità.

+39 0445 580 580
info@arteferro.com

17/11 11:00



VERTICAL METALS

It's called Vertical Metals and is the new line for ornamental façades systems branded Arterferro. Patented design, green material, it can be a siding but also a stand-alone structure or a partial/total coverage. From the eras of Romanticism and Art Nouveau this is the first conceptual reworking of a classic material like wrought iron that, also maintaining the typical craftmade finishing, takes on a completely new design characterized by unusual tridimensionality.

Si chiama Vertical Metals ed è la nuova linea di sistemi per facciate ornamentali marchiate Arterferro. Design brevettato, materiale green, può essere un rivestimento ma anche una struttura a sé stante, a copertura parziale o totale. Dalle epoche del Romanticismo e dell'Art Nouveau è la prima rielaborazione concettuale dell'utilizzo di un materiale classico come il ferro battuto che, pur mantenendo la tipica finitura artigianale, assume un design completamente nuovo dalle insolite tridimensionalità.



RESEARCH AND DEVELOPMENT

In Arteferro the designers and engineers team daily works to design new products in harmony with current technical requirements so that they are easy to install and integrate with other architectural elements. Research is continuously ongoing, especially in terms of manufacturing and combinations, such as wood and glass, which characterize products even more and more and satisfy specific aesthetic requests.

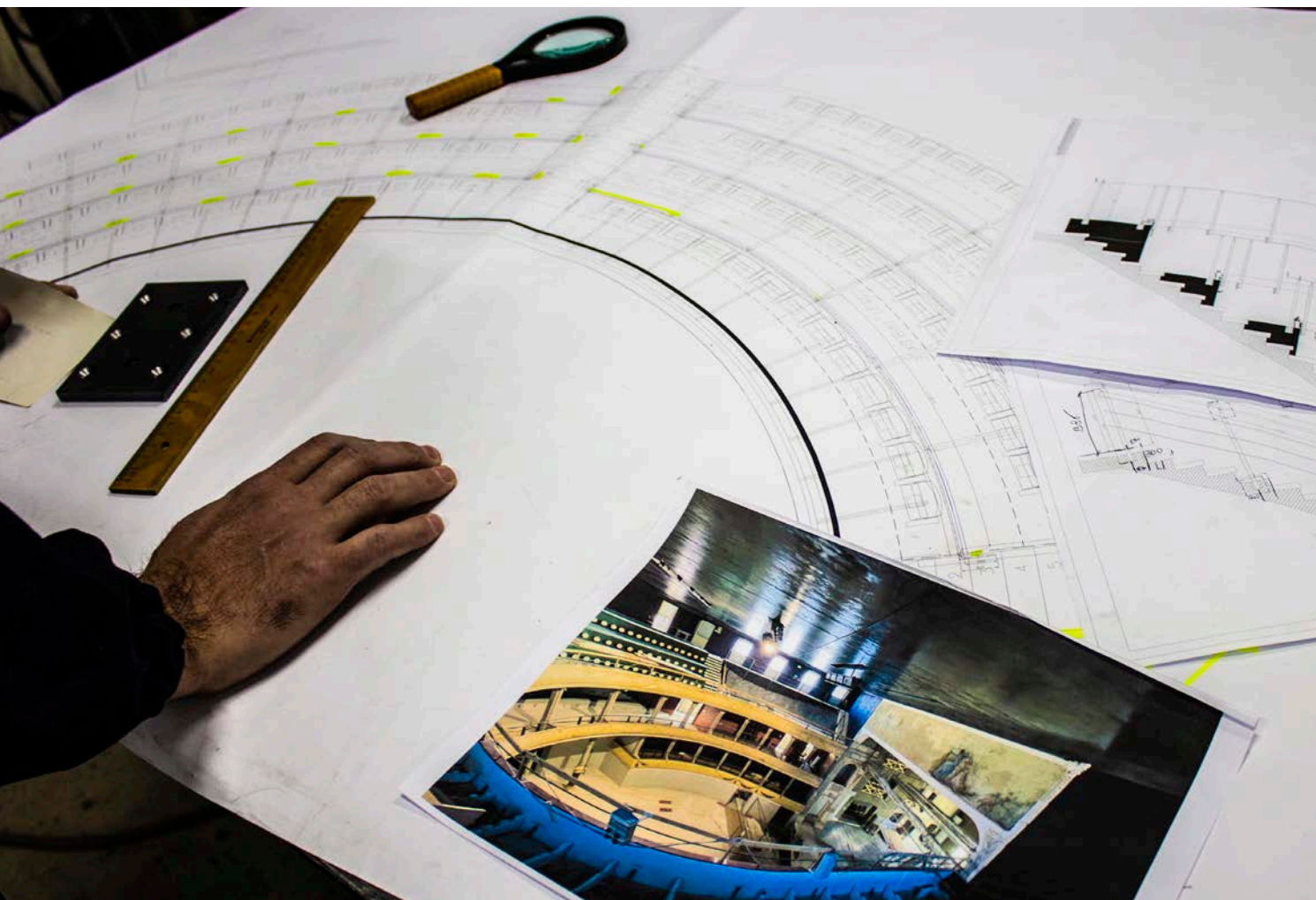

RICERCA E SVILUPPO

In Arteferro un team di designer ed ingegneri lavora quotidianamente all'ideazione di nuovi prodotti che soddisfino sempre più la necessità di bellezza, in armonia con le esigenze tecniche oggi esistenti, che siano facili da installare e da integrare con gli altri elementi architettonici, adattandosi all'ambiente. Costante è la ricerca di lavorazioni ed abbinamenti con materiali diversi, come ad esempio il legno ed il vetro, che caratterizzano ancora di più i prodotti e che soddisfano così anche le richieste estetiche più particolari.

TECHNICAL SUPPORT

SUPPORTO TECNICO

The company supports clients and users with training sessions held by qualified experts. A team of architects, engineers and qualified experts is at the disposal of the customers to provide them with products information and explanations on their uses and applications.

L'azienda supporta i clienti e gli utenti con sessioni di formazione tenute da esperti qualificati. Un team di architetti, ingegneri ed esperti qualificati è a disposizione dei clienti per fornire loro informazioni sui prodotti e spiegazioni sui loro utilizzi e sulle applicazioni.

Do you need technical SUPPORT from our office? Do not hesitate to call or write us
Necessiti di un aiuto tecnico da parte del nostro ufficio? Non esitare a chiamarci o scriverci

+39 0445 580 580 info@arteferro.com

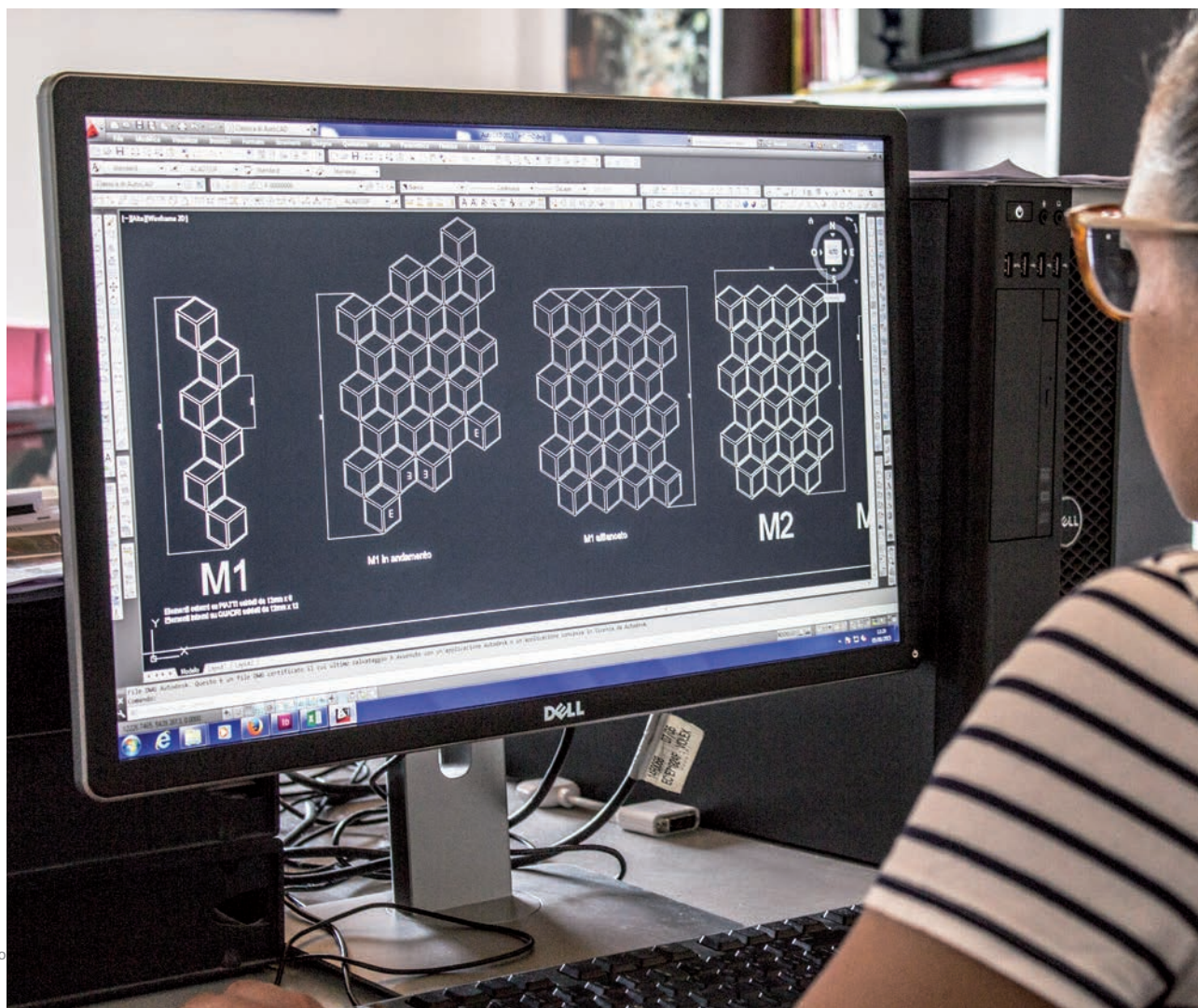



WAIT!
That's not all

If you can't find what you need,
we can make it especially for you!

ASPETTA!
Non è tutto.

*Se non trovi quello che cerchi,
possiamo realizzarlo apposta per te!*

+39 0445 580 580
info@arteferro.com

arteferro

CATALOGUES,
TOOLS AND
MUCH MORE
OUR PLUS

*cataloghi, strumenti
e molto altro
i nostri plus*



arteferro.com/catalogs

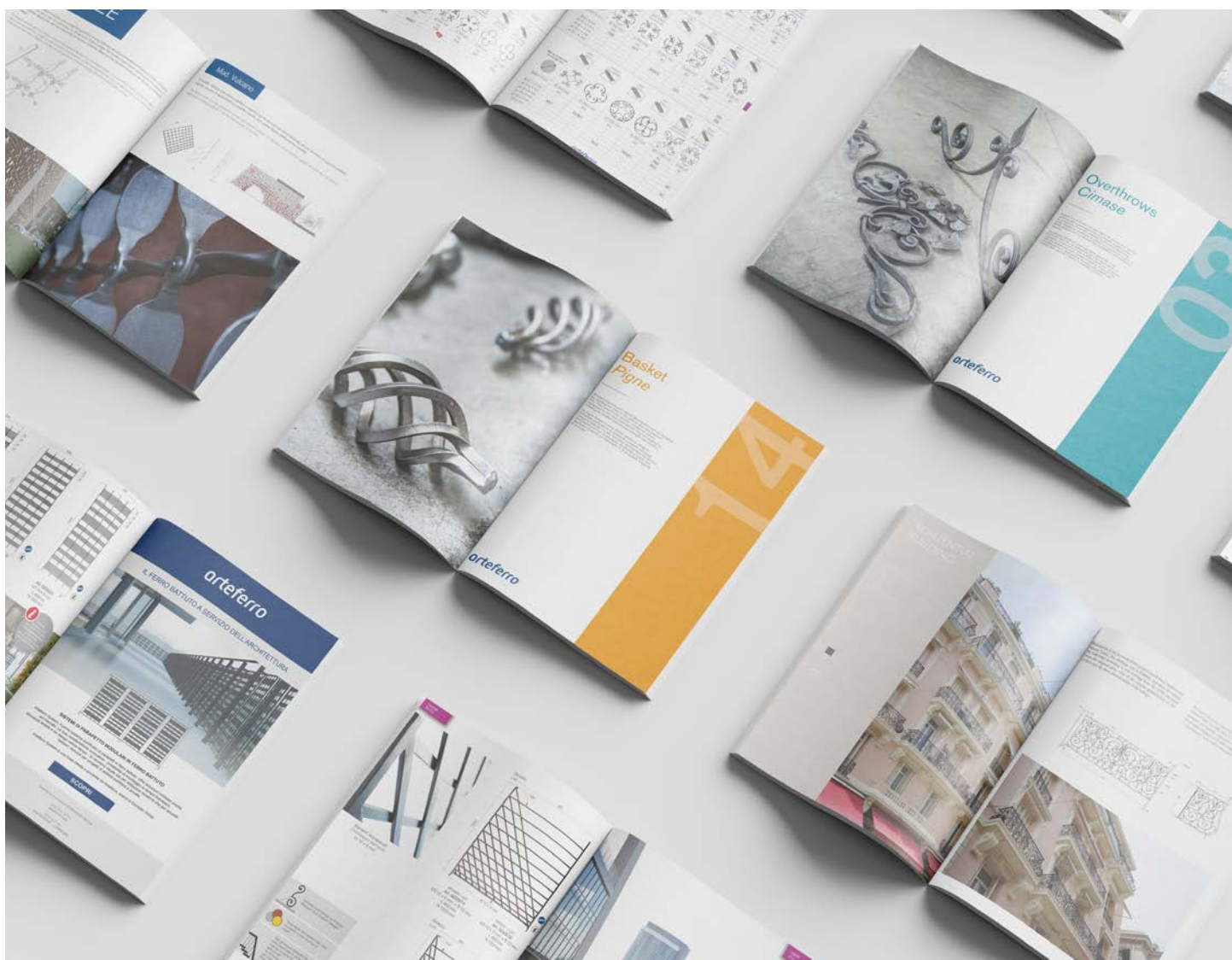

The catalogs, to discover and share the Arteferro world: collections, products, expert suggestions and achievements.

I cataloghi, per scoprire e condividere il mondo Arteferro: le collezioni, i prodotti, i suggerimenti di esperti e le realizzazioni.



IDEA!!!

You can easily download the pdf of our catalogues on your phone or tablet and share it with your contacts via WhatsApp, e-mail or social media

Puoi facilmente scaricare i pdf dei nostri cataloghi sul tuo cellulare o tablet e condividerlo con i tuoi contatti tramite WhatsApp, e-mail o social media



DOWNLOAD ARTEFERRO SYSTEM



User:
Architects - Architetti
Showroom,
Artisans - Artigiani

ARTEFERRO SYSTEM

Arteferro System, totally revolutionizes the concept of iron railing. Perfectly suitable for the branches of private, public construction, fully customizable in the design loads 1 kN and 2kN, thanks to the certified newel posts.

Arteferro System, rivoluziona totalmente il concetto di parapetto in ferro. Perfettamente idoneo per i rami dell'edilizia privata, pubblica, totalmente personalizzabile nei carichi di spinta 1 kN e 2kN, grazie al montante certificato.



COMPENDIUM



User:
Artisans - Artigiani
Distributors - Distributori

COMPENDIUM

The Arteferro general catalogue provides a quick but detailed overview of over 3,000 products of the Arteferro line thanks to new graphics, updated content and new insights. This new version of the catalogue concentrates the know-how and expertise of our designers.

Il Catalogo generale di Arteferro fornisce una rapida ma dettagliata panoramica degli oltre 3.000 prodotti della linea Arteferro grazie alle nuove grafiche, ai contenuti aggiornati e ai nuovi approfondimenti. In questa nuova versione del catalogo è concentrato il know-how e la competenza dei nostri designer.



DOWNLOAD VERTICAL METALS



User:
Architects - Architetti

VERTICAL METALS

It's called Vertical Metals and is the new line for ornamental façades systems branded Arteferro. Patented design, green material, it can be a siding but also a stand-alone structure or a partial/total coverage.

Si chiama Vertical Metals ed è la nuova linea di sistemi per facciate ornamentali marchiate Arteferro. Design brevettato, materiale green, può essere un rivestimento ma anche una struttura a sé stante, a copertura parziale o totale.



VIDEO TUTORIALS



Because assembling our components is a piece of cake!
The overview of the assembly tutorials of our line arteferro, suitable for any kind of project, is available in the video section of our web site and in our official Youtube channel.

*Perché montare i nostri componenti è un gioco da ragazzi!
Sul nostro sito web, alla sezione video, e sul nostro canale Youtube ufficiale è disponibile la panoramica dei tutorial di montaggio della linea arteferro.*



You
Tube



IDEA!!!

Subscribe to our official Youtube channel, to stay always up-to-date on Arteferro installation videos and more!

Iscriviti al nostro canale ufficiale Youtube per rimanere sempre aggiornato sui video di installazione Arteferro e non solo!

NETSALES B2B.gonzato.com

The new B2B service dedicated to our most loyal customers.

If you want to activate and get the credentials to access the B2B portal, write a request email to the following address: netsales@arteferro.com

Il nuovo servizio B2B dedicato ai clienti più affezionati.

Se vuoi attivare e ottenere le credenziali di accesso al portale B2B, scrivi una mail di richiesta al seguente indirizzo: netsales@arteferro.com

h24/7days



RESERVED

Reserved Area for
your purchases

*Area Riservata
per i vostri acquisti*



Download and print
all the documents you need

*Scarica e stampa
tutti i documenti
che ti servono*



Check the stock of our
warehouse in a real time

*Controlla lo stock
del nostro magazzino
in tempo reale*



If you want to activate and get the credentials to access the B2B portal, send a request email to the following address: netsales@arteferro.com

Se vuoi attivare e ottenere le credenziali di accesso al portale B2B, scrivi una mail di richiesta al seguente indirizzo: netsales@arteferro.com



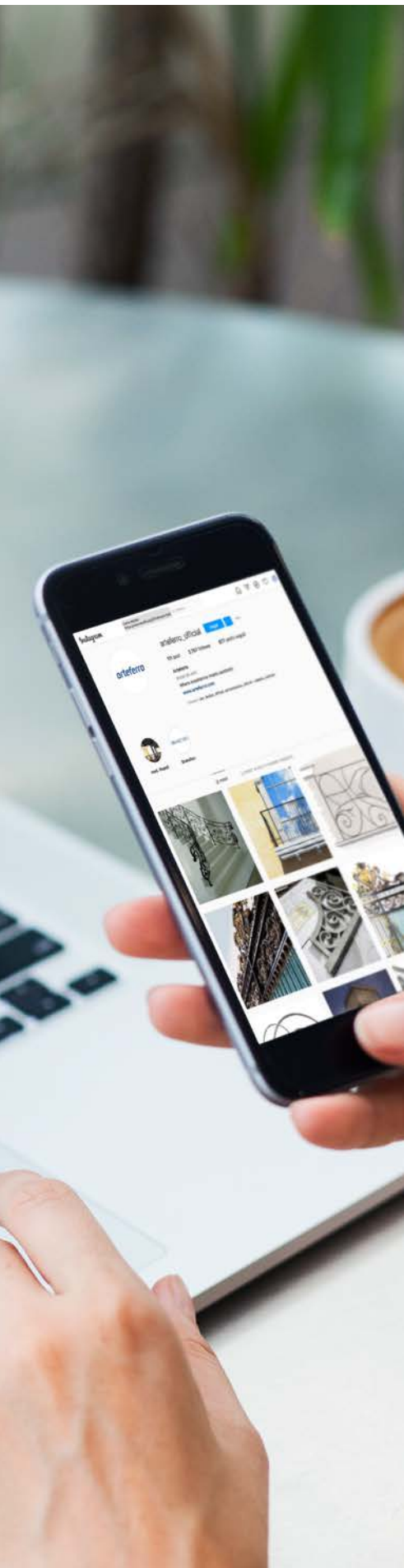

FOLLOW US

Share our photos on social media and create with us the
ARTEFERRO COMMUNITY.

*Condividi le nostre foto sui Social e crea con noi
la COMMUNITY ARTEFERRO.*

instagram



facebook



Tag us on the photos of your projects,
we will repost in our official channels.

*Taggaci sulle foto dei tuoi progetti realizzati, ripubblicheremo
nei nostri canali i migliori*

linkedin



Stay up to date on products
and on the training courses of Arteferro BOOTCAMP

*Rimani aggiornato sui prodotti
e sui corsi di formazione dell'Academy Arteferro*

youtube



Discover our video tutorials
and how easy it is to assemble Arteferro products

*Scopri i nostri video tutorial e quanto è
facile montare i prodotti Arteferro*

PRODUCT INDEX IN ALPHANUMERIC ORDER - INDICE PRODOTTI IN ORDINE ALFANUMERICO

17/1	265	42/A/6	47	48/11	126	64/H/14	226
17/2	264	42/A/6/Z	391	48/12	126	64/H/15	226
18/1	265	42/A/7	47	48/13	126	64/H/16	226
18/2	265	42/A/8	47	48/14	126	64/H/17	226
18/A/1	265	42/A/9	47	49/1	132	64/H/18	226
20/1	265	42/A/10	47	49/2	150	64/H/19	225
21/4	264	42/A/11	47	49/3	121	64/H/20	225
21/5	266	42/A/12	47	49/4	132	64/I/1	109
22/1	264	42/A/13	47	49/5	121	64/I/3	109
22/2	264	42/A/14	47	49/7	121	64/I/4	109
22/B/1	265	42/A/15	47	50/5	106	64/L/1	98
22/B/3	265	42/A/15/S	47	50/6	106	64/L/3	98
23/1	265	42/A/16	47	50/7	106	64/L/4	98
23/2	265	42/A/16/SP3	47	50/8	106	65/1	153
23/2	265	42/A/17	47	50/9	106	65/7	116
24/B/1	268	42/A/18	47	50/10	106	65/8	116
24/C/1	267	42/B/4/S16	56	50/11	106	66/5	122
24/C/3	268	42/B/4/S17	56	50/12	106	66/7	122
24/E/1	269	42/B/5	235	50/13	106	68/2	152
24/F/1	144	42/B/6	235	50/14	106	70/A/3	132
24/F/2	296	42/B/7	235	50/15	106	70/B/3	132
26/1	265	42/B/8	235	51/1	121	70/B/5	132
26/2	265	42/10	47	51/3	151	70/D/1	136
26/4	265	42/10/Z	391	51/4	121	70/D/3	116
26/5	265	42/11	47	51/6	151	70/D/4	223
26/B/1	271	42/11/Z	391	52/1	145	70/D/5	223
26/B/2	271	42/12	47	52/2	123	70/D/9	223
26/C/1	270	42/13	47	52/A/2	120	70/E/2	153
27/4	266	42/14	47	52/A/3	120	70/E/7	153
30/2	265	42/15	47	52/A/4	149	71/1	300
30/4	264	42/16	47	52/A/5	120	71/3	300
30/7	264	42/17	47	52/E/1	149	72/4	300
31/3	264	42/18	47	52/E/2	151	73/1	290
33/1	265	42/19	47	52/E/3	123	73/2	290
33/2	265	42/20	47	52/E/4	121	73/3	290
33/3	265	42/21	47	52/E/5	147	74/2	278
34/1	270	42/22	47	52/F/1	120	74/3	278
34/3	369	42/23	47	52/G/1	147	74/4	278
35/1	306	42/24	47	52/H/3	274	74/5	278
35/2	306	42/25	47	53/1	121	74/6	278
36/1	306	42/26	47	53/3	116	74/7	278
36/2	306	42/27	47	55/5	121	74/8	278
37/1	306	42/28	47	55/6	121	74/9	278
37/2	306	44/6	256	56/1	131	74/10	278
37/3	306	44/7	256	56/3	121	74/11	278
38/1	61	44/12	230	56/4	121	74/12	278
38/2	61	44/14	230	56/6	131	74/13	278
38/3	61	45/19	230	58/1	152	74/14	278
38/4	61	45/21	230	59/1	152	74/15	278
38/8	290	46/1	228	59/3	152	74/16	278
39/2	60	46/3	229	59/8	152	74/17	278
40/1	61	46/5	229	60/2	122	74/18	278
40/2	61	46/6	229	60/3	134	74/19	278
40/3	61	46/8	228	61/3	138	74/20	278
40/4	61	46/10	228	62/1	144	74/21	278
40/5	61	46/11	228	62/2	144	74/22	278
40/A/1	61	46/12	228	63/2	144	74/23	278
40/A/1/S	61	47/1	226	63/3	144	74/24	278
40/A/2	61	47/3	219	63/4	144	74/25	278
40/A/3	61	47/3/1000	219	64/2	152	74/26	278
40/B/6	60	47/4	226	64/A/1	134	74/27	278
40/B/7	60	47/5	219	64/A/2	134	74/28	278
40/B/10	60	47/6	219	64/A/4	134	75/31	292
40/B/12	338	47/9	219	64/A/6	134	75/32	292
41/1/C	362	47/10	226	64/B/1	134	75/33	292
41/2	60	47/11	219	64/B/2	119	76/1	292
41/4/C	362	47/12	219	64/B/3	153	76/2	292
41/5/C	362	47/13	219	64/B/4	134	76/3	292
41/6/C	362	47/14	219	64/B/5	119	78/1	278
41/8/C	362	47/15	219	64/D/1	226	78/2	278
41/10/C	362	47/16	219	64/D/3	225	78/3	278
41/11/C	362	47/17	219	64/D/4	225	78/4	278
41/12/C	362	47/21	227	64/D/5	225	78/5	278
41/13/C	362	47/26	219	64/D/7	225	78/7	278
41/14/C	362	47/28	219	64/D/9	225	78/8	278
41/15/C	362	47/30	219	64/D/10	225	78/9	278
41/16/C	362	47/33	219	64/E/3	119	78/B/1	287
41/17/C	362	47/34	219	64/E/4	284	78/B/2	287
41/18/C	362	47/34/Z	395	64/E/6	284	78/B/3	287
41/19/C	362	48/1	126	64/F/1	102	78/B/5	287
41/20/C	362	48/2	126	64/F/2	102	78/B/6	287
41/21/C	362	48/3	126	64/F/3	102	78/B/11	300
41/22/C	362	48/4	126	64/F/4	102	78/10	278
42/1	46	48/5	126	64/F/5	102	78/11	278
42/1/Z	391	48/6	126	64/F/6	102	78/12	278
42/2	46	48/7	126	64/F/7	102	78/13	278
42/2/Z	391	48/8	126	64/F/8	102	78/14	278
42/3	46	48/9	126	64/F/9	102	78/15	289
42/3/Z	391	48/A/1	126	64/G/1	102	79/7	298
42/4	46	48/A/2	126	64/G/2	102	80/A/1	280
42/4/Z	391	48/A/4	126	64/G/3	288	80/A/2	280
42/5	46	48/A/5	126	64/G/4	288	80/A/3	280
42/6	46	48/A/6	126	64/G/5	288	80/A/4	280
42/7	46	48/A/7	126	64/G/6	288	80/A/5	280
42/8	47	48/A/8	126	64/H/7	226	80/A/6	280
42/8/Z	391	48/A/9	126	64/H/9	102	80/A/7	280
42/9	47	48/A/10	126	64/H/9	225	80/A/8	280
42/9/Z	391	48/A/11	126	64/H/9/S	102	80/A/9	279
42/A/1	46	48/A/12	126	64/H/9/S	225	80/A/9/E	278
42/A/2	46	48/A/12	126	64/H/10	102	80/A/10	279
42/A/3	46	48/B/1	127	64/H/10	225	80/A/10/E	278
42/A/4	46	48/B/2	127	64/H/10/S	102	80/A/11	278
42/A/5	47	48/B/7	127	64/H/10/S	225	80/A/11/E	279
42/A/5/Z	391	48/B/8	127	64/H/13	226	80/A/12	278

PRODUCT INDEX IN ALPHANUMERIC ORDER - *INDICE PRODOTTI IN ORDINE ALFANUMERICO*

80/A/12/E	278	93/1	296	112/B/16	128	116/A/18	259
80/A/13	280	93/2	296	112/10	89	116/A/19	259
80/A/14	280	93/3	296	112/11	88	116/A/20	259
80/A/15	280	93/4	296	112/11	90	116/A/21	259
80/A/16	280	94/2	296	113/1	128	116/A/22	259
80/A/17	279	94/3	296	113/2	128	116/B/1	398
80/A/18	279	94/A/1	361	113/3	128	116/B/1	398
80/A/19	278	94/A/2	361	113/4	128	116/B/2	398
80/A/20	278	94/A/3	359	113/5	106	116/D/1	75
80/A/22	280	94/A/4	359	113/6	106	116/D/2	75
80/A/23	280	94/A/5	359	113/7	117	116/E/2	76
80/A/24	279	94/A/6	359	113/8	117	116/E/3	76
80/A/25	279	94/A/10	359	113/9	259	116/E/6	75
80/A/26	278	94/B/1	343	113/10	259	116/F/1	316
80/A/27	278	94/B/5	338	114/1	34	116/F/2	316
80/A/28	280	94/B/6	338	114/2	34	116/F/3	316
80/A/29	280	94/B/7	344	114/4	38	116/F/4	316
80/A/30	280	94/B/8	344	114/4/6000	38	116/F/5	316
80/A/31	279	94/B/9	343	114/5	36	116/F/6	316
80/A/32	279	94/B/10	343	114/5/6000	36	116/F/7	316
80/B/1	284	94/B/11	344	114/6	38	116/F/8	316
80/B/3	279	94/B/12	344	114/6/6000	38	116/F/9	316
80/B/8	279	94/B/14	343	114/7	38	116/F/10	316
80/C/7	280	94/B/15	343	114/7/6000	38	116/F/11	316
80/C/8	280	94/B/16	343	114/8	38	116/F/12	316
80/C/9	280	94/C/1	296	114/8/6000	38	116/F/16	316
80/C/10	280	94/C/2	296	114/9	26	116/F/17	316
80/C/11	280	94/C/3	296	114/9	36	116/F/19	316
80/C/12	279	94/C/4	296	114/9/52	26	116/10	36
80/C/13	280	94/C/5	296	114/9/35X8	26	116/10/S1	36
80/C/14	280	94/C/6	296	114/9/35X8/6000	26	116/10/S3	36
80/C/15	279	94/C/9	295	114/9/6000	26	116/10/S7	36
80/C/16	279	94/C/10	295	114/9/6000	36	116/10/XL	37
80/C/17	280	94/C/11	295	114/A/1	30	116/11	38
80/C/18	280	94/C/12	295	114/A/3	30	116/11/XL	38
80/C/19	280	94/C/13	295	114/A/3/6000	30	116/12	38
80/C/20	280	94/C/14	295	114/A/3/6000/Z	389	116/13	38
80/C/21	280	94/E/1	295	114/A/3/6000/Z	390	116/14	36
80/C/22	279	94/E/2	295	114/A/5	39	116/14/S	36
80/C/23	280	94/E/3	295	114/A/5/6000	39	116/15	38
80/C/24	280	94/E/4	295	114/A/6	39	116/16	38
80/C/25	279	94/E/5	295	114/B/1	30	116/25	38
80/C/26	279	94/E/6	295	114/B/3	34	116/26	37
81/1	290	94/F/3	295	114/B/4	38	116/27	38
81/3	290	94/F/4	295	114/B/5	36	116/28	38
81/5	290	94/F/5	295	114/B/5/5	36	116/29	38
82/1	283	94/F/6	295	114/B/5/S3	36	116/30	37
82/4	343	94/P/1	281	114/B/6	38	116/31	38
82/7	283	94/P/2	281	114/B/8	38	116/32	38
83/1	290	94/P/3	281	114/B/9	36	116/33	361
83/2	343	94/P/4	281	114/B/10	38	116/34	361
83/6	343	94/P/5	282	114/B/11	38	116/35	361
83/7	344	94/P/6	282	114/B/12	36	116/36	36
83/8	344	94/P/7	282	114/B/13	30	116/36/S1	36
83/10	343	94/P/8	282	114/B/13/Z	390	116/37	36
83/11	343	94/P/9	281	114/B/13/S9	30	116/37/S1	36
83/13	343	94/P/10	281	114/B/14	30	116/39	37
84/2	290	94/P/11	281	114/B/14/Z	390	117/1	316
84/6	290	94/P/12	281	114/B/15	30	117/1/L	316
84/7	290	94/Q/1	281	114/B/15/Z	390	117/2	316
85/4	283	94/Q/2	281	114/10	36	117/3	316
85/5	287	94/Q/3	281	114/10/5	36	117/4	316
85/6	344	94/Q/4	281	114/10/6000	36	117/5	316
85/7	284	94/Q/5	281	114/11	38	117/6	316
86/2	287	94/Q/6	281	114/11/6000	38	117/7	316
86/4	287	94/Q/7	281	114/12	38	117/8	316
86/5	287	94/Q/8	281	114/12/6000	38	117/9	316
87/1	287	96/1	94	114/13	36	118/1	24
87/5	287	96/3	94	114/13/6000	36	118/1	281
87/6	287	96/3/5	94	114/14/6000	36	118/1	281
88/9	287	96/4	94	115/1	34	118/1	282
88/A/2	279	97/1	122	115/2	34	118/1	299
88/A/3	287	98/1	88	115/3	34	118/1	300
88/A/5	287	98/B/1	226	115/4	34	118/1	300
88/B/1	278	99/1/C	86	115/5	34	118/1/Q10/6000	24
88/B/4	284	99/2/C	86	116/1	38	118/1/6000	24
88/C/2	298	104/3	92	116/2	36	118/2	24
88/C/3	298	104/4	92	116/2/S1	36	118/2	59
88/E/3	278	105/1/C	89	116/2/S2	36	118/2	281
88/E/4	278	105/2/C	89	116/3	38	118/2	282
88/G/4	278	105/3	89	116/4	38	118/2	284
88/H/1	278	105/5	89	116/5	38	118/2/6000	24
88/H/2	279	105/5/C	89	116/6	36	118/3	24
88/H/2/E	279	106/1	134	116/6/5	36	118/3/6000	24
88/H/3	279	106/2	92	116/7	38	118/4	24
88/H/3/E	278	108/A/1	90	116/8	38	118/4/6000	24
88/H/4	279	108/A/2	90	116/9	38	118/5	24
88/H/4/E	279	109/2	228	116/A/1	359	118/5/6000	24
88/H/5	278	109/3	88	116/A/2	359	118/6	24
88/I/2	281	110/3	90	116/A/3	37	118/6	299
88/I/3	281	110/4	90	116/A/3	338	118/6/6000	24
88/L/3	281	110/5	90	116/A/4	338	118/7	26
88/N/3	289	112/3	117	116/A/5	338	118/7/S	26
88/N/6	289	112/5	87	116/A/6	359	118/7/S/6000	26
88/N/11	290	112/6	87	116/A/6/Z	394	118/7/S1	26
88/N/12	290	112/7	92	116/A/7	359	118/7/S1/6000	26
88/P/1	287	112/8	92	116/A/7/Z	394	118/7/20X6/6000	26
88/P/2	287	112/9	94	116/A/8	38	118/7/6000	26
88/P/3	287	112/B/8	92	116/A/9	37	118/8	26
88/10	287	112/B/9	128	116/A/11	38	118/8/S1	26
91/1	287	112/B/10	128	116/A/12	38	118/8/S1/6000	26
92/1	287	112/B/12	128	116/A/14	38	118/8/6000	26
92/B/3	296	112/B/14	128	116/A/15	38	118/9/S/6000	26
92/B/4	296	112/B/15	128	116/A/16	37	118/9/S1	26

PRODUCT INDEX IN ALPHANUMERIC ORDER - INDICE PRODOTTI IN ORDINE ALFANUMERICO

118/9/S1/6000	26	118/E/4/S2	29	119/9	118	127/3	328
118/A/1	24	118/E/4/S3	29	119/10	118	127/7	328
118/A/1/6000	24	118/E/4/S4	29	119/11	118	127/8	328
118/A/2	24	118/E/5	28	119/12	118	127/13	328
118/A/3	24	118/E/5/S3	29	119/13	118	127/14	328
118/A/3/6000	24	118/E/6	28	119/16	118	127/15	328
118/A/4	24	118/E/6/S3	29	119/17	118	128/1	325
118/A/4/6000	24	118/E/7	28	119/18	118	128/2	325
118/A/5	24	118/E/7/S3	29	119/19	118	128/3	324
118/A/5/6000	24	118/E/8	28	119/20	118	128/4	324
118/A/6	27	118/E/8/S1	28	119/23	118	128/5	324
118/A/6	70	118/E/9	28	119/24	118	128/6	324
118/A/6	71	118/E/9/S1	29	119/25	117	128/6/Z	394
118/A/6/S	27	118/E/10	28	119/27	117	128/7	324
118/A/6/S/L6	27	118/E/12	28	119/27	125	128/7/Z	394
118/A/6/S/6000	27	118/E/13	28	119/28	125	128/8	324
118/A/6/S5	27	118/E/14	28	120/1	248	128/8/Z	394
118/A/6/50X8	27	118/E/15	28	120/2	248	128/9	324
118/A/6/50X8/6000	27	118/E/16	29	120/3	248	128/9/Z	394
118/A/6/6000	27	118/E/17	28	121/4	248	128/B/2	326
118/A/7	27	118/E/19	28	121/5	248	128/C/2	258
118/A/7/6000	27	118/F/1	41	121/6	248	128/C/5	327
118/A/8	27	118/F/2	41	121/7	248	128/C/6	327
118/A/8/6000	27	118/F/3	41	121/8	248	128/C/8	327
118/A/9	27	118/F/6	41	121/9	248	128/C/9	327
118/A/9/S	27	118/F/8	38	121/10	248	128/C/10	327
118/A/9/S/6000	27	118/F/8/3000	38	121/11	248	128/C/11	327
118/A/9/6000	27	118/F/9	38	122/3	253	128/C/13	327
118/A/13	23	118/F/10	38	122/6	252	128/C/14	327
118/A/15	23	118/H/1	116	122/A/1	252	128/C/15	327
118/B/1	89	118/H/2	116	123/1	316	128/D/9	249
118/C/3	235	118/H/3	118	123/3	256	128/10	324
118/C/4	235	118/H/4	118	123/4	253	128/11	324
118/C/9	235	118/H/5	40	123/5	256	128/12	324
118/C/10	235	118/H/7	40	123/6	252	128/13	324
118/C/11	235	118/H/8	40	123/7	252	128/14	324
118/C/12	235	118/H/9	40	124/1	255	128/16	325
118/C/20	235	118/H/10	40	124/2	255	128/17	325
118/C/20/1200	235	118/H/11	40	124/3	255	128/18	325
118/C/21	235	118/H/12	40	124/4	255	128/19	325
118/C/22	235	118/H/13	40	124/5	255	128/20	325
118/C/23	235	118/H/14	40	124/6	252	128/21	325
118/C/23/1200	235	118/H/15	40	124/7	255	128/22	325
118/C/24	235	118/H/16	40	124/8	255	128/23	325
118/C/25	235	118/H/18	40	124/9	255	128/24	325
118/C/26	235	118/H/19	40	124/11	244	128/25	325
118/C/32	235	118/H/20	40	124/12	244	128/26	325
118/C/33	235	118/H/21	40	124/13	244	128/27	325
118/C/34	235	118/H/22	40	124/14	244	128/28	325
118/C/35	235	118/H/24	40	125/1	252	128/29	258
118/C/36	235	118/H/25	40	125/2	252	128/30	258
118/C/37	235	118/H/26	40	125/4	253	128/31	258
118/C/38	235	118/H/30	116	126/1	256	128/32	258
118/C/39	235	118/10	27	126/2	256	128/33	258
118/C/39/1200	235	118/11	27	126/3	338	128/34	258
118/C/40	235	118/11/6000	27	126/6	252	128/35	258
118/C/40/T16	235	118/12	27	126/8	255	128/36	325
118/C/41	235	118/12	75	126/9	252	128/37	325
118/C/42	235	118/12	75	126/A/1	254	128/38	325
118/C/42/1200	235	118/12/6000	27	126/A/2	251	128/39	325
118/C/43	235	118/13	27	126/B/1	255	129/1	249
118/C/44	235	118/13	36	126/B/2	255	129/2	249
118/C/44/1200	235	118/13/6000	27	126/B/3	255	129/3	249
118/C/45	235	118/13/6000	36	126/B/4	252	129/4	249
118/C/46	235	118/14	27	126/B/5	254	129/5	250
118/C/47	235	118/14	36	126/B/6	255	129/6	250
118/C/48	235	118/14/S2	27	126/B/7	255	129/7	241
118/C/49	235	118/14/6000	27	126/B/8	255	129/7	249
118/C/50	235	118/14/6000	36	126/C/1	253	129/8	241
118/C/51	235	118/15	25	126/C/2	253	129/8	249
118/C/52	235	118/15/6000	25	126/C/3	254	129/9	240
118/C/53	235	118/16	25	126/C/4	254	129/9	249
118/C/54	235	118/16/6000	25	126/C/5	254	129/10	240
118/C/55	235	118/17	25	126/C/6	252	129/10	249
118/C/56	235	118/17	284	126/C/7	256	129/11	242
118/C/57	235	118/17/6000	25	126/C/8	256	129/11	249
118/C/58	235	118/18	25	126/D/1	253	129/12	242
118/C/59	235	118/18/6000	25	126/E/1	254	129/12	249
118/C/60	235	118/19	25	126/E/2	254	129/15	248
118/C/61	235	118/19/6000	25	126/F/1	324	129/16	249
118/C/62	235	118/20	25	126/F/2	324	129/18	240
118/C/63	235	118/20/6000	25	126/F/3	324	129/18	249
118/C/63	250	118/21	25	126/F/4	324	129/19	249
118/C/64	235	118/22	25	126/F/5	324	129/20	249
118/C/64	250	118/22/6000	25	126/F/6	325	130/1	241
118/C/65	235	118/23	25	126/F/7	325	130/2	241
118/C/65	250	118/23/6000	25	126/F/8	325	130/3	241
118/C/66	235	118/24	24	126/F/9	325	130/4	241
118/C/66	250	118/24/6000	24	126/F/10	325	130/6	241
118/C/67	235	118/25	24	126/F/11	326	130/7	241
118/C/67	250	118/25/6000	24	126/F/12	326	130/8	241
118/C/68	235	118/26	27	126/F/13	326	130/10	241
118/C/68	250	118/28	27	126/F/14	326	130/31	240
118/C/72	235	118/28/6000	27	126/13	255	130/32	240
118/C/96	235	118/30	27	126/14	255	130/33	240
118/C/97	235	119/1	41	126/15	256	130/34	240
118/C/106	235	119/1/5400	41	126/16	256	130/35	240
118/E/1	28	119/2	41	126/17	253	130/36	240
118/E/2	28	119/2/5400	41	126/18	256	130/37	240
118/E/2/S1	29	119/3	41	126/19	252	130/38	240
118/E/3	28	119/3/5400	41	126/20	252	130/39	240
118/E/3/S4	29	119/4	118	126/21	255	130/40	240
118/E/3/S5	29	119/6	118	127/1	253	130/41	242
118/E/4	28	119/7	116	127/2	253	130/42	242

PRODUCT INDEX IN ALPHANUMERIC ORDER - INDICE PRODOTTI IN ORDINE ALFANUMERICO

130/43	242	134/H/1	119	156/1	312	164/8	369
130/46	242	134/10	96	156/2	312	164/9	369
130/50	242	134/12	96	156/3	312	164/10	369
132/1	239	134/14	96	156/4	312	164/10	369
132/8	239	134/17	241	156/5	312	167/3	260
132/9	239	134/18	241	156/6	312	167/4	260
132/A/1	239	134/19	241	156/A/1	311	167/5	261
132/A/5	239	134/20	241	156/A/6	311	167/6	260
132/A/9	239	134/21	241	156/A/8	363	167/7	261
132/A/11	239	134/22	241	156/A/10	363	167/8	260
132/A/23	239	134/28	239	157/1	310	167/9	261
132/B/10	243	134/29	222	157/2	310	167/10	261
132/B/15	243	134/35	222	157/3	310	167/11	260
132/B/37	238	134/36	222	157/4	310	167/12	261
132/B/38	238	134/39	222	157/5	310	167/13	261
132/B/39	238	134/43	222	157/6	310	167/14	260
132/B/40	238	134/46	222	157/7	310	167/15	248
132/B/41	238	136/1	340	157/8	310	167/15	260
132/B/42	238	136/2	340	157/9	310	167/16	248
132/B/43	238	136/3	340	157/10	310	167/16	260
132/B/44	238	136/4	340	157/11	310	168/2	366
132/B/45	238	136/5	340	157/12	310	168/4	366
132/B/56	238	136/6	340	157/13	310	169/1	367
132/B/57	238	136/7	340	157/14	310	169/2	367
132/B/58	238	136/10	340	157/15	310	169/8	367
132/B/59	238	136/11	340	157/16	312	169/11	365
132/B/63	238	136/12	340	157/17	311	169/12	365
132/B/64	238	136/13	340	158/1	42	169/14	365
132/B/65	238	137/7	339	158/2	42	169/15	365
132/B/66	238	137/8	339	158/3	42	170/1	367
132/B/67	238	137/9	339	158/4	42	170/2	367
132/B/69	238	137/10	339	158/5	42	170/3	367
132/B/70	238	137/12	359	158/5	42	170/5	367
132/B/71	238	138/1	338	158/6	42	170/A/1	367
132/B/72	238	138/2	338	158/7	42	170/A/2	369
132/B/85	238	138/3	339	158/8	42	170/A/5	366
132/B/86	238	138/4	338	158/9/C	32	170/A/7	367
132/B/87	238	138/6	339	158/9/C/6000	32	170/A/9	367
132/B/88	238	138/7	340	158/B/1	334	170/A/10	367
132/C/1	238	138/8	340	158/B/2	334	171/1	354
132/C/2	238	138/10	340	158/B/3	334	171/2	354
132/C/3	238	138/11	340	158/B/4	334	171/3	354
132/C/4	238	138/12	340	158/B/5	334	171/4	354
132/C/5	238	138/13	340	158/B/6	335	171/5	354
132/C/6	238	138/14	339	158/B/7	335	171/6	354
132/C/7	238	138/15	338	158/B/8	335	171/7	354
132/C/8	238	138/16	340	158/B/11	261	171/8	354
132/C/9	238	140/B/1	340	158/10/C	32	171/9	354
132/C/10	238	140/C/3	341	158/10/C/6000	32	171/10	354
132/C/12	238	140/D/1	341	158/12/C	32	171/11	354
132/C/12	250	140/D/2	341	158/12/C/6000	32	171/12	354
132/C/13	238	140/E/1	341	158/49	42	171/13	354
132/C/13	250	140/E/2	341	158/49	58	171/14	354
132/C/13	250	140/E/3	341	158/50	42	171/37	362
132/C/14	238	140/H/1	345	158/50	58	171/38	362
132/C/15	238	140/H/2	345	158/51	42	171/39	362
132/C/15	250	140/H/3	341	158/51	58	171/40	362
132/C/16	238	140/I/1	355	158/52	42	171/41	362
132/C/17	238	140/I/2	341	158/52	58	171/42	362
132/C/18	238	140/I/3	341	158/53	42	178/20	260
132/C/18	250	144/3	112	158/53	58	178/22	260
132/C/19	238	145/4	112	158/54	42	178/29	260
132/C/19	250	145/5	112	158/54	58	178/30	260
132/C/20	238	146/1	112	159/1	334	178/35	260
132/C/20	250	146/2	113	159/2	334	178/36	260
132/C/21	238	146/3	113	159/3	334	178/37	260
132/C/21	250	146/4	112	159/4	334	179/1	236
132/C/22	238	147/1	113	159/5	334	180/49	243
132/C/23	238	147/2	113	159/6	334	180/50	24
132/C/28	238	148/1	110	159/7	334	180/50/6000	24
132/C/29	238	148/2	110	159/9	334	180/51	27
132/C/32	238	149/1	110	159/10	334	180/53	24
132/D/1	238	149/2	110	160/A/1	399	180/53/6000	24
132/D/2	238	149/3	110	160/B/1	400	180/54	24
132/D/3	238	149/4	110	160/B/2	401	180/54/6000	24
132/D/4	238	150/3	138	160/B/3	401	181/6	359
132/D/5	238	152/1	303	160/B/4	401	181/10	368
132/D/6	238	152/4	297	160/B/5	401	181/11	368
132/D/7	238	152/5	303	160/B/6	400	181/12	368
132/D/8	238	152/7	303	160/B/7	400	181/13	369
132/D/9	238	154/1	323	160/C/1	138	181/14	369
132/D/10	238	154/2	323	160/D/11	400	181/15	368
132/D/11	238	154/3	323	160/D/12	400	199/2	355
132/D/12	238	154/5	323	160/E/4	270	199/3	355
132/D/13	238	154/6	138	160/E/7	404	199/11	355
132/D/14	238	154/A/1	323	160/E/8	404	199/13	355
132/D/15	238	154/A/2	323	160/G/C	404	199/14	355
132/D/16	238	154/A/3	323	160/G/D	404	199/16	355
132/D/17	238	154/A/4	323	160/G/G	404	199/17	355
132/D/18	238	154/A/5	323	160/H/A	404	200/5	56
132/D/19	238	154/A/6	323	160/H/C	404	200/5/S28	57
132/D/20	238	154/A/7	323	160/H/N	404	200/5/S44	57
133/8	239	154/B/1	323	160/42	400	200/5/S45	57
134/1	96	154/B/2	323	160/43	403	200/5/S46	57
134/2	96	154/B/3	323	160/44	403	200/7	56
134/4	96	154/B/4	323	160/45	403	200/8	56
134/6	96	154/B/5	323	160/46	403	200/9	56
134/A/12	96	154/B/6	323	161/7	401	200/12	56
134/F/3	131	154/B/7	138	161/17	401	200/14	56
134/F/4	131	155/1	323	161/34	401	200/15	56
134/F/8	121	155/2	323	164/1	369	200/16	56
134/G/1	131	155/3	323	164/4	369	200/18	56
134/G/2	131	155/4	323	164/5	369	200/18/S12	57
134/G/4	136	155/7	323	164/7	369	200/18/S13	57

PRODUCT INDEX IN ALPHANUMERIC ORDER - *INDICE PRODOTTI IN ORDINE ALFANUMERICO*

200/18/S14	57	505/4	91	578/4	103	599/2/6000	23
200/18/S24	57	507/1	87	578/5	103	599/3	23
202/1	316	507/2	87	578/6	103	599/3/6000	23
202/2	316	508/1	86	578/9	103	599/4	23
202/4	316	508/2	86	578/10	103	599/5	23
227/29	370	508/3/C	81	578/13	103	599/5/6000	23
227/30	370	508/4/C	81	578/13	225	599/6	23
227/30	370	510/1	151	578/14	103	599/6/6000	23
227/31	370	511/1	151	578/14	225	599/7	23
227/32	370	512/2	89	578/15	103	599/7/6000	23
227/51	370	518/1	138	578/15	225	599/9	23
227/52	370	523/1	80	578/16	103	599/9/6000	23
227/54	370	523/4	86	578/16	225	600/1	23
446/1	267	525/1	112	578/17	103	600/2	23
446/4	269	527/2	112	578/17	225	600/2	292
449/1	268	527/3	112	578/18	103	600/3	23
450/1	267	529/1	113	578/18	225	600/3/6000	23
452/2	282	529/4	113	578/19	103	600/4	23
453/2	264	529/5	112	578/19	225	600/4	285
453/3	264	529/7	122	578/20	103	600/4/6000	23
453/4	264	529/8	112	578/20	225	600/5	23
453/5	266	530/1	111	582/1	306	600/6	23
453/8	152	530/2	111	582/2	306	600/7	23
453/9	152	530/3	111	583/1	306	600/7/6000	23
454/3	267	531/2	329	584/1	119	600/8	23
455/2	268	531/3	329	584/2	119	600/8/6000	23
456/1	155	533/2	111	584/3	132	600/9	23
456/3	155	533/4	111	584/4	119	600/9/6000	23
457/1	271	533/5	329	584/5	119	601/2	137
457/2	272	533/6	329	584/A/2	132	601/10	137
458/1	296	533/7	329	584/A/3	132	602/15	137
459/1	269	533/8	329	584/A/4	119	602/18	137
460/2	274	535/4	329	584/A/5	119	604/2	179
463/3	153	535/5	329	584/A/6	119	604/5	343
463/4	153	535/6	329	584/B/1	119	604/6	179
464/1	153	536/2	111	584/B/2	119	604/7	179
464/2	153	536/3	112	584/B/3	120	604/10	343
465/1	131	536/4	112	584/B/4	132	604/11	341
466/1	131	537/1	110	585/1	96	604/12	341
466/2	131	537/3	110	586/3	131	605/1	47
467/1	131	537/4	110	586/6	97	605/2	47
468/1	131	537/5	110	586/6	222	605/3	47
468/2	131	537/6	110	586/7	97	605/4	47
468/3	131	537/7	110	586/7	222	605/5	47
468/4	131	537/8	110	586/8	97	605/6	47
469/1	131	537/9	110	586/8	222	605/7	47
471/1	152	538/1	121	586/9	97	605/8	47
471/2	274	539/1	119	586/9	222	606/1	46
473/1	154	539/2	150	586/10	97	606/2	46
474/1	154	540/1	300	586/10	222	606/3	46
475/1	154	540/2	144	586/11	97	606/4	46
475/2	154	541/1	145	586/11	222	607/1	46
479/1	135	541/2	145	586/12	97	607/2	46
479/2	154	543/1	142	586/12	222	607/3	46
480/1	272	543/3	142	586/13	97	607/4	46
483/1	148	544/1	142	586/13	222	607/4	47
485/1	147	544/2	142	586/14	97	608/2	52
486/2	147	548/2	142	586/15	97	608/3	52
487/1	150	555/1	142	586/15	222	608/5	51
488/1	150	560/1	102	586/18	229	608/6	51
489/1	94	560/2	102	586/19	229	608/7	51
489/2	94	561/3	102	586/20	229	608/8	51
490/1	94	561/4	102	587/12	222	611/1	59
490/2	94	561/5	102	587/24	222	611/2	59
491/3	312	561/6	102	587/41	96	611/3	59
491/4	312	562/1	102	587/42	96	614/4	59
491/5	312	562/2	102	587/44	96	614/5	59
491/6	312	563/1	102	587/45	96	614/6	59
491/8	310	563/2	102	587/46	96	615/1	124
491/8	311	563/4	102	587/48	96	615/2	124
491/8/D89	310	567/1	382	589/4	229	615/3	124
491/8/D127	310	567/2	102	589/5	229	615/4	124
491/8/D133	310	570/1	132	591/2	226	617/1	124
491/8/D140	310	570/4	138	593/1	260	617/3	124
491/9	311	571/1	102	593/3/S1	260	617/4	124
491/16	310	571/2	102	593/3/S4	260	617/6	124
491/17	310	571/4	102	593/10	260	617/7	124
493/1	88	572/1	102	593/11	260	620/1	61
493/2	88	572/1	225	595/7/S	56	621/1	61
494/1	89	572/2	225	595/7/S	259	622/1	288
496/3	81	572/3	102	595/12	137	622/1	289
496/B/1	92	572/3	225	595/18	94	622/1	306
496/B/2	92	572/4	225	596/2	303	622/1/6000	26
496/B/3	92	572/5	219	596/4	297	622/2	290
496/C1/C	82	572/7	219	596/4/S3	56	622/3	26
496/C2/C	82	573/2	102	596/4/S3	260	622/3/6000	26
496/C3/C	93	573/4	102	597/4	136	622/4	26
497/1/C	81	573/10	102	597/5	60	622/4/5	26
497/2/C	81	574/5	243	598/1	23	622/4/5/6000	26
498/1	147	574/13	256	598/2	23	622/4/6000	26
499/1/C	83	576/1	103	598/3	23	622/5/6000	26
499/2/C	83	576/2	103	598/4	23	622/6	26
500/1	84	576/3	103	598/5	23	622/6/6000	26
500/2	84	576/4	103	598/6	23	623/1	26
501/1	84	576/5	103	598/7	23	623/1	283
501/2	84	576/6	103	598/8	23	623/1	285
501/3	82	577/2	103	598/9	23	623/1	288
502/1	88	577/3	103	598/11	23	623/1/6000	26
502/2	88	577/5	103	598/12	23	623/2	26
503/1	80	577/9	103	598/14	23	623/2/6000	26
504/1	102	577/10	103	598/16	23	623/3	26
504/2/C	83	578/1	103	598/18	23	623/3/6000	26
504/3/C	83	578/2	103	599/1	23	623/4	25
505/3	91	578/3	103	599/2	23	623/4/6000	25

PRODUCT INDEX IN ALPHANUMERIC ORDER - INDICE PRODOTTI IN ORDINE ALFANUMERICO

623/5	25	660/12	338	686/14	294	722/6	249
623/5/6000	25	660/12	359	686/15	294	722/7	249
623/6/6000	25	661/1	346	686/16	294	722/8	249
623/7	25	661/2	346	688/4	284	723/2	248
623/7/6000	25	661/3	346	688/5	284	723/5	248
623/8	25	661/4	346	689/1	345	724/1	256
623/8/6000	25	661/5	346	689/3	345	725/1	253
623/9	25	662/1	346	689/8	346	725/2	254
623/9/6000	25	662/2	346	689/9	346	725/3	254
623/11	25	662/3	346	690/1	345	725/4	254
623/11/6000	25	662/4	346	690/2	345	725/5	254
623/12	26	662/5	346	690/3	342	726/1	253
623/12/6000	26	662/6	346	690/4	342	726/2	253
625/3	25	663/1	346	691/2	342	726/3	252
625/3/6000	25	663/2	346	691/5	311	726/4	252
625/4	25	663/3	346	691/6	341	726/6	255
625/5	25	663/4	346	691/7	341	726/7	255
625/5/6000	25	663/5	346	692/1	342	726/9	254
625/6	25	663/6	346	692/2	345	726/10	254
625/8	282	663/7	346	692/3	345	726/11	254
625/8	301	663/8	346	692/4	345	726/12	254
625/9	25	664/1	338	692/5	345	726/13	254
625/9	301	664/1	347	692/7	345	726/15	254
626/1	41	664/2	338	692/8	342	726/16	254
626/2	41	664/2	347	692/9	345	726/17	254
626/10	25	664/3	346	692/10	342	726/18	254
626/10/6000	25	664/3	347	694/9	342	726/19	254
626/12	25	664/4	346	694/10	342	726/20	244
626/12	300	664/4	347	694/11	342	726/21	244
626/12/6000	25	664/5	339	694/13	342	726/22	244
626/14	25	664/5	347	695/1	345	726/23	244
626/14/6000	25	664/6	346	695/2	345	727/1	252
626/15	25	664/6	347	695/4	338	727/2	252
626/15/6000	25	664/7	346	695/5	345	727/3	252
626/16	25	664/7	347	695/6	362	727/4	253
626/16/6000	25	664/8	346	695/7	362	727/5	253
628/2	283	664/8	347	695/8	362	727/6	253
628/6	283	664/9	346	695/9	362	727/7	255
630/1	292	664/9	347	695/10	362	727/8	255
630/10	292	664/10	339	695/11	362	727/9	255
634/2	300	664/11	339	696/1	76	727/10	256
634/4	283	665/1	338	696/2	339	727/11	256
634/4	283	665/2	338	696/3	184	727/18	244
634/5	283	665/4	339	697/1	338	727/19	244
635/2	282	665/5	339	697/2	339	727/20	244
635/4	282	665/6	339	697/3	338	727/21	244
636/1	301	666/2	342	697/4	338	727/22	244
636/6	301	666/4	344	697/5	362	727/23	244
638/6	311	666/5	342	697/7	362	727/24	244
639/1	301	666/8	341	700/1	341	727/25	244
639/2	301	670/2	143	700/2	342	727/26	244
641/1	288	670/4	143	700/4	342	727/27	244
641/2	288	671/1	143	700/5	341	727/28	244
641/5	288	671/2	143	701/1	338	727/29	244
641/6	288	671/3	143	701/3	339	727/34	244
641/7	288	671/4	143	701/10	359	727/35	244
641/8	288	673/1	345	702/2	340	727/36	244
642/3	291	673/2	345	704/9	340	727/37	244
642/4	291	673/3	344	704/10	404	728/1	402
645/1	290	675/1	344	705/2	404	731/1	257
645/2	290	675/2	344	705/3	341	731/3	257
645/3	290	675/4	344	705/5	341	731/5	257
645/7	288	675/5	344	705/7	339	731/6	257
646/1	292	675/6	344	707/5	341	731/7	257
646/2	292	675/7	344	707/6	404	732/1	257
646/5	292	675/8	344	707/8	404	732/2	257
648/2	281	675/9	344	708/14	404	732/3	257
648/3	281	675/10	344	709/12	404	733/1	257
651/4	283	675/11	344	709/17	341	733/2	257
653/1	71	675/12	344	710/4	404	733/3	257
653/2	71	675/13	344	710/10	404	733/4	257
653/3	71	675/14	344	710/11	341	734/1	257
653/4	71	675/15	344	711/4	339	734/3	257
653/5	70	676/2	344	711/5	338	735/1	257
654/1	71	676/3	345	711/6	338	735/2	257
654/2	70	678/1	143	713/1	184	735/3	257
654/3	70	679/1	271	713/2	184	736/1	257
654/4	70	679/2	271	714/1	184	736/2	257
654/5	70	679/3	272	715/1	184	736/3	257
654/5	71	680/2	270	715/2	184	737/1	320
654/5	359	681/1	146	716/1	184	737/2	320
655/1	291	681/2	146	716/2	184	737/3	320
655/2	291	681/3	146	716/3	184	737/4	320
656/1	291	681/4	146	716/4	184	737/5	320
656/2	291	682/4	146	717/5	343	737/6	320
656/B/1	339	682/5	146	717/5/S1	184	737/7	320
656/B/2	339	682/10	296	717/5/S1	342	737/8	320
656/B/3	339	684/2	283	717/5/S3	184	738/8	320
656/B/4	339	684/5	283	717/5/S3	342	738/9	320
656/B/6	339	685/1	146	717/5/S4	342	739/1	326
656/B/7	344	685/2	146	719/1	270	739/2	326
656/B/8	344	685/3	146	719/2	270	739/3	326
658/3	296	685/4	146	720/1	270	739/4	326
658/7	289	685/5	146	720/2	267	739/5	326
658/8	289	685/6	146	720/3	343	739/6	326
659/10	289	686/2	294	722/1	249	741/3	327
659/11	289	686/5	294	722/2	249	741/4	327
660/4	346	686/7	294	722/3	241	741/5	327
660/7	346	686/8	294	722/3	249	741/6	327
660/8	346	686/9	294	722/4	241	741/7	327
660/10	338	686/10	294	722/4	249	741/8	327
660/10	359	686/11	294	722/5	240	742/2	323
660/11	338	686/12	294	722/5	249	742/4	323
660/11	359	686/13	294	722/6	240	743/1	401

PRODUCT INDEX IN ALPHANUMERIC ORDER - INDICE PRODOTTI IN ORDINE ALFANUMERICO

743/2	401	772/1	378	819/15	358	846/19	373
743/4	401	772/3	378	819/15/Z	394	846/21	374
743/5	401	772/5	378	819/16	358	846/22	374
743/10	401	772/6	378	819/16/Z	394	849/1	371
744/4	400	772/8	383	819/17	358	849/2	371
744/7	400	772/10	383	819/18	358	849/3	371
745/3	329	772/11	383	830/1	369	849/4	371
746/1	330	772/17	378	830/3	369	850/1	354
746/2	330	793/5	404	830/7	369	850/2	354
746/3	330	793/10	404	830/9	369	850/3	354
746/4	330	795/9	402	830/10	369	850/4	354
746/5	330	795/10	402	830/13	369	850/5	354
746/6	330	797/1	81	830/16	369	850/6	354
747/1	331	797/1	84	830/17	369	850/7	354
747/2	331	797/2	83	830/18	369	850/8	354
747/3	331	797/5	81	830/20	369	850/9	354
747/4	331	797/5	84	830/21	369	850/10	354
747/5	331	797/6	83	832/1	366	850/11	354
747/6	331	797/7	83	832/3	366	850/12	354
747/7	331	798/2	91	832/4/DX	366	850/13	354
747/8	331	799/1	91	832/4/SX	366	850/14	354
747/9	331	799/3	87	832/6	366	850/15	354
747/10	331	800/1	88	832/7	366	850/16	354
747/11	331	801/1	102	832/8	366	850/17	354
747/12	324	801/2	103	833/2	365	850/18	354
747/12/Z	394	801/5	103	833/6	365	850/19	354
747/13	324	801/6	86	833/7	366	850/20	354
747/13/Z	394	801/7	102	833/8	366	850/21	354
747/14	324	801/8	103	833/9	366	850/22	354
747/14/Z	394	802/1	94	834/1	367	850/23	354
747/15	325	802/2	148	834/2	367	850/24	354
747/16	325	802/4	359	834/3	365	850/25	354
747/17	325	802/5	359	836/1	366	850/26	354
747/18	324	810/1	32	836/5	366	850/27	354
747/19	324	810/1/6000	32	836/6	366	850/28	354
747/20	324	810/2	32	836/7	366	850/29	354
747/21	325	810/2/6000	32	836/8	366	850/30	354
747/22	325	810/5	32	836/9	366	850/31	354
747/23	325	810/7/C	32	837/2	366	850/32	354
749/1	258	810/7/C/6000	32	837/3	366	850/33	354
749/2	258	810/A/3	32	838/1	367	850/34	354
749/3	258	810/A/5	32	839/5	367	850/35	354
749/4	258	810/A/12	32	839/6	367	850/36	354
749/5	258	810/A/14	32	839/7	367	850/37	354
749/7	258	810/B/1/T	36	839/8	367	850/38	354
749/8	258	810/B/2/T	36	840/4	368	850/39	354
749/9	258	810/B/3/T	36	841/1	368	850/40	354
749/10	258	810/B/4/T	36	841/2	368	850/41	354
749/12	258	810/B/5/T	36	841/5	368	850/42	354
749/13	258	810/B/6/T	36	841/7	359	850/43	354
749/14	258	810/B/7/T	36	844/1	372	850/44	354
749/16	258	810/B/8/T	36	844/2	372	850/45	354
749/17	258	810/B/13/T	36	844/3	372	850/46	354
749/18	258	810/B/14/T	36	844/4	372	850/47	354
749/19	258	810/B/15/T	36	844/5	372	850/48	354
749/20	258	810/B/16/T	36	844/6	372	850/49	354
749/22	259	810/B/18/T	36	844/7	372	850/50	354
750/1	341	810/B/19	30	844/8	372	850/51	354
751/1	344	810/B/19/T	36	844/9	372	850/52	354
753/1	304	810/B/20/T	36	844/10	372	851/1	354
753/2	304	810/11	32	844/11	372	851/2	354
753/3	304	811/1	34	844/12	372	851/3	354
753/4	304	811/2	30	844/13	372	851/4	354
753/5	304	811/3	30	844/14	372	851/5	354
753/6	304	811/3/T	36	844/15	372	851/6	354
753/7	304	811/4/T	36	844/16	372	851/7	354
753/9	304	811/5/T	36	844/17	372	851/8	354
756/1	274	811/6/T	36	844/18	372	851/9	354
756/2	348	811/7/T	36	844/19	372	851/10	354
756/3	274	811/8/T	36	844/20	372	851/11	355
756/4	348	812/2	32	844/22	372	851/14	355
756/5	274	812/3	32	844/23	372	851/15	355
756/6	348	812/4	32	844/24	372	851/17	355
756/7	274	812/5/S4	32	844/25	372	851/18	355
756/8	348	812/6	32	844/26	372	852/1	355
756/10	274	812/6/5	32	844/28	372	852/2	355
756/11	274	812/7	32	844/29	372	852/4	352
756/12	348	812/8	32	844/30	372	852/5	352
756/13	348	812/9	34	844/33	372	852/6	352
756/14	348	812/10	34	844/34	372	852/7	352
756/16	348	812/11	34	845/2	373	852/8	352
757/5	348	812/12	30	845/3	373	852/9	352
768/1	383	812/12/5	30	845/4	373	852/10	352
768/4	380	812/12/T	36	845/5	373	852/11	352
768/5	380	812/12/T/5	36	845/6	373	852/13	352
768/6	382	812/13/T	36	845/7	373	852/14	352
768/7	380	812/15	30	845/8	374	852/15	352
768/9	380	812/15/T	36	845/9	374	891/3	345
769/4	382	816/3	403	845/10	374	892/2	345
769/5	380	816/6	403	845/12	374	ESP/24	409
769/6	380	816/14	403	845/13	374	1009/1	267
769/7	381	818/2	403	845/14	374	1009/2	267
769/8	381	819/1	358	845/15	374	1010/1	268
769/11	379	819/1/Z	394	845/16	374	1010/2	268
770/3	383	819/2	358	845/17	372	1010/3	266
770/4	383	819/2/Z	394	845/18	373	1011/1	268
770/5	383	819/3	358	845/19	373	1011/3	268
770/8	383	819/4	358	845/26	374	1011/3	269
770/9	383	819/5	358	846/4	372	1012/1	269
770/10	383	819/6	358	846/5	374	1012/2	269
770/12	383	819/7	358	846/6	373	1013/1	266
770/14	383	819/8	358	846/13	373	1013/2	266
771/3	384	819/9	358	846/14	373	1014/3	266
771/6	384	819/12	316	846/18	373	1015/1	266

PRODUCT INDEX IN ALPHANUMERIC ORDER - INDICE PRODOTTI IN ORDINE ALFANUMERICO

1015/2	266	1111/3	139	1165/1	261	1254/3	236
1017/1	266	1115/1	136	1165/2	261	1254/5	236
1017/2	264	1115/2	136	1165/4	261	1256/5	93
1019/1	264	1116/1	142	1165/5	260	1258/4	236
1019/2	264	1116/2	142	1165/6	260	1258/17	236
1019/3	264	1116/3	142	1166/1	183	1258/19	236
1019/4	266	1116/4	142	1166/2	183	1258/21	236
1019/5	266	1117/1	142	1166/3	183	1258/24	236
1019/6	266	1117/2	142	1166/4	183	1259/4	236
1019/7	267	1117/3	142	1167/1	183	1259/8	236
1019/8	267	1118/1	141	1167/2	183	1259/22	236
1019/9	267	1122/1	133	1167/3	183	1259/23	236
1020/1	269	1122/2	122	1167/4	183	1259/24	236
1028/2	269	1122/2	133	1170/1	179	1260/55	241
1032/1	135	1122/3	133	1170/2	179	1260/57	241
1038/1	148	1124/1	120	1170/5	179	1260/59	241
1038/3	284	1124/2	120	1171/1	179	1260/67	241
1039/2	284	1124/3	121	1171/2	183	1260/69	241
1043/1	135	1125/2	131	1176/1/5	109	1260/71	241
1043/2	211	1126/2	134	1176/2/5	109	1261/39	239
1045/5	144	1127/2	119	1176/3/5	109	1261/55	241
1045/6	144	1127/4	132	1177/5	109	1261/57	241
1045/7	144	1128/2	132	1177/6	109	1261/59	241
1045/8	144	1128/3	132	1177/7	109	1261/67	241
1046/1	144	1128/5	132	1177/8	109	1261/69	241
1046/2	144	1130/1	132	1179/1	109	1261/71	241
1046/3	281	1130/2	132	1179/2	109	1262/1	241
1046/4	281	1130/5	132	1179/3	109	1262/2	241
1046/5	281	1133/25	136	1179/4	109	1262/3	241
1046/6	281	1135/2	103	1184/1	82	1262/4	241
1046/7	281	1135/3	103	1184/2	82	1262/5	241
1049/1	149	1135/4	103	1184/4	82	1262/6	241
1050/1	144	1136/2	103	1184/5	84	1262/7	241
1050/2	144	1136/3	103	1184/6	93	1262/9	241
1050/3	144	1136/4	103	1185/1	89	1262/11	241
1050/4	144	1136/5	103	1185/2	84	1262/13	240
1051/1	149	1136/6	103	1185/4	93	1262/14	240
1051/2	149	1136/7	103	1185/5	93	1262/15	240
1051/3	149	1136/8	103	1187/1	84	1262/16	240
1051/4	145	1136/9	103	1187/2	93	1262/17	240
1051/5	145	1136/10	103	1187/3	84	1262/18	240
1053/1	130	1137/3	102	1187/4	83	1262/19	240
1054/1	130	1137/7	102	1189/1	89	1262/20	240
1054/2	130	1137/7	225	1189/3	80	1262/21	240
1054/3	130	1137/8	102	1189/4	80	1262/23	240
1054/4	130	1137/8	225	1192/1	92	1262/25	241
1054/5	130	1137/9	225	1192/2	92	1262/26	241
1054/6	130	1137/10	225	1192/3	92	1262/27	241
1055/4	136	1137/12	225	1192/4	92	1262/28	241
1055/5	136	1137/13	225	1192/7	83	1262/29	241
1056/1	136	1137/14	225	1192/9	82	1262/30	241
1056/2	136	1138/3	102	1198/1	85	1262/32	241
1056/4	136	1138/4	102	1198/2	85	1262/33	241
1056/10	136	1138/7	103	1198/5	85	1262/34	241
1058/1	126	1138/8	103	1198/6	85	1262/35	241
1060/3	129	1141/1	134	1198/7	111	1262/36	241
1061/2	129	1141/2	134	1198/8	115	1262/37	240
1064/3	150	1142/1	140	1199/1	86	1262/38	240
1066/1	129	1142/2	140	1199/3	93	1262/39	240
1066/2	129	1144/1	297	1205/1	109	1262/40	240
1066/3	129	1144/2	297	1206/1	148	1262/41	240
1066/4	209	1144/5	297	1207/1	113	1262/42	240
1066/5	209	1145/1	297	1207/2	113	1262/43	240
1066/6	129	1146/1	302	1208/5	111	1262/44	240
1067/2	138	1146/3	302	1211/4	138	1262/45	240
1067/3	138	1147/1	302	1212/3	297	1263/1	241
1068/1	129	1147/2	302	1212/4	297	1263/2	241
1068/2	129	1147/3	302	1223/2	111	1263/3	241
1068/3	129	1147/5	302	1229/1	114	1263/4	241
1068/4	129	1148/1	116	1229/2	114	1263/5	241
1071/1	129	1148/2	116	1229/4	114	1263/6	241
1071/3	129	1148/3	116	1229/5	114	1263/7	241
1071/4	129	1148/5	116	1229/6	114	1263/8	241
1071/5	129	1148/6	116	1229/8	114	1263/9	241
1073/1	130	1148/8	116	1230/1	114	1263/10	241
1073/2	130	1148/9	116	1230/2	114	1263/11	241
1073/3	130	1148/11	116	1231/1	114	1263/12	241
1074/1	191	1148/17	116	1231/2	114	1263/13	240
1074/2	191	1148/19	116	1231/3	114	1263/14	240
1075/1	130	1149/1	126	1233/2	115	1263/15	240
1075/2	130	1149/2	126	1233/3	115	1263/16	240
1080/7	139	1149/7	128	1239/1	115	1263/17	240
1081/4	139	1149/8	128	1243/2	322	1263/18	240
1082/4	158	1150/2	127	1243/3	322	1263/19	240
1084/1	158	1150/5	127	1243/4	322	1263/20	240
1084/2	158	1150/9	122	1243/5	322	1263/21	240
1084/3	191	1150/10	122	1243/7	322	1263/22	240
1084/4	191	1150/12	122	1243/8	322	1263/24	240
1085/1	158	1150/13	122	1243/9	322	1263/25	241
1085/2	158	1151/4	126	1243/10	322	1263/26	241
1089/1	189	1151/5	116	1244/4	323	1263/27	240
1089/3	189	1151/6	116	1244/15	323	1263/29	240
1089/4	189	1151/7	116	1244/20	323	1263/30	240
1090/1	189	1158/8	223	1247/2	113	1263/31	240
1090/3	189	1163/1	334	1251/3	96	1264/1	227
1090/4	189	1163/3	334	1251/4	96	1264/2	227
1091/1	189	1163/4	334	1251/7	96	1264/6	227
1091/2	189	1163/5	334	1251/8	96	1265/5	220
1097/1	139	1163/6	334	1251/9	96	1265/15	221
1097/2	139	1163/7	334	1251/10	96	1265/18	221
1101/1	142	1163/9	335	1251/11	96	1265/26	220
1105/1	139	1164/1	335	1251/12	96	1265/29	221
1111/1	139	1164/2	335	1254/1	236	1265/43	220
1111/2	139	1164/3	335	1254/2	236	1267/6	220

PRODUCT INDEX IN ALPHANUMERIC ORDER - *INDICE PRODOTTI IN ORDINE ALFANUMERICO*

1267/26	220	1308/2	219	1320/23	312	1368/7	21
1267/33	221	1308/2	289	1320/24	312	1368/7/6000	21
1267/48	221	1308/3	219	1320/25	312	1368/7/6000/Z	389
1267/49	221	1308/3	289	1320/27	312	1368/8	21
1268/5	220	1308/4	219	1320/28	312	1368/8	281
1268/6	220	1308/4	289	1320/30	312	1368/8	284
1268/9	220	1308/7	219	1320/31	311	1368/8	284
1268/24	220	1308/7	289	1321/3	311	1368/8	288
1268/33	221	1308/8	219	1321/3	353	1368/8	291
1268/34	221	1308/8	289	1321/4	353	1368/8	291
1268/40	220	1308/9	219	1321/5	353	1368/8/6000	21
1268/50	221	1308/9	289	1321/7	353	1368/8/6000/Z	389
1270/10	226	1308/9/Z	395	1321/7	353	1368/9	21
1274/3	227	1308/10	289	1321/8	353	1368/9	283
1275/1	230	1308/11	219	1321/9	311	1368/9	285
1276/1	229	1308/11	289	1321/9	353	1368/9	299
1279/3	75	1308/12	219	1321/11	311	1368/9	300
1279/4	75	1308/12	289	1321/11	353	1368/9	303
1280/1	76	1309/1	299	1323/1	266	1368/9/6000	21
1280/2	76	1309/4	299	1323/6	264	1368/9/6000/Z	389
1281/1	73	1309/5	299	1323/13	264	1368/10	21
1281/1/5	73	1311/1	65	1324/3	189	1368/10	283
1281/2	73	1311/2	65	1324/4	189	1368/10/6000	21
1281/2/52	73	1311/3	65	1324/5	189	1368/10/6000/Z	389
1281/3	73	1311/4	65	1324/6	189	1368/11	278
1281/3/5	73	1314/1	298	1324/7	189	1368/11	287
1281/4	73	1314/2	298	1324/8	189	1368/11	292
1281/4/52	73	1314/3	298	1324/11	189	1368/11/6000	22
1281/5	72	1315/1	298	1324/12	189	1368/12	22
1281/6	72	1315/2	283	1325/3	198	1368/12	278
1281/7	72	1317/1	310	1325/4	198	1368/12	278
1281/8	72	1317/1	311	1325/5	198	1368/12	279
1281/9	72	1317/2	310	1325/6	198	1368/12	279
1281/10	72	1317/2	311	1325/7	198	1368/12	279
1281/11	72	1317/3	311	1325/8	198	1368/12	280
1281/12	72	1317/3	312	1325/9	198	1368/12	280
1281/14	76	1317/4	311	1325/10	198	1368/12	280
1283/1	300	1317/4	312	1326/1	353	1368/12	284
1283/3	300	1317/5	311	1328/1	342	1368/12	284
1283/4	279	1317/5	312	1328/2	342	1368/12	285
1283/5	279	1317/6	310	1328/3	341	1368/12	286
1283/7	279	1317/7	310	1328/7	343	1368/12	287
1290/1	291	1317/8	310	1328/8	343	1368/12	287
1290/2	291	1317/9	310	1328/9	343	1368/12	292
1291/1	291	1317/10	310	1329/1	342	1368/12	292
1291/2	291	1317/11	310	1329/6	342	1368/12/6000	22
1291/3	291	1317/12	312	1356/2	60	1368/13	22
1291/4	291	1317/13	312	1358/1	61	1368/13	286
1292/3	129	1317/14	312	1358/2	61	1368/13	286
1294/2	285	1317/15	312	1360/1	47	1368/13	287
1294/3	285	1317/16	312	1360/1/Z	391	1368/13	293
1294/6	285	1317/17	312	1360/2	47	1368/13	293
1294/8	285	1317/18	311	1360/2	391	1368/13/6000	22
1294/10	294	1317/19	311	1360/3	47	1368/14	278
1294/11	294	1317/20	311	1360/6	46	1368/14	278
1294/12	294	1317/21	311	1360/6/Z	391	1368/14	279
1294/13	294	1317/22	311	1360/7	47	1368/14	279
1294/14	294	1317/23	311	1360/7/Z	391	1368/14	279
1294/15	294	1317/24	310	1360/8	48	1368/14	280
1295/1	285	1317/25	310	1360/9	48	1368/14	280
1295/2	285	1317/26	311	1360/10	48	1368/14	284
1295/3	285	1317/27	310	1360/11	48	1368/14	285
1295/4	285	1318/2	311	1360/12	54	1368/14	290
1295/5	285	1318/3	311	1360/13	54	1368/14	292
1295/6	285	1318/4	311	1361/1	47	1368/14	298
1295/7	285	1318/5	311	1361/2	47	1368/15	22
1296/5	285	1318/6	311	1361/3	47	1368/15	278
1296/6	285	1318/7	311	1361/4	47	1368/15	292
1296/7	285	1318/8	311	1361/5	47	1368/15	298
1296/8	285	1318/9	311	1361/8	47	1368/15/6000	22
1296/9	285	1318/10	311	1368/1	21	1368/15/6000/Z	389
1296/10	285	1318/11	311	1368/1/6000	21	1368/16	22
1296/11	285	1318/12	311	1368/2	21	1368/16	278
1296/12	285	1318/13	311	1368/2	278	1368/16	290
1296/13	285	1318/15	311	1368/2	290	1368/16	298
1297/1	288	1319/2	311	1368/2	290	1368/16/6000	22
1297/2	288	1319/3	311	1368/2	292	1368/16/6000/Z	389
1297/3	288	1319/6	311	1368/2	303	1368/17	22
1297/12	278	1319/8	312	1368/2/6000	21	1368/17/6000	22
1297/14	278	1319/25	312	1368/3	21	1368/17/6000/Z	389
1297/15	278	1319/27	311	1368/3	278	1368/18	22
1298/1	300	1319/30	311	1368/3/6000	21	1368/18/6000	22
1299/5	311	1320/1	310	1368/3/6000/Z	389	1368/18/6000/Z	389
1299/6	311	1320/2	310	1368/4	21	1368/19	22
1299/7	311	1320/3	310	1368/4	281	1368/19/6000	22
1299/8	311	1320/4	310	1368/4	281	1368/19/6000/Z	389
1300/1	306	1320/5	310	1368/4	282	1368/20	21
1300/2	306	1320/6	310	1368/4	283	1368/20	301
1300/4	306	1320/7	310	1368/4	283	1368/20	305
1301/1	286	1320/8	310	1368/4	287	1368/20/6000	21
1301/2	286	1320/9	310	1368/4	300	1368/20/6000/Z	389
1301/4	286	1320/10	310	1368/4/6000	21	1368/21	21
1301/5	286	1320/11	310	1368/4/6000/Z	389	1368/21/6000	21
1301/10	286	1320/12	310	1368/5	21	1368/22/S	21
1302/1	283	1320/13	312	1368/5	281	1368/22/S/6000	21
1303/1	130	1320/14	312	1368/5	282	1368/22/6000	21
1303/2	130	1320/15	312	1368/5	284	1368/23/6000	21
1303/3	130	1320/16	312	1368/5	287	1368/23/6000/Z	21
1303/4	130	1320/17	312	1368/5	300	1368/23/6000/Z	389
1303/5	130	1320/18	312	1368/5	305	1368/24	21
1303/6	130	1320/19	312	1368/5/6000	21	1368/24/6000	21
1303/7	284	1320/20	312	1368/5/6000/Z	389	1368/24/6000/Z	389
1308/1	219	1320/21	312	1368/6	21	1368/25	21
1308/1	289	1320/22	312	1368/6/6000	21	1368/25/S	21

PRODUCT INDEX IN ALPHANUMERIC ORDER - INDICE PRODOTTI IN ORDINE ALFANUMERICO

1368/25/5/6000	21	1368/72/6000	22	1374/5	28	1385/7	240
1368/25/6000	21	1368/73	22	1374/6	28	1385/7	249
1368/26	21	1368/73	292	1374/7	28	1385/8	240
1368/26/6000	21	1368/73/6000	22	1374/8	28	1385/8	249
1368/27	21	1368/74	22	1374/9	28	1385/9	249
1368/27/6000	21	1368/74/6000	22	1374/9/5	29	1385/11	241
1368/28	21	1368/76	22	1374/10	28	1385/11	249
1368/28/6000	21	1368/76/6000	22	1374/10/52	29	1385/12	249
1368/29	21	1368/77	22	1374/10/53	29	1385/13	240
1368/29/6000	21	1368/77/6000	22	1374/10/54	28	1385/13	249
1368/30	21	1368/78	22	1374/11	28	1385/14	240
1368/30/6000	21	1368/78/6000	22	1374/11/53	29	1385/15	249
1368/31	21	1368/79	22	1374/11/55	28	1385/17	249
1368/31/6000	21	1368/79/6000	22	1374/12	28	1386/1	256
1368/32	21	1368/81	22	1374/12/52	29	1386/2	256
1368/32/6000	21	1368/81/6000	22	1374/13	28	1386/2	256
1368/35	21	1368/82	22	1374/14	28	1386/3	256
1368/35	284	1368/82/6000	22	1374/15	28	1386/4	256
1368/35/6000	21	1368/83	22	1374/16	28	1386/5	253
1368/37	22	1368/83/5/6000/Z	389	1374/17	28	1386/6	253
1368/37/6000	22	1368/83/6000	22	1374/18	28	1386/7	255
1368/39	22	1368/84	22	1374/20	28	1386/8	255
1368/39/6000	22	1368/84/6000	22	1374/21	28	1386/9	255
1368/41	22	1368/85	22	1374/23	28	1386/10	255
1368/41	278	1368/85/6000	22	1374/24	28	1386/11	252
1368/41	278	1368/85/6000/Z	389	1374/25	28	1386/12	252
1368/41	279	1368/86	22	1374/26	28	1386/13	252
1368/41	279	1368/86/6000	22	1374/27	28	1387/2	255
1368/41	279	1368/86/6000/Z	389	1374/29	28	1387/3	255
1368/41	280	1368/88	22	1377/11/T	36	1389/3	320
1368/41	280	1368/88/6000	22	1377/12/T	36	1389/4	320
1368/41	280	1368/90	22	1377/13/T	36	1389/5	320
1368/41	285	1368/90/6000	22	1377/14/T	36	1390/1	330
1368/41/6000	22	1368/90/6000/Z	389	1377/15	30	1390/2	330
1368/43	22	1368/91	22	1377/15/T	36	1390/4	330
1368/43	280	1368/91/6000	22	1377/17/T	36	1390/5	330
1368/43	280	1368/92	22	1377/18/T	36	1391/1	328
1368/43	285	1368/92/6000	22	1377/19/T	36	1391/2	328
1368/43	294	1368/93	22	1377/10/T	36	1391/3	328
1368/43/6000	22	1368/93/6000	22	1377/11	30	1391/4	328
1368/44	22	1368/93/6000/Z	389	1377/14/T	36	1391/4/Z	394
1368/44	283	1368/94	22	1377/15/T	36	1391/5	328
1368/44/6000	22	1368/94/6000	22	1377/16/T	36	1391/5/Z	394
1368/45	22	1368/95	22	1377/17/T	36	1391/6	328
1368/45/6000	22	1368/95	298	1377/18	30	1391/6/Z	394
1368/46	22	1368/95/6000	22	1377/18/T	36	1391/7	328
1368/46/6000	22	1368/96	22	1377/20/T	36	1391/9	328
1368/46/6000/Z	389	1368/96/6000	22	1377/21/T	36	1391/10	328
1368/47	22	1368/97	22	1377/22/T	36	1391/11	328
1368/47/6000	22	1368/97/6000	22	1377/23	30	1391/12	328
1368/47/6000/Z	389	1368/98	22	1377/24	30	1391/14	328
1368/48	22	1368/98/6000	22	1377/40	30	1391/16	328
1368/48/6000	22	1368/99	22	1377/41/T	36	1391/17	328
1368/49	22	1368/99/6000	22	1377/42	30	1391/18	328
1368/49	292	1368/100	22	1377/42/T	36	1391/19	328
1368/49/6000	22	1368/100/6000	22	1378/1	38	1391/20	328
1368/49/6000/Z	389	1368/101	22	1378/2	36	1391/21	328
1368/50	22	1368/101/6000	22	1378/2/5	36	1391/22	328
1368/50/6000	22	1368/102	22	1378/3	38	1391/23	328
1368/51/6000/Z	389	1368/102/6000	22	1378/5	38	1392/1	324
1368/52	22	1368/103	22	1378/5/5	36	1392/2	324
1368/52/6000	22	1368/103/6000	22	1378/6	36	1392/4	325
1368/52/6000/Z	389	1368/106/6000/Z	389	1378/8	38	1392/5	326
1368/53	22	1368/107/6000/Z	389	1378/9	38	1392/6	326
1368/53/6000	22	1368/111/6000/Z	389	1378/10	36	1392/7	326
1368/54	22	1368/113/6000/Z	389	1378/11	36	1393/2	264
1368/54/6000	22	1368/115/6000/Z	389	1378/11/51	36	1393/4	338
1368/54/6000/Z	389	1368/117/6000/Z	389	1378/12	38	1393/5	338
1368/55	22	1369/1/6000	26	1378/13	38	1393/6	338
1368/55/6000	22	1369/2	26	1378/14	38	1393/7	359
1368/56/6000/Z	389	1369/2	279	1378/14/5	36	1393/9	348
1368/57	22	1369/2	283	1378/15	36	1393/10	327
1368/57/6000	22	1369/2	300	1378/16	38	1393/11	327
1368/57/6000/Z	389	1369/2/6000	26	1378/17	38	1393/12	327
1368/58	22	1370/1	39	1378/18	36	1393/13	327
1368/58/6000	22	1370/1/6000	39	1380/1	250	1393/15	327
1368/59	22	1370/2	39	1381/1	250	1393/16	327
1368/59/6000	22	1370/2/6000	39	1381/2	250	1393/18	325
1368/59/6000/Z	389	1370/3	39	1381/3	250	1393/19	325
1368/60	22	1370/3/6000	39	1381/5	250	1393/20	326
1368/60/6000	22	1370/4	39	1381/7	250	1393/21	326
1368/61	22	1370/4/6000	39	1381/8	250	1393/22	326
1368/61/6000	22	1370/11	88	1381/9	250	1393/23	326
1368/62	22	1370/13/6000	24	1381/11	250	1393/25	325
1368/62/6000	22	1370/14	24	1381/12	250	1393/26	325
1368/63	22	1370/14/6000	24	1382/1	235	1393/27	325
1368/63/6000	22	1373/1	39	1382/1	250	1393/28	325
1368/64	22	1373/1/6000	39	1382/2	235	1395/8	316
1368/64/6000	22	1373/2	30	1382/2	250	1395/9	316
1368/65	22	1373/2/6000	30	1382/3	235	1396/1	316
1368/65/6000	22	1373/3	30	1382/3	250	1396/2	316
1368/66	22	1373/3/6000	30	1382/4	235	1396/3	316
1368/66/6000	22	1373/4	30	1382/4	250	1396/5	316
1368/67	22	1373/4/6000	30	1382/5	235	1399/1	259
1368/67/6000	22	1373/4/6000/Z	389	1382/5	250	1400/1	259
1368/69	22	1373/4/6000/Z	390	1382/21	250	1404/1	258
1368/69/6000	22	1374/1	28	1385/1	249	1404/2	258
1368/70	22	1374/2	28	1385/2	249	1404/3	258
1368/70/6000	22	1374/2/51	29	1385/3	249	1404/4	258
1368/70/6000/Z	389	1374/3	28	1385/4	241	1404/6	258
1368/71	22	1374/3/52	29	1385/4	249	1404/7	258
1368/71/6000	22	1374/3/54	29	1385/5	241	1404/8	258
1368/71/6000/Z	389	1374/4	28	1385/5	249	1404/9	258
1368/72	22	1374/4/51	29	1385/6	249	1405/1	361

PRODUCT INDEX IN ALPHANUMERIC ORDER - *INDICE PRODOTTI IN ORDINE ALFANUMERICO*

1405/2	361	1427/21	378	1641/1	270	1705/15	99
1405/3	361	1437/19	383	1641/2	270	1707/1	99
1406/3	339	1438/1	382	1641/3	135	1707/3	99
1408/1	359	1440/1	381	1641/4	135	1707/4	99
1408/2	359	1440/2	381	1641/5	270	1707/5	99
1408/5	358	1443/4	383	1641/6	270	1709/1	100
1408/6	358	1443/13	383	1642/1	269	1709/2	100
1408/7	358	1444/8	382	1647/1	270	1709/3	100
1408/8	358	1444/11	381	1647/3	154	1709/4	100
1408/9	358	1445/1	379	1648/1	269	1709/5	100
1408/10	358	1445/3	379	1648/2	266	1709/6	100
1408/11	358	1445/4	379	1648/3	266	1709/9	100
1408/13	358	1446/1	379	1653/1	265	1709/10	100
1408/14	358	1446/2	379	1657/1	270	1709/11	100
1408/15	358	1446/3	379	1657/2	135	1709/12	100
1408/16	358	1446/4	379	1657/3	135	1709/13	104
1408/17	358	1446/5	379	1657/4	270	1709/15	104
1408/19	358	1446/6	379	1658/1	273	1709/16	104
1408/20	358	1447/5	378	1658/2	273	1709/19	104
1408/21	358	1447/5	378	1659/1	268	1709/20	104
1409/7	353	1447/6	378	1659/2	264	1710/1	99
1409/8	353	1447/6	378	1661/1	267	1710/2	99
1410/7	353	1447/8	378	1661/5	268	1710/4	99
1411/1	353	1447/9	378	1661/9	266	1710/5	99
1411/2	353	1447/10	378	1665/1	305	1710/5	100
1411/3	353	1448/1	379	1665/3	305	1710/6	99
1411/4	353	1448/2	379	1665/4	305	1710/8	99
1411/5	353	1448/4	384	1665/5	305	1710/13	100
1412/1	354	1450/1	385	1665/6	305	1710/16	100
1412/2	354	1450/3	385	1665/7	305	1710/18	100
1412/3	354	1450/4	385	1665/9	305	1710/21	100
1412/4	354	1450/6	385	1665/10	305	1710/22	100
1412/5	354	1450/8	385	1665/11	305	1710/23	100
1412/6	354	1450/9	385	1665/12	305	1710/24	100
1412/7	354	1450/10	385	1665/13	305	1713/1	104
1412/8	354	1451/1	384	1665/14	305	1713/2	104
1412/9	354	1451/3	384	1665/15	305	1713/4	104
1412/10	354	1451/4	384	1665/16	305	1713/5	104
1412/11	354	1451/7	384	1665/17	305	1713/6	104
1412/12	354	1451/9	384	1665/18	305	1713/7	104
1412/13	354	1451/10	384	1665/19	274	1714/1	104
1412/14	354	1452/1	384	1667/1	268	1714/2	104
1412/15	354	1452/3	384	1667/2	268	1714/3	104
1412/16	354	1452/4	384	1667/4	286	1714/4	104
1412/17	354	1452/5	384	1668/2	268	1714/5	104
1412/18	354	1452/6	384	1671/1	145	1714/6	104
1412/19	354	1452/9	385	1671/2	145	1716/1	99
1412/20	354	1452/10	385	1671/3	145	1716/2	99
1412/21	354	1453/1	385	1671/4	145	1716/3	99
1412/22	354	1453/2	385	1671/6	145	1716/4	99
1412/23	354	1453/3	385	1672/1	141	1716/10	99
1412/24	354	1453/4	385	1672/2	141	1716/13	100
1412/26	354	1454/1	385	1674/2	141	1716/14	100
1412/27	355	1454/2	385	1678/2	150	1716/15	100
1412/28	355	1454/3	385	1678/4	134	1716/16	100
1413/1	354	1454/4	385	1680/2	195	1716/18	100
1413/2	354	1454/5	384	1681/1	195	1716/21	100
1413/3	354	1454/9	384	1682/1	201	1716/22	100
1413/4	354	1454/10	384	1685/1	140	1718/2	107
1413/5	354	1454/11	384	1685/2	140	1718/3	107
1413/6	354	1454/12	384	1685/3	207	1718/5	107
1413/7	354	1454/13	385	1688/3	123	1718/6	107
1413/8	354	1454/14	385	1695/1	123	1718/7	107
1413/9	354	1454/15	385	1695/3	123	1718/9	107
1413/10	354	1454/16	385	1695/6	123	1718/10	107
1413/11	354	1463/1	404	1695/7	133	1718/13	107
1413/12	354	1463/5	404	1695/8	133	1718/14	107
1413/13	354	1464/13	398	1695/11	133	1718/16	107
1413/14	354	1464/14	398	1695/12	133	1718/17	107
1413/15	354	1465/15	398	1701/1	100	1718/18	107
1413/16	354	1466/2	403	1701/2	100	1721/1	98
1413/17	354	1466/3	403	1701/3	100	1721/3	98
1413/18	354	1466/4	401	1701/4	100	1721/6	98
1413/19	354	1466/5	401	1701/5	100	1724/1	125
1413/20	354	1466/7	401	1701/6	100	1724/2	125
1413/21	354	1470/8	359	1701/7	100	1724/3	125
1413/22	354	1474/2	366	1701/11	100	1724/4	125
1413/23	354	1474/4	366	1701/12	100	1724/5	125
1413/24	354	1474/7	362	1701/13	100	1724/6	125
1413/25	354	1474/10	362	1701/13	224	1724/7	125
1413/26	354	1475/6	366	1701/14	100	1724/8	125
1414/1	354	1475/7	365	1701/14	224	1724/9	125
1414/2	354	1476/1	365	1701/15	100	1724/10	125
1414/3	354	1476/5	365	1702/1	104	1724/11	125
1414/4	354	1476/7	365	1702/2	104	1724/12	125
1414/5	354	1476/8	365	1702/3	104	1724/13	125
1414/6	354	1476/A/1	364	1702/4	104	1724/14	125
1414/7	354	1476/A/3	364	1702/5	104	1724/15	125
1414/8	354	1476/A/4	364	1702/6	104	1724/16	125
1414/9	354	1476/A/5	364	1702/7	104	1724/17	125
1414/10	354	1476/A/8	364	1702/8	104	1724/18	125
1414/12	354	1476/A/9	364	1702/13	104	1724/19	125
1414/13	354	1476/A/10	364	1702/13	224	1724/20	125
1414/14	354	1476/A/11	364	1702/14	104	1724/21	125
1414/15	354	1476/A/14	364	1702/14	224	1724/23	125
1414/16	354	1476/A/15	364	1702/15	104	1724/24	125
1414/17	354	1476/11	364	1705/1	99	1724/25	125
1414/18	354	1476/12	364	1705/2	99	1724/26	125
1414/19	354	1491/1	330	1705/3	99	1724/27	125
1414/20	354	1491/2	330	1705/4	99	1724/28	125
1414/21	354	1491/3	330	1705/5	99	1724/29	125
1414/22	355	1491/4	330	1705/13	99	1724/30	125
1415/1	57	1491/5	330	1705/13	224	1724/31	125
1415/1/X	57	1639/1	268	1705/14	224	1724/32	125

PRODUCT INDEX IN ALPHANUMERIC ORDER - INDICE PRODOTTI IN ORDINE ALFANUMERICO

1724/33	125	1754/46	250	1764/32	242	1779/13	224
1724/34	125	1754/47	237	1764/33	242	1779/14	100
1724/35	125	1754/47	250	1764/43	242	1779/14	224
1724/36	125	1756/1	237	1764/43	249	1779/15	225
1724/37	125	1756/2	237	1764/44	242	1779/16	225
1724/38	125	1756/14	237	1764/44	249	1780/1	99
1724/39	125	1756/15	237	1764/45	242	1780/1	224
1724/40	125	1756/36	237	1764/45	249	1780/2	224
1724/41	125	1757/1	234	1764/46	242	1780/3	224
1724/42	125	1757/3	234	1764/47	242	1780/4	104
1724/43	125	1757/4	234	1764/48	242	1780/4	224
1724/44	125	1757/5	234	1764/49	242	1780/5	100
1724/46	125	1757/6	234	1764/50	242	1780/5	224
1724/47	125	1757/7	234	1764/51	242	1780/6	100
1724/48	125	1757/8	234	1764/52	242	1780/6	224
1724/49	125	1757/11	234	1764/53	242	1780/7	225
1724/50	125	1757/12	234	1764/54	242	1780/8	225
1724/51	125	1757/13	234	1764/73	242	1780/9	224
1724/52	125	1757/14	234	1764/73	249	1780/11	104
1724/53	125	1757/29	234	1764/74	242	1780/11	224
1724/54	125	1757/30	234	1764/74	249	1780/12	104
1724/55	125	1757/31	234	1764/75	242	1780/12	224
1724/56	125	1757/32	234	1764/75	249	1780/13	100
1724/57	125	1757/33	234	1764/76	242	1780/13	224
1724/58	125	1757/34	234	1764/77	242	1780/14	100
1724/59	125	1757/35	234	1764/78	242	1780/14	224
1724/60	125	1757/39	234	1764/79	242	1782/1	223
1724/61	125	1757/40	234	1764/80	242	1782/5	228
1725/1	125	1757/41	234	1764/81	242	1782/6	226
1725/2	125	1757/42	234	1764/83	242	1782/8	226
1725/3	125	1757/43	234	1764/84	242	1782/9	223
1725/4	125	1757/44	234	1765/8	239	1783/1	218
1725/5	125	1757/45	234	1765/15	239	1783/2	218
1725/6	125	1757/49	234	1765/16	249	1783/3	218
1725/7	125	1757/51	234	1765/21	249	1783/4	218
1725/8	125	1757/52	234	1765/30	239	1783/5	218
1725/9	125	1757/53	234	1765/35	239	1783/6	218
1725/10	125	1757/55	234	1765/41	249	1783/8	218
1725/11	125	1758/1	234	1765/46	249	1784/1	223
1725/12	125	1758/2	234	1765/51	249	1784/2	223
1725/13	125	1758/3	234	1766/3	243	1784/3	223
1725/15	125	1758/4	234	1766/18	243	1784/4	223
1725/18	125	1758/5	234	1766/19	243	1784/5	224
1725/19	125	1758/6	234	1766/24	243	1784/6	224
1725/22	125	1758/7	234	1766/34	250	1784/7/52	224
1725/23	125	1758/8	234	1766/35	250	1784/8	224
1725/24	125	1758/9	234	1766/36	250	1784/9	224
1727/1	105	1758/12	234	1766/37	250	1785/4	228
1727/2	105	1758/13	234	1769/1	82	1787/1	228
1727/3	105	1758/14	234	1769/2	82	1787/9	229
1727/4	105	1758/22	234	1769/3	82	1789/1	228
1727/6	105	1758/23	234	1769/4	86	1789/3	229
1729/1	105	1758/24	234	1769/5	83	1789/4	229
1729/2	105	1758/25	234	1769/6	83	1789/5	228
1729/5	105	1758/26	234	1769/7	87	1793/4	113
1729/6	105	1758/27	234	1769/7	90	1793/5	113
1729/7	105	1758/28	234	1769/8	87	1793/7	323
1729/8	105	1758/32	234	1769/8	90	1794/1	115
1729/11	105	1758/33	234	1770/1	80	1794/2	115
1729/12	105	1758/35	234	1770/2	83	1794/6	115
1730/1	106	1758/36	234	1770/3	83	1794/8	115
1730/2	106	1758/37	234	1770/5	88	1794/9	41
1730/3	106	1758/38	234	1770/6	89	1794/9	115
1730/4	106	1758/42	234	1770/8	87	1794/9/6000	41
1730/6	106	1758/43	234	1770/9	81	1794/9/6000	115
1730/7	106	1758/44	234	1770/10	81	1794/10	41
1730/8	106	1758/45	234	1770/11	86	1794/10	114
1730/9	105	1758/46	234	1770/12	86	1794/10/6000	41
1730/10	105	1758/47	234	1770/13	87	1794/10/6000	114
1730/11	105	1758/48	234	1770/14	87	1802/1	310
1730/12	105	1759/16	237	1770/15	87	1802/2	310
1730/13	105	1759/17	237	1770/16	87	1802/3	310
1730/17	105	1759/18	237	1771/1	80	1802/4	310
1733/3	99	1759/38	237	1771/2	83	1802/5	310
1733/5	104	1759/45	250	1771/3	83	1802/6	310
1733/6	104	1759/46	250	1771/4	82	1802/7	310
1733/9	100	1764/1	242	1771/5	88	1802/8	310
1733/10	100	1764/1	249	1771/8	87	1802/9	310
1733/17	126	1764/2	242	1773/1	90	1802/10	310
1733/19	126	1764/2	249	1773/2	90	1802/11	310
1734/1	103	1764/3	242	1773/5	90	1802/12	310
1734/2	103	1764/3	249	1773/6	90	1802/13	310
1741/3	140	1764/4	242	1775/1	97	1802/14	310
1746/1	109	1764/5	242	1775/3	98	1802/15	310
1746/2	109	1764/6	242	1775/4	97	1802/16	310
1746/3	109	1764/7	242	1775/4	98	1802/17	310
1746/4	109	1764/8	242	1775/6	97	1802/18	310
1746/5	109	1764/9	242	1775/7	105	1802/19	310
1749/1	98	1764/10	242	1775/8	105	1802/20	310
1749/2	98	1764/11	242	1775/11	97	1802/21	310
1749/3	98	1764/12	242	1775/12	97	1802/22	310
1749/4	98	1764/22	242	1777/3	104	1802/23	310
1749/9	96	1764/22	249	1777/4	99	1802/24	310
1749/11	96	1764/23	242	1777/7	100	1802/25	310
1751/5	117	1764/23	249	1777/8	104	1802/26	310
1753/1	121	1764/24	242	1777/9	105	1802/27	310
1753/3	120	1764/24	249	1779/7	225	1802/28	310
1753/4	151	1764/25	242	1779/8	225	1802/29	310
1753/6	120	1764/26	242	1779/9	224	1802/30	310
1753/7	123	1764/27	242	1779/10	224	1802/31	310
1754/16	237	1764/28	242	1779/11	104	1802/33	310
1754/19	237	1764/29	242	1779/11	224	1802/34	310
1754/26	237	1764/30	242	1779/12	104	1802/35	310
1754/45	250	1764/31	242	1779/12	224	1802/36	310

PRODUCT INDEX IN ALPHANUMERIC ORDER - *INDICE PRODOTTI IN ORDINE ALFANUMERICO*

1802/37	310	1807/1	40	1822/1	30	1838/2/6000	26
1802/38	310	1807/2	40	1822/2	30	1838/2/6000	36
1802/39	310	1807/3	40	1822/3	30	1838/3	26
1802/40	310	1807/4	40	1822/5	34	1838/3	36
1802/41	310	1807/5	40	1822/6	30	1838/3/S1	26
1802/42	310	1807/6	40	1822/7	30	1838/3/S2	26
1802/43	310	1807/7	40	1822/9	34	1838/3/S4	26
1802/44	310	1807/8	40	1822/10	34	1838/3/S5	26
1802/46	310	1807/9	40	1822/12	30	1838/3/S6	26
1802/47	310	1807/10	40	1822/13	30	1838/3/S7	26
1802/48	310	1807/11	40	1822/14	30	1838/3/6000	26
1802/49	310	1807/12	40	1822/15	30	1838/3/6000	36
1802/50	310	1807/13	41	1822/16	34	1838/4	26
1802/51	310	1807/14	41	1822/18	30	1838/4	36
1802/52	310	1807/15	41	1822/20	34	1838/4/S1	26
1802/53	310	1807/16	41	1822/21	34	1838/4/S1/L6	26
1802/54	310	1807/17	41	1825/2	37	1838/4/6000	26
1802/55	310	1807/18	41	1825/4	37	1838/4/6000	36
1802/56	310	1807/19	41	1825/5	37	1838/5	26
1802/57	310	1807/20	41	1825/6	37	1838/5/6000	26
1802/58	310	1807/21	41	1825/7	37	1838/6	26
1802/59	310	1807/22	41	1825/8	37	1838/6/6000	26
1802/60	310	1807/23	41	1825/9	37	1838/7	26
1802/61	310	1807/24	41	1825/9	37	1838/7/6000	26
1802/62	310	1808/3	298	1825/10	37	1838/8	39
1802/63	310	1809/5	298	1825/11	37	1838/8/6000	39
1802/64	310	1811/3	301	1825/12	37	1839/1	26
1802/65	310	1811/5	301	1825/13	37	1839/1/6000	26
1802/66	310	1811/8	301	1825/14	37	1839/2	26
1802/67	310	1811/9	301	1825/15	37	1839/2/6000	26
1802/68	310	1811/10	301	1825/16	37	1839/3	26
1802/69	310	1811/11	301	1825/17	37	1839/4	26
1802/70	310	1811/13	300	1825/18	37	1839/4/6000	26
1802/71	310	1813/1	352	1825/19	37	1839/5	27
1802/72	310	1813/3	352	1825/20	37	1839/5/6000	27
1802/73	310	1813/5	352	1825/21	37	1839/6	27
1802/74	310	1813/6	352	1825/22	37	1839/6/6000	27
1802/75	310	1814/2	31	1825/23	37	1839/7	27
1802/76	310	1814/3	31	1825/24	37	1839/7/6000	27
1802/77	310	1814/4	31	1825/25	37	1839/8	27
1802/78	310	1814/5	31	1825/27	37	1839/8/6000	27
1802/79	310	1814/6	31	1825/28	37	1839/9	27
1802/81	310	1814/9	31	1828/1	68	1839/9/6000	27
1802/82	310	1814/10	31	1828/2	68	1839/10	27
1802/83	310	1814/11	31	1828/3	68	1839/10/6000	27
1802/84	310	1814/12	31	1828/4	68	1839/11	27
1802/86	310	1814/14	31	1828/5	68	1839/11/6000	27
1802/87	310	1814/15	31	1828/6	68	1839/12/6000	27
1802/88	310	1814/16	31	1828/7	68	1839/13	27
1802/89	310	1814/17	31	1828/8	68	1839/13/6000	27
1802/90	310	1814/18	31	1828/9	68	1839/14	27
1802/92	310	1817/1	30	1828/10	68	1839/14/6000	27
1802/94	310	1817/1/Z	390	1828/11	68	1839/15	26
1802/96	310	1817/2	30	1828/12	68	1839/15/S/L6	26
1802/97	310	1817/3	30	1828/13	68	1839/15/6000	26
1802/98	310	1817/4	30	1828/14	68	1839/16	26
1802/99	310	1817/5	30	1828/15	68	1839/16/6000	26
1802/100	310	1817/5/Z	390	1828/16	68	1839/17	26
1802/101	310	1817/7	30	1828/17	69	1839/17/6000	26
1802/102	310	1817/7	30	1828/18	69	1839/18	26
1802/103	310	1817/8	30	1828/19	69	1839/18/5	26
1802/104	310	1817/9	30	1828/20	69	1839/18/S2	26
1802/105	310	1817/9/Z	390	1828/21	69	1839/18/S4	26
1802/106	310	1817/9/S5	30	1828/22	69	1839/18/6000	26
1802/107	310	1817/9/XL	32	1828/23	69	1839/18/S6000	26
1802/108	310	1818/1	36	1828/24	69	1839/19/50X6	26
1802/109	310	1818/2	36	1828/29	69	1839/19/6000	26
1802/110	310	1818/3	36	1828/30	69	1839/20	26
1802/111	310	1818/4	36	1828/31	69	1839/20/S1	26
1802/112	310	1818/5	30	1828/32	69	1839/20/S2	26
1802/113	310	1818/7	36	1828/33	69	1839/20/S3	26
1802/114	310	1818/8	36	1828/34	69	1839/20/S3/6000	26
1802/115	310	1818/9	36	1828/35	69	1839/20/S4	26
1803/1	311	1818/10	36	1828/36	69	1839/20/6000	26
1803/2	311	1818/11	36	1834/1	39	1839/20/S6000	26
1803/3	311	1818/11/S	36	1834/1/6000	39	1839/21	26
1803/4	310	1818/12	36	1834/2	39	1839/21/6000	26
1803/5	310	1818/13	36	1834/2/6000	39	1839/22	26
1803/6	310	1818/14	36	1834/3	39	1839/22/6000	26
1803/7	310	1818/15	30	1834/3/6000	39	1839/23	26
1803/8	310	1819/5	30	1834/4	39	1839/23/6000	26
1806/3	25	1819/10	30	1834/4/6000	39	1839/24	26
1806/4	25	1819/13/S	32	1834/5	39	1839/24	291
1806/5	25	1819/14	32	1834/5/6000	39	1839/24/6000	26
1806/6	25	1819/15	32	1834/6/6000	39	1839/25	39
1806/7	25	1819/16	32	1834/7	39	1839/26	26
1806/8	25	1819/17	32	1834/7/6000	39	1839/26/6000	26
1806/9	25	1819/17/S	32	1834/8	39	1841/1	24
1806/10	25	1819/21	32	1834/8/6000	39	1841/2	24
1806/11	25	1819/25	32	1834/9	39	1841/3	24
1806/12	25	1819/29	32	1834/9/6000	39	1841/32	24
1806/13	40	1819/30	32	1837/1	39	1841/34	24
1806/14	40	1820/1	36	1837/1/6000	39	1845/16	48
1806/15	40	1820/2	36	1837/2	39	1845/17	48
1806/16	40	1820/3	36	1837/2/6000	39	1845/18	48
1806/17	40	1820/4	36	1837/3	39	1845/19	48
1806/18	40	1820/7	36	1837/6	39	1845/20	48
1806/20	40	1820/8	36	1837/6/6000	39	1845/21	48
1806/21	40	1820/10	36	1838/2	26	1845/23	48
1806/22	40	1820/11	36	1838/2	36	1845/24	48
1806/23	40	1820/11/XL	34	1838/2/S/3000	26	1845/25	48
1806/25	40	1820/12	36	1838/2/S/6000	26	1845/26	48
1806/27	40	1820/13	36	1838/2/S1	26	1845/27	48
1806/29	40	1820/14	36	1838/2/S1/6000	26	1846/1	61

PRODUCT INDEX IN ALPHANUMERIC ORDER - INDICE PRODOTTI IN ORDINE ALFANUMERICO

1852/1	58	1853/2	51	1853/101	52	1853/203	53
1852/2	58	1853/3	51	1853/102	52	1853/204	53
1852/3	58	1853/4	51	1853/103	52	1853/205	53
1852/4	58	1853/4/S	51	1853/104	52	1853/206	53
1852/5	58	1853/5	51	1853/105	50	1853/207	53
1852/6	58	1853/6	51	1853/105/S1	50	1853/208	53
1852/7	58	1853/7	51	1853/106	50	1853/209	53
1852/8	58	1853/8	51	1853/107	50	1853/210	53
1852/9	58	1853/9	51	1853/108	50	1853/211	53
1852/10	58	1853/10	51	1853/108/S1	50	1853/212	53
1852/11	58	1853/11	51	1853/109	50	1853/214	53
1852/12	58	1853/12	51	1853/110	50	1853/215	53
1852/13	58	1853/13	51	1853/111	50	1853/216	53
1852/14	58	1853/14	51	1853/112	50	1853/217	53
1852/15	58	1853/15	51	1853/113	50	1853/218	53
1852/16	58	1853/16	51	1853/114	50	1853/219	53
1852/17	58	1853/17	51	1853/115	50	1853/220	53
1852/18	58	1853/18	51	1853/116	50	1853/221	53
1852/19	58	1853/19	51	1853/117	50	1853/222	53
1852/20	58	1853/20	51	1853/118	50	1853/223	53
1852/21	58	1853/21	51	1853/119	50	1853/224	53
1852/22	58	1853/22	51	1853/120	50	1853/225	53
1852/23	58	1853/23	51	1853/121	50	1853/226	53
1852/24	58	1853/24	51	1853/122	50	1853/227	53
1852/25	58	1853/25	51	1853/123	50	1853/228	53
1852/26	58	1853/26	51	1853/124	50	1853/229	53
1852/27	58	1853/27	51	1853/125	50	1854/1	326
1852/28	58	1853/28	51	1853/126	50	1854/2	326
1852/30	58	1853/29	51	1853/127	50	1854/3	326
1852/31	58	1853/30	51	1853/128	50	1854/4	261
1852/32	58	1853/31	51	1853/129	50	1854/5	261
1852/33	58	1853/32	51	1853/130	50	1854/6	261
1852/34	58	1853/33	51	1853/131	50	1854/7	248
1852/35	58	1853/34	51	1853/132	50	1854/8	248
1852/36	58	1853/35	51	1853/133	50	1854/9	248
1852/37	58	1853/36	51	1853/134	50	1854/10	248
1852/39	58	1853/37	51	1853/135	50	1855/1	255
1852/40	58	1853/37/S	51	1853/136	50	1855/2	255
1852/41	55	1853/38	51	1853/137	50	1855/3	255
1852/42	55	1853/38/S	51	1853/138	50	1855/4	255
1852/43	55	1853/39	51	1853/139	50	1855/5	255
1852/44	55	1853/40	51	1853/140	50	1855/6	252
1852/45	55	1853/41	51	1853/141	50	1855/7	252
1852/46	55	1853/42	51	1853/142	50	1855/8	252
1852/47	55	1853/43	51	1853/142/S	50	1855/9	252
1852/48	55	1853/45	51	1853/143	50	1855/10	252
1852/49	55	1853/46	51	1853/144	50	1855/11	244
1852/50	55	1853/47	51	1853/144/S1	50	1855/12	244
1852/51	55	1853/48	51	1853/145	50	1855/13	244
1852/52	55	1853/49	51	1853/146	50	1855/14	244
1852/53	55	1853/50	51	1853/147	50	1855/16	244
1852/54	55	1853/51	52	1853/148	50	1855/23	244
1852/55	55	1853/51/S	52	1853/149	50	1855/24	244
1852/56	55	1853/52	52	1853/150	50	1855/25	244
1852/57	55	1853/53	52	1853/151	50	1855/26	244
1852/58	55	1853/54	52	1853/152	50	1857/4	359
1852/59	55	1853/55	52	1853/153	50	1857/5	359
1852/60	55	1853/55/S	52	1853/154	50	1857/6	359
1852/61	55	1853/56	52	1853/155	50	1857/7	359
1852/62	55	1853/57	52	1853/156	50	1857/8	359
1852/63	55	1853/58	52	1853/157	50	1857/13	359
1852/64	55	1853/59	52	1853/158	50	1857/14	359
1852/65	55	1853/60	52	1853/159	53	1857/15	359
1852/66	55	1853/61	52	1853/160	53	1858/1	260
1852/67	55	1853/62	52	1853/161	53	1858/2	260
1852/68	55	1853/63	52	1853/162	53	1858/3	261
1852/69	55	1853/64	52	1853/163	53	1858/4	260
1852/70	55	1853/65	52	1853/164	53	1858/5	261
1852/71	55	1853/66	52	1853/165	53	1858/6	260
1852/72	55	1853/67	52	1853/166	53	1858/7	261
1852/73	55	1853/68	52	1853/167	53	1860/1	358
1852/74	55	1853/69	52	1853/168	53	1860/2	358
1852/75	55	1853/70	52	1853/169	53	1860/3	358
1852/76	55	1853/71	52	1853/170	53	1860/6	358
1852/77	55	1853/72	52	1853/171	53	1861/5	358
1852/78	55	1853/73	52	1853/172	53	1861/8	358
1852/79	55	1853/75	52	1853/173	53	1861/11	358
1852/80	55	1853/76	52	1853/174	53	1861/17	358
1852/81	55	1853/77	52	1853/175	53	1861/20	358
1852/82	55	1853/78	52	1853/176	53	1861/22	358
1852/83	55	1853/79	52	1853/177	53	1867/1	383
1852/84	55	1853/80	52	1853/178	53	1867/3	383
1852/85	55	1853/81	52	1853/179	53	1867/5	383
1852/86	55	1853/82	52	1853/180	53	1869/2	382
1852/87	55	1853/83	52	1853/181	53	1869/5	382
1852/88	55	1853/84	52	1853/182	53	1869/6	381
1852/89	55	1853/85	52	1853/183	53	1869/11	384
1852/90	55	1853/86	52	1853/184	53	1870/1	382
1852/91	55	1853/87	52	1853/185	53	1870/3	382
1852/92	55	1853/88	52	1853/186	53	1871/1	378
1852/93	55	1853/88/S1	52	1853/187	53	1871/5	378
1852/94	55	1853/89	52	1853/189	53	6020/1	284
1852/95	55	1853/90	52	1853/190	53	6020/1	303
1852/96	55	1853/91	52	1853/191	53	6020/3	46
1852/97	55	1853/91/S	52	1853/192	53	6036/9	358
1852/98	55	1853/92	52	1853/193	53	6048/4	47
1852/99	55	1853/93	52	1853/194	53	6096/2	47
1852/100	55	1853/94	52	1853/195	53	6100/1	358
1852/101	55	1853/95	52	1853/196	53	6112/4/S	56
1852/102	55	1853/96	52	1853/197	53	6112/4/S	260
1852/103	55	1853/97	52	1853/198	53	6115/1	283
1852/104	55	1853/98	52	1853/199	53	6258/4	368
1853/1	51	1853/99	52	1853/201	53	F060	360
1853/1/S1	51	1853/100	52	1853/202	53	F061	360

PRODUCT INDEX IN ALPHANUMERIC ORDER - INDICE PRODOTTI IN ORDINE ALFANUMERICO

F062	360	GD106/3	117	GD219/1	202	GD294/2/5	171
F063	360	GD106/5	117	GD220/2	195	GD294/3	171
F064	360	GD106/6	117	GD222/1	179	GD294/3/5	171
F065	360	GD106/7	117	GD222/2	179	GD295/1	176
F066	360	GD106/8	117	GD223/1	179	GD295/2	176
F069	360	GD106/9	117	GD225/1	215	GD296/1	177
GD1	408	GD106/10	117	GD226/3	186	GD296/2	177
GD2	408	GD106/11	117	GD228/1	186	GD297/1	172
GD3	408	GD106/12	117	GD228/2	213	GD297/2	172
GD4	408	GD106/13	117	GD231/1	215	GD298/1	172
GD6	409	GD106/14	117	GD231/2	215	GD298/2	172
GD7	409	GD106/15	117	GD231/2/53	188	GD299/1	166
GD8	409	GD106/17	117	GD232/1	201	GD299/2	166
GD9	409	GD106/18	117	GD234/1	195	GD299/3	166
GD10	409	GD106/19	117	GD235/1	211	GD299/4	166
GD11	409	GD106/20	117	GD236/1	206	GD299/4	271
GD12	408	GD106/21	117	GD239/1	206	GD300/1	187
GD12/1	194	GD106/22	117	GD239/5	339	GD300/2	187
GD13	410	GD106/23	117	GD241/1	205	GD300/3	187
GD14	410	GD106/24	117	GD242/1	201	GD301/1	165
GD15	409	GD106/26	117	GD243/1	161	GD301/2	165
GD15/1	194	GD106/27	117	GD243/2	159	GD301/3	165
GD15/2	194	GD124/19	24	GD245/1	205	GD301/4	165
GD16	408	GD124/20	24	GD245/2	205	GD301/5	165
GD16/1	194	GD124/21	24	GD245/3	203	GD302/1	168
GD16/2	194	GD124/23	24	GD247/1	175	GD302/2	168
GD17	408	GD124/24	24	GD248/1	86	GD302/3	168
GD18	408	GD124/25	24	GD248/2	86	GD303/1	169
GD18/1	194	GD124/26	24	GD248/4	86	GD303/2	169
GD18/2	194	GD124/27	24	GD255/1	183	GD303/3	169
GD18/3	194	GD124/28	24	GD262/3	293	GD305/1	161
GD18/4	194	GD124/31	24	GD262/4	293	F0181	360
GD19	409	GD124/32	24	GD263/1	293	F0222	361
GD19/1	159	GD124/33	25	GD263/3	293	F0223	361
GD19/2	159	GD124/34	25	GD264/1	293	F0631	360
GD19/4	161	GD124/35	25	GD264/3	293	F0681	360
GD20	409	GD128/20	53	GD264/5	293	F0682	360
GD20/1	196	GD148/1	209	GD264/5	293	F02231	361
GD20/2	196	GD150/2	209	GD268/1	268	F06910	360
GD20/3	196	GD150/3	209	GD268/2	269	F06911	360
GD20/4	196	GD151/1	209	GD269/1	270	F06912	360
GD20/5	196	GD151/2	272	GD269/3	270	F06913	360
GD20/6	196	GD154/3	212	GD271/1	76	F06920	360
GD20/7	196	GD158/1	212	GD271/2	76	F06921	360
GD20/8	196	GD158/2	212	GD271/3	76	F06922	360
GD21	408	GD159/1	204	GD271/4	215	F06923	360
GD21/1	197	GD159/2	204	GD271/5	215	F011976	361
GD21/2	197	GD163/1	202	GD273/2	108	F083500	360
GD21/3	197	GD163/2	202	GD273/4	108	F083510	360
GD21/4	197	GD164/1	210	GD273/5	108	F083520	360
GD21/5	197	GD164/2	210	GD273/6	108	F083610	360
GD22	409	GD166/2	213	GD273/9	224	F083620	360
GD22/1	207	GD170/1	180	GD273/10	224	F085500	360
GD22/5	203	GD170/2	180	GD274/1	108	F085510	360
GD22/6	117	GD171/1	191	GD274/2	108	F085600	360
GD23	408	GD173/1	204	GD274/3	108	F085610	360
GD23/1	159	GD175/4	208	GD274/4	108	F085700	360
GD24	409	GD175/5	208	GD274/5	108	F085710	360
GD25	408	GD175/6	208	GD274/6	108	F085720	360
GD25/1	159	GD175/7	212	GD274/9	224	GDS17FB	176
GD25/2	161	GD176/1	180	GD274/10	224	GDS20FB	176
GD25/3	159	GD176/2	180	GD274/11	108	NEW0049	359
GD26	410	GD176/3	180	GD275/1	109	NEW0050	359
GD27	408	GD177/1	213	GD275/2	109	NEW0059	343
GD28/1	182	GD177/2	214	GD275/3	109	NEW0066	286
GD28/2	182	GD178/1	203	GD275/7	109	NEW0069	286
GD28/3	182	GD179/1	174	GD275/8	109	NEW0071	286
GD29/2	161	GD179/2	174	GD275/9	109	NEW0077	65
GD31/1	201	GD181/1	160	GD278/1	161	NEW0078	65
GD31/2	201	GD181/2	160	GD278/2	161	NEW0079	66
GD35/1	200	GD181/3	160	GD280/2	213	NEW0080	66
GD35/2	200	GD182/1	160	GD282/1	214	NEW0081	66
GD35/3	200	GD182/2	160	GD282/2	207	NEW0082	66
GD39/1	210	GD183/1	160	GD283/1	195	PT30X4/ZINC/LAM	389
GD39/2	175	GD184/1	160	GD283/2	214	PT35X5/ZINC/LAM	389
GD39/3	210	GD184/2	160	GD283/4	214	PT40/5/ZINC/LAM	389
GD45/1	175	GD186/1	181	GD284/2	214	PT60/5/ZINC/LAM	389
GD45/2	175	GD186/2	181	GD285/1	188	ANG20X3/ZINC/LAM	389
GD47/1	174	GD186/3	181	GD285/2	72	ANG25X3/ZINC/LAM	389
GD47/3	174	GD187/1	190	GD285/2	188	ANG25X4/ZINC/LAM	389
GD58/1	203	GD187/2	190	GD285/2/5	72	ANG25X5/ZINC/LAM	389
GD58/2	159	GD187/2	267	GD285/5	188	ANG30X3/ZINC/LAM	389
GD58/3	159	GD189/1	190	GD286/1	188	ANG30X4/ZINC/LAM	389
GD59/2	159	GD189/2	190	GD287/1	164	ANG30X5/ZINC/LAM	389
GD59/2/Q14	159	GD202/1	163	GD287/2	164	ANG35X3/ZINC/LAM	389
GD59/3	203	GD202/2	163	GD287/3	164	ANG35X5/ZINC/LAM	389
GD61/1	200	GD202/3	181	GD287/4	164	ANG40X4/ZINC/LAM	389
GD61/3	203	GD202/4	163	GD288/1	171	ANG40X5/ZINC/LAM	389
GD67/1	174	GD202/5	181	GD289/1	170	ANG50X5/ZINC/LAM	389
GD68/1	199	GD205/1	192	GD289/1/5	170	ANG60X6/ZINC/LAM	389
GD69/1	213	GD205/2	192	GD289/2	170	PL40X20X4/ZINC/LAM	389
GD72/1	182	GD206/1	215	GD289/2/5	170	PL50X30X5/ZINC/LAM	389
GD73/1	182	GD209/1	192	GD290/1	173	PL60X40X5/ZINC/LAM	389
GD76/2	193	GD211/1	199	GD290/2	173	FLAMB200100/20/Z	392
GD78/4	191	GD211/2	199	GD291/1	192	FLAMB200100/25/Z	392
GD78/6	191	GD211/2	267	GD291/2	185	FLAMB200100/30/Z	392
GD92/2	183	GD211/3	199	GD293/1	162	FLAMB250125/20/Z	392
GD92/3	183	GD212/1	199	GD293/3	170	FLAMB250125/25/Z	392
GD99/1	202	GD212/2	178	GD293/3/5	170	FLAMB250125/30/Z	392
GD105/1	207	GD212/3	178	GD294/1	171	FLAMB300150/30/Z	392
GD106/1	117	GD216/1	205	GD294/1/5	171		
GD106/2	117	GD216/2	205	GD294/2	171		



Il catalogo, comprese tutte le sue parti, è tutelato dalla legge sui diritti d'autore. Sono vietate e sanzionate (se non espressamente autorizzate) la riproduzione in ogni modo e forma (comprese le fotocopie, la scansione, la memorizzazione elettronica) e la comunicazione (ivi inclusi a titolo esemplificativo ma non esaustivo: la distribuzione, l'adattamento, la traduzione e la rielaborazione, anche a mezzo di canali digitali interattivi e con qualsiasi modalità attualmente nota od in futuro sviluppata)

The catalogue, including all its parts, is under copyright law. Any reproduction in any way and form (including photocopies, scans, electronic storages) and communication (including for example: the distribution, the adjustment, the translation and the revision, also through digital interactive channels and any other mode currently known or developed in future) is forbidden and sanctioned (if not clearly authorised).



Ci riserviamo il diritto di apportare variazioni tecniche di fabbricazione e di dimensioni ai prodotti. I prodotti originali possono differire leggermente dalle rappresentazioni fotografiche. A questo proposito non sarà accettato nessun reclamo.

We reserve the right to make technical changes of the production process and of the article's dimensions.

The original item can slightly differ from its picture. Hence no claims can be accepted in this regard.



IAM Design declina ogni responsabilità giuridica non legalmente prevista per eventuali errori di stampa.

IAM Design disclaims any legal liability not legally foreseen for printing mistakes



La somma massima prevista per i risarcimenti è rappresentata dal valore della merce integra.

The max reimbursement amount foreseen as claim for damages is to be referred to the value of intact goods



Si prega di osservare le direttive legali applicabili nelle varie regioni/nei vari paesi.

You are kindly requested to observe the directives applied in the different areas/countries.



I prezzi indicati sono netti per unità, imballaggio incluso. Tutti i prezzi sono IVA esclusa.

The prices are net per unit, packaging included. All prices are exempt of VAT.



Per ogni articolo è prevista una confezione minima indicata a listino. Eventuali ordini per quantità che differiscono dalla confezione minima o a multipli di essa, potranno essere automaticamente adeguati dall'azienda senza previa autorizzazione.

For each item a minimum packaging unit is foreseen, as indicated in the price-list. In case of orders with different quantities than those of the minimum packaging or multiple of it, the company can adjust them automatically without prior authorisation.



Si applicano le nostre condizioni generali di vendita
Our general sales conditions will be applied

Le condizioni di vendita le potete trovare sul sito

Our sales conditions can be read in our website

Condiciones de venta en nuestro catálogo

Conditions de vente dans notre catalogue

www.gonzatogroup.com/sales_conditions.html

HEADQUARTER

GONZATO GROUP ITALY

Ind.i.a. spa
Via Vicenza, 6/14
36034 - Malo
Vicenza - Italia
T. +39 0445 580 580
F. +39 0445 580 874
info@gonzato.com
www.gonzato.com

GONZATO GROUP SPAIN

Ind.i.a. España, SL
C/ Abedul, 43 – Polig. Ind. El Guijar
28500 - Arganda del Rey
Madrid • España
T. +34 918 700 819
F. +34 918 700 820
info@arterferro.es
www.gonzato.com

GONZATO GROUP ARGENTINA

Arteferro Argentina SA
Suárez 760,
1162 Buenos Aires • Argentina
T. +54 11 4301 2637
F. +54 11 4301 2637
info@arterferroargentina.com
www.gonzato.com

GONZATO GROUP USA-HOUSTON

Indital US Ltd
7947 Mesa Drive
77028 - Houston
Texas • U.S.A.
T. +1 713 694 6065
F. +1 713 694 2055
forgings@indital.com
www.gonzato.com

GONZATO GROUP CROATIA

Arteferro Gorican d.o.o.
Gospodarska ulica 1°
40324 Goričan – Međimurje
T. +385 (0) 40 602 222
F. +385 (0) 40 602 230
info@arterferro-dohomont.hr
www.gonzato.com

GONZATO GROUP CHILE

Arteferro Chile SA
Calle Los Arrayanes, 250, bodega 4
9340000 -Santiago
Colina • Chile
T. +56 2 738 7419
F. +56 2 738 7419
arterferro@arterferrochile.cl
www.gonzato.com

GONZATO GROUP USA-MIAMI

Arteferro Miami LLC
2955 NW 75th Street
33147 - Miami
Florida • U.S.A.
T. +1 305 836 9232
F. +1 305 836 4113
info@arterferromiami.com
www.gonzato.com

GONZATO GROUP ROMANIA

S.C. Arteferro Braila S.A.
Chiscani, Vizirului Street, Km 10
Braila • Romania
T.+ 40 004 0239 652 854
arterferrocont@gmail.com
www.gonzato.com

GONZATO GROUP CHINA

Gonzato (Qingdao) Decoration Co., Ltd
Office 108/109
No. 10 South Building
No. 130 Tianlin Road
Xuhui District, Shanghai
T. +86 13708959259
www.gonzato.com

GONZATO GROUP USA-LOS ANGELES

Gonzato Group CA, INC.
3483 Chicago Avenue
Riverside, CA 92507
California • USA
T. +1 951 465 7225
info@gonzatogroup.us
www.gonzato.com

GONZATO GROUP RUSSIA

ООО "АРТЕФЕРРО-РУССИЯ"
603124, Россия, Нижний Новгород,
Вторчермета 1Г
Тел. +7-831-2621999
info@arterferrorussia.com
www.gonzato.com

GONZATO GROUP BRAZIL

Ind.i.a. Brasil LTDA
Rua Padre Feijó, 480
95190-000 - São Marcos
Rio Grande do Sul • Brasil
T. +55 54 3291 1416
F. +55 54 3291 1416
Branch
Av. Almirante Cochrane, 194 – Sala 32
11040-200 – Santos - Sao Paulo • Brasil
T. +55 13 21389091
vendas@arterferrobrasil.com.br
www.gonzato.com

GONZATO GROUP FRANCE

Ind.i.a. France Sarl
P.A.E. la Baume, 7 Rue de l'Artisanat
34290 - Servian
Servian • France
T. +33 (0) 4 67 39 42 81
F. +33 (0) 4 67 39 20 90
info.france@gonzato.com
www.gonzato.com

GONZATO GROUP MEXICO

Arteferro Monterrey SA de CV
Privada la Puerta 2879 B-4
66350 - Col. Parque Industrial
La Puerta Santa Catarina
Nuevo Leon • México
T. +52 1 81 1295 5094/95
F. +52 1 81 1295 5097
info@arterferromexico.com
www.gonzato.com



arterferro.com



You
Tube



GONZATO
GROUP

Arteferro is a brand of Gonzato Group
Via Vicenza, 6/14 (SP46) - 36034 Malo (Vicenza) Italy / T +39 0445 580 580 - F +39 0445 580 874
info@arterferro.com - arteferro.com