



arteferro[®]
italian wrought iron

QUICK



IT
EN

- LONG BARS
BARRE LUNGHE
- PIERCED BARS
SHAPED BARS
BARRE FORATE
BARRE SAGOMATE
- OVERTHROWS
CIMASE
- CLASSICAL PICKETS
AND PANELS
PALETTI E PANNELLI
CLASSICI
- MODERN PICKETS
AND PANELS
PALETTI E PANNELLI
MODERNI
- BOWED PICKETS
PANCIONI
- PICKETS FOR FENCING
PALETTI PER RECINZIONE
- SPEAR POINTS
AND POST TOPS
LANCE, POMOLI E
TERMINALI A COLONNA
- ROSACES
ROSONI
- RINGS
CERCHI
- SCROLLS AND
SNAP-ONS
RICCI E SNAP-ONS
- SPHERES
SFERE
- BUSHES
BORCHIE
- BASKETS
PIGNE
- FLOWERS AND
ROSETTES
FIORI E ROSETTE
- DECORATIONS IN
STEEL SHEET
DECORI IN LAMIERA
- PLATES AND
ACCESSORIES
PIASTRE E
ACCESSORI
- TOOLS
UTENSILI

Vol.
04





arteferro® QUICK

italian wrought iron

Arteferro Quick is the new catalogue dedicated to a special selection of Arteferro items, extracted from the well-known Compendium Ind.i.a.

We've called Arteferro "Quick" because its quick and easy to use, thanks to the improved organisation of products, which has been supplemented with a lot of useful technical information.

Arteferro Quick è il nuovo catalogo dedicato ad una speciale selezione di articoli Arteferro, estratta dal noto Compendium Ind.i.a.

L'abbiamo chiamato Arteferro "Quick" proprio perché è veloce e rapido da utilizzare, grazie alla migliorata organizzazione dei prodotti, arricchita con molte informazioni tecniche utili.



Copyright © 2018 Ind.i.a. spa. Tutti i diritti riservati. Domanda di marchio, design o brevetto depositata/ registrazione o brevetto rilasciato in uno o più paesi.
Per ulteriori informazioni, non esitate a contattarci a info@arteferro.com.
Copyright © 2018 Ind.i.a. spa. All rights reserved. Trademark, design or patent application pending/ registration or patent granted in one or more countries.
For additional information, please contact us at info@arteferro.com.



Arteferro is a division of Ind.i.a. Spa dedicated to the production of semi-finished elements in wrought iron, brass and bronze. The Arteferro product line includes over 32,000 semi-finished ornamental items made of wrought iron, brass, and bronze: pierced bars, forged pickets, pre-assembled panels, leaves, flowers, baskets, roses, scrolls, rings, and other decorative elements, as well as a rich variety of home furnishings. It is the task of blacksmiths to assemble them into finished objects such as railings, fences, or any other creation suggests his creativity. Arteferro also includes the **Gonzato Design** product line, which is characterized by an elegant and innovative style.

Arteferro è la divisione di **Ind.i.a. spa** dedicata alla produzione di elementi semilavorati in ferro battuto, ottone e bronzo. La gamma di prodotti Arteferro comprende oltre 32.000 elementi: barre forate, paletti forgiati, pannelli preassemblati, foglie, fiori, pigne, rosoni, ricci, cerchi ed altri componenti decorativi, oltre ad una ricca serie di complementi d'arredo. Sarà compito del fabbro assemblarli in oggetti finiti come parapetti, recinzioni o qualsiasi altra creazione gli suggerisca la sua creatività. Arteferro comprende anche la linea di prodotti **Gonzato Design**, caratterizzata da uno stile elegante ed innovativo.

THE BEST IN WROUGHT IRON IL MEGLIO DEL FERRO BATTUTO



A small, but massive revolution!

una piccola grande rivoluzione!

The **Arteferro Quick** catalogue has been specifically organised to facilitate the search for individual items. First of all, the **structural elements**, like long bars, pierced bars and overthrows, then **filling elements**, like pickets, panels and rosettes, and then passing onto **decorative elements** like scrolls, circles, spheres and many others. At the end, you'll find the **accessories** and **tools** for construction site activities.

Il catalogo **Arteferro Quick** è stato organizzato appositamente per agevolare la ricerca di ogni elemento. Prima gli **elementi strutturali**, come le barre lunghe, le barre forate e le cimase, poi gli **elementi di tamponamento**, come i paletti, i pannelli, rosoni, per passare agli **elementi decorativi** come i ricci, i cerchi, le sfere e molti altri. Infine si troveranno gli **accessori** e gli **utensili** per l'attività di cantiere.

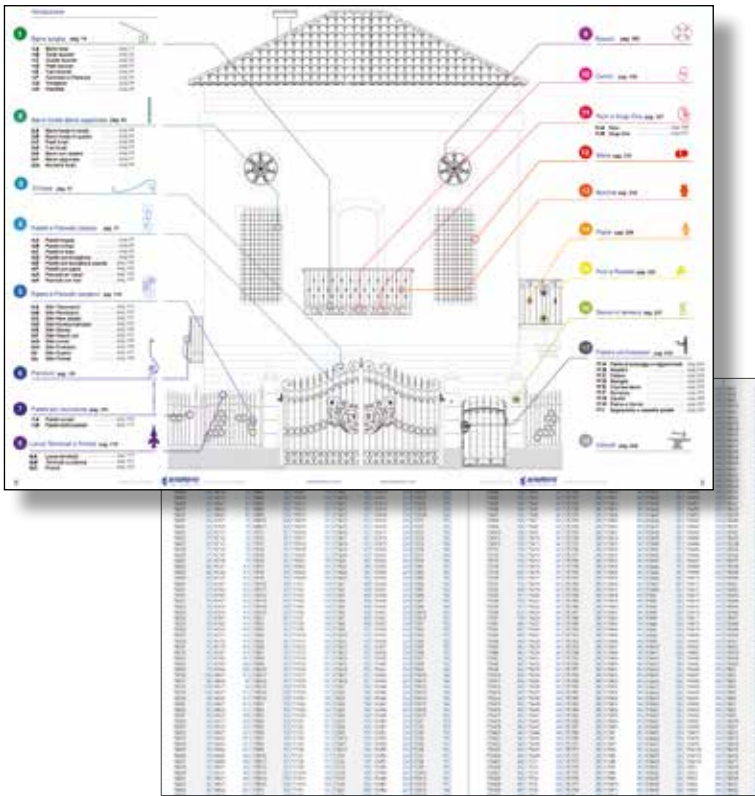

Find what you're looking for straight away

In addition to an **index by product code**, which is easy for loyal customers who know well our elements, we have created a new index by type of product, which makes any search fast and intuitive. In fact, every product line has been organised into sections and, for the most complex ones, specific sub-sections have been created, based on the processing, cross-sections, styles and types of element. To improve the consultation process, some sections have been reorganized and, among these, the section dedicated to **posts** has been integrated into the one for pickets and panels.

Trovi subito quello che cerchi

Oltre all'**indice per codice prodotto**, facile da consultare da tutti i nostri affezionati clienti che ben conoscono i nostri articoli, abbiamo ideato un nuovo **indice per tipologia di prodotto**, che rende ogni ricerca rapida ed intuitiva. Ogni linea di prodotto infatti è stata organizzata in capitoli e, per le più articolate, sono stati creati degli appositi sotto capitoli in base alla lavorazione, alla sezione, allo stile, alla tipologia degli elementi. Per una miglior consultazione sono stati riorganizzati alcuni capitoli e, tra questi, quello dedicato ai **capisaldi** è stato integrato in quello dei paletti e pannelli.

New products

Our designers are always at work! In Arteferro Quick, you'll find many new articles highlighted with a specific seal. With a classic or modern design, they're always characterized by the unique and unmistakable Arteferro style.

Nuovi prodotti

I nostri designer sono sempre all'opera! In Arteferro Quick troverai tanti nuovi articoli evidenziati dall'apposito bollino. Dal design classico o moderno sono comunque sempre caratterizzati dallo stile Arteferro, unico ed inconfondibile.

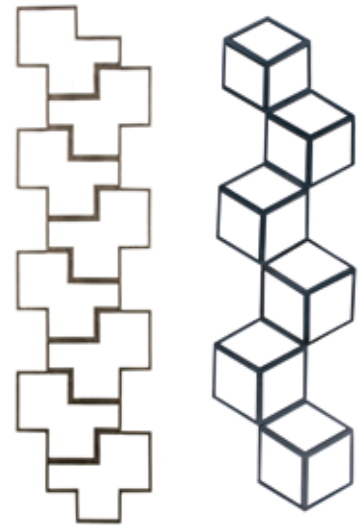

Easy to flip through

At the beginning of each section, on the focused cover, a description helps understand its content. Thanks to the renewed graphics it will be very easy to find the item you are looking for. In the more complex sections easy instructions will help you to better understand how they are organised.

Facile da sfogliare

All'inizio di ogni capitolo, sulla copertina dedicata, un testo descrittivo aiuta a capire cosa troverai all'interno. Grazie alla grafica rinnovata sarà un gioco da ragazzi individuare l'articolo che ti interessa. Nei capitoli più complessi abbiamo riportato delle facili istruzioni che ti aiuteranno nel comprendere la logica dell'organizzazione.



Amongst the pages, a huge amount of useful information

Created afresh, based on over forty years of experience in the industry, **Arteferro Quick** wants to become a really easy to use and intuitive work tool for you to consult, by virtue of its new logical layout, which enables you to find the product of interest straight away, to pass quickly from one family of articles to another, and then to go into the details with sizes and finishes.

Tra le pagine molte informazioni utili

Realizzato ex novo, sulla base di un'esperienza ultra quarantennale nel settore, **Arteferro Quick** vuole diventare un vero e proprio strumento di lavoro facile ed intuitivo da consultare, in virtù della nuova ragionata impaginazione che consente di trovare immediatamente il prodotto di interesse, passando celermente tra le famiglie di articoli, per poi entrare nel dettaglio con il dimensionamento e le finiture.

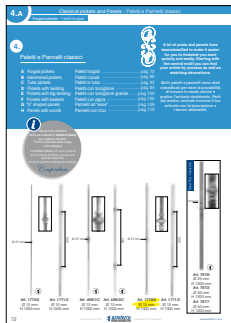

4. Classical pickets and Panels
Paletti e Pannelli classici

| | | |
|-----------------------------|--------------------------------|----------|
| A Forged pickets | Paletti forgiati | pag. 72 |
| B Hammered pickets | Paletti conati | pag. 80 |
| C Tube pickets | Paletti in tubo | pag. 82 |
| D Pickets with twisting | Paletti con torciglione | pag. 94 |
| E Pickets with big twisting | Paletti con torciglione grande | pag. 100 |
| F Pickets with baskets | Paletti con pigna | pag. 102 |
| G "S" shaped panels | Pannelli ad "esse" | pag. 105 |
| H Panels with scrolls | Pannelli con ricci | pag. 110 |

A lot of pickets and panels have been classified to make it easier for you to find what you want quickly and easily. Starting with the central motif, you can find your article by process as well as matching decorations.

Molti paletti e pannelli sono stati classificati per dare la possibilità di trovare in modo veloce e pratico l'articolo desiderato. Parti dal motivo centrale troverai il tuo articolo con la lavorazione e i decori abbinabili.

Starting Section box

A quick overview about how to deal with the specific section

Riquadro di inizio capitolo

Rapida panoramica su come affrontare il capitolo specifico

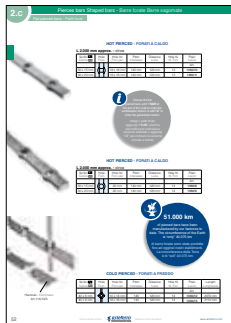

51.000 km

of pierced bars have been manufactured by our factories to date. The circumference of the Earth is "only" 40,075 km

di barre forate sono state prodotte fino ad oggi nei nostri stabilimenti. La circonferenza della Terra è di "soli" 40.075 km

Blue Circle

useful and interesting information about our elements.

Cerchio blu

notizie utili e curiosità sui nostri articoli

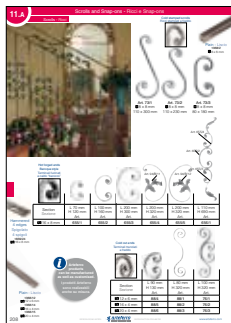

i Arteferro products can be manufactured as well as customised.

I prodotti Arteferro sono realizzabili anche su misura.

Grey Circle

technical information and stylistic advice from our experts

Cerchio grigio

informazioni tecniche e consigli stilistici dei nostri esperti



Highlights

identify the featured articles

Highlights

identifica gli articoli in evidenza



Articles of the Gonzato Design line
articoli della linea Gonzato Design



new items
articoli nuovi



items that are the intellectual property of Ind.i.a. spa
articoli di proprietà intellettuale di Ind.i.a. spa



special price items
articoli a prezzo speciale

Gonzato Design è la linea di prodotti Arteferro caratterizzata da uno stile innovativo. I motivi classici del ferro battuto si fondono e dialogano con le geometrie moderne dando vita ad un insieme unico che parla di passato e futuro. Le linee in stile Classico di inizio '900 sono mediate con una sensibilità contemporanea che razionalizza lo spazio e lo rende elegante e preciso.

Tra gli articoli Gonzato Design anche i **pannelli pre-assemblati** che, pronti per l'installazione, sono pensati per facilitare il lavoro dell'artigiano: basta unirli tra loro o accoppiarli a dei semplici paletti di ferro liscio per realizzare la propria composizione. Una soluzione di design e pratica che consente un notevole risparmio di tempo e denaro. Come tutti i prodotti Arteferro anche i pannelli pre-assemblati possono esser prodotti anche **anche su misura**.

The **Gonzato Design** product line by Arteferro is set apart by its innovative style. The classical wrought iron motifs interact with modern geometry, creating a unique combination of past and future. The lines, inspired by the Classic style of the early 1900s, are mediated with a contemporary awareness, rationalising space and making it elegant and precise.

The Gonzato Design range also includes **preassembled panels**, ready for installation, designed to facilitate the work of the craftsman: just join them together or connect them to simple plain iron pickets to make your own arrangement. A practical design solution that allows for considerable savings in terms of both time and money. Like all Arteferro products, the pre-assembled panels can also be custom-made.



**GONZATO
DESIGN**
FINE WROUGHT
IRON FORGINGS

The Gonzato Design product line by Arteferro has been expanded with many new items and combined together into families: Geometric, Revolution, New Waves and much more to be discovered!

La linea di prodotti Gonzato Design by Arteferro è stata ampliata con tanti nuovi articoli e raggruppati in famiglie: Geometric, Revolution, New Waves e tante altre tutte da scoprire!

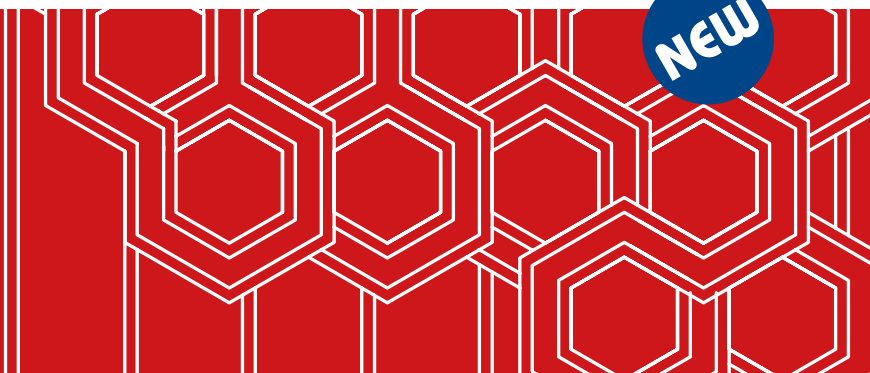

Why choose the Gonzato Design products? Perché scegliere i prodotti Gonzato Design?



Exclusive and patented design
Design esclusivo e brevettato



Welding and production quality
Saldature e lavorazioni di alta qualità



Easier and quicker installation than traditional pickets
Installazione più facile e più veloce rispetto ai classici paletti



High value-added to your final product
Alto valore aggiunto al tuo manufatto finale



Excellent value for money
Eccellente rapporto qualità-prezzo



Ideal for installations in modern contexts
Ideale per installazioni in contesti moderni

Discover more about Gonzato Design line, visit - Scopri di più sul mondo Gonzato Design visita
www.gonzatodesign.com





With 20 companies spread throughout the world, Gonzato Group is the leader in production of semi-finished products and modular systems in metal for construction and architecture. Its products, distributed in 136 countries, have been chosen to protect and adorn some of the most important buildings in the world, including: the palace of Justice and the Colosseum in Rome, the park Terenure in Dublin, Disneyland in Paris, and many other prestigious villas and residences in St.Petersburg, passing through London, Beijing, and Saint Tropez.

Con 20 società, sparse in tutto il mondo, Gonzato Group è leader nella produzione e distribuzione di semilavorati e sistemi modulari in metallo per l'edilizia e l'architettura. I suoi prodotti, distribuiti in 136 paesi, sono stati scelti per proteggere ed adornare alcuni dei più importanti edifici e complessi mondiali, tra i quali il palazzo di Giustizia ed il Colosseo di Roma, Il parco Terenure di Dublino, Disneyland a Parigi e molte altre prestigiose ville e residenze da Hollywood a San Pietroburgo, passando per Londra, Pechino e Saint Tropez.



A company looking towards the future.

Since 1971, we are world leader in the production and sale of ornamental components for the building industry and architecture. All our products are the result of careful and passionate research by qualified experts that know the field better than anyone else. In fact, it is thanks to the Group's work in the production of metal elements for architecture and constructions has been able to grow in terms of technology and project management to become what it is now.

The experience acquired in over 40 years of work in the field of wrought iron allowed us to develop in the last 15 years the same deep knowledge in the field of stainless steel and of its fencing applications. As a matter of fact, our IAM Design line, while being more technical and stylized compared to the Arteferro components, meets the same needs of safety, support and decoration that we have always well known.

In the Group's catalogues you will find more than 30.000 fencing and furniture components always ready to use and ready to be dispatched. Thanks to our long experience, that involves all the production and supply chain from product design to manufacturing, to the installation support, we are the sole company in the world who is able to realize and install anywhere big fencing structures, relying upon our know how and the practical sense of our designers and members of our team.

Un'azienda rivolta al futuro.

Dal 1971 siamo leader mondiali nella produzione e commercializzazione di semilavorati ornamentali per l'architettura. Tutti i prodotti sono frutto di studi attenti ed appassionati da parte di professionisti specializzati che conoscono il settore meglio di chiunque altro. Infatti è grazie alla attività del Gruppo che la produzione nel settore ha potuto svilupparsi tecnologicamente e progettualemente fino a diventare quel che è oggi.

L'esperienza maturata in oltre 40 anni di ferro battuto, ha consentito di sviluppare un altrettanto approfondita conoscenza dell'acciaio inox e dei suoi utilizzi nella recinzione. IAM Design, propone soluzioni più tecniche e stilizzate, mentre i manufatti in ferro battuto di Arteferro hanno caratteristiche di maggiore varietà ornamentale ma entrambe le linee di prodotti assolvono sempre a quelle stesse esigenze di protezione, sostegno e decorazione che ben conosciamo da sempre.

Nei cataloghi del Gruppo sono presenti oltre 32.000 manufatti per recinzioni ed arredamento, sempre pronti all'uso ed alla consegna. Grazie a questa esperienza pluridecennale che coinvolge tutta la filiera dalla produzione siderurgica, al design dei prodotti, alla loro realizzazione, all'installazione, siamo anche gli unici al mondo capaci di ideare con architetti e sviluppatori oltre che di realizzare ovunque grandi opere, forti del know how e della praticità dei nostri progettisti e operatori.

World market leader

- a 5 continents' leadership
- exports to 136 countries
- a product range of over 32,000 items

Certifications

- ISO 9001 - Quality Management
- ISO 14001 - Environmental Management

Leader di mercato

- leadership nei 5 continenti
- presenza in 136 stati
- gamma di oltre 32.000 articoli

Certificazioni

- ISO 9001 - Gestione della Qualità
- ISO 14001 - Gestione Ambientale

An ever growing presence

- 20 companies in 5 continents and headquarter in Italy
- 4 production sites totalling
- 64.000 m² of warehousing and production.
- Over 700 employees and collaborators
- 4.100 ton./month shipped
- 40 million pieces of ready made components sold per year
- Over 2000 stockist customers served, in 136 different Countries
- Over 32,000 components available on stock

Una realtà in continua crescita.

- 20 aziende in 5 continenti con headquarter in Italia
- 4 stabilimenti produttivi
- 64.000 m² coperti
- Oltre 700 tra dipendenti e collaboratori
- 4.100 ton./mese spedite
- 40 milioni di semilavorati venduti mediamente in un anno
- Oltre 2000 clienti grossisti in 136 Stati nel mondo;
- Oltre 32.000 articoli diversi a stock



HIGHLIGHTS

| | | |
|--|--|--|
| <p>PAG.199 11.A</p>  <p>Art. 80/A/3</p> | <p>PAG.117 5.A</p>  <p>Art. GD301/2</p> | <p>PAG.178 8.A</p>  <p>Art. 725/1</p> |
| <p>PAG. 214 11.A</p>  <p>Art.94/F/3</p> | <p>PAG.133 5.D</p>  <p>Art.GD300/2</p> | <p>PAG.34 1.F</p>  <p>Art. 114/4</p> |
| <p>PAG.144 5.G</p>  <p>Art.GD282/2</p> | <p>PAG.70 3</p>  <p>Art. GD271/3</p> | <p>PAG.159 6</p>  <p>Art.1276/1</p> |
| <p>PAG.122 5.B</p>  <p>Art.GD289/2</p> | <p>PAG.162 7.A</p>  <p>Art.1757/43</p> | <p>PAG.247 17.A</p>  <p>Art.F0222</p> |
| <p>PAG.45 2.B</p>  <p>Art.1361/3</p> | <p>PAG.53 2.D</p>  <p>Art.1852/67</p> | <p>PAG.126 5.B</p>  <p>Art.GD295/1</p> |

HIGHLIGHTS

| | | |
|--|--|--|
| <p>PAG.46 2.B</p>  <p>Art. GD124/7</p> | <p>PAG.90 4.B</p>  <p>Art. 1718/9</p> | <p>PAG.177 8.A</p>  <p>Art. 126/A/2</p> |
| <p>PAG.189 9</p>  <p>Art. GD268/2</p> | <p>PAG.104 4.F</p>  <p>Art. 801/3</p> | <p>PAG.182 8.B</p>  <p>Art. 1400/1</p> |
| <p>PAG.116 5.A</p>  <p>Art. GD287/1</p> | <p>PAG.25 1.E</p>  <p>Art. 1374/2/S1</p> | <p>PAG.205 11.A</p>  <p>Art. 1308/8</p> |
| <p>PAG.98 4.D</p>  <p>Art. 1688/3</p> | <p>PAG.246 17.A</p>  <p>Art. F085700</p> | <p>PAG.89 4.B</p>  <p>Art. 1730/4</p> |
| <p>PAG.174 8.A</p>  <p>Art. 1854/9</p> | <p>PAG.120 5.B</p>  <p>Art. GD302/2</p> | <p>PAG.235 15</p>  <p>Art. 136/1</p> |

1 Long bars
Barre lunghe pag. 15

| | | |
|-------------------------------------|----------------------------|--------|
| 1.A Plain bars | Barre lisce | pag.17 |
| 1.B Decorative round bars | Tondi lavorati | pag.19 |
| 1.C Decorative square bars | Quadri lavorati | pag.20 |
| 1.D Decorative flat bars | Piatti lavorati | pag.22 |
| 1.E Hammered edges tubes | Tubi lavorati | pag.24 |
| 1.F Handrails and End pieces | Corrimani e Partenze | pag.26 |
| 1.G Twisted bars | Torciglioni | pag.36 |
| 1.H Collars | Fascette | pag.38 |

2 Pierced bars - Shaped bars
Barre forate - Barre sagomate pag. 43

| | | |
|-------------------------------------|------------------------------------|--------|
| 2.A Round pierced bars | Barre forate in tondo | pag.44 |
| 2.B Square pierced bars | Barre forate in quadro | pag.45 |
| 2.C Flat punched bars | Piatti forati | pag.48 |
| 2.D Punched tubes | Tubi forati | pag.53 |
| 2.E Pierced posts | Montanti forati | pag.54 |
| 2.F Bars with stamped rivets | Barre con ribattini stampati | pag.56 |
| 2.G Shaped bars | Barre sagomate | pag.58 |

3 Overthrows
Cimase pag. 61

4 Classical Pickets and Panels
Paletti e Pannelli classici pag. 71

| | | |
|--------------------------------------|--------------------------------------|---------|
| 4.A Forged pickets | Paletti forgiati | pag.72 |
| 4.B Stamped pickets | Paletti conati | pag.80 |
| 4.C Tube pickets | Paletti in tubo | pag.92 |
| 4.D Pickets with twisting | Paletti con torciglione | pag.94 |
| 4.E Pickets with big twisting | Paletti con torciglione grande | pag.100 |
| 4.F Pickets with baskets | Paletti con pigna | pag.102 |
| 4.G "S" shaped panels | Pannelli ad "esse" | pag.105 |
| 4.H Panels with scrolls | Pannelli con ricci | pag.110 |

5 Modern pickets and Panels
Paletti e Pannelli moderni pag. 113

| | | |
|------------------------------|-------|---------|
| 5.A Geometric Style | | pag.114 |
| 5.B Linear Style | | pag.120 |
| 5.C Floreal Style | | pag.129 |
| 5.D Waves Style | | pag.132 |
| 5.E Impero Style | | pag.135 |
| 5.F Revolution Style | | pag.137 |
| 5.G New Classic Style | | pag.141 |
| 5.H New Liberty Style | | pag.148 |

6 Bowed pickets
Pancioni pag. 151

7 Pickets for fencing
Paletti per recinzione pag. 161

| | | |
|----------------------------------|------------------------------|---------|
| 7.A Stamped pickets | Paletti conati | pag.162 |
| 7.B Electrowelded pickets | Paletti elettrosaldati | pag.171 |

8 Spear points and Post tops
Lance, Pomoli e Terminali a colonna pag. 173

| | | |
|-------------------------|---------------------------|---------|
| 8.A Spear points | Lance terminali | pag.174 |
| 8.B Tops | Pomoli | pag.181 |
| 8.C Post tops | Terminali a colonna | pag.183 |

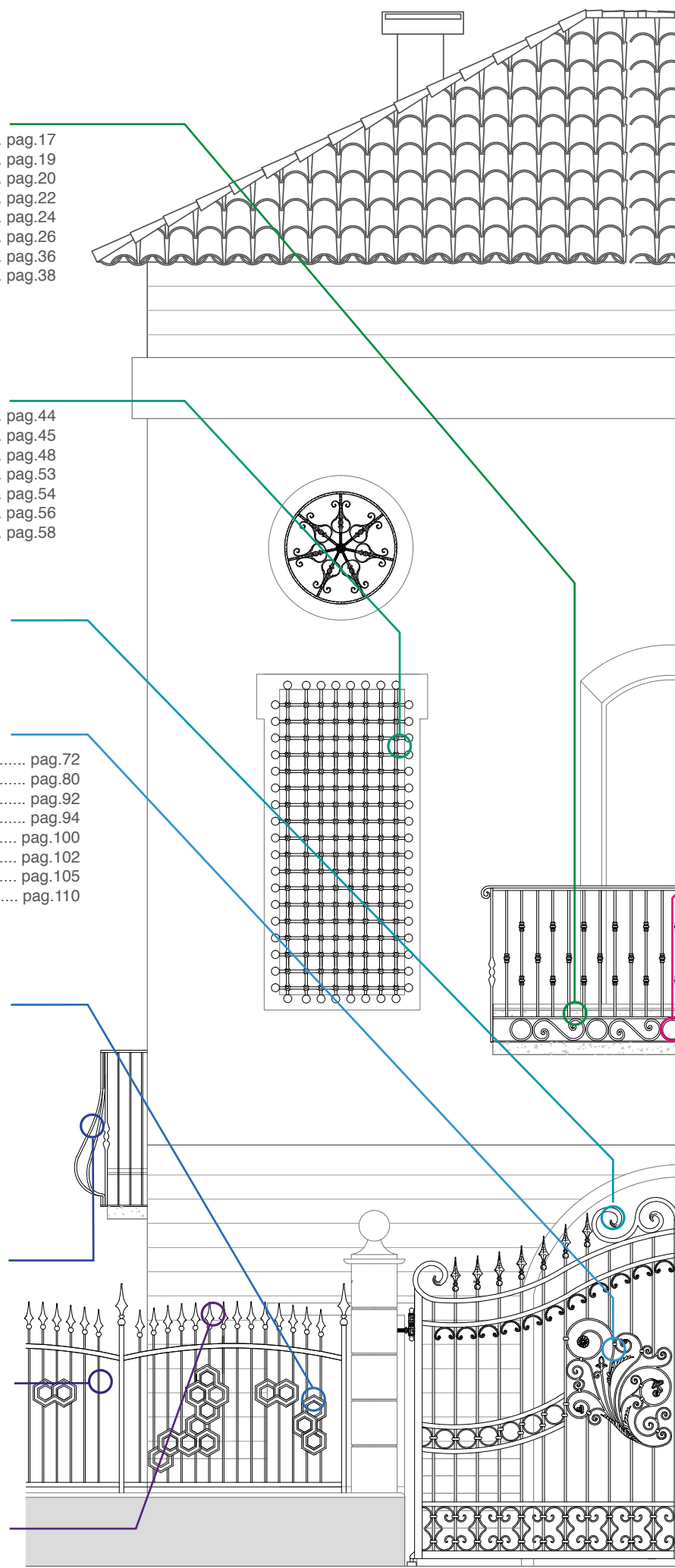

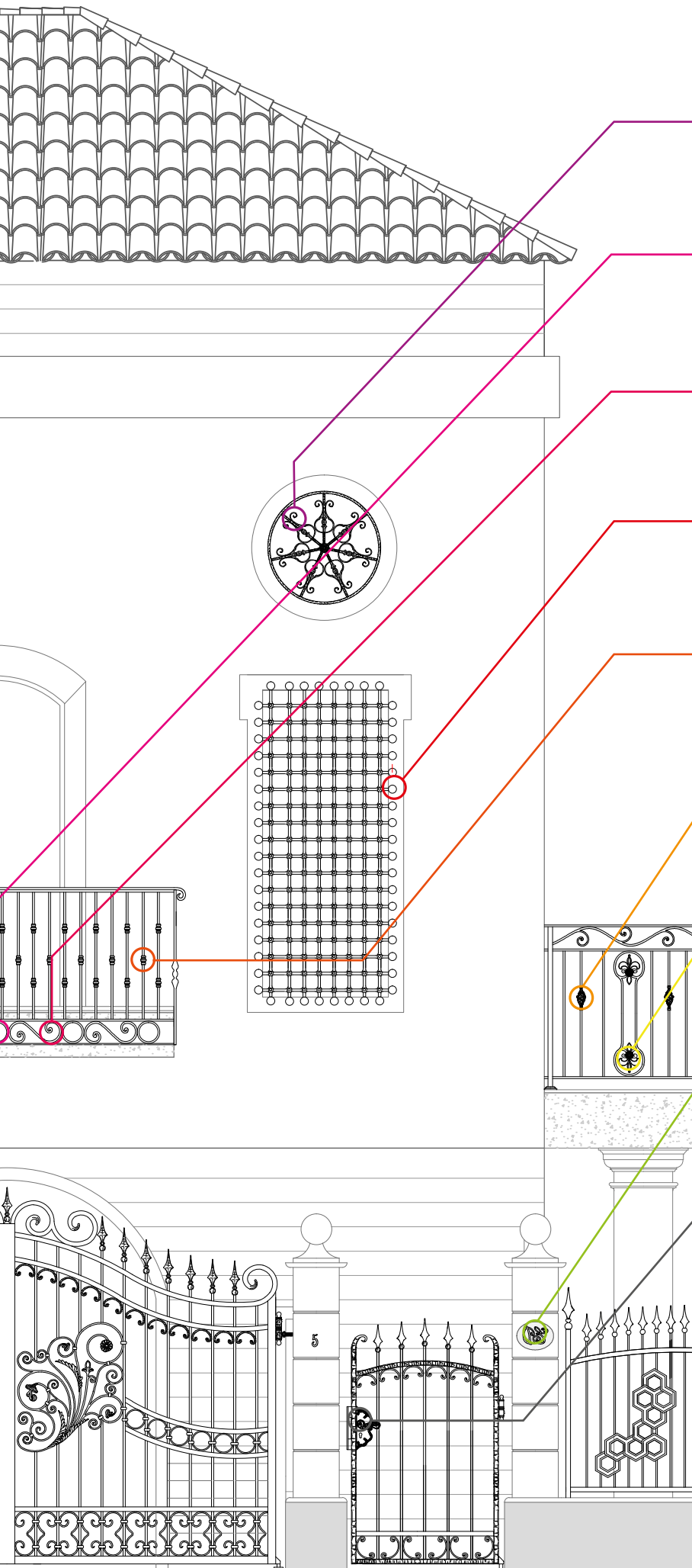



9 Rosaces
Rosoni pag. 185 

10 Rings
Cerchi pag. 193 

11 Scrolls and Snap-ons
Ricci e Snap-ons pag. 197 

11.A Scrolls - Ricci pag.198
11.B Snap-ons pag.215

12 Spheres
Sfere pag. 217 

13 Bushes
Borchie pag. 219 

14 Baskets
Pigne pag. 229 

15 Flowers and Rosettes
Fiori e Rosette pag. 233 

16 Decorations in steel sheet
Decori in lamiera pag. 237 

17 Plates and Accessories
Piastre ed Accessori pag. 243 

- 17.A** Anchor plates - Piastre di ancoraggio pag.244
- 17.B** Rivets - Ribattini pag.248
- 17.C** Chains - Catene..... pag.249
- 17.D** Door handles - Manigliepag.250
- 17.E** Locks covers - Copriserratura..... pag.253
- 17.F** Locks - Serrature pag.254
- 17.G** Hinges - Cardini..... pag.255
- 17.H** Paints and varnishes - Patine e Vernici .. pag.257
- 17.I** Weathervanes and Mail boxes pag.258
Segnavento e Cassette postali

18 Tools
Utensili pag. 259 

Siamo qui. We are here.



1

ITALIA - Headquarters

Ind.i.a. spa
Via Vicenza, 6/14
36034 - Malo
Vicenza • Italia
tel. +39 0445 580 580 • fax: +39 0445 580 874
info@india.it • www.india.it



2

U.S.A.

Indital US Ltd
7947 Mesa Drive
77028 - Houston
Texas • U.S.A.
tel. +1 713 694 6065 • fax: +1 713 694 2055
forgings@indital.com • www.indital.com



3

FLORIDA - CARAIBI

Arteferro Miami LLC
2955 NW 75th Street
33147 - Miami
Florida • U.S.A.
tel. +1 305 836 9232 • fax: +1 305 836 4113
info@arteferromiami.com • www.arteferromiami.com



4

ITALIA

Co.Ge.Me. Steel srl
Via Enrico Fermi 34
26041 - Casalmaggiore
Cremona • Italia
tel. +39 0375 284820 • fax +39 0375 203877
info@cogemesteel.com



5

DEUTSCHLAND

Triebenbacher Betriebsgesellschaft mbH
Gutenbergstraße 1
85737 Ismaning
Deutschland
tel. +49 (0) 89/57 09 2850 • fax: +49 (0) 89/57 09 2838
info@triebenbacher.de • www.triebenbacher.de



6

FRANCE

Ind.i.a. France Sarl
P.A.E. la Baume, 7 Rue de l'Artisanat
34290 - Servian
Servian • France
tel. +33 (0) 4 67 39 42 81 • fax: +33 (0) 4 67 39 20 90
info@indiafrance.eu • www.indiafrance.eu



7

HRVATSKA

Arteferro Dohomont doo
Gospodarska 1/A
40324 - Gorican
Gorican • Hrvatska
tel. +385 (0) 40 602 222 • fax: +385 (0) 40 602 230
info@arteferro-dohomont.hr • www.arteferro-dohomont.hr



8

ESPAÑA

Ind.i.a. España, SL
C/ Abedul, 43 - Polig. Ind. El Guijar
28500 - Arganda del Rey
Madrid • España
tel. +34 918 700 819 • fax: +34 918 700 820
info@arteferro.es • www.arteferro.es

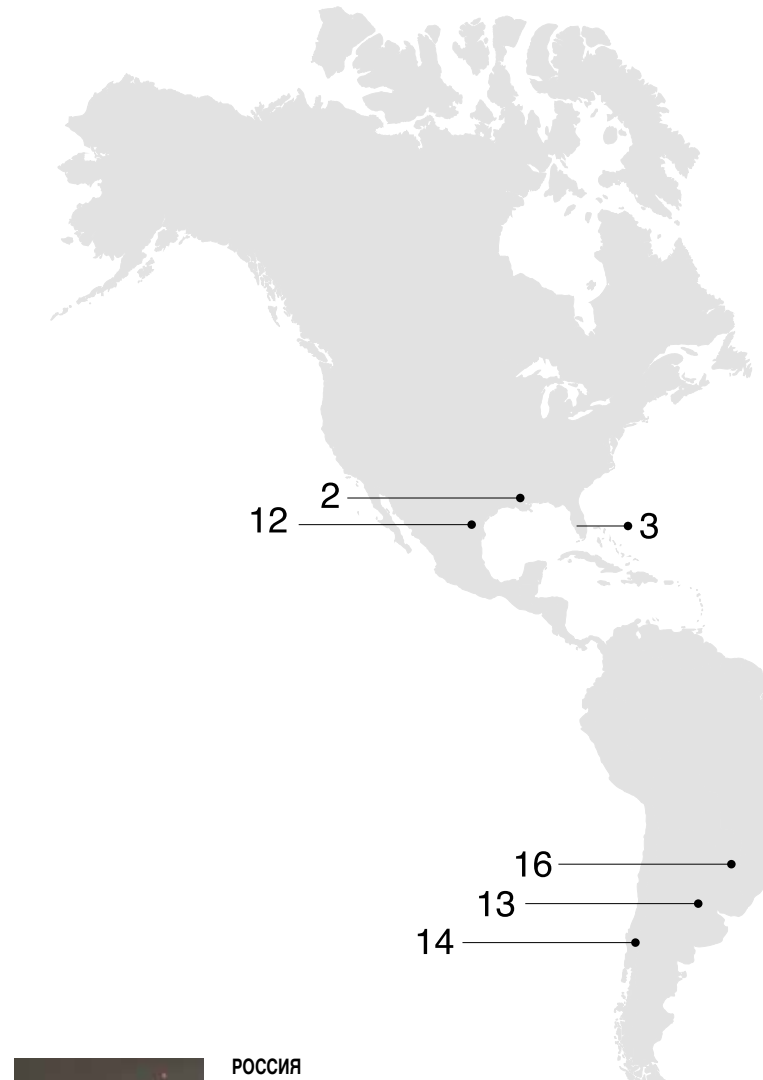

12 — 2 — 3

16 — 13 — 14



9

РОССИЯ

ООО "АРТЕФЕРРО-РУССИЯ"
603124, Россия, Нижний Новгород, Вторчермета 1Г
Тел. +7-831-2621999
info@arteferrorussia.com
www.arteferro.ru



10

УКРАЇНИ

Arteferro Ukraina
Avtoparkova, 5
02660 - Киев
Україна
tel. +380 44 492 03 31 • fax: +380 44 492 03 32
office@arteferroukraine.com • www.arteferroukraine.com



11

SVERIGE - DANMARK

Arteferro Skandinavien AB
Röda Stugans gata 2
602 28 - Norrköping
Sverige
tel. +46 (0) 11 18 23 23 • fax: +46 (0) 11182328
info@arteferro.se • www.arteferro.se



12

MÉXICO

Arteferro Monterrey SA de CV
Privada la Puerta 2879 B-4
66350 - Col. Parque Industrial - La Puerta Santa Catarina
Nuevo Leon • México
tel. +52 1 81 1295 5094/95 • fax: +52 1 81 1295 5097
info@arteferromexico.com • www.arteferromexico.com



13



ARGENTINA

Arteferro Argentina SA
 Suárez 760
 1162 - Buenos Aires
 Argentina
 tel. +54 11 4301 2637 • fax: +54 11 4301 2637
 info@arteferroargentina.com • www.arteferroargentina.com

16



BRASIL

Ind.i.a. Brasil LTDA
 Rua Padre Feijó, 480
 95190-000 - São Marcos
 Rio Grande do Sul • Brasil
 tel. +55 54 3291 1416 • fax: +55 54 3291 1416
 Branch
 Av. Almirante Cochrane, 194 – Sala 32
 11040-200 – Santos - Sao Paulo • Brasil
 tel. +55 13 21389091
 vendas@arteferrobrasil.com.br
 www.arteferrobrasil.com.br

14



CHILE

Arteferro Chile SA
 Calle Los Arrayanes, 250, bodega 4
 9340000 -Santiago
 Colina • Chile
 tel. +56 2 738 7419 • fax: +56 2 738 7419
 arteferro@arteferrochile.cl • www.arteferrochile.cl

15



中华人民共和国

China (Shandong province)
 Representative Far East
 india@arteferro.com

Our brands I nostri marchi

Gonzato Group manufactures and distributes exclusively the products of its brands

Gonzato Group produce e distribuisce in esclusiva le realizzazioni dei suoi marchi



The Arteferro product line includes over 32,000 semi-finished ornamental items made of wrought iron, brass, and bronze: pierced bars, forged pickets, pre-assembled panels, leaves, flowers, baskets, roses, scrolls, rings, and other decorative elements, as well as a rich variety of home furnishings. It is the task of blacksmiths to assemble them into finished objects such as railings, fences, or any other creation suggests his creativity.

La gamma di prodotti Arteferro comprende oltre 32.000 elementi semilavorati ornamentali in ferro battuto, ottone e bronzo: barre forate, paletti forgiati, pannelli preassemblati, foglie, fiori, pigne, rosoni, ricci, cerchi ed altri elementi decorativi, oltre ad una ricca serie di complementi d'arredo. Sarà compito del fabbro assemblarli in oggetti finiti come parapetti, recinzioni o qualsiasi altra creazione gli suggerisca la sua creatività.



The IAM Design product line includes more than 2,500 modular stainless steel elements to achieve railings, fences, canopies, staircases, and other structural elements, both for interior and external spaces. The modern and linear design of the various elements allows a quick and easy installation, and meets the needs of architects, designers and professionals, adapting perfectly to any type of environment.

La gamma di prodotti IAM Design comprende oltre 2.500 elementi componibili e modulari in acciaio inox per realizzare parapetti, recinzioni, pensiline, scale ed altri elementi strutturali, per interni ed esterni. Il design moderno e lineare dei vari elementi consente una facile e veloce installazione e soddisfa le esigenze di architetti, progettisti e professionisti adattandosi perfettamente ad ogni tipo di ambiente.



CO.GE.ME.Steel was founded in 1970 with a mission: to enter in quality steel manufacturing as main players, producing steel that craftsmen and industries could find perfect for their production needs.

CO.GE.ME. Steel srl nasce nel 1970 con una missione: entrare nella siderurgia di qualità da protagonisti, producendo acciaio che artigiani e industriali trovassero perfetto per le proprie esigenze produttive.

Our turnkey services I nostri servizi "chiavi in mano"



Gonzato Contract is the division of Ind.i.a. that works with special supplies, in wrought iron, stainless steel, or any other metal; for prestigious private homes, public buildings, community spaces and for each kind of commission that requires a custom-made approach all, from the planning to installation. Assisting the customer during all the process, from the first steps to the finished work, Gonzato Contract is the ideal partner for any project, placing itself towards the client like the sole responsible of the quality of its product and its service.

Gonzato Contract è la divisione di Ind.i.a. che si occupa di fornire speciali, in ferro battuto, in acciaio inox o in qualsiasi altro metallo, per prestigiose proprietà private, edifici pubblici, alberghi, spazi comunitari e per ogni tipo di commissione che richieda un approccio custom made, dalla progettazione all'installazione. Affiancando il committente durante tutto il percorso, dai primi passi fino al lavoro finito, Gonzato Contract è partner ideale per ogni progetto e si pone nei confronti del cliente come unica responsabile della qualità del proprio prodotto e del servizio offerto.



Production

From idea to installation, we take care of every aspect of the product.

Our items, compared to most of the products that are on the market, are manufactured in our production sites in Italy and Europe and are subject to quality tests that allow us to know the life of each piece, from its birth to its delivery.

In addition, we are the only company in the industry that can boast a production capacity can meet any special request within tight production times.

Produzione

Dall'ideazione all'installazione, ci occupiamo di ogni aspetto del prodotto.

I nostri articoli, rispetto alla gran parte dei prodotti che si trovano sul mercato, sono realizzati nei nostri centri produttivi in Italia ed Europa, sottostando a test qualitativi che ci consentono di conoscere la vita di ogni pezzo, dalla sua nascita alla sua consegna.

Inoltre, siamo l'unica azienda del settore che può vantare una capacità produttiva in grado di soddisfare ogni richiesta speciale entro tempi di stretta produzione.





Ordered, delivered!

With our branches, spread across all continents, we have the largest stock of articles in the sector in the world and, thanks to our agreements with major global couriers, we guarantee fast deliveries to any country. Furthermore, thanks to our portal Ind.i.a. Web, customers can stay up to date on the stock and on the details of their orders.

Ordinato, consegnato!

Con le nostre filiali sparse in tutti i continenti, disponiamo del più grande stock mondiale di articoli del settore e, grazie ai nostri accordi con i più importanti spedizionieri, possiamo garantire consegne celeri in qualsiasi paese. Inoltre, grazie al nostro portale Ind.i.a. web, i clienti possono rimanere aggiornati sulle scorte di magazzino e sui dettagli dei propri ordini.

Best price

The large quantities we treat, allow us scale economies on the raw material. In addition, the price of our pricelists is the price of manufacturer, not subject to recharges due to the presence of intermediaries. It is a factory price!

Miglior prezzo

Le grosse quantità che trattiamo ci consentono economie di scala sulla materia prima. Inoltre, il prezzo dei nostri listini, è il prezzo del produttore, non soggetto a ricariche dovute alla presenza di intermediari. È un prezzo di fabbrica!

Custom design

Our technicians are available for specialized advice and are able to develop customized projects. With our division Gonzato Contract we can also provide turnkey solutions, from design to installation.

Progettazione su misura

I nostri tecnici sono a disposizione per consulenze specializzate e sono in grado di sviluppare progetti su misura. Con la nostra divisione Gonzato Contract possiamo fornire anche soluzioni chiavi in mano, dalla progettazione all'installazione.

Products for installation, finishing and maintenance

In addition to our products, we also provide products and tools for their installation, finishing and maintenance: tools for assembly and treatment, paints and coatings to finish and embellish, cleaning products to maintain the beauty of the installation unchanged in time.

Prodotti per l'installazione, finitura e manutenzione

Oltre ai nostri articoli, forniamo anche i prodotti e gli strumenti per la loro installazione, finitura e manutenzione: attrezzi per il montaggio e il trattamento, vernici e patine per rifinire ed impreziosire, prodotti per la pulizia per mantenere la bellezza dell'installazione invariata nel tempo.



Innovation

The customer and his needs are the focus of our attention. For this reason, a team of designers and engineers works daily to conceive new products that meet the growing need for beauty in harmony with the technical requirements existing at present.

We are constantly looking at different materials to be combine to our lines to enhance the structural and aesthetic (wood, glass and many others).

We study the design of our products so that they can be ahead of the times. We believe that products should be easy to assemble and integrate with other architectural elements in order to adapt to the environment in which they are installed with maximum flexibility.

Innovazione

Il cliente e le sue esigenze sono il fulcro della nostra attenzione. Per questo motivo un team di designers ed ingegneri lavora quotidianamente all'ideazione di nuovi prodotti che soddisfino sempre più la necessità di bellezza in armonia con le esigenze tecniche oggi esistenti.

Siamo costantemente alla ricerca di materiali diversi da accompagnare alle nostre linee per esaltarne le caratteristiche strutturali ed estetiche (legno, vetro e molti altri ancora).

Studiamo il design dei nostri prodotti in modo che possano essere al passo con i tempi. Crediamo che i prodotti debbano essere semplici da assemblare e da integrare con gli altri elementi architettonici in modo da potersi adattare all'ambiente in cui vengono installati con la massima flessibilità.



More value
to your purchase
Maggior valore
al tuo acquisto



Guaranteed, certified and patented quality

Our articles are produced in our production centers in Italy and in Europe. We can manage the entire production chain ensuring the best final quality. This quality has long been recognized by the certifications obtained ISO 9001 and ISO 14011. A further added value, always as guarantee of originality and quality, it is represented by the patents obtained for many of our items, with the aim to protect both the inventiveness of our designer and the trust of our customers.

Qualità garantita, certificata e brevettata

I nostri articoli vengono realizzati nei nostri centri produttivi in Italia e in Europa. Possiamo quindi gestire tutta la catena di produzione garantendo così la migliore qualità finale. Tale qualità è da anni riconosciuta anche dalle certificazioni ottenute ISO 9001 e ISO 14011. Un ulteriore valore aggiunto, sempre a garanzia di originalità e qualità, è rappresentato dai brevetti registrati per molti dei nostri articoli, con lo scopo di tutelare sia l'ingegno dei nostri designer sia la fiducia dei nostri clienti.



An excellence customer service

Our back-office staff is fluent in five languages and is on hand to give you all the information and support you need.

Un servizio clienti d'eccellenza

Il nostro staff di back office parla fluentemente cinque lingue diverse ed è a vostra disposizione per darvi tutte le informazioni ed il supporto che vi servono.



A marketing department at your disposal

Our marketing department is on hand to organize activities and to develop promotional materials personalized with the customer's logo. For years now we make flyers and catalogs tailored to our loyal customers.

Un ufficio marketing a tua disposizione

Il nostro ufficio marketing è a disposizione per organizzare attività ed elaborare materiale promozionale personalizzato con il logo del cliente. Da anni ormai realizziamo volantini e cataloghi ad hoc per i nostri clienti più affezionati.



Educational

With our specialized staff, we organize meetings of technical training: all you need to know to design and install parapets, railings, stairs and other structural elements in accordance with law.

Formazione

Con il nostro personale specializzato, organizziamo incontri di formazione tecnica: tutto ciò che bisogna sapere per progettare ed installare parapetti, cancellate, scale ed altri elementi strutturali a norma di legge.



LONG BARS

BARRE LUNGHE

Arteferro long bars are variously shaped metal bars, used for a multitude of applications: along a staircase or wall where a support is needed, or as a structural part of a gate or fence. Using both hot and cold processes, they are available in lengths of 3 and 6 metres, with square, rectangular or round sections. To complete the section, there's a wide range of fittings, joints and clamps for tightening of decorative elements.

Le barre lunghe Arteferro sono barre di metallo variamente sagomate, si usano in una moltitudine di applicazioni: lungo una scala od una parete in cui sia necessario un appoggio, come parte strutturale di un cancello o di una recinzione. Con lavorazioni sia a caldo che a freddo sono disponibili nelle lunghezze da 3 e 6 metri, con sezioni quadre, rettangolari o tonde. A completare il capitolo, la vasta gamma di partenze, giunzioni e fascette per il serraggio di elementi decorativi.

Long Bars - Barre lunghe

| | | |
|----------------------------|---------------------------|--------|
| A Plain bars | Barre lisce | pag.17 |
| B Decorative round bars | Tondi lavorati | pag.19 |
| C Decorative square bars | Quadri lavorati | pag.20 |
| D Decorative flat bars | Piatti lavorati..... | pag.22 |
| E Hammered edges tubes | Tubi lavorati..... | pag.24 |
| F Handrails and end pieces | Corrimani e Partenze..... | pag.26 |
| G Twisted pickets | Torciglioni | pag.36 |
| H Collars | Fascette | pag.38 |

**Choose the section!
Identifying the finish is
very easy**

**Parti dalla sezione!
individuare la finitura
sarà un gioco da ragazzi**



Not all of the Arterferro items are available in **Arterferro Quick**, just a special selection. Find out about the entire range in the catalogue

In **Arterferro Quick** non sono presenti tutti gli articoli Arterferro, ma solo una speciale selezione. Scopri la gamma completa nel catalogo

Compendium





Choose the item, add "/Z" to order the galvanized version

Scegli l'articolo, aggiungi "/Z" per ordinare la versione zincata a freddo



7000 t

of bars and handrails manufactured each month in our forges

di barre e corrimani vengono forgiate ogni mese nelle nostre fucine

Example - Esempio

1368/23/6000/Z = galvanized version
= versione zincata a freddo

HOT ROLLED ROUND AND SQUARE PLAIN BARS
TONDI E QUADRI LISCI LAMINATI A CALDO



| Section Sezione | Length Lunghezza | Mech. hammering Lav. meccanica |
|--------------------|---------------------|-----------------------------------|
| | | Plain Liscio |
| | | Art. |
| Ø 6 mm | 3000 mm | 1368/6 |
| | 6000 mm | 1368/6/6000 |
| Ø 7 mm | 3000 mm | - |
| | 6000 mm | - |
| Ø 8 mm | 3000 mm | 1368/7 |
| | 6000 mm | 1368/7/6000 |
| Ø 10 mm | 3000 mm | 1368/8 |
| | 6000 mm | 1368/8/6000 |
| Ø 12 mm | 3000 mm | 1368/9 |
| | 6000 mm | 1368/9/6000 |
| Ø 14 mm | 3000 mm | 1368/10 |
| | 6000 mm | 1368/10/6000 |
| Ø 16 mm | 3000 mm | 1368/23 |
| | 6000 mm | 1368/23/6000 |
| Ø 18 mm | 3000 mm | 1368/24 |
| | 6000 mm | 1368/24/6000 |
| Ø 20 mm | 3000 mm | 1368/25 |
| | 6000 mm | 1368/25/6000 |
| Ø 22 mm | 3000 mm | 1368/32 |
| | 6000 mm | 1368/32/6000 |
| Ø 24 mm | 3000 mm | 1368/33 |
| | 6000 mm | 1368/33/6000 |
| Ø 25 mm | 3000 mm | 1368/25/S |
| | 6000 mm | 1368/25/S/6000 |
| Ø 26 mm | 3000 mm | 1368/34 |
| | 6000 mm | 1368/34/6000 |
| Ø 30 mm | 3000 mm | 1368/35 |
| | 6000 mm | 1368/35/6000 |
| Ø 35 mm | 3000 mm | - |
| | 6000 mm | - |
| Ø 40 mm | 3000 mm | - |
| | 6000 mm | - |
| Ø 50 mm | 3000 mm | - |
| | 6000 mm | - |

| Section Sezione | Mech. hammering Lav. meccanica |
|--------------------|-----------------------------------|
| | Plain Liscio |
| | Art. |
| 6 x 6 mm | 1368/1 |
| | 1368/1/6000 |
| 7 x 7 mm | 1368/27 |
| | 1368/27/6000 |
| 8 x 8 mm | 1368/2 |
| | 1368/2/6000 |
| 10 x 10 mm | 1368/3 |
| | 1368/3/6000 |
| 12 x 12 mm | 1368/4 |
| | 1368/4/6000 |
| 14 x 14 mm | 1368/5 |
| | 1368/5/6000 |
| 16 x 16 mm | 1368/20 |
| | 1368/20/6000 |
| 18 x 18 mm | 1368/21 |
| | 1368/21/6000 |
| 20 x 20 mm | 1368/22 |
| | 1368/22/6000 |
| 22 x 22 mm | 1368/28 |
| | 1368/28/6000 |
| 24 x 24 mm | - |
| | - |
| 25 x 25 mm | 1368/26 |
| | 1368/26/6000 |
| 26 x 26 mm | - |
| | - |
| 30 x 30 mm | 1368/22/S |
| | 1368/22/S/6000 |
| 35 x 35 mm | 1368/29 |
| | 1368/29/6000 |
| 40 x 40 mm | 1368/30 |
| | 1368/30/6000 |
| 50 x 50 mm | 1368/31 |
| | 1368/31/6000 |



Plain bars - Barre lisce

HOT ROLLED FLAT BARS - PIATTI LAMINATI A CALDO

NEW



| Section Sezione | Length Lunghezza Art. | Mech. hammering Lav. meccanica |
|--------------------|-----------------------------|-----------------------------------|
| | | Plain Liscio Art. |
| 10 x 5 mm | 3000 mm | 1368/11 |
| | 6000 mm | 1368/11/6000 |
| 12 x 4 mm | 3000 mm | 1368/37 |
| | 6000 mm | 1368/37/6000 |
| 12 x 5 mm | 3000 mm | 1368/38 |
| | 6000 mm | 1368/38/6000 |
| 12 x 6 mm | 3000 mm | 1368/12 |
| | 6000 mm | 1368/12/6000 |
| 12 x 8 mm | 3000 mm | 1368/39 |
| | 6000 mm | 1368/39/6000 |
| 14 x 4 mm | 3000 mm | 1368/40 |
| | 6000 mm | 1368/40/6000 |
| 14 x 6 mm | 3000 mm | 1368/41 |
| | 6000 mm | 1368/41/6000 |
| 14 x 8 mm | 3000 mm | 1368/13 |
| | 6000 mm | 1368/13/6000 |
| 16 x 4 mm | 3000 mm | 1368/14 |
| | 6000 mm | 1368/14/6000 |
| 16 x 5 mm | 3000 mm | 1368/42 |
| | 6000 mm | 1368/42/6000 |
| 16 x 6 mm | 3000 mm | 1368/43 |
| | 6000 mm | 1368/43/6000 |
| 16 x 8 mm | 3000 mm | 1368/44 |
| | 6000 mm | 1368/44/6000 |
| 16 x 10 mm | 3000 mm | 1368/45 |
| | 6000 mm | 1368/45/6000 |
| 20 x 3 mm | 3000 mm | 1368/46 |
| | 6000 mm | 1368/46/6000 |
| 20 x 4 mm | 3000 mm | 1368/15 |
| | 6000 mm | 1368/15/6000 |
| 20 x 5 mm | 3000 mm | 1368/47 |
| | 6000 mm | 1368/47/6000 |
| 20 x 6 mm | 3000 mm | 1368/16 |
| | 6000 mm | 1368/16/6000 |
| 20 x 8 mm | 3000 mm | 1368/48 |
| | 6000 mm | 1368/48/6000 |
| 20 x 10 mm | 3000 mm | 1368/49 |
| | 6000 mm | 1368/49/6000 |
| 20 x 15 mm | 3000 mm | 1368/50 |
| | 6000 mm | 1368/50/6000 |
| 25 x 3 mm | 3000 mm | 1368/51 |
| | 6000 mm | 1368/51/6000 |
| 25 x 4 mm | 3000 mm | 1368/17 |
| | 6000 mm | 1368/17/6000 |
| 25 x 5 mm | 3000 mm | 1368/52 |
| | 6000 mm | 1368/52/6000 |
| 25 x 6 mm | 3000 mm | 1368/53 |
| | 6000 mm | 1368/53/6000 |
| 25 x 8 mm | 3000 mm | 1368/54 |
| | 6000 mm | 1368/54/6000 |
| 25 x 10 mm | 3000 mm | 1368/55 |
| | 6000 mm | 1368/55/6000 |
| 30 x 5 mm | 3000 mm | 1368/57 |
| | 6000 mm | 1368/57/6000 |
| 30 x 6 mm | 3000 mm | 1368/58 |
| | 6000 mm | 1368/58/6000 |
| 30 x 8 mm | 3000 mm | 1368/18 |
| | 6000 mm | 1368/18/6000 |
| 30 x 10 mm | 3000 mm | 1368/59 |
| | 6000 mm | 1368/59/6000 |
| 30 x 12 mm | 3000 mm | 1368/60 |
| | 6000 mm | 1368/60/6000 |

NEW



| Section Sezione | Length Lunghezza Art. | Mech. hammering Lav. meccanica |
|--------------------|-----------------------------|-----------------------------------|
| | | Plain Liscio Art. |
| 30 x 15 mm | 3000 mm | 1368/61 |
| | 6000 mm | 1368/61/6000 |
| 30 x 20 mm | 3000 mm | 1368/62 |
| | 6000 mm | 1368/62/6000 |
| 35 x 4 mm | 3000 mm | 1368/63 |
| | 6000 mm | 1368/63/6000 |
| 35 x 5 mm | 3000 mm | 1368/64 |
| | 6000 mm | 1368/64/6000 |
| 35 x 6 mm | 3000 mm | 1368/65 |
| | 6000 mm | 1368/65/6000 |
| 35 x 8 mm | 3000 mm | 1368/66 |
| | 6000 mm | 1368/66/6000 |
| 35 x 10 mm | 3000 mm | 1368/67 |
| | 6000 mm | 1368/67/6000 |
| 35 x 12 mm | 3000 mm | 1368/68 |
| | 6000 mm | 1368/68/6000 |
| 35 x 15 mm | 3000 mm | 1368/69 |
| | 6000 mm | 1368/69/6000 |
| 40 x 4 mm | 3000 mm | 1368/70 |
| | 6000 mm | 1368/70/6000 |
| 40 x 5 mm | 3000 mm | 1368/71 |
| | 6000 mm | 1368/71/6000 |
| 40 x 6 mm | 3000 mm | 1368/72 |
| | 6000 mm | 1368/72/6000 |
| 40 x 8 mm | 3000 mm | 1368/19 |
| | 6000 mm | 1368/19/6000 |
| 40 x 10 mm | 3000 mm | 1368/73 |
| | 6000 mm | 1368/73/6000 |
| 40 x 12 mm | 3000 mm | 1368/74 |
| | 6000 mm | 1368/74/6000 |
| 40 x 15 mm | 3000 mm | 1368/75 |
| | 6000 mm | 1368/75/6000 |
| 40 x 20 mm | 3000 mm | 1368/76 |
| | 6000 mm | 1368/76/6000 |
| 45 x 6 mm | 3000 mm | 1368/77 |
| | 6000 mm | 1368/77/6000 |
| 45 x 8 mm | 3000 mm | 1368/78 |
| | 6000 mm | 1368/78/6000 |
| 45 x 10 mm | 3000 mm | 1368/79 |
| | 6000 mm | 1368/79/6000 |
| 45 x 12 mm | 3000 mm | 1368/80 |
| | 6000 mm | 1368/80/6000 |
| 45 x 20 mm | 3000 mm | 1368/81 |
| | 6000 mm | 1368/81/6000 |
| 50 x 3 mm | 3000 mm | 1368/82 |
| | 6000 mm | 1368/82/6000 |
| 50 x 4 mm | 3000 mm | 1368/83 |
| | 6000 mm | 1368/83/6000 |
| 50 x 6 mm | 3000 mm | 1368/84 |
| | 6000 mm | 1368/84/6000 |
| 50 x 8 mm | 3000 mm | 1368/85 |
| | 6000 mm | 1368/85/6000 |
| 50 x 10 mm | 3000 mm | 1368/86 |
| | 6000 mm | 1368/86/6000 |
| 50 x 12 mm | 3000 mm | 1368/87 |
| | 6000 mm | 1368/87/6000 |
| 50 x 20 mm | 3000 mm | 1368/88 |
| | 6000 mm | 1368/88/6000 |
| 50 x 25 mm | 3000 mm | 1368/89 |
| | 6000 mm | 1368/89/6000 |
| 60 x 4 mm | 3000 mm | 1368/90 |
| | 6000 mm | 1368/90/6000 |

NEW



| Section Sezione | Length Lunghezza Art. | Mech. hammering Lav. meccanica |
|--------------------|-----------------------------|-----------------------------------|
| | | Plain Liscio Art. |
| 60 x 6 mm | 3000 mm | 1368/91 |
| | 6000 mm | 1368/91/6000 |
| 60 x 8 mm | 3000 mm | 1368/92 |
| | 6000 mm | 1368/92/6000 |
| 60 x 10 mm | 3000 mm | 1368/93 |
| | 6000 mm | 1368/93/6000 |
| 60 x 12 mm | 3000 mm | 1368/94 |
| | 6000 mm | 1368/94/6000 |
| 60 x 20 mm | 3000 mm | 1368/95 |
| | 6000 mm | 1368/95/6000 |
| 70 x 5 mm | 3000 mm | 1368/96 |
| | 6000 mm | 1368/96/6000 |
| 70 x 6 mm | 3000 mm | 1368/97 |
| | 6000 mm | 1368/97/6000 |
| 70 x 8 mm | 3000 mm | 1368/98 |
| | 6000 mm | 1368/98/6000 |
| 80 x 8 mm | 3000 mm | 1368/99 |
| | 6000 mm | 1368/99/6000 |
| 90 x 4 mm | 3000 mm | 1368/100 |
| | 6000 mm | 1368/100/6000 |
| 90 x 5 mm | 3000 mm | 1368/101 |
| | 6000 mm | 1368/101/6000 |
| 100 x 8 mm | 3000 mm | 1368/102 |
| | 6000 mm | 1368/102/6000 |
| 120 x 8 mm | 3000 mm | 1368/103 |
| | 6000 mm | 1368/103/6000 |



COLD PROCESSED - LAVORATI A FREDDO

Decorative round bars - Tondi lavorati



| Section Sezione | Length Lunghezza | Mech. hammering Lav. meccanica Grapevine effect Tralcio vite Art. | Mech. hammering Lav. meccanica Bark effect Corteccia Art. | Power hammering Lav. manuale Power long hammering Magliatura piatta allungata Art. | Power hammering Lav. manuale Power hammered Magliato Art. | Power hammering Lav. manuale Hammered Battuto Art. |
|--------------------|---------------------|---|---|--|---|--|
| 6 mm | 3000 mm | - | - | - | - | 600/1 |
| | 6000 mm | - | - | - | - | - |
| 8 mm | 3000 mm | 598/11 | 599/1 | - | 598/10 | 600/2 |
| | 6000 mm | 598/11/6000 | - | - | - | - |
| 10 mm | 3000 mm | 598/12 | 599/2 | - | - | 600/3 |
| | 6000 mm | - | 599/2/6000 | - | - | 600/3/6000 |
| 12 mm | 3000 mm | 598/13 | 599/3 | 598/1 | - | 600/4 |
| | 6000 mm | 598/13/6000 | 599/3/6000 | - | - | 600/4/6000 |
| 14 mm | 3000 mm | 598/14 | 599/4 | 598/2 | 118/A/10 | 600/5 |
| | 6000 mm | - | 599/4/6000 | - | - | 600/5/6000 |
| 16 mm | 3000 mm | 598/15 | 599/5 | 598/3 | 118/A/11 | 600/6 |
| | 6000 mm | - | 599/5/6000 | - | - | 600/6/6000 |
| 18 mm | 3000 mm | 598/16 | 599/6 | 598/4 | 118/A/12 | 600/7 |
| | 6000 mm | - | 599/6/6000 | - | - | 600/7/6000 |
| 20 mm | 3000 mm | - | 599/7 | 598/5 | 118/A/13 | 600/8 |
| | 6000 mm | - | 599/7/6000 | - | - | 600/8/6000 |
| 22 mm | 3000 mm | 598/18 | 599/8 | - | - | 600/9 |
| | 6000 mm | - | 599/8/6000 | - | - | 600/9/6000 |
| 24 mm | 3000 mm | - | 599/9 | - | - | 600/10 |
| | 6000 mm | - | 599/9/6000 | - | - | 600/10/6000 |
| 25 mm | 3000 mm | - | - | 598/6 | 118/A/14 | - |
| | 6000 mm | - | - | - | - | - |
| 26 mm | 3000 mm | - | - | - | - | - |
| | 6000 mm | - | - | - | - | - |
| 30 mm | 3000 mm | - | - | 598/7 | 118/A/15 | - |
| | 6000 mm | - | - | - | - | - |
| 40 mm | 3000 mm | - | - | 598/8 | 118/A/16 | - |
| | 6000 mm | - | - | - | - | - |





| Section Sezione | Length Lunghezza | Mech. hammering Lav. meccanica Hammered 4 edges Battuto 4 spigoli | Mech. hammering Lav. meccanica Hammered 4 sides and 4 edges Battuto 4 lati e 4 spigoli | Mech. hammering Lav. meccanica Hammered 4 sides Battuto 4 lati | Mech. hammering Lav. meccanica Hammered 4 sides Battuto 4 lati | Mech. hammering Lav. meccanica Flat beveled 4 edges Smuss. piana 4 spigoli | Mech. hammering Lav. meccanica Hammered 4 sides Magliatura 4 lati | Mech. hammering Lav. meccanica Diamond 2 sides Diamantato 2 lati |
|--------------------|---------------------|--|---|---|---|---|--|---|
| | | Art. | Art. | Art. | Art. | Art. | Art. | Art. |
| 6 x 6 mm | 3000 mm | - | - | - | - | - | - | - |
| | 6000 mm | - | - | - | - | - | - | - |
| 7 x 7 mm | 3000 mm | - | - | - | - | - | - | - |
| | 6000 mm | - | - | - | - | - | - | - |
| 8 x 8 mm | 3000 mm | - | - | - | - | - | - | - |
| | 6000 mm | - | - | - | - | - | - | - |
| 10 x 10 mm | 3000 mm | - | - | - | - | - | - | - |
| | 6000 mm | 118/1/Q10/6000 | - | - | - | - | - | - |
| 12 x 12 mm | 3000 mm | 118/1 | 118/A/1 | 1841/1 | 1841/30 | GD124/17 | 1370/15 | 1370/13 |
| | 6000 mm | 118/1/6000 | 118/A/1/6000 | - | - | GD124/25 | 1370/15/6000 | 1370/13/6000 |
| 14 x 14 mm | 3000 mm | 118/2 | 118/A/2 | 1841/2 | 1841/31 | GD124/18 | 1370/16 | 1370/14 |
| | 6000 mm | 118/2/6000 | 118/A/2/6000 | - | - | GD124/26 | 1370/16/6000 | 1370/14/6000 |
| 15 x 15 mm | 3000 mm | - | - | - | - | - | - | - |
| | 6000 mm | - | - | - | - | - | - | - |
| 16 x 16 mm | 3000 mm | 118/3 | 118/A/3 | 1841/3 | 1841/32 | GD124/19 | 1370/17 | - |
| | 6000 mm | 118/3/6000 | 118/A/3/6000 | - | - | GD124/27 | 1370/17/6000 | - |
| 17 x 17 mm | 3000 mm | - | - | - | - | - | - | - |
| | 6000 mm | - | - | - | - | - | - | - |
| 18 x 18 mm | 3000 mm | 118/4 | 118/A/4 | 1841/4 | 1841/33 | GD124/20 | 1370/18 | - |
| | 6000 mm | 118/4/6000 | 118/A/4/6000 | - | - | GD124/28 | 1370/18/6000 | - |
| 20 x 20 mm | 3000 mm | 118/5 | 118/A/5 | 1841/5 | 1841/34 | GD124/21 | 1370/19 | - |
| | 6000 mm | 118/5/6000 | 118/A/5/6000 | - | - | GD124/29 | 1370/19/6000 | - |
| 21 x 21 mm | 3000 mm | - | - | - | - | - | - | - |
| | 6000 mm | - | - | - | - | - | - | - |
| 22 x 22 mm | 3000 mm | - | - | 1841/6 | 1841/35 | GD124/22 | 1370/20 | - |
| | 6000 mm | - | - | - | - | GD124/30 | 1370/20/6000 | - |
| 23 x 23 mm | 3000 mm | - | - | - | - | - | - | - |
| | 6000 mm | - | - | - | - | - | - | - |
| 24 x 24 mm | 3000 mm | - | - | - | - | - | - | - |
| | 6000 mm | - | - | - | - | - | - | - |
| 25 x 25 mm | 3000 mm | 118/6 | 180/53 | 1841/7 | 1841/36 | GD124/23 | 1370/21 | - |
| | 6000 mm | 118/6/6000 | 180/53/6000 | - | - | GD124/31 | 1370/21/6000 | - |
| 26 x 26 mm | 3000 mm | - | - | - | - | - | - | - |
| | 6000 mm | - | - | - | - | - | - | - |
| 27 x 27 mm | 3000 mm | - | - | - | - | - | - | - |
| | 6000 mm | - | - | - | - | - | - | - |
| 30 x 30 mm | 3000 mm | 118/24 | 180/50 | - | - | GD124/24 | 1370/22 | - |
| | 6000 mm | 118/24/6000 | 180/50/6000 | - | - | GD124/32 | 1370/22/6000 | - |
| 35 x 35 mm | 3000 mm | 118/24/S | - | - | - | - | 1370/23 | - |
| | 6000 mm | 118/24/6000/S | - | - | - | - | 1370/23/6000 | - |
| 40 x 40 mm | 3000 mm | 118/25 | 180/54 | - | - | - | 1370/24 | - |
| | 6000 mm | 118/25/6000 | 180/54/6000 | - | - | - | 1370/24/6000 | - |
| 50 x 50 mm | 3000 mm | - | - | - | - | - | 1370/25 | - |
| | 6000 mm | - | - | - | - | - | 1370/25/6000 | - |



COLD PROCESSED - LAVORATI A FREDDO

Decorative square bars - Quadri lavorati



| Section Sezione | Length Lunghezza | Mech. hammering Lav. meccanica Hammered 4 sides Martellato 4 lati Art. | Mech. hammering Lav. meccanica Bark effect 4 sides Corteccia 4 lati Art. | Mech. hammering Lav. meccanica Four-leaf clover Quadrifoglio Art. | Mech. hammering Lav. meccanica Grooved 4 sides Rigato 4 lati Art. | Mech. hammering Lav. meccanica Grooved and hamm. 4 sides Rigato e spigolato 4 lati Art. | Mech. hammering Lav. meccanica Multiriga 4 lati Art. | Mech. hammering Lav. meccanica Irregular beveled 4 corners Smuss. irregolare 4 angoli Art. |
|--------------------|---------------------|--|--|---|---|---|---|--|
| 6 x 6 mm | 3000 mm | 118/15/Q/6 | - | - | - | - | - | - |
| | 6000 mm | - | - | - | - | - | - | - |
| 7 x 7 mm | 3000 mm | 118/15/S | - | - | - | - | - | - |
| | 6000 mm | - | - | - | - | - | - | - |
| 8 x 8 mm | 3000 mm | 118/15 | - | - | 625/1 | - | - | - |
| | 6000 mm | 118/15/6000 | - | - | - | - | - | - |
| 10 x 10 mm | 3000 mm | 118/16 | 623/4 | 626/10 | 625/2 | - | - | - |
| | 6000 mm | 118/16/6000 | 623/4/6000 | 626/10/6000 | - | - | - | - |
| 12 x 12 mm | 3000 mm | 118/17 | 623/5 | - | 625/3 | 625/8 | - | - |
| | 6000 mm | 118/17/6000 | 623/5/6000 | - | - | - | - | - |
| 14 x 14 mm | 3000 mm | 118/18 | 623/6 | 626/12 | 625/4 | - | - | - |
| | 6000 mm | 118/18/6000 | 623/6/6000 | 626/12/6000 | - | - | - | - |
| 15 x 15 mm | 3000 mm | - | - | 626/13 | - | - | - | - |
| | 6000 mm | - | - | 626/13/6000 | - | - | - | - |
| 16 x 16 mm | 3000 mm | 118/19 | 623/7 | - | 625/5 | 625/9 | - | - |
| | 6000 mm | 118/19/6000 | 623/7/6000 | - | - | - | - | - |
| 17 x 17 mm | 3000 mm | - | - | 626/14 | - | - | - | - |
| | 6000 mm | - | - | 626/14/6000 | - | - | - | - |
| 18 x 18 mm | 3000 mm | 118/20 | 623/8 | 626/15 | 625/6 | - | - | - |
| | 6000 mm | 118/20/6000 | 623/8/6000 | 626/15/6000 | - | - | - | - |
| 20 x 20 mm | 3000 mm | 118/21 | 623/9 | - | 625/7 | - | - | - |
| | 6000 mm | 118/21/6000 | 623/9/6000 | - | - | - | - | - |
| 21 x 21 mm | 3000 mm | - | - | - | - | - | - | - |
| | 6000 mm | - | - | - | - | - | - | - |
| 22 x 22 mm | 3000 mm | - | - | - | - | - | - | - |
| | 6000 mm | - | - | - | - | - | - | - |
| 23 x 23 mm | 3000 mm | - | - | 626/16 | - | - | - | - |
| | 6000 mm | - | - | 626/16/6000 | - | - | - | - |
| 24 x 24 mm | 3000 mm | - | 623/11 | - | - | - | - | - |
| | 6000 mm | - | 623/11/6000 | - | - | - | - | - |
| 25 x 25 mm | 3000 mm | 118/22 | - | - | - | - | - | GD124/36 |
| | 6000 mm | 118/22/6000 | - | - | - | - | - | GD124/33 |
| 26 x 26 mm | 3000 mm | - | - | - | - | - | - | - |
| | 6000 mm | - | - | - | - | - | - | - |
| 27 x 27 mm | 3000 mm | - | - | - | - | - | - | - |
| | 6000 mm | - | - | - | - | - | - | - |
| 30 x 30 mm | 3000 mm | 118/23 | - | - | 1806/3 | - | 1806/9 | - |
| | 6000 mm | 118/23/6000 | - | - | 1806/6 | - | 1806/12 | - |
| 35 x 35 mm | 3000 mm | - | - | - | - | - | - | - |
| | 6000 mm | - | - | - | - | - | - | - |
| 40 x 40 mm | 3000 mm | 118/23/S | - | - | 1806/2 | - | 1806/8 | GD124/37 |
| | 6000 mm | - | - | - | 1806/5 | - | 1806/11 | GD124/34 |
| 50 x 50 mm | 3000 mm | - | - | - | 1806/1 | - | 1806/7 | GD124/38 |
| | 6000 mm | - | - | - | 1806/4 | - | 1806/10 | GD124/35 |



Items
GD124/33, 34
and 35 were used
to create
the new features
of the Colosseum in Rome.

Gli articoli GD124/33, 34
e 35 sono stati utilizzati
per la realizzazione
delle nuove cancellate
del Colosseo a Roma.



Arteferro
products
can be manufactured
as well as customised.

I prodotti Arteferro
sono realizzabili
anche su misura.



| Section Sezione | Length Lunghezza | Mech. hammering Lav. meccanica | Mech. hammering Lav. meccanica | Mech. hammering Lav. meccanica | Mech. hammering Lav. meccanica | Mech. hammering Lav. meccanica |
|--------------------|---------------------|---|---|--|--|--|
| | | Hammered 2 edges Spigolato 2 spigoli | Hammered 4 edges Spigolato 4 spigoli | Diamond 2 small sides Diamantato 2 lati piccoli | Grooved 2 small sides Rigato 2 lati piccoli | Notched 2 small sides Tachettato 2 lati piccoli |
| | | Art. | Art. | Art. | Art. | Art. |
| ∅ 12 x 6 mm | 3000 mm | - | 1839/21 | 623/1 | 1369/1/S | 622/1 |
| | 6000 mm | - | 1839/21/6000 | 623/1/6000 | 1369/1/S/6000 | 622/1/6000 |
| ∅ 14 x 6 mm | 3000 mm | - | 1839/22 | 623/3 | 1369/1/S1 | 622/6 |
| | 6000 mm | - | 1839/22/6000 | 623/3/6000 | 1369/1/S1/6000 | 622/6/6000 |
| ∅ 14 x 8 mm | 3000 mm | - | 1839/23 | 623/12 | 1369/1 | 622/3 |
| | 6000 mm | - | 1839/23/6000 | 623/12/6000 | 1369/1/6000 | 622/3/6000 |
| ∅ 16 x 6 mm | 3000 mm | - | 1839/26 | 623/2 | 1369/1/S2 | 622/4 |
| | 6000 mm | - | 1839/26/6000 | 623/2/6000 | 1369/1/S2/6000 | 622/4/6000 |
| ∅ 16 x 8 mm | 3000 mm | - | 1839/24 | 623/13 | 1369/2 | 622/5 |
| | 6000 mm | - | 1839/24/6000 | 623/13/6000 | 1369/2/6000 | 622/5/6000 |
| ∅ 20 x 6 mm | 3000 mm | - | - | 623/2/S | - | 622/4/S |
| | 6000 mm | 118/7/20X6/6000 | 1839/15/S/L6 | - | - | 622/4/S/6000 |
| ∅ 20 x 8 mm | 3000 mm | 118/7 | 118/7/S1 | - | - | 622/5/S1 |
| | 6000 mm | 118/7/6000 | 118/7/S1/6000 | - | - | - |
| ∅ 20 x 10 mm | 3000 mm | - | 118/7/S | - | - | - |
| | 6000 mm | - | 118/7/S/6000 | - | - | - |
| ∅ 25 x 5 mm | 3000 mm | - | - | - | - | - |
| | 6000 mm | 1838/5/S/6000 | - | - | - | - |
| ∅ 25 x 6 mm | 3000 mm | 1838/5 | 1839/15 | - | - | - |
| | 6000 mm | 1838/5/6000 | 1839/15/6000 | - | - | - |
| ∅ 25 x 8 mm | 3000 mm | 118/8 | 1839/16 | - | - | 622/5/S2 |
| | 6000 mm | 118/8/6000 | 1839/16/6000 | - | - | - |
| ∅ 25 x 10 mm | 3000 mm | 1838/6 | 118/8/S1 | - | - | - |
| | 6000 mm | 1838/6/6000 | 118/8/S1/6000 | - | - | - |
| ∅ 30 x 6 mm | 3000 mm | 1838/7 | 1839/17 | - | - | - |
| | 6000 mm | 1838/7/6000 | 1839/17/6000 | - | - | - |
| ∅ 30 x 8 mm | 3000 mm | 114/9 | 1839/18 | - | - | 622/5/S |
| | 6000 mm | 114/9/6000 | 1839/18/6000 | - | - | - |
| ∅ 30 x 10 mm | 3000 mm | 114/9/S2 | 118/9/S1 | - | - | - |
| | 6000 mm | 118/9/S/6000 | 118/9/S1/6000 | - | - | - |
| ∅ 30 x 12 mm | 3000 mm | - | 1839/18/S | - | - | - |
| | 6000 mm | - | 1839/18/S6000 | - | - | - |
| ∅ 30 x 15 mm | 3000 mm | - | 1839/1 | - | - | - |
| | 6000 mm | - | 1839/1/6000 | - | - | - |
| ∅ 30 x 20 mm | 3000 mm | - | 1839/2 | - | - | - |
| | 6000 mm | - | 1839/2/6000 | - | - | - |
| ∅ 35 x 8 mm | 3000 mm | 114/9/35X8 | 1839/18/S1 | - | - | - |
| | 6000 mm | 114/9/35X8/6000 | 1839/18/S2 | - | - | - |
| ∅ 35 x 10 mm | 3000 mm | - | 1839/18/S3 | - | - | - |
| | 6000 mm | - | 1839/18/S4 | - | - | - |
| ∅ 35 x 15 mm | 3000 mm | - | 1839/1/S | - | - | - |
| | 6000 mm | - | 1839/1/S/6000 | - | - | - |
| ∅ 40 x 6 mm | 3000 mm | 1838/2/S/3000 | 1839/19 | - | - | - |
| | 6000 mm | 1838/2/S/6000 | 1839/19/6000 | - | - | - |
| ∅ 40 x 8 mm | 3000 mm | 1838/2 | 1839/20 | - | - | - |
| | 6000 mm | 1838/2/6000 | 1839/20/6000 | - | - | - |
| ∅ 40 x 10 mm | 3000 mm | 1838/2/S1 | 1839/20/S3 | - | - | - |
| | 6000 mm | 1838/2/S1/6000 | 1839/20/S3/6000 | - | - | - |
| ∅ 40 x 15 mm | 3000 mm | - | 1839/3 | - | - | - |
| | 6000 mm | - | 1839/3/6000 | - | - | - |
| ∅ 40 x 20 mm | 3000 mm | - | 1839/4 | - | - | - |
| | 6000 mm | - | 1839/4/6000 | - | - | - |
| ∅ 50 x 6 mm | 3000 mm | 1838/3/S7 | 1839/19/50X6 | - | - | - |
| | 6000 mm | 1838/3/S6 | 1839/19/S1 | - | - | - |
| ∅ 50 x 8 mm | 3000 mm | 1838/3 | 1838/3/S1 | - | - | - |
| | 6000 mm | 1838/3/6000 | 1838/3/S2 | - | - | - |
| ∅ 50 x 10 mm | 3000 mm | 1838/3/S5 | 1839/20/S4 | - | - | - |
| | 6000 mm | 1838/3/S4 | 1839/20/S6000 | - | - | - |
| ∅ 60 x 6 mm | 3000 mm | 1838/4/S1 | 1839/19/60X6 | - | - | - |
| | 6000 mm | 1838/4/S1/L6 | 1839/19/S | - | - | - |
| ∅ 60 x 8 mm | 3000 mm | 1838/4 | 1839/20/S1 | - | - | - |
| | 6000 mm | 1838/4/6000 | 1839/20/S2 | - | - | - |

COLD PROCESSED - LAVORATI A FREDDO

Decorative flat bars - Piatti lavorati



| Section Sezione | Length Lunghezza | Mech. hammering Lav. meccanica | Mech. hammering Lav. meccanica | Mech. hammering Lav. meccanica | Mech. hammering Lav. meccanica | Mech. hammering Lav. meccanica |
|--------------------|---------------------|---|---|------------------------------------|---|---|
| | | Hammered 2 wide sides Martellato 2 lati larghi | Hamm. 2 sides and 4 edges Battuto 2 lati e 4 spigoli | Hammered 2 sides Battuto 2 lati | Hammered 2 sides and 4 edges Martellato 2 lati e 4 spigoli | Hammered 1 side and 2 edges Battuto 1 lato e 2 spigoli |
| ∅ 12 x 6 mm | 3000 mm | - | - | - | - | - |
| | 6000 mm | - | - | - | - | - |
| ∅ 14 x 6 mm | 3000 mm | 118/10/S1 | - | - | - | - |
| | 6000 mm | - | - | - | - | - |
| ∅ 14 x 8 mm | 3000 mm | - | - | - | - | - |
| | 6000 mm | - | - | - | - | - |
| ∅ 16 x 4 mm | 3000 mm | 118/10 | - | - | - | - |
| | 6000 mm | - | - | - | - | - |
| ∅ 16 x 6 mm | 3000 mm | - | - | - | - | - |
| | 6000 mm | - | - | - | - | - |
| ∅ 16 x 8 mm | 3000 mm | - | - | - | - | - |
| | 6000 mm | - | - | - | - | - |
| ∅ 20 x 4 mm | 3000 mm | 118/11 | - | - | - | - |
| | 6000 mm | 118/11/6000 | - | - | - | - |
| ∅ 20 x 6 mm | 3000 mm | 118/12 | - | - | - | - |
| | 6000 mm | 118/12/6000 | - | - | - | - |
| ∅ 20 x 8 mm | 3000 mm | 118/26 | 118/A/6/20X8 | - | - | - |
| | 6000 mm | - | 118/A/6/20X8/6000 | - | - | - |
| ∅ 25 x 4 mm | 3000 mm | 118/27 | - | - | - | - |
| | 6000 mm | - | - | - | - | - |
| ∅ 25 x 5 mm | 3000 mm | 118/27/S | - | - | - | - |
| | 6000 mm | 118/27/S/6000 | - | - | - | - |
| ∅ 25 x 8 mm | 3000 mm | 118/28 | - | - | - | - |
| | 6000 mm | - | - | - | - | - |
| ∅ 25 x 5 mm | 3000 mm | 118/13/S | - | - | - | - |
| | 6000 mm | 118/13/S/6000 | - | - | - | - |
| ∅ 30 x 6 mm | 3000 mm | - | 118/A/6/SS | 1839/7 | 1839/11 | - |
| | 6000 mm | - | 118/A/6/S/L6 | 1839/7/6000 | 1839/11/6000 | - |
| ∅ 30 x 8 mm | 3000 mm | 118/13 | 118/A/6 | 1839/8 | 1839/12 | - |
| | 6000 mm | 118/13/6000 | 118/A/6/6000 | 1839/8/6000 | 1839/12/6000 | - |
| ∅ 30 x 10 mm | 3000 mm | - | 118/A/7 | - | - | - |
| | 6000 mm | - | 118/A/7/6000 | - | - | - |
| ∅ 30 x 15 mm | 3000 mm | 118/13/S1 | 118/A/8 | - | - | - |
| | 6000 mm | - | 118/A/8/6000 | - | - | - |
| ∅ 30 x 20 mm | 3000 mm | 180/51 | 118/A/9 | - | - | - |
| | 6000 mm | - | 118/A/9/6000 | - | - | - |
| ∅ 40 x 4 mm | 3000 mm | 118/29 | - | - | - | - |
| | 6000 mm | 118/29/6000 | - | - | - | - |
| ∅ 40 x 6 mm | 3000 mm | - | - | 1839/9 | 1839/13 | 1839/5 |
| | 6000 mm | - | - | 1839/9/6000 | 1839/13/6000 | 1839/5/6000 |
| ∅ 40 x 8 mm | 3000 mm | 118/14 | 118/A/6/S | - | 1839/14 | 1839/6 |
| | 6000 mm | 118/14/6000 | 118/A/6/S/6000 | - | 1839/14/6000 | 1839/6/6000 |
| ∅ 40 x 10 mm | 3000 mm | 118/14/S2 | - | 1839/10 | - | - |
| | 6000 mm | 118/14/S2/6000 | - | 1839/10/6000 | - | - |
| ∅ 40 x 15 mm | 3000 mm | 118/14/S3 | - | - | - | - |
| | 6000 mm | - | - | - | - | - |
| ∅ 40 x 20 mm | 3000 mm | - | 118/A/9/S | - | - | - |
| | 6000 mm | - | 118/A/9/S/6000 | - | - | - |
| ∅ 50 x 4 mm | 3000 mm | 118/30 | - | - | - | - |
| | 6000 mm | - | - | - | - | - |
| ∅ 50 x 8 mm | 3000 mm | - | 118/A/6/50X8 | - | - | - |
| | 6000 mm | - | 118/A/6/50X8/6000 | - | - | - |
| ∅ 60 x 8 mm | 3000 mm | - | - | - | 1839/14/S | - |
| | 6000 mm | - | - | - | - | - |

i Choose the item, add "/Z" to order the galvanized version

i Scegli l'articolo, aggiungi "/Z" per ordinare la versione zincata a freddo

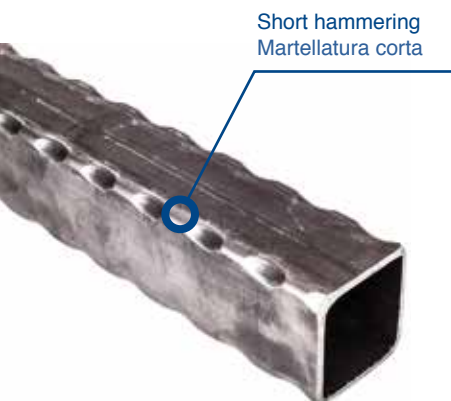
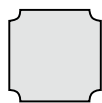
SQUARE TUBES WITH SHORT HAMMERING ON EDGES
TUBI QUADRATI CON MARTELLATURA CORTA SUGLI SPIGOLI

| Section Sezione | Thickness Spessore | L 3000 mm | L 6000 mm |
|--------------------|-----------------------|-----------|-----------|
| | | Art. | Art. |
| Φ 12 x 12 mm | 1 mm | 1374/21 | 1374/19 |
| Φ 12 x 12 mm | 1,5 mm | 1374/26 | 1374/27 |
| Φ 16 x 16 mm | 1 mm | 1374/22 | 1374/20 |
| Φ 16 x 16 mm | 1,5 mm | 1374/25 | 1374/24 |
| Φ 20 x 20 mm | 2,5 mm | 1374/1 | 118/E/1 |
| Φ 25 x 25 mm | 2,5 mm | 1374/2 | 118/E/9 |
| Φ 30 x 30 mm | 2,5 mm | 1374/3 | 118/E/3 |
| Φ 35 x 35 mm | 2,5 mm | 1374/23 | 118/E/18 |
| Φ 40 x 40 mm | 2,5 mm | 1374/4 | 118/E/5 |
| Φ 50 x 50 mm | 2,5 mm | 1374/5 | 1374/15 |
| Φ 60 x 60 mm | 2,5 mm | - | 118/E/13 |
| Φ 80 x 80 mm | 2,7 mm | 1374/6 | 1374/16 |
| Φ 100 x 100 mm | 2,7 mm | 1374/7 | 1374/17 |
| Φ 120 x 120 mm | 2,7 mm | 1374/8 | 1374/18 |



Choose the item,
add "/Z" to order the
galvanized version

Scegli l'articolo,
aggiungi "/Z" per ordinare
la versione zincata a
freddo

RECTANGULAR TUBES WITH SHORT HAMMERING ON EDGES
TUBI RETTANGOLARI CON MARTELLATURA CORTA SUGLI SPIGOLI

| Section Sezione | Thickness Spessore | L 3000 mm | L 6000 mm |
|--------------------|-----------------------|------------|------------|
| | | Art. | Art. |
| ∅ 30 x 20 mm | 2,5 mm | 1374/9 | 118/E/2 |
| ∅ 40 x 20 mm | 2,5 mm | 1374/10 | 118/E/4 |
| ∅ 40 x 30 mm | 2,5 mm | 1374/10/S4 | 118/E/19 |
| ∅ 50 x 30 mm | 2,5 mm | 1374/11 | 118/E/6 |
| ∅ 50 x 40 mm | 2,5 mm | 1374/11/S5 | 118/E/14 |
| ∅ 60 x 30 mm | 2,5 mm | 1374/12 | 118/E/7 |
| ∅ 60 x 40 mm | 2,5 mm | 1374/29 | 118/E/15 |
| ∅ 80 x 40 mm | 2,7 mm | 1374/13 | 118/E/8 |
| ∅ 80 x 60 mm | 2,7 mm | 1374/13/S | 118/E/8/S1 |
| ∅ 100 x 40 mm | 2,7 mm | 1374/14 | 118/E/10 |
| ∅ 100 x 50 mm | 2,7 mm | 1374/30 | 118/E/17 |
| ∅ 120 x 40 mm | 2,7 mm | - | 118/E/12 |

SQUARE TUBES WITH LONG HAMMERING ON EDGES TUBI QUADRATI CON MARTELLATURA ALLUNGATA SUGLI SPIGOLI

NEW

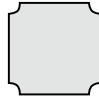

Long hammering
Martellatura allungata



| Section Sezione | Thickness Spessore | L 3000 mm | L 6000 mm |
|--------------------|-----------------------|------------|------------|
| | | Art. | Art. |
| □ 25 x 25 mm | 2,5 mm | 1374/2/S1 | 118/E/9/S1 |
| □ 25 x 25 mm | 2 mm | 1374/2/S2 | 118/E/9/S2 |
| □ 30 x 30 mm | 2,5 mm | 1374/3/S2 | 118/E/3/S4 |
| □ 30 x 30 mm | 2 mm | 1374/3/S4 | 118/E/3/S5 |
| □ 40 x 40 mm | 2,5 mm | 1374/4/S1 | 118/E/5/S3 |
| □ 50 x 50 mm | 2,5 mm | 1374/5/S | 1374/15/S2 |
| □ 60 x 60 mm | 2,5 mm | 1374/12/S4 | 118/E/7/S5 |

BEST PRICE

RECTANGULAR TUBES WITH LONG HAMMERING ON EDGES TUBI RETTANGOLARI CON MARTELLATURA ALLUNGATA SUGLI SPIGOLI

NEW



Long hammering
Martellatura allungata



| Section Sezione | Thickness Spessore | L 3000 mm | L 6000 mm |
|--------------------|-----------------------|------------|------------|
| | | Art. | Art. |
| ▧ 30 x 20 mm | 2,5 mm | 1374/9/S1 | 118/E/2/S1 |
| ▧ 30 x 20 mm | 2 mm | 1374/9/S | 118/E/2/S2 |
| ▧ 40 x 20 mm | 2,5 mm | 1374/10/S2 | 118/E/4/S2 |
| ▧ 40 x 20 mm | 2 mm | 1374/10/S6 | 118/E/4/S4 |
| ▧ 40 x 30 mm | 2,5 mm | 1374/10/S3 | 118/E/4/S3 |
| ▧ 50 x 30 mm | 2,5 mm | 1374/11/S1 | 118/E/6/S1 |
| ▧ 50 x 30 mm | 2 mm | 1374/11/S4 | 118/E/6/S4 |
| ▧ 50 x 40 mm | 2,5 mm | 1374/11/S2 | 118/E/6/S5 |
| ▧ 50 x 40 mm | 2 mm | 1374/11/S3 | 118/E/6/S3 |
| ▧ 60 x 30 mm | 2,5 mm | 1374/12/S2 | 118/E/7/S3 |
| ▧ 60 x 40 mm | 2,5 mm | 1374/12/S1 | 118/E/16 |

END PIECES FOR HOT ROLLED HANDRAILS - PARTENZE PER CORRIMANI LAMINATI A CALDO

Hot hammered - Coniato a caldo



Arteferro bars are produced by paying attention to detail and cut at the ends

Le barre Arteferro sono curate in ogni dettaglio ed anche rifilate alle estremità.

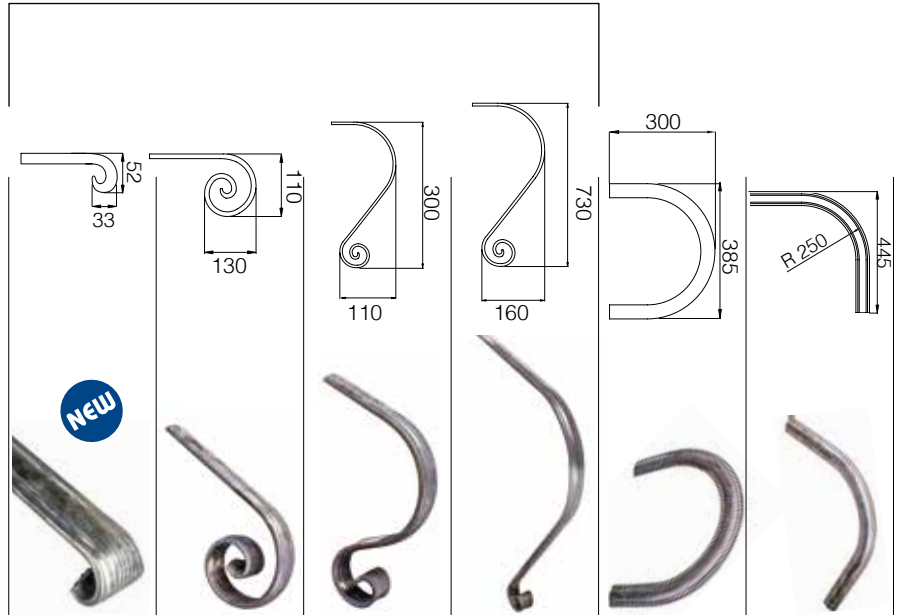

| Image | L 3000 mm | L 6000 mm | Section | Section | | | | | | |
|---------|-----------|---------------|--------------|-------------|------------|------------|-----------|--------|---------|--|
| | Art. | Art. | Sezione | Art. | Art. | Art. | Art. | Art. | Art. | |
| | 1373/4 | 1373/4/6000 | 40 x 11 mm | 1817/9/S5 | 1817/9 | 1817/5 | 1817/1 | 1822/2 | 1822/13 | |
| | 1373/3 | 1373/3/6000 | 45 x 12 mm | - | 1377/24 | 1377/11 | 1817/2 | 1822/3 | 1822/14 | |
| | 114/A/3 | 114/A/3/6000 | 50 x 14 mm | 114/B/13/S9 | 114/B/13 | 114/B/14 | 114/B/15 | 1822/1 | 1822/12 | |
| | 1373/2 | 1373/2/6000 | 60 x 16 mm | - | 1377/23 | 1817/8 | 1817/3 | 1822/4 | 1822/15 | |
| | 158/9/C | 158/9/C/6000 | 25 x 7 mm | - | - | - | - | - | - | |
| | 158/10/C | 158/10/C/6000 | 30 x 8 mm | - | 1819/29 | 1819/30 | 1819/13/S | - | - | |
| | 810/A/1 | 810/A/10 | 30 x 10 mm | - | 812/5/S1 | 812/1/S4 | - | - | - | |
| | 810/A/2 | 810/A/11 | 35 x 10 mm | - | 812/5 | 812/1 | 1819/13 | - | - | |
| | 810/A/23 | 810/A/24 | 35 x 15 mm | - | 812/5/S8 | 812/1/S8 | - | - | - | |
| | 158/12/C | 158/12/C/6000 | 40 x 8 mm | 812/6/S | 812/6 | 812/2 | 1819/14 | - | - | |
| | 810/A/3 | 810/A/12 | 40 x 10 mm | - | 812/7 | 812/3 | 1819/15 | - | - | |
| | 810/7/C | 810/7/C/6000 | 40 x 12 mm | - | 1819/25 | 1819/21 | 1819/17 | - | - | |
| | 810/A/4 | 810/A/13 | 40 x 15 mm | - | 812/5/S10 | 812/3/S1 | - | - | - | |
| | 158/47/C | 158/47/C/6000 | 45 x 10 mm | - | 1819/27 | 1819/23 | 1819/19 | - | - | |
| | 158/45/C | 158/45/C/6000 | 50 x 8 mm | - | 1819/26 | 1819/22 | 1819/19 | - | - | |
| | 810/A/5 | 810/A/14 | 50 x 10 mm | - | 812/8 | 812/4 | 1819/16 | - | - | |
| | 810/8/C | 810/8/C/6000 | 50 x 12 mm | - | 1819/28 | 1819/24 | 1819/20 | - | - | |
| | 810/A/6 | 810/A/15 | 50 x 15 mm | - | 812/8/S2 | - | - | - | - | |
| 810/A/7 | 810/A/16 | 50 x 20 mm | - | 1819/28/S | 1819/24/S | 1819/20/S | - | - | | |
| 810/A/9 | 810/A/18 | 60 x 20 mm | - | 1819/28/S1 | 1819/24/S1 | - | - | - | | |
| | 810/1 | 810/1/6000 | 20 x 10 mm | - | - | - | - | - | - | |
| | 810/2 | 810/2/6000 | 25 x 12,5 mm | - | - | - | - | - | - | |
| | 810/3 | 810/10 | 30 x 15 mm | 812/5/S | 812/5/S9 | 812/1/S9 | - | - | - | |
| | 810/5 | 810/11 | 40 x 20 mm | - | 812/5/S4 | 812/3/S2 | 1819/17/S | - | - | |
| | 810/12 | 810/12/6000 | 50 x 25 mm | - | 812/5/S6 | 1819/24/S2 | - | - | - | |
| | 810/13 | 810/13/6000 | 60 x 30 mm | - | - | - | - | - | - | |



CURVES FOR HOT ROLLED HANDRAILS - CURVE PER CORRIMANI LAMINATI A CALDO

Tapered manually forged
Rastremato forgiato manualmente

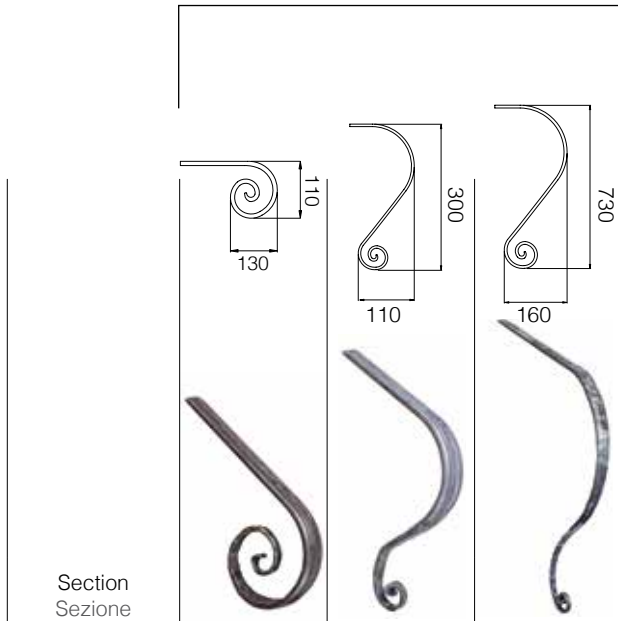

| Section Sezione | Art. | Art. | Art. |
|--------------------|---------|---------|--------|
| ∅ 40 x 11 mm | 1814/17 | 1814/11 | 1814/5 |
| ∅ 45 x 12 mm | 1814/16 | 1814/10 | 1814/4 |
| ∅ 50 x 14 mm | 1814/18 | 1814/12 | 1814/6 |
| ∅ 60 x 16 mm | 1814/15 | 1814/9 | 1814/3 |
| ∅ 25 x 7 mm | - | - | - |
| ∅ 30 x 8 mm | - | - | - |
| ∅ 30 x 10 mm | - | - | - |
| ∅ 35 x 10 mm | - | - | - |
| ∅ 35 x 15 mm | - | - | - |
| ∅ 40 x 8 mm | - | - | - |
| ∅ 40 x 10 mm | - | - | - |
| ∅ 40 x 12 mm | - | - | - |
| ∅ 40 x 15 mm | - | - | - |
| ∅ 45 x 10 mm | - | - | - |
| ∅ 50 x 8 mm | - | - | - |
| ∅ 50 x 10 mm | - | - | - |
| ∅ 50 x 12 mm | - | - | - |
| ∅ 50 x 15 mm | - | - | - |
| ∅ 50 x 20 mm | - | - | - |
| ∅ 60 x 20 mm | - | - | - |
| ∅ 20 x 10 mm | - | - | - |
| ∅ 25 x 12,5 mm | - | - | - |
| ∅ 30 x 15 mm | - | - | - |
| ∅ 40 x 20 mm | - | - | - |
| ∅ 50 x 25 mm | - | - | - |
| ∅ 60 x 30 mm | - | - | - |

The end piece of a handrail is a highly characterising element. Don't allow the processing and beauty of your handrail get spoiled by an unsightly welding between the end and the long bar. The extendable ends resolve this problem: starting with 3 meters rails, we can create the end you need.

La partenza di un corrimano è un elemento altamente caratterizzante. Non lasciare che la lavorazione e la bellezza del tuo corrimano venga interrotta da una antiestetica saldatura tra la partenza e la barra lunga. Le partenze allungate risolvono questo problema: partendo da una barra di 3 metri realizzeremo la partenza che ti serve.



Variable length depending on which end you select
Lunghezza variabile in base alla partenza scelta

Add "/XL" at the end of the code for your end piece to order extra-long. You'll achieve an excellent result, without any visible welds.

Aggiungi "/XL" alla fine del codice della tua partenza per ordinare la versione extra lunga. Otterrai un risultato eccellente, senza saldature.

Example - Esempio

1817/9/XL = Extended version
= Versione allungata



Pag. 247

You can find our supports and accessories in section 17
Nel capitolo 17 troverai reggicorrimani e accessori

END PIECES FOR HOT ROLLED HANDRAILS - PARTENZE PER CORRIMANI LAMINATI A CALDO



Variable length depending on which end you select.
Lunghezza variabile in base alla partenza scelta.

Add "/XL" at the end of the code for your end piece to order extra-long. You'll achieve an excellent result, without any visible welds.

Aggiungi "/XL" alla fine del codice della tua partenza per ordinare la versione extra lunga. Otterrai un risultato eccellente, senza saldature.

Hot hammered - Coniato a caldo

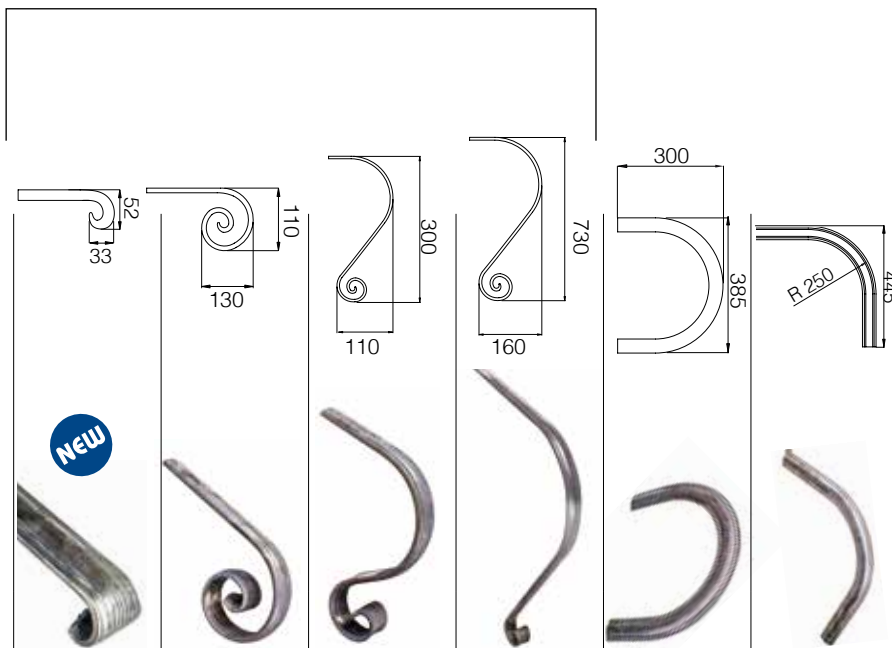

Example - Esempio

812/14/XL = Extended version
= Versione allungata

| | | | | | | | | |
|-----------|------|-------------------|------|---------------|--------|--------|--------|--------|
| L 4000 mm | | Section - Sezione | | | | | | |
| Art. | Art. | | Art. | Art. | Art. | Art. | Art. | Art. |
| 811/2 | - | ∅ 58 x 16 mm | - | 812/14 | 1817/7 | 1817/4 | 1822/6 | 1817/7 |

L 3000 mm L 6000 mm

| | | | | | | | | |
|-------|-------|------------------------|----------|--------|---------|---------|---|---|
| | | ∅ A45 x B15 x C26,5 mm | - | 812/13 | 1377/41 | - | - | - |
| 811/4 | 811/7 | | | 812/13 | 1377/41 | - | - | - |
| | | ∅ A49 x B19 x C28 mm | - | 812/15 | 1377/42 | 1819/12 | - | - |
| 811/5 | 811/8 | | | 812/15 | 1377/42 | 1819/12 | - | - |
| | | ∅ A56 x B21 x C32,5 mm | 812/12/S | 812/12 | 1377/40 | 1819/10 | - | - |
| 811/3 | 811/6 | | 812/12/S | 812/12 | 1377/40 | 1819/10 | - | - |

L 3000 mm L 6000 mm

| | | | | | | | | |
|----------|----------|--------------|---|---------|--------|--------|---|---|
| | | ∅ 44 x 14 mm | - | 1377/18 | 1377/5 | 1819/5 | - | - |
| 810/B/19 | 810/B/20 | | | 1377/18 | 1377/5 | 1819/5 | - | - |

L 3650 mm

| | | | | | | | | |
|---------|---|-------------|----------|---------|---------|--------|--------|---------|
| | - | ∅ 43 x 7 mm | - | 1818/15 | 114/B/1 | 1818/5 | 1822/7 | 1822/18 |
| 114/A/1 | - | | | 1818/15 | 114/B/1 | 1818/5 | 1822/7 | 1822/18 |
| | - | ∅ 53 x 9 mm | 812/16/S | 1818/16 | 114/B/2 | 1818/6 | 1822/8 | 1822/19 |
| 114/A/2 | - | | 812/16/S | 1818/16 | 114/B/2 | 1818/6 | 1822/8 | 1822/19 |

END PIECES FOR COLD ROLLED HANDRAILS - PARTENZE PER CORRIMANI LAMINATO A FREDDO

L 2500 mm

| | | | | | | | | |
|-------|---|--------------|---|---|---|---|--------|---------|
| | - | ∅ 56 x 17 mm | - | - | - | - | 1822/5 | 1822/16 |
| 811/1 | - | | | - | - | - | 1822/5 | 1822/16 |

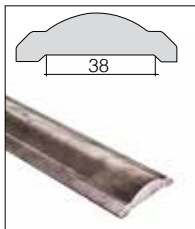
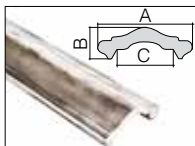

CURVES FOR HOT ROLLED HANDRAILS
CURVE PER CORRIMANI LAMINATI A CALDO

Tapered manually forged
 Rastremato forgiato manualmente

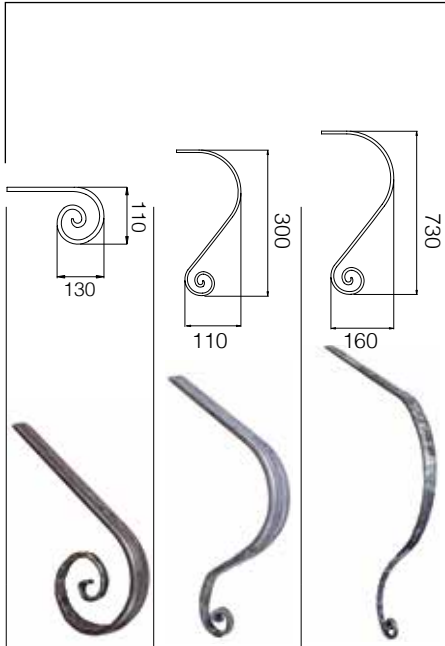

Section - Sezione

| | | | |
|--------------|---------|--------|--------|
| | Art. | Art. | Art. |
| ☒ 58 x 16 mm | 1814/14 | 1814/8 | 1814/2 |

| | | | |
|------------------------|---|---|---|
| ☒ A45 x B15 x C26,5 mm | - | - | - |
| ☒ A49 x B19 x C28 mm | - | - | - |
| ☒ A56 x B21 x C32,5 mm | - | - | - |

| | | | |
|--------------|---|---|---|
| ☒ 44 x 14 mm | - | - | - |
|--------------|---|---|---|

| | | | |
|-------------|---|---|---|
| ☒ 43 x 7 mm | - | - | - |
| ☒ 53 x 9 mm | - | - | - |

END PIECES FOR COLD ROLLED HANDRAILS
PARTENZE PER CORRIMANI LAMINATO A FREDDO

| | | | |
|--------------|-------|--------|--------|
| ☒ 56 x 17 mm | 812/9 | 812/10 | 812/11 |
|--------------|-------|--------|--------|



**END PIECES FOR MANUALLY FORGED HANDRAILS
PARTENZE PER CORRIMANI FORGIATI MANUALMENTE**



Variable length depending on which end you select
Lunghezza variabile in base alla partenza scelta

Add "/XL" at the end of the code for your end piece to order extra-long. You'll achieve an excellent result, without any visible welds.

Aggiungi "/XL" alla fine del codice della tua partenza per ordinare la versione extra lunga. Otterrai un risultato eccellente, senza saldature.

Hot hammered - Coniati a caldo



Example - Esempio

1820/11/XL = Extended version
= Versione allungata



| | | | | | | | |
|-----------|---|-------------------|------|------|------|------|--|
| L 2000 mm | | Section - Sezione | | | | | |
| Art. | | | Art. | Art. | Art. | Art. | |
| 114/1 | - | ∅ 56 x 14 mm | - | - | - | - | |

L 2000 mm



| | | | | | | | |
|-------|---|--------------|---|---|---|---|--|
| 114/2 | - | ∅ 58 x 17 mm | - | - | - | - | |
|-------|---|--------------|---|---|---|---|--|

**END PIECES FOR COLD ROLLED HANDRAILS
PARTENZE PER CORRIMANI LAMINATO A FREDDO**

L 3000 mm L 6000 mm

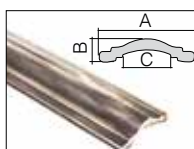

| | | | | | | | |
|---------|----------|--------------------------|------------|----------|-----------|---------|--|
| 811/5/T | 811/8/T | ∅ A50 x B14 x C25,4 mm | - | 812/15/T | 1377/42/T | 1820/11 | |
| 811/3/T | 811/6/T | ∅ A59 x B16,5 x C32,5 mm | 812/12/T/S | 812/12/T | 1377/10/T | 1820/9 | |
| 811/9/T | 811/10/T | ∅ A80 x B18,5 x C41 mm | - | 1820/14 | 1820/13 | 1820/12 | |
| 811/4/T | 811/7/T | ∅ A41 x B11 x C25,5 mm | - | 812/13/T | 1377/41/T | 1820/10 | |

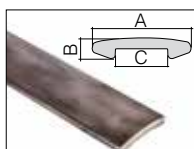

L 3000 mm L 6000 mm

| | | | | | | | |
|------------|------------|-------------------------|---|-----------|----------|--------|--|
| 810/B/13/T | 810/B/16/T | ∅ A40 x B8,5 x C20,7 mm | - | 1377/20/T | 1377/7/T | 1820/5 | |
| 810/B/14/T | 810/B/17/T | ∅ A45 x B9 x C20,8 mm | - | 1377/21/T | 1377/8/T | 1820/6 | |
| 810/B/15/T | 810/B/18/T | ∅ A50 x B9 x C25,7 mm | - | 1377/22/T | 1377/9/T | 1820/7 | |

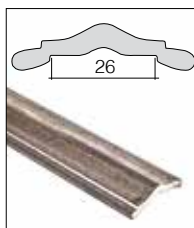

L 3000 mm L 6000 mm

| | | | | | | | |
|------------|------------|--------------|---|-----------|----------|--------|--|
| 810/B/19/T | 810/B/20/T | ∅ 43 x 11 mm | - | 1377/18/T | 1377/5/T | 1820/8 | |
|------------|------------|--------------|---|-----------|----------|--------|--|

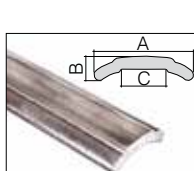

L 3000 mm L 6000 mm

| | | | | | | | |
|-----------|-----------|------------------------|---|-----------|----------|--------|--|
| 810/B/1/T | 810/B/5/T | ∅ A35 x B9 x C15 mm | - | 1377/14/T | 1377/1/T | 1820/1 | |
| 810/B/2/T | 810/B/6/T | ∅ A41 x B9 x C21,1 mm | - | 1377/15/T | 1377/2/T | 1820/2 | |
| 810/B/3/T | 810/B/7/T | ∅ A45 x B14 x C20,8 mm | - | 1377/16/T | 1377/3/T | 1820/3 | |
| 810/B/4/T | 810/B/8/T | ∅ A50 x B14 x C20,7 mm | - | 1377/17/T | 1377/4/T | 1820/4 | |

**END PIECES FOR MANUALLY FORGED HANDRAILS
PARTENZE PER CORRIMANI FORGIATI MANUALMENTE**

Tapered manually forged
Rastremato forgiato manualmente

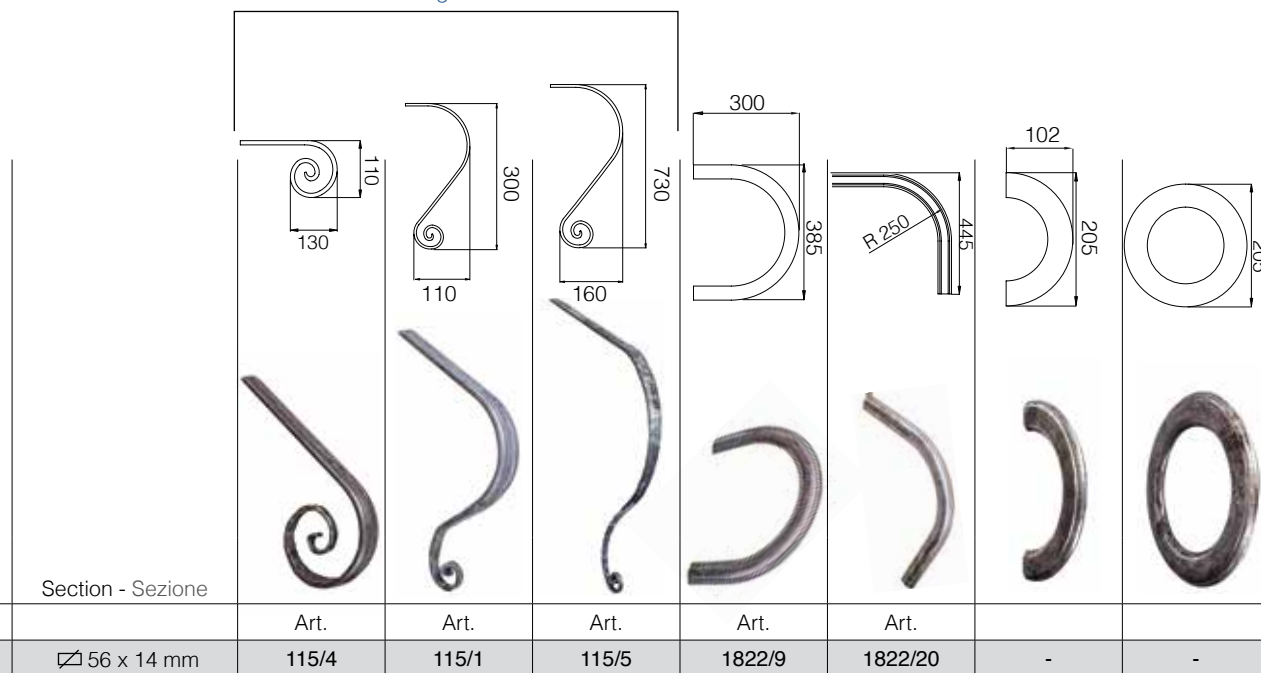

Section - Sezione

| | | | | | | | | |
|--------------|-------|-------|---------|---------|---------|------|---|---|
| | Art. | Art. | Art. | Art. | Art. | Art. | - | - |
| ∅ 56 x 14 mm | 115/4 | 115/1 | 115/5 | 1822/9 | 1822/20 | - | - | - |
| ∅ 58 x 17 mm | 115/3 | 115/2 | 114/B/3 | 1822/10 | 1822/21 | - | - | - |

**END PIECES FOR COLD ROLLED HANDRAILS
PARTENZE PER CORRIMANI LAMINATO A FREDDO**

| | | | | | | | |
|--------------------------|---|---|---|---|---|---------|---------|
| ∅ A50 x B14 x C25,4 mm | - | - | - | - | - | 1825/28 | 1825/18 |
| ∅ A59 x B16,5 x C32,5 mm | - | - | - | - | - | - | 1825/16 |
| ∅ A80 x B18,5 x C41 mm | - | - | - | - | - | 1825/27 | 1825/17 |
| ∅ A41 x B11 x C25,5 mm | - | - | - | - | - | - | - |

| | | | | | | | |
|-------------------------|---|---|---|---|---|---------|---------|
| ∅ A40 x B8,5 x C20,7 mm | - | - | - | - | - | 1825/23 | 1825/13 |
| ∅ A45 x B9 x C20,8 mm | - | - | - | - | - | 1825/24 | 1825/14 |
| ∅ A50 x B9 x C25,7 mm | - | - | - | - | - | 1825/25 | 1825/15 |

| | | | | | | | |
|--------------|---|---|---|---|---|---|---|
| ∅ 43 x 11 mm | - | - | - | - | - | - | - |
|--------------|---|---|---|---|---|---|---|

| | | | | | | | |
|------------------------|---|---|---|---|---|---------|---------|
| ∅ A35 x B9 x C15 mm | - | - | - | - | - | 1825/19 | 1825/9 |
| ∅ A41 x B9 x C21,1 mm | - | - | - | - | - | 1825/20 | 1825/10 |
| ∅ A45 x B14 x C20,8 mm | - | - | - | - | - | 1825/21 | 1825/11 |
| ∅ A50 x B14 x C20,7 mm | - | - | - | - | - | 1825/22 | 1825/12 |

ENDS FOR COLD LAMINATED HANDRAILS
PARTENZE PER CORRIMANI LAMINATI A FREDDO



Variable length depending on which end you select
Lunghezza variabile in base alla partenza scelta

Add "/XL" at the end of the code for your end piece to order extra-long. You'll achieve an excellent result, without any visible welds.

Aggiungi "/XL" alla fine del codice della tua partenza per ordinare la versione extra lunga. Otterrai un risultato eccellente, senza saldature.

Example - Esempio

116/10/XL = Extended version
= Versione allungata

Hot hammered - Coniato a caldo

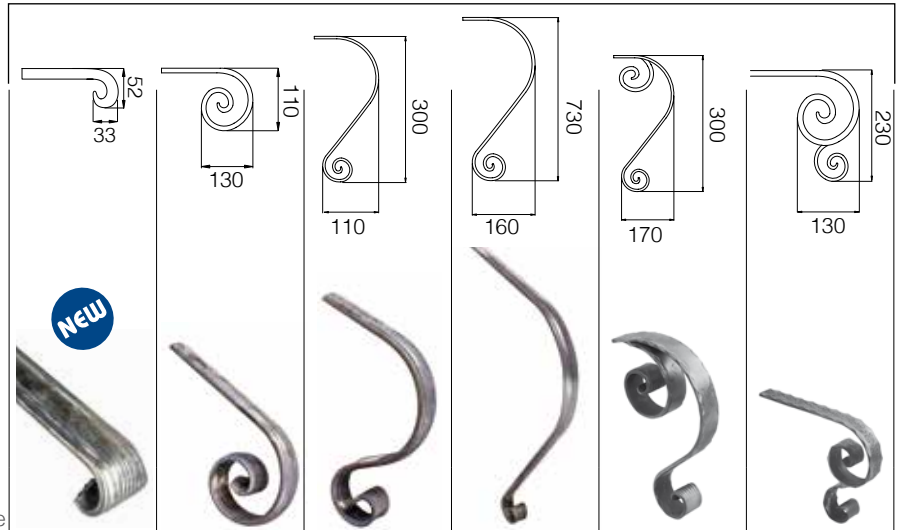

| L 3000 mm | L 6000 mm | Section - Sezione |
|-----------|-----------|-------------------|
| Art. | Art. | |
| 1837/8 | - | ∅ 57 x 7 mm |



| | | | | | | | | |
|--------|-------------|-------------|-----------|---------|---------|--------|-----------|----------|
| 114/9 | 114/9/6000 | ∅ 30 x 8 mm | 1818/11/S | 1818/11 | 1818/7 | 1818/1 | - | - |
| 1838/2 | 1838/2/6000 | ∅ 40 x 8 mm | - | 1818/12 | 1818/8 | 1818/2 | 1378/14/S | 1378/5/S |
| 1838/3 | 1838/3/6000 | ∅ 50 x 8 mm | - | 1818/13 | 1818/9 | 1818/3 | - | - |
| 1838/4 | 1838/4/6000 | ∅ 60 x 8 mm | - | 1818/14 | 1818/10 | 1818/4 | - | - |



| | | | | | | | | |
|---|-------------|-------------|---|----------|---------|---------|---------|--------|
| 114/10 | 114/10/6000 | ∅ 40 x 8 mm | - | 116/14 | 116/6 | 114/B/9 | 1378/15 | 1378/6 |
| Wavy grooves - Rigature ondulate | | | | | | | | |
| 114/10/S | - | ∅ 40 x 8 mm | - | 116/14/S | 116/6/S | - | - | - |
| Straight grooves - Rigature dritte | | | | | | | | |



| | | | | | | | | |
|--------|-------------|-------------|-----------|-----------|----------|------------|------------|----------|
| 114/5 | 114/5/6000 | ∅ 40 x 8 mm | 116/10/S7 | 116/10 | 116/2 | 114/B/5 | 1378/11 | 1378/2 |
| 114/13 | 114/13/6000 | ∅ 50 x 8 mm | - | 116/10/S1 | 116/2/S1 | 114/B/5/S | 1378/11/S1 | 1378/2/S |
| 114/14 | 114/14/6000 | ∅ 40 x 6 mm | - | 116/10/S3 | 116/2/S2 | 114/B/5/S3 | - | - |



| | | | | | | | | |
|--------|-------------|-------------|---|-----------|-----------|----------|---------|--------|
| 118/14 | 118/14/6000 | ∅ 40 x 8 mm | - | 116/37 | 116/36 | 114/B/12 | 1378/18 | 1378/9 |
| 118/13 | 118/13/6000 | ∅ 30 x 8 mm | - | 116/37/S1 | 116/36/S1 | - | - | - |



ENDS FOR COLD LAMINATED HANDRAILS
PARTENZE PER CORRIMANI LAMINATI A FREDDO

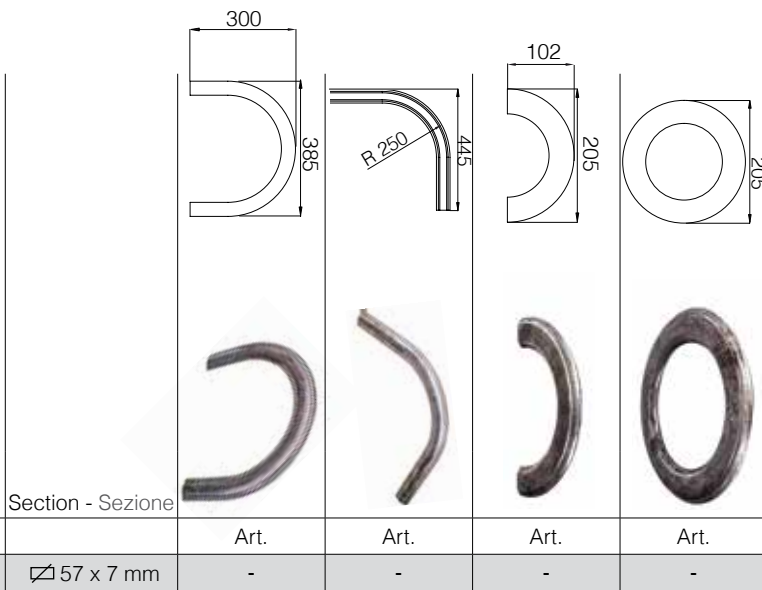

Section - Sezione

| | | | | |
|-------------|------|------|------|------|
| | Art. | Art. | Art. | Art. |
| ∅ 57 x 7 mm | - | - | - | - |

| | | | | |
|-------------|----------|--------|---|---|
| ∅ 30 x 8 mm | 1825/9 | 1825/5 | - | - |
| ∅ 40 x 8 mm | 1825/2 | 1825/6 | - | - |
| ∅ 50 x 8 mm | 1825/3 | 1825/7 | - | - |
| ∅ 60 x 8 mm | 1825/4 | 1825/8 | - | - |
| ∅ 40 x 8 mm | 116/A/3 | 116/30 | - | - |
| ∅ 40 x 8 mm | - | - | - | - |
| ∅ 40 x 8 mm | 116/A/9 | 116/26 | - | - |
| ∅ 50 x 8 mm | - | - | - | - |
| ∅ 40 x 6 mm | - | - | - | - |
| ∅ 40 x 8 mm | 116/A/16 | 116/39 | - | - |
| ∅ 30 x 8 mm | - | - | - | - |



Pag. 247

You can find our supports and accessories in section 17
 Nel capitolo 17 troverai reggicorrimani e accessori



Hot hammered - Coniato a caldo



Variable length depending on which end you select
Lunghezza variabile in base alla partenza scelta

Add "/XL" at the end of the code for your end piece to order extra-long. You'll achieve an excellent result, without any visible welds.

Aggiungi "/XL" alla fine del codice della tua partenza per ordinare la versione extra lunga. Otterrai un risultato eccellente, senza saldature.

Example - Esempio

116/11/XL = Extended version
= Versione allungata

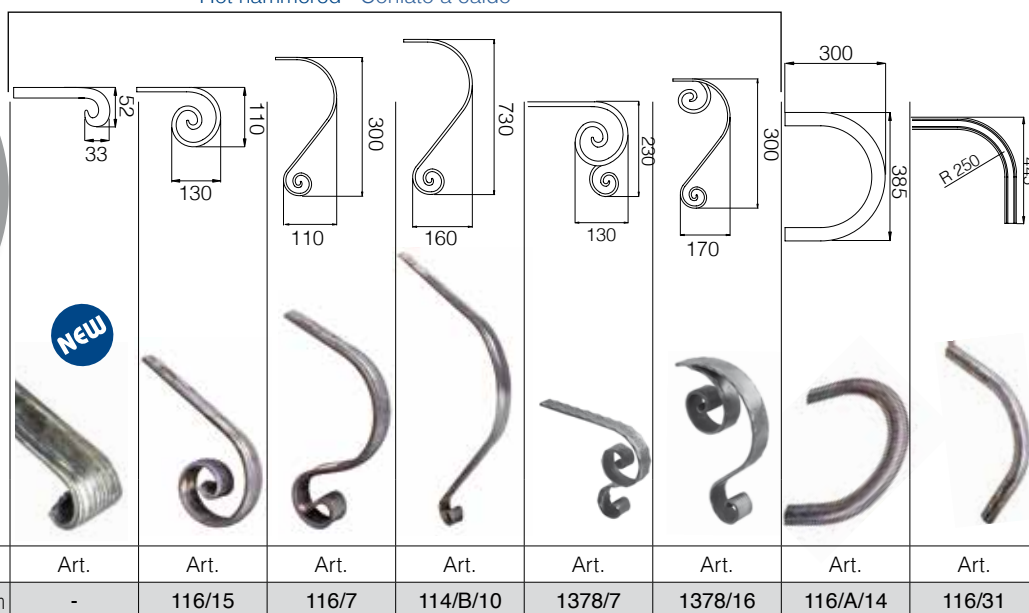

| | L 3000 mm | L 6000 mm | Sezione | | | | | | | | |
|--|-------------|------------------|-----------|---|--------|-------|----------|--------|---------|----------|--------|
| | Art. 114/11 | Art. 114/11/6000 | 40 x 8 mm | - | 116/15 | 116/7 | 114/B/10 | 1378/7 | 1378/16 | 116/A/14 | 116/31 |
| | Art. 114/12 | Art. 114/12/6000 | 40 x 8 mm | - | 116/16 | 116/8 | 114/B/11 | 1378/8 | 1378/17 | 116/A/15 | 116/32 |
| | Art. 114/8 | Art. 114/8/6000 | 40 x 8 mm | - | 116/13 | 116/5 | 114/B/8 | 1378/5 | 1378/14 | 116/A/12 | 116/29 |
| | Art. 114/6 | Art. 114/6/6000 | 40 x 8 mm | - | 116/11 | 116/3 | 114/B/6 | 1378/3 | 1378/12 | 116/A/10 | 116/27 |
| | Art. 114/7 | Art. 114/7/6000 | 40 x 8 mm | - | 116/12 | 116/4 | 114/B/7 | 1378/4 | 1378/13 | 116/A/11 | 116/28 |
| | Art. 114/4 | Art. 114/4/6000 | 40 x 8 mm | - | 116/9 | 116/1 | 114/B/4 | 1378/1 | 1378/10 | 116/A/8 | 116/25 |

Slotted steel for plastic, moldable handrail
Ferro dentellato per corrimano in plastica modellabile
Art. 118/F/9



Art. 118/F/10
40 x 8 mm
L 1500 mm

Moldable plastic handrail Rolls of 25 metres
Plastica modellabile Rotoli da 25 mt

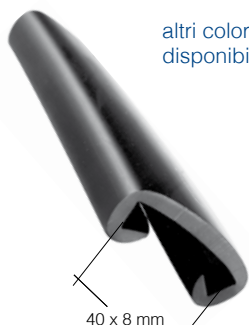

Art. 118/F/9
black - nero
for/per 40 x 8 mm

altri colori disponibili / another colors available

- gold / oro
- blue / blu
- white / bianco

Tubular iron handrail 1.5 mm thick.
Corrimano tubolare in ferro spessore 1,5 mm

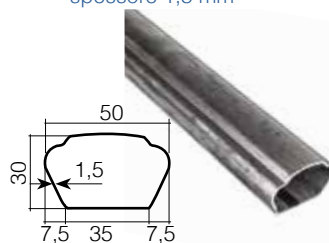

Art. 118/F/7/3000
50 x 30 mm
L 3000 mm
Art. 118/F/7
50 x 30 mm
L 6000 mm

Tubular steel handrail 1.5 mm thick.
Corrimano tubolare in ferro spessore 1,5 mm

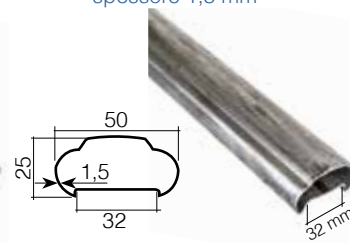

Art. 118/F/8/3000
50 x 25 mm
L 3000 mm
Art. 118/F/8
50 x 25 mm
L 6000 mm

HANDRAIL PROFILES COLD ROLLED CORRIMANI PROFILI LAMINATI A FREDDO

Handrails and End pieces - Corrimani e Partenze

Worked on one side - Lavorato su un lato

| Section Sezione |  |  |  |  |  |  |  |
|--------------------|---|---|---|--|---|---|---|
| | L 4000 mm | L 3000 mm | L 3000 mm | L 3000 mm | L 3000 mm | L 3000 mm | L 3000 mm |
| | Art. | Art. | Art. | Art. | Art. | Art. | Art. |
| ∅ 16 x 3 mm | 1839/25 | - | - | - | - | - | - |
| ∅ 30 x 5 mm | - | 1838/8 | - | - | - | - | - |
| ∅ 31 x 5 mm | - | - | 1834/2 | 1834/3 | - | - | 1834/4 |
| ∅ 32 x 5 mm | - | - | - | - | 1834/1 | - | - |
| ∅ 32 x 6 mm | - | - | - | - | - | 1834/9 | - |
| | L 6000 mm | L 6000 mm | L 6000 mm | L 6000 mm | L 6000 mm | L 6000 mm | L 6000 mm |
| ∅ 16 x 3 mm | - | - | - | - | - | - | - |
| ∅ 30 x 5 mm | - | 1838/8/6000 | - | - | - | - | - |
| ∅ 31 x 5 mm | - | - | 1834/2/6000 | 1834/3/6000 | - | - | 1834/4/6000 |
| ∅ 32 x 5 mm | - | - | - | - | 1834/1/6000 | - | - |
| ∅ 32 x 6 mm | - | - | - | - | - | 1834/9/6000 | - |

| Section Sezione |  |  |  |  |  |  |
|--------------------|---|---|---|--|---|---|
| | L 3000 mm | L 3000 mm | L 3000 mm | L 3000 mm | L 3000 mm | L 3000 mm |
| | Art. | Art. | Art. | Art. | Art. | Art. |
| ∅ 17 x 5 mm | - | - | - | - | - | 114/A/6 |
| ∅ 30 x 5 mm | - | - | - | - | 114/A/5 | - |
| ∅ 31 x 5 mm | - | 1834/6 | - | - | - | - |
| ∅ 32 x 6 mm | - | - | 1834/7 | - | - | - |
| ∅ 32 x 7 mm | 1834/5 | - | - | - | - | - |
| ∅ 32 x 9 mm | - | - | - | 1834/8 | - | - |
| ∅ 57 x 17 mm | - | - | - | - | - | - |
| | L 6000 mm | L 6000 mm | L 6000 mm | L 6000 mm | L 6000 mm | L 6000 mm |
| ∅ 17 x 5 mm | - | - | - | - | - | 114/A/6/6000 |
| ∅ 30 x 5 mm | - | - | - | - | 114/A/5/6000 | - |
| ∅ 31 x 5 mm | - | 1834/6/6000 | - | - | - | - |
| ∅ 32 x 6 mm | - | - | - | - | - | - |
| ∅ 32 x 7 mm | 1834/5/6000 | - | 1834/7/6000 | - | - | - |
| ∅ 32 x 9 mm | - | - | - | 1834/8/6000 | - | - |
| ∅ 57 x 17 mm | - | - | - | - | - | - |

| Section Sezione |  |  |  |  |
|--------------------|---|---|---|--|
| | L 3000 mm | L 3000 mm | L 2000 mm | L 2000 mm |
| | Art. | Art. | Art. | Art. |
| ∅ 20 x 4 mm | - | 1837/5 | - | - |
| ∅ 23 x 4 mm | 1837/1 | - | - | - |
| ∅ 27 x 5 mm | 1837/2 | - | - | - |
| ∅ 30 x 6 mm | - | 1837/6 | - | - |
| ∅ 37 x 7 mm | 1837/3 | - | - | - |
| ∅ 41 x 8 mm | 1837/4 | - | - | - |
| ∅ 57 x 17 mm | - | - | - | - |
| ∅ 100 x 8 mm | - | - | 1370/1 | 1370/3 |
| ∅ 120 x 8 mm | - | - | 1370/2 | 1370/4 |
| | L 6000 mm | L 6000 mm | L 6000 mm | L 6000 mm |
| ∅ 20 x 4 mm | 1837/1/6000 | - | - | - |
| ∅ 23 x 4 mm | 1837/2/6000 | - | - | - |
| ∅ 27 x 5 mm | - | 1837/6/6000 | - | - |
| ∅ 30 x 6 mm | 1837/3/6000 | - | - | - |
| ∅ 37 x 7 mm | 1837/4/6000 | - | - | - |
| ∅ 41 x 8 mm | - | - | - | - |
| ∅ 57 x 17 mm | - | - | - | - |
| ∅ 100 x 8 mm | - | - | 1370/1/6000 | 1370/3/6000 |
| ∅ 120 x 8 mm | - | - | 1370/2/6000 | 1370/4/6000 |

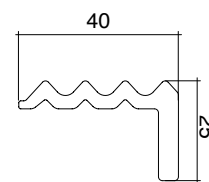

L-Profile
Profilo ad elle



Rolled only on the 40 mm side
Lavorato solo sul lato da 40 mm

Art. 810/A/19/T
∅ 25 x 40 mm
L 3000 mm

Art. 810/A/20/T
∅ 25 x 40 mm
L 6000 mm

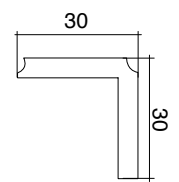

Angular profile
Profilo angolare



Only hammered on one side / 2 angles
Lavorato solo su un lato / 2 angoli

Art. 1373/1
30 x 30 x 4 mm
L 3000 mm

Art. 1373/1/6000
30 x 30 x 4 mm
L 6000 mm



| Section Sezione | Twisted to the left Attorcigliatura sinistra | | Twisted to the right Attorcigliatura destra | | Twisted to the left Attorcigliatura sinistra | | Twisted to the right Attorcigliatura destra | |
|--------------------|---|-------------------|--|-------------------|---|-------------------|--|-------------------|
| | L 3000 mm Art. | L 6000 mm Art. | L 3000 mm Art. | L 6000 mm Art. | L 3000 mm Art. | L 6000 mm Art. | L 3000 mm Art. | L 6000 mm Art. |
| ∅ 8 x 8 mm | 118/H/18 | 118/H/7 | - | - | - | - | - | - |
| ∅ 10 x 10 mm | 118/H/19 | 118/H/8 | - | - | - | - | - | - |
| ∅ 12 x 12 mm | 118/H/20 | 118/H/9 | - | - | - | - | - | - |
| ∅ 14 x 14 mm | 118/H/21 | 118/H/10 | - | - | - | - | - | - |
| ∅ 16 x 16 mm | 118/H/22 | 118/H/11 | - | - | - | - | - | - |
| ∅ 18 x 18 mm | 118/H/23 | 118/H/12 | - | - | - | - | - | - |
| ∅ 20 x 20 mm | 118/H/24 | 118/H/13 | - | - | - | - | - | - |
| ∅ 25 x 25 mm | 118/H/25 | 118/H/14 | - | - | - | - | - | - |
| ∅ 30 x 30 mm | 118/H/26 | 118/H/15 | 1806/19 | 1806/22 | - | - | - | - |
| ∅ 40 x 40 mm | 1806/14 | 1806/16 | 1806/18 | 1806/21 | - | - | - | - |
| ∅ 50 x 50 mm | 1806/13 | 1806/15 | 1806/17 | 1806/20 | - | - | - | - |
| ∇ 20 x 6 mm | - | - | - | - | 118/H/16 | 118/H/5 | - | - |
| ∇ 30 x 8 mm | - | - | - | - | 118/H/17 | 118/H/6 | - | - |
| ∇ 50 x 25 mm | - | - | - | - | 1806/24 | 1806/26 | 1806/28 | 1806/30 |
| ∇ 60 x 30 mm | - | - | - | - | 1806/23 | 1806/25 | 1806/27 | 1806/29 |

1 groove on each side
1 solco per lato

3 grooves on each side
3 solchi per lato

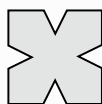

| Section Sezione | Twisted to the left Attorcigliatura sinistra | | Twisted to the right Attorcigliatura destra | | Twisted to the left Attorcigliatura sinistra | | Twisted to the right Attorcigliatura destra | |
|--------------------|---|-------------------|--|-------------------|---|-------------------|--|-------------------|
| | L 3000 mm Art. | L 6000 mm Art. | L 3000 mm Art. | L 6000 mm Art. | L 3000 mm Art. | L 6000 mm Art. | L 3000 mm Art. | L 6000 mm Art. |
| ∅ 30 x 30 mm | 1807/3 | 1807/6 | 1807/9 | 1807/12 | 1807/15 | 1807/18 | 1807/21 | 1807/24 |
| ∅ 40 x 40 mm | 1807/2 | 1807/5 | 1807/8 | 1807/11 | 1807/14 | 1807/17 | 1807/20 | 1807/23 |
| ∅ 50 x 50 mm | 1807/1 | 1807/4 | 1807/7 | 1807/10 | 1807/13 | 1807/16 | 1807/19 | 1807/22 |

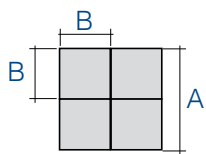

| Section Sezione | Section Sezione | L 2000 mm |
|--------------------|--------------------|-----------|
| A | B | Art. |
| ∅ 12 mm | ∅ 6 mm | 118/F/1 |
| ∅ 14 mm | ∅ 7 mm | - |
| ∅ 16 mm | ∅ 8 mm | 118/F/2 |
| ∅ 18 mm | - | - |
| ∅ 20 mm | ∅ 10 mm | 118/F/3 |
| ∅ 22 mm | - | - |
| ∅ 24 mm | ∅ 12 mm | 118/F/4 |
| ∅ 26 mm | - | - |
| ∅ 28 mm | ∅ 14 mm | 118/F/5 |
| ∅ 30 mm | - | - |

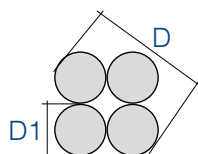

| Section Sezione | Section Sezione | L 2700 mm | L 5400 mm |
|--------------------|--------------------|-----------|------------|
| D | D1 | Art. | |
| ∅ 12 mm | - | - | - |
| ∅ 14 mm | - | - | - |
| ∅ 16 mm | ∅ 6 mm | 119/1 | 119/1/5400 |
| ∅ 18 mm | - | - | - |
| ∅ 20 mm | ∅ 8 mm | 119/2 | 119/2/5400 |
| ∅ 22 mm | - | - | - |
| ∅ 24 mm | - | - | - |
| ∅ 26 mm | - | - | - |
| ∅ 28 mm | - | - | - |
| ∅ 30 mm | ∅ 12 mm | 119/3 | 119/3/5400 |

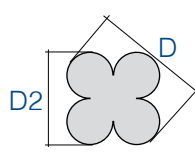

| Section Sezione | L 3000 mm |
|--------------------|-----------|
| D2 | Art. |
| ∅ 12 mm | 626/3 |
| ∅ 14 mm | 626/4 |
| ∅ 16 mm | 626/5 |
| ∅ 18 mm | 626/6 |
| ∅ 20 mm | 626/7 |
| ∅ 22 mm | 626/8 |
| ∅ 26 mm | 626/9 |
| - | - |
| - | - |
| - | - |

Twisted bars - Torciglioni

Grooved tube Tubo rigato



∅ 40 mm
Thickn.-Spess. 2 mm
Art. 1794/9
L 3000 mm

Art. 1794/9/6000
L 6000 mm

∅ 30 mm
Thickn.-Spess. 1,5 mm
Art. 1794/10
L 3000 mm

Art. 1794/10/6000
L 6000 mm

Twisted tube Tubo attorcigliato

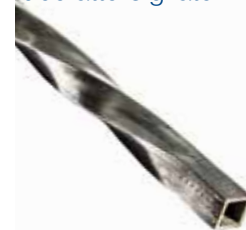

Art. 118/F/6
∅ 20 x 20 mm
L 2000 mm
Thickn.-Spess 2 mm

Hot grooved rope on 4 sides and beveled on 4 angles Fune solcata a caldo 4 lati e smussata 4 angoli

- L 2000 mm
- Art. 117/10**
- ∅ 14 x 14 mm
- Art. 117/11**
- ∅ 16 x 16 mm
- Art. 117/12**
- ∅ 18 x 18 mm
- Art. 117/13**
- ∅ 20 x 20 mm
- Art. 117/14**
- ∅ 30 x 30 mm

Art. 626/1
40 x 40 mm
∅ 3,5 mm
L 2900 mm

Art. 626/2
50 x 50 mm
∅ 5 mm
L 2900 mm



Twisted cross iron Ferro croce attorcigliato



Collars - Fascette

HOT ROLLED PROFILES - PROFILI LAMINATI A CALDO



Art. 158/3
 ▧ 14 x 4 mm
 L 4000 mm

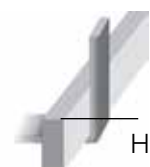

| | | Art. | |
|------------|--|--------|--|
| H 8 mm | for-per 2 bars-barre 8 x 8 mm | 158/20 | |
| | for-per 4 bars-barre 8 x 8 mm | 158/21 | |
| | for-per 3 bars-barre 8 x 8 mm | 158/22 | |
| H 10 mm | for-per 2 bars-barre 10 x 5 mm | 158/23 | |
| | for-per 3 bars-barre 10 x 10 mm | 158/24 | |
| | for-per 2 bars-barre 10 x 10 mm | 158/25 | |
| | for-per 8 x 8 mm + 2 bars-barre 10 x 5 mm | 1848/2 | |
| H 12 mm | for-per 3 bars-barre 10 x 5 mm | 1848/6 | |
| | for-per 2 bars-barre 12 x 6 mm | 158/26 | |
| | for-per 3 bars-barre 12 x 6 mm | 158/27 | |
| | for-per 4 bars-barre 12 x 6 mm | 158/28 | |
| | for-per 6 bars-barre 12 x 6 mm | 158/29 | |
| | for-per 2 bars-barre 12 x 12 mm | 158/30 | |
| | for-per round-tondo 16 mm + 2 bars-barre 12 x 6 mm | 1848/3 | |
| | for-per 5 bars-barre 12 x 6 mm | 1848/4 | |
| H 16 mm | for-per 16 x 16 mm + 2 bars-barre 16 x 8 mm | 1848/1 | |
| H 20 mm | for-per 2 barre 20 x 6 mm | 1848/5 | |

HOT ROLLED PROFILES - PROFILI LAMINATI A CALDO

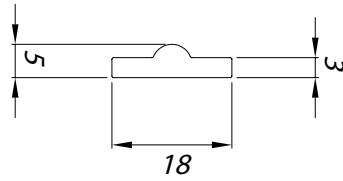

Art. 158/4
 ▽ 18 x 5 mm
 L 4000 mm

Art.

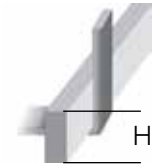

| | | | |
|---|--|---------|--|
| H 12 mm | for-per 2 bars-barre 12 x 12 mm | 85/8 | |
| | per 3 bars-barre 12 x 12 mm | 85/9 | |
| | for-per 2 bars-barre 12 x 6 mm | 158/31 | |
| | for-per 4 bars-barre 12 x 12 mm | 158/32 | |
| | for-per 5 bars-barre x 6 mm | 158/33 | |
| | for-per 12 x 12 mm + 4 bars-barre 12 x 6 mm | 1848/11 | |
| for-per 12 x 12 mm + 3 bars-barre 12 x 6 mm | 1848/12 | | |
| H 14 mm | for-per 14 x 14 mm + 2 bars-barre 14 x 8 mm | 181/7 | |
| | for-per 14 x 14 mm + 1 bar-barra 14 x 8 mm | 181/8 | |
| | for-per 2 bars-barre 14 x 8 mm | 1848/7 | |
| | for-per 3 bars-barre 14 x 8 mm | 1848/8 | |
| | for-per 14 x 14 mm + 4 bars-barre 12 x 6 mm | 1848/13 | |
| | for-per 3 bars-barre 14 x 14 mm | 1848/15 | |
| H 16 mm | for-per 2 bars-barre 14 x 14 mm + 2 bars-barre 12 x 6 mm | 1848/16 | |
| | for-per 14 x 14 mm + 2 bars-barre 14 x 6 mm | 1848/14 | |
| | for-per 14 x 14 mm + 1 bars-barre 16 x 6 mm | 1848/20 | |
| | for-per 14 x 14 mm + 4 bars-barre 16 x 6 mm | 1848/21 | |
| | for-per 4 bars-barre 16 x 6 mm | 1848/9 | |
| H 25 mm | for-per 16 x 16 mm + 2 bars-barre 16 x 6 mm | 1848/17 | |
| | for-per 1 bar-barra 25 x 25 mm | 1848/18 | |
| H 30 mm | for-per 1 bar-barra 30 x 30 mm | 1848/19 | |
| | for-per 2 bars-barre 30 x 4 mm | 1848/10 | |



Art. 158/1
 ∅ 14 x 4 mm
 L 4000 mm

| Section - Sezione | L 3000 mm | L 4000 mm | L 6000 mm |
|-------------------|-----------|-----------|-----------|
| | Art. | Art. | Art. |
| ∅ 14 x 4 mm | - | 158/1 | - |
| ∅ 18 x 5 mm | - | 158/2 | - |
| ∅ 25 x 8 mm | 158/49 | - | 158/52 |
| ∅ 30 x 8 mm | 158/50 | - | 158/53 |
| ∅ 40 x 8 mm | 158/51 | - | 158/54 |

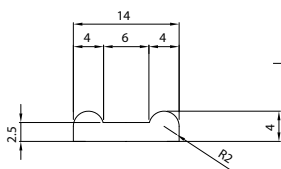

H
12 mm

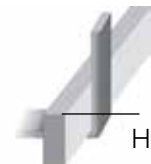

H
14 mm

H
16 mm

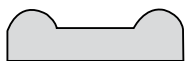

Art. 158/2
 ∅ 18 x 5 mm
 L 4000 mm

| | | Art. | |
|------------|---|---------|--|
| | for-per 4 bars-barre 6 x 6 mm | 158/13 | |
| | for-per 2 bars-barre 12 x 6 mm | 158/14 | |
| | for-per 3 bars-barre 12 x 6 mm | 158/15 | |
| | for-per 4 bars-barre 12 x 6 mm | 158/16 | |
| | for-per 6 bars-barre 12 x 6 mm | 158/17 | |
| | for-per 5 bars-barre 12 x 6 mm | 1851/1 | |
| | for-per 2 bars-barre ∅ 12 mm | 1851/2 | |
| | for-per 3 bars-barre ∅ 12 mm | 1851/3 | |
| | for-per 14 x 14 mm + 2 bars-barre 12 x 6 mm | 1851/5 | |
| | for-per 14 x 14 mm + 4 bars-barre 12 x 6 mm | 1851/6 | |
| | for-per 1 bar-barra 14 x 14 mm | 1851/4 | |
| | for-per 16 x 16 mm + 2 bars-barre 16 x 6 mm | 1851/7 | |
| | for-per 16 x 16 mm + 4 bars-barre 16 x 6 mm | 1851/8 | |
| | for-per 16 x 16 mm + 2 bars-barre 16 x 4 mm | 1851/9 | |
| | for-per 16 x 16 mm + 4 bars-barre 16 x 4 mm | 1851/10 | |
| | for-per 2 bars-barre 16 x 8 mm | 1851/11 | |
| | for-per 3 bars-barre 16 x 8 mm | 1851/12 | |
| | for-per 1 bar-barra 16 x 16 mm | 1851/13 | |
| | for-per 4 bars-barre 10 x 10 mm | 158/18 | |
| H 18 mm | for-per 1 bar-barra 10 x 10 mm | 158/19 | |
| H 25 mm | for-per 2 bars-barre 25 x 12 mm | 1851/26 | |
| | for-per 2 bars-barre 12 x 12 mm | 1851/27 | |
| | for-per 3 bars-barre 16 x 16 mm | 1851/28 | |
| | for-per 1 bar-barra 25 x 25 mm | 1851/29 | |
| | for-per 1 bar-barra 30 x 30 mm | 1851/30 | |

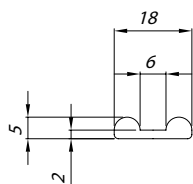

HOT ROLLED PROFILES - PROFILI LAMINATI A CALDO

Collars - Fascette

| Section - Sezione | L 4000 mm |
|-------------------|-----------|
| | Art. |
| ▧ 11 x 3 mm | 158/5 |
| ▧ 14 x 4 mm | 158/6 |
| ▧ 16 x 5 mm | 158/7 |
| ▧ 21 x 6 mm | 158/8 |



Art. 158/5

▧ 11 x 3 mm

L 4000 mm

for-per 2 bars-barre 10 x 5 mm

Art.

158/34

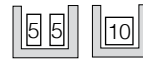

H
10 mm

for-per 3 bars-barre 10 x 5 mm

158/35

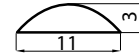
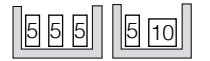

Art. 158/6

▧ 14 x 4 mm

L 4000 mm

for-per 3 bars-barre Ø 10 mm

1846/3

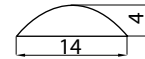
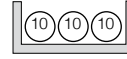

for-per 2 bars-barre Ø 10 mm

1851/17

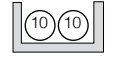

for-per 4 bars-barre 12 x 6 mm

1851/14



for-per 3 bars-barre Ø 12 mm

1851/15



for-per 2 bars-barre Ø 12 mm

1851/16

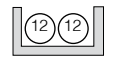

for-per 3 bars-barre 12 x 12 mm

1851/19

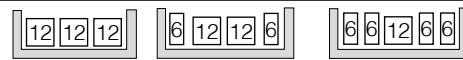

for-per 12 x 12 mm + 2 bars-barre 12 x 6 mm

1851/20

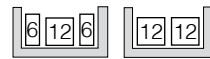

for-per 14 x 14 mm + 2 bars-barre 12 x 6 mm

1851/21

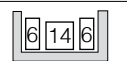

for-per 2 bars-barre dia 14 mm

1851/18/S1

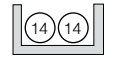

for-per 3 bars-barre dia 14 mm

1851/18

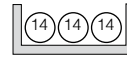

for-per 2 bars-barre 16 x 4 mm

158/36

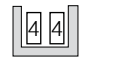

for-per 3 bars-barre 16 x 4 mm

158/37



for-per 1 bar-barra 16 x 16 mm

1851/22



for-per 16 x 16 mm + 1 bar-barra 16 x 6 mm

1851/23



for-per 4 bars-barre 16 x 4 mm

1851/24



for-per 5 bars-barre 16 x 4 mm

1851/25



for-per 2 bars-barre 20 x 4 mm

158/38

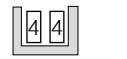

for-per 3 bars-barre 20 x 4 mm

158/39



for-per 2 bars-barre 20 x 6 mm

158/40

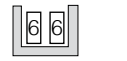

for-per 3 bars-barre 20 x 6 mm

158/41



for-per 2 bars-barre 25 x 4 mm

158/42



for-per 3 bars-barre 25 x 4 mm

158/43



for-per 2 bars-barre 25 x 6 mm

158/44





CUSTOMER SERVICE ASSISTENZA CLIENTI

Our back office staff speaks five languages fluently,
and is at disposal to give you all the information
and support you need.

Il nostro staff di back office parla fluentemente cinque
lingue diverse ed è a vostra disposizione per darvi tutte le
informazioni ed il supporto che vi servono.

+39 0445 580 580

from Monday to Friday
dal Lunedì al Venerdì
08.00 -18.00 (GMT+1)

info@arteferro.com

www.arteferro.com





Arteferro pierced and shaped bars are items with of a wrought iron symbol. Beyond a protective function, they confer a touch of elegance that embellishes the buildings into which they are installed. Arteferro pierced bars are available in lengths up to 3 metres, with diverse machining and drilling. The opening can have either a circular, oval, square or rectangular section which can be made on the side or on the corner, in order to satisfy any aesthetic requirement.

Le barre forate e barre sagomate Arteferro sono degli elementi simbolo del ferro battuto. Al di là della funzione protettiva, conferiscono un tocco di eleganza che impreziosisce l'edificio in cui sono installate. Le barre forate Arteferro sono disponibili con lunghezze fino a 3 metri, con diverse lavorazioni e forature. L'apertura può avere sezione circolare, ovale, quadrata o rettangolare e può essere effettuata sia sul lato sia sullo spigolo, in modo da soddisfare ogni esigenza estetica.

BARRE FORATE - BARRE SAGOMATE PIERCES BARS - SHAPED BARS

2. Pierced bars Shaped bars - Barre forate Barre sagomate

| | | |
|-----------------------------------|------------------------------|--------------|
| A Round pierced bars | Barre forate in tondo | pag.44 |
| B Square pierced bars | Barre forate in quadro | pag.45 |
| C Flat punched bars | Piatti forati | pag.48 |
| D Pierced tubes | Tubi forati | pag.53 |
| E Pierced posts | Montanti forati | pag.54 |
| F Bars with stamped rivets | Barre con ribattini stampati | pag.56 |
| G Shaped bars | Barre sagomate | pag.59 |

Select the section first, then the type of hole and technical details (section, hole size, pitch, distance, no. of holes) At this point, identifying the finish will be easy.

Scegli prima la sezione e poi il tipo di foro e i dettagli tecnici (sezione, dimensione foro, interasse, luce, n. fori) A questo punto, individuare la finitura sarà un gioco da ragazzi.

i Choose the pierced bar, add "/ SAB" at the end of the code to order the sandblasted version or add "/ Z" to order the galvanized version

Scegli la barra forata, aggiungi "/ SAB" alla fine del codice per ordinare la versione sabbiata o aggiungi "/ Z" per ordinare la versione zincata a freddo

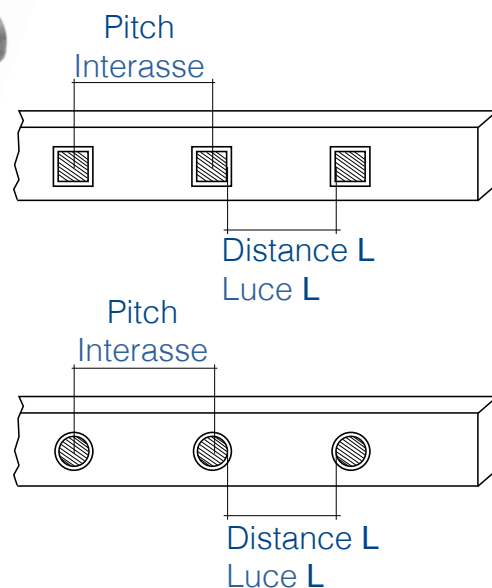

Example - Esempio

1360/6/SAB = sandblasted version
= versione sabbiata

1360/6/Z = galvanized version
= versione zincata a freddo

L 2.000 mm

| Section Sezione | Hole Foro | Section Ø Ø Sezione | Hole for Foro per | Pitch Interasse | Distance Luce | N. Holes N. Fori | Plain Liscio | Bark effect Corteccia |
|--------------------------|--------------|------------------------|----------------------|--------------------|------------------|---------------------|------------------------|--------------------------|
| | | | | | | | Art. | Art. |
| Round hole Foro tondo | | 12 mm | 12 mm | 120 mm | 108 mm | 16 | 1360/6 | - |
| | | 14 mm | 14 mm | 140 mm | 126 mm | 14 | 42/1 BEST PRICE | 606/1 |
| | | 14 mm | 14 mm | 124 mm | 110 mm | 14 | 42/A/1 | - |
| | | 16 mm | 16 mm | 150 mm | 134 mm | 13 | 42/2 | 606/2 |
| | | 16 mm | 16 mm | 126 mm | 110 mm | 14 | 42/A/2 | - |
| | | 18 mm | 18 mm | 160 mm | 142 mm | 12 | 42/3 | 606/3 |
| | | 18 mm | 18 mm | 128 mm | 110 mm | 14 | 42/A/3 | - |
| | | 20 mm | 20 mm | 170 mm | 150 mm | 11 | 42/4 | 606/4 |
| | | 20 mm | 20 mm | 130 mm | 110 mm | 14 | 42/A/4 | - |
| | | 22 mm | 22 mm | 170 mm | 148 mm | 11 | 42/5 | - |
| Oval hole Foro ovale | | 14 mm | 28 x 14 mm | 140 mm | 126 mm | 14 | 607/1 | - |
| | | 16 mm | 32 x 16 mm | 150 mm | 134 mm | 13 | 607/2 | - |
| | | 18 mm | 34 x 18 mm | 160 mm | 142 mm | 12 | 607/3 | - |
| | | 20 mm | 38 x 20 mm | 170 mm | 150 mm | 11 | 607/4 | - |



Square pierced bars - Barre forate in quadro



L 2.000 mm

| Section Sezione | Hole Foro | Section Φ Sezione Φ | Hole for Foro per | Pitch Interasse | Distance Luce | N. Holes N. Fori | Plain Liscio | Bark effect Cortecchia | Four-leaf clover Quadrifoglio | Beveled Smussato | Hammered Spigliato |
|---|--------------|--|----------------------|--------------------|------------------|---------------------|-----------------|---------------------------|----------------------------------|---------------------|-----------------------|
| Square hole on the side - Foro quadrato su lato | | 12 mm | 12 x 12 mm | 120 mm | 108 mm | 16 | Art. 1360/7 | Art. - | Art. - | Art. GD124/9 | Art. 1360/1 |
| | | 12 mm | 12 x 12 mm | 140 mm | - | 14 | - | - | 1361/5 | - | - |
| | | 14 mm | 14 x 14 mm | 140 mm | 126 mm | 14 | 42/8 | 605/1 | - | GD124/10 | 1360/2 |
| | | 14 mm | 14 x 14 mm | 124 mm | 110 mm | 14 | 42/A/5 | - | 1361/6 | - | - |
| | | 14 mm | 14 x 14 mm | 150 mm | - | 13 | - | - | 1361/7 | - | - |
| | | 15 mm | 15 x 15 mm | 160 mm | - | 12 | - | - | - | - | - |
| | | 16 mm | 16 x 16 mm | 150 mm | 134 mm | 13 | 42/9 | 605/2 | - | GD124/11 | 1360/3 |
| | | 16 mm | 16 x 16 mm | 126 mm | 110 mm | 14 | 42/A/6 | - | - | - | - |
| | | 17 mm | 17 x 17 mm | 160 mm | - | 11 | - | - | 1361/8 | - | - |
| | | 18 mm | 18 x 18 mm | 160 mm | 142 mm | 12 | 42/10 | 605/3 | - | GD124/12 | 1360/4 |
| | | 18 mm | 18 x 18 mm | 128 mm | 110 mm | 14 | 42/A/7 | - | - | - | - |
| | | 18 mm | 12 x 12 mm | 122 mm | 110 mm | 14 | 42/A/17 | - | - | - | - |
| | | 18 mm | 14 x 14 mm | 124 mm | 110 mm | 14 | 42/A/18 | - | - | - | - |
| | | 20 mm | 20 x 20 mm | 170 mm | 150 mm | 11 | 42/11 | 605/4 | - | GD124/13 | 1360/5 |
| | | 20 mm | 20 x 20 mm | 130 mm | 110 mm | 14 | 42/A/8 | - | - | - | - |
| | | 22 mm | 22 x 22 mm | 170 mm | 148 mm | 11 | 42/12 | - | - | GD124/14 | - |
| | | 25 mm | 25 x 25 mm | 180 mm | 165 mm | 10 | 42/13 | - | - | GD124/15 | - |
| 30 mm | 30 x 30 mm | 200 mm | 190 mm | 9 | 42/14 | - | - | GD124/16 | 607/4 | | |
| Square hole on the side - Foro quadrato su lato | | 12 mm | 12 x 12 mm | 140 mm | - | 14 | - | - | 1361/1 | - | - |
| | | 14 mm | 14 x 14 mm | 140 mm | - | 14 | 42/22 | 605/5 | - | - | - |
| | | 14 mm | 14 x 14 mm | 129,8 mm | 110 mm | 14 | 42/A/13 | - | - | - | - |
| | | 14 mm | 14 x 14 mm | 150 mm | - | 13 | - | - | 1361/2 | - | - |
| | | 15 mm | 15 x 15 mm | 160 mm | - | 12 | - | - | 1361/3 | - | - |
| | | 16 mm | 16 x 16 mm | 150 mm | - | 13 | 42/23 | 605/6 | - | - | - |
| | | 16 mm | 16 x 16 mm | 132,6 mm | 110 mm | 14 | 42/A/14 | - | - | - | - |
| | | 17 mm | 17 x 17 mm | 170 mm | - | 11 | - | - | 1361/4 | - | - |
| | | 18 mm | 18 x 18 mm | 160 mm | - | 12 | 42/24 | 605/7 | - | - | - |
| | | 18 mm | 18 x 18 mm | 135,5 mm | 110 mm | 14 | 42/A/15 | - | - | - | - |
| | | 18 mm | 18 x 18 mm | 125 mm | - | 15 | 42/A/15/S | - | - | - | - |
| | | 20 mm | 20 x 20 mm | 170 mm | - | 11 | 42/25 | 605/8 | - | - | - |
| | | 20 mm | 20 x 20 mm | 138,3 mm | 110 mm | 14 | 42/A/16 | - | - | - | - |
| | | 20 mm | 16 x 16 mm | 125 mm | - | 14 | 42/A/16/SP3 | - | - | - | - |
| | | Square hole on the edge - Foro quadrato su spigolo | | 14 mm | 14 x 14 mm | 140 mm | - | 14 | 42/15 | - | - |
| 14 mm | 14 x 14 mm | | | 129,8 mm | 110 mm | 14 | 42/A/9 | - | - | - | - |
| 16 mm | 16 x 16 mm | | | 150 mm | - | 13 | 42/16 | - | - | - | - |
| 16 mm | 16 x 16 mm | | | 132,6 mm | 110 mm | 14 | 42/A/10 | - | - | - | - |
| 18 mm | 18 x 18 mm | | | 160 mm | - | 12 | 42/17 | - | - | - | - |
| 18 mm | 18 x 18 mm | | | 135,5 mm | 110 mm | 14 | 42/A/11 | - | - | - | - |
| 20 mm | 20 x 20 mm | | | 170 mm | - | 11 | 42/18 | - | - | - | - |
| 20 mm | 20 x 20 mm | | | 138,3 mm | 110 mm | 14 | 42/A/12 | - | - | - | - |
| 22 mm | 22 x 22 mm | | | 170 mm | - | 11 | 42/19 | - | - | - | - |
| 25 mm | 25 x 25 mm | | | 180 mm | - | 10 | 42/20 | - | - | - | - |
| 30 mm | 30 x 30 mm | 200 mm | - | 9 | 42/21 | - | - | - | - | | |

Square pierced bars - Barre forate in quadro



L 2.000 mm

| | Section Sezione | Hole Foro | Section \varnothing Sezione \varnothing | Hole for Foro per | Pitch Interasse | Distance Luce | N. Holes N. Fori | Plain Liscio | Beveled Smussato |
|---|--------------------|--------------|--|----------------------|--------------------|------------------|---------------------|-----------------|---------------------|
| | | | | | | | | Art. | Art. |
| Oval hole on edge Foro ovale su spigolo | | | 14 mm | 18 x 15 mm | 158 mm | 140 mm | 14 | 1845/16 | - |
| | | | 16 mm | 32 x 17 mm | 182 mm | 150 mm | 13 | 1845/17 | - |
| | | | 18 mm | 34 x 19 mm | 194 mm | 160 mm | 12 | 1845/18 | - |
| | | | 20 mm | 38 x 21 mm | 208 mm | 170 mm | 11 | 1845/19 | - |
| square bar with rectangular hole barra quadrata con foro rett. | | | 14 mm | 24 x 15 mm | 164 mm | 140 mm | 14 | 1845/20 | - |
| | | | 16 mm | 30 x 17 mm | 180 mm | 150 mm | 13 | 1845/21 | - |
| | | | 18 mm | 31 x 19 mm | 191 mm | 160 mm | 12 | 1845/22 | - |
| square bar with round hole barra quadrata con foro tondo | | | 14 mm | 15 mm | 155 mm | 140 mm | 14 | 1845/24 | - |
| | | | 16 mm | 17 mm | 167 mm | 150 mm | 13 | 1845/25 | - |
| | | | 18 mm | 19 mm | 179 mm | 160 mm | 12 | 1845/26 | - |
| | | | 20 mm | 21 mm | 191 mm | 170 mm | 11 | 1845/27 | - |
| beveled bar with round hole barra smussata con foro tondo | | | 12 mm | 12 mm | 120 mm | 108 mm | 16 | - | GD124/1 |
| | | | 14 mm | 14 mm | 140 mm | 126 mm | 14 | - | GD124/2 |
| | | | 16 mm | 16 mm | 150 mm | 134 mm | 13 | - | GD124/3 |
| | | | 18 mm | 18 mm | 160 mm | 142 mm | 12 | - | GD124/4 |
| | | | 20 mm | 20 mm | 170 mm | 150 mm | 11 | - | GD124/5 |
| | | | 22 mm | 22 mm | 170 mm | 148 mm | 11 | - | GD124/6 |
| | | | 25 mm | 25 mm | 180 mm | 155 mm | 10 | - | GD124/7 |
| 30 mm | 30 mm | 200 mm | 177 mm | 9 | - | GD124/8 | | | |



Arteferro products are available in raw metal as well as sandblasted or galvanized on request.

I prodotti Arteferro sono disponibili in metallo grezzo e, su richiesta, anche sabbiati o zincati a freddo.





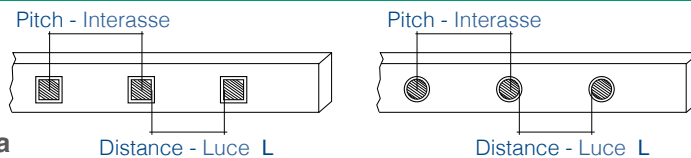

L 2.000 mm approx. - circa

| Section Sezione | Hole Foro | Hole for Foro per | Pitch Interasse | Distance Luce | Hole N. N. Fori | Plain Liscio |
|--------------------|--------------|----------------------|--------------------|------------------|--------------------|-----------------|
| | | | | | | Art. |
| 30 x 8 mm | | 12 mm | 112 mm | 100 mm | 17 | 1853/105 |
| | | | 127 mm | 115 mm | 15 | 1853/106 |
| | | | 142 mm | 130 mm | 13 | 1853/107 |
| | | 14 mm | 114 mm | 100 mm | 16 | 1853/108 |
| | | | 129 mm | 115 mm | 14 | 1853/109 |
| | | | 144 mm | 130 mm | 13 | 1853/110 |
| | | 16 mm | 116 mm | 100 mm | 16 | 1853/111 |
| | | | 131 mm | 115 mm | 14 | 1853/112 |
| | | | 146 mm | 130 mm | 13 | 1853/113 |
| 30 x 10 mm | | 12 mm | 112 mm | 100 mm | 17 | 1853/114 |
| | | | 127 mm | 115 mm | 15 | 1853/115 |
| | | | 142 mm | 130 mm | 13 | 1853/116 |
| | | 14 mm | 114 mm | 100 mm | 16 | 1853/117 |
| | | | 129 mm | 115 mm | 14 | 1853/118 |
| | | | 144 mm | 130 mm | 13 | 1853/119 |
| | | 16 mm | 116 mm | 100 mm | 16 | 1853/120 |
| | | | 131 mm | 115 mm | 14 | 1853/121 |
| | | | 146 mm | 130 mm | 13 | 1853/122 |
| 35 x 8 mm | | 12 mm | 112 mm | 100 mm | 17 | 1853/123 |
| | | | 127 mm | 115 mm | 15 | 1853/124 |
| | | | 142 mm | 130 mm | 13 | 1853/125 |
| | | 14 mm | 114 mm | 100 mm | 16 | 1853/126 |
| | | | 129 mm | 115 mm | 14 | 1853/127 |
| | | | 144 mm | 130 mm | 13 | 1853/128 |
| | | 16 mm | 116 mm | 100 mm | 16 | 1853/129 |
| | | | 131 mm | 115 mm | 14 | 1853/130 |
| | | | 146 mm | 130 mm | 13 | 1853/131 |
| 35 x 10 mm | | 12 mm | 112 mm | 100 mm | 17 | 1853/132 |
| | | | 127 mm | 115 mm | 15 | 1853/133 |
| | | | 142 mm | 130 mm | 13 | 1853/134 |
| | | 14 mm | 114 mm | 100 mm | 16 | 1853/135 |
| | | | 129 mm | 115 mm | 14 | 1853/136 |
| | | | 144 mm | 130 mm | 13 | 1853/137 |
| | | 16 mm | 116 mm | 100 mm | 16 | 1853/138 |
| | | | 131 mm | 115 mm | 14 | 1853/139 |
| | | | 146 mm | 130 mm | 13 | 1853/140 |
| 40 x 8 mm | | 12 mm | 112 mm | 100 mm | 17 | 1853/141 |
| | | | 127 mm | 115 mm | 15 | 1853/142 |
| | | | 142 mm | 130 mm | 13 | 1853/143 |
| | | 14 mm | 114 mm | 100 mm | 16 | 1853/144 |
| | | | 129 mm | 115 mm | 14 | 1853/145 |
| | | | 144 mm | 130 mm | 13 | 1853/146 |
| | | 16 mm | 116 mm | 100 mm | 16 | 1853/147 |
| | | | 131 mm | 115 mm | 14 | 1853/148 |
| | | | 146 mm | 130 mm | 13 | 1853/149 |
| 40 x 10 mm | | 12 mm | 112 mm | 100 mm | 17 | 1853/150 |
| | | | 127 mm | 115 mm | 15 | 1853/151 |
| | | | 142 mm | 130 mm | 13 | 1853/152 |
| | | 14 mm | 114 mm | 100 mm | 16 | 1853/153 |
| | | | 129 mm | 115 mm | 14 | 1853/154 |
| | | | 144 mm | 130 mm | 13 | 1853/155 |
| | | 16 mm | 116 mm | 100 mm | 16 | 1853/156 |
| | | | 131 mm | 115 mm | 14 | 1853/157 |
| | | | 146 mm | 130 mm | 13 | 1853/158 |

i

Choose the flat pierced bars, add "/ SAB" at the end of the code to order the sandblasted version or add "/ Z" to order the galvanized version

Scegli i piatti forati, aggiungi "/ SAB" alla fine del codice per ordinare la versione sabbiata o aggiungi "/ Z" per ordinare la versione zincata a freddo

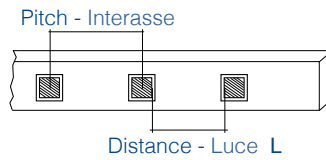

L 2.000 mm approx. - circa

| Section Sezione | Hole Foro | Hole for Foro per | Pitch Interasse | Distance Luce | Hole N. N. Fori | Plain Liscio |
|--------------------|--------------|----------------------|--------------------|------------------|--------------------|-----------------|
| | | | | | | Art. |
| 30 x 8 mm | | 12 x 12 mm | 112 mm | 100 mm | 17 | 1853/1 |
| | | | 127 mm | 115 mm | 15 | 1853/2 |
| | | | 142 mm | 130 mm | 13 | 1853/3 |
| | | 14 x 14 mm | 114 mm | 100 mm | 16 | 608/6 |
| | | | 129 mm | 115 mm | 14 | 1853/4 |
| | | | 144 mm | 130 mm | 13 | 608/5 |
| | | 16 x 16 mm | 116 mm | 100 mm | 16 | 1853/5 |
| | | | 131 mm | 115 mm | 14 | 1853/6 |
| | | | 146 mm | 130 mm | 13 | 1853/7 |
| 30 x 10 mm | | 12 x 12 mm | 112 mm | 100 mm | 17 | 1853/8 |
| | | | 127 mm | 115 mm | 15 | 1853/9 |
| | | | 142 mm | 130 mm | 13 | 1853/10 |
| | | 14 x 14 mm | 114 mm | 100 mm | 16 | 1853/11 |
| | | | 129 mm | 115 mm | 14 | 1853/12 |
| | | | 144 mm | 130 mm | 13 | 1853/13 |
| | | 16 x 16 mm | 116 mm | 100 mm | 16 | 1853/14 |
| | | | 131 mm | 115 mm | 14 | 1853/15 |
| | | | 146 mm | 130 mm | 13 | 1853/16 |
| 35 x 8 mm | | 12 x 12 mm | 112 mm | 100 mm | 17 | 1853/17 |
| | | | 127 mm | 115 mm | 15 | 1853/18 |
| | | | 142 mm | 130 mm | 13 | 1853/19 |
| | | 14 x 14 mm | 114 mm | 100 mm | 16 | 1853/20 |
| | | | 129 mm | 115 mm | 14 | 1853/21 |
| | | | 144 mm | 130 mm | 13 | 1853/22 |
| | | 16 x 16 mm | 116 mm | 100 mm | 16 | 1853/23 |
| | | | 131 mm | 115 mm | 14 | 1853/24 |
| | | | 146 mm | 130 mm | 13 | 1853/25 |
| 35 x 10 mm | | 12 x 12 mm | 112 mm | 100 mm | 17 | 1853/26 |
| | | | 127 mm | 115 mm | 15 | 1853/27 |
| | | | 142 mm | 130 mm | 13 | 1853/28 |
| | | 14 x 14 mm | 114 mm | 100 mm | 16 | 1853/29 |
| | | | 129 mm | 115 mm | 14 | 1853/30 |
| | | | 144 mm | 130 mm | 13 | 1853/31 |
| | | 16 x 16 mm | 116 mm | 100 mm | 16 | 1853/32 |
| | | | 131 mm | 115 mm | 14 | 1853/33 |
| | | | 146 mm | 130 mm | 13 | 1853/34 |
| 40 x 8 mm | | 12 x 12 mm | 112 mm | 100 mm | 17 | 1853/35 |
| | | | 127 mm | 115 mm | 15 | 1853/36 |
| | | | 142 mm | 130 mm | 13 | 1853/37 |
| | | 14 x 14 mm | 114 mm | 100 mm | 16 | 608/8 |
| | | | 129 mm | 115 mm | 14 | 1853/38 |
| | | | 144 mm | 130 mm | 13 | 608/7 |
| | | 16 x 16 mm | 116 mm | 100 mm | 16 | 1853/39 |
| | | | 131 mm | 115 mm | 14 | 1853/40 |
| | | | 146 mm | 130 mm | 13 | 1853/41 |
| 40 x 10 mm | | 12 x 12 mm | 112 mm | 100 mm | 17 | 1853/42 |
| | | | 127 mm | 115 mm | 15 | 1853/43 |
| | | | 142 mm | 130 mm | 13 | 1853/44 |
| | | 14 x 14 mm | 114 mm | 100 mm | 16 | 1853/45 |
| | | | 129 mm | 115 mm | 14 | 1853/46 |
| | | | 144 mm | 130 mm | 13 | 1853/47 |
| | | 16 x 16 mm | 116 mm | 100 mm | 16 | 1853/48 |
| | | | 131 mm | 115 mm | 14 | 1853/49 |
| | | | 146 mm | 130 mm | 13 | 1853/50 |



i The punched plates can also be made to measure up to 6 metres.

I piatti forati sono realizzabili anche su misura fino a 6 mt.

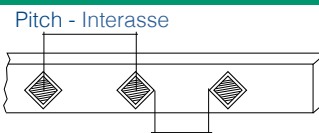

L 2.000 mm approx. - circa

Distance - Luce L

| Section Sezione | Hole Foro | Hole for Foro per | Pitch Interasse | Distance Luce | Hole N. N. Fori | Plain Liscio |
|--------------------|--------------|----------------------|--------------------|------------------|--------------------|-----------------|
| | | | | | | Art. |
| 30 x 8 mm | | 12 x 12 mm | 117 mm | 100 mm | 16 | 1853/51 |
| | | | 132 mm | 115 mm | 14 | 1853/52 |
| | | | 147 mm | 130 mm | 13 | 1853/53 |
| | | 14 x 14 mm | 119,8 mm | 100 mm | 16 | 1853/54 |
| | | | 134,8 mm | 115 mm | 14 | 1853/55 |
| | | | 149,8 mm | 130 mm | 12 | 1853/56 |
| | | 16 x 16 mm | 122,6 mm | 100 mm | 16 | 1853/57 |
| | | | 137,6 mm | 115 mm | 14 | 1853/58 |
| | | | 152,6 mm | 130 mm | 12 | 1853/59 |
| 30 x 10 mm | | 12 x 12 mm | 117 mm | 100 mm | 16 | 1853/60 |
| | | | 132 mm | 115 mm | 14 | 1853/61 |
| | | | 147 mm | 130 mm | 13 | 1853/62 |
| | | 14 x 14 mm | 119,8 mm | 100 mm | 16 | 1853/63 |
| | | | 134,8 mm | 115 mm | 14 | 1853/64 |
| | | | 149,8 mm | 130 mm | 12 | 1853/65 |
| | | 16 x 16 mm | 122,6 mm | 100 mm | 16 | 1853/66 |
| | | | 137,6 mm | 115 mm | 14 | 1853/67 |
| | | | 152,6 mm | 130 mm | 12 | 1853/68 |
| 35 x 8 mm | | 12 x 12 mm | 117 mm | 100 mm | 16 | 1853/69 |
| | | | 132 mm | 115 mm | 14 | 1853/70 |
| | | | 147 mm | 130 mm | 13 | 1853/71 |
| | | 14 x 14 mm | 119,8 mm | 100 mm | 16 | 1853/72 |
| | | | 134,8 mm | 115 mm | 14 | 1853/73 |
| | | | 149,8 mm | 130 mm | 12 | 1853/74 |
| | | 16 x 16 mm | 122,6 mm | 100 mm | 16 | 1853/75 |
| | | | 137,6 mm | 115 mm | 14 | 1853/76 |
| | | | 152,6 mm | 130 mm | 12 | 1853/77 |
| 35 x 10 mm | | 12 x 12 mm | 117 mm | 100 mm | 16 | 1853/78 |
| | | | 132 mm | 115 mm | 14 | 1853/79 |
| | | | 147 mm | 130 mm | 13 | 1853/80 |
| | | 14 x 14 mm | 119,8 mm | 100 mm | 16 | 1853/81 |
| | | | 134,8 mm | 115 mm | 14 | 1853/82 |
| | | | 149,8 mm | 130 mm | 12 | 1853/83 |
| | | 16 x 16 mm | 122,6 mm | 100 mm | 16 | 1853/84 |
| | | | 137,6 mm | 115 mm | 14 | 1853/85 |
| | | | 152,6 mm | 130 mm | 12 | 1853/86 |
| 40 x 8 mm | | 12 x 12 mm | 117 mm | 100 mm | 16 | 1853/87 |
| | | | 132 mm | 115 mm | 14 | 1853/88 |
| | | | 147 mm | 130 mm | 13 | 1853/89 |
| | | 14 x 14 mm | 119,8 mm | 100 mm | 16 | 1853/90 |
| | | | 134,8 mm | 115 mm | 14 | 1853/91 |
| | | | 149,8 mm | 130 mm | 12 | 1853/92 |
| | | 16 x 16 mm | 122,6 mm | 100 mm | 16 | 1853/93 |
| | | | 137,6 mm | 115 mm | 14 | 1853/94 |
| | | | 152,6 mm | 130 mm | 12 | 1853/95 |
| 40 x 10 mm | | 12 x 12 mm | 117 mm | 100 mm | 16 | 1853/96 |
| | | | 132 mm | 115 mm | 14 | 1853/97 |
| | | | 147 mm | 130 mm | 13 | 1853/98 |
| | | 14 x 14 mm | 119,8 mm | 100 mm | 16 | 1853/99 |
| | | | 134,8 mm | 115 mm | 14 | 1853/100 |
| | | | 149,8 mm | 130 mm | 12 | 1853/101 |
| | | 16 x 16 mm | 122,6 mm | 100 mm | 16 | 1853/102 |
| | | | 137,6 mm | 115 mm | 14 | 1853/103 |
| | | | 152,6 mm | 130 mm | 12 | 1853/104 |



The punched bars can also be made to measure up to 6 metres.

I piatti forati sono realizzabili anche su misura fino a 6 mt.

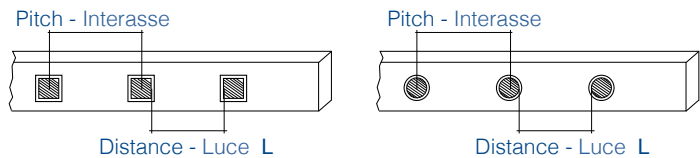

L 2.000 mm approx. - circa

| Section Sezione | Hole Foro | Hole for Foro per | Pitch Interasse | Distance Luce | Hole N. N. Fori | Hammered on 2 corners Spigolato su 2 angoli | Hammered on 4 edges and 2 sides Battuto 4 spigoli e 2 lati |
|--------------------|-----------------------------|----------------------|--------------------|------------------|--------------------|--|---|
| | | | | | | Art. | Art. |
| 30 x 8 mm | [Diagram of square holes] | 12 x 12 mm | 112 mm | 100 mm | 17 | 1853/159 | 1853/195 |
| | | | 127 mm | 115 mm | 15 | 1853/160 | 1853/196 |
| | | | 142 mm | 130 mm | 13 | 1853/161 | 1853/197 |
| | | 14 x 14 mm | 114 mm | 100 mm | 16 | 1853/162 | 1853/198 |
| | | | 129 mm | 115 mm | 14 | 1853/163 | 1853/199 |
| | | | 147 mm | 130 mm | 13 | 1853/164 | 609/2 |
| | | 16 x 16 mm | 116 mm | 100 mm | 16 | 1853/165 | 1853/201 |
| | | | 131 mm | 115 mm | 14 | 1853/166 | 1853/202 |
| | | | 146 mm | 130 mm | 13 | 1853/167 | 1853/203 |
| 40 x 8 mm | [Diagram of square holes] | 12 x 12 mm | 112 mm | 100 mm | 17 | 1853/168 | 1853/204 |
| | | | 127 mm | 115 mm | 15 | 1853/169 | 1853/205 |
| | | | 142 mm | 130 mm | 13 | 1853/170 | 1853/206 |
| | | 14 x 14 mm | 114 mm | 100 mm | 16 | 1853/171 | 1853/207 |
| | | | 129 mm | 115 mm | 14 | 1853/172 | 1853/208 |
| | | | 147 mm | 130 mm | 13 | 1853/173 | 1853/209 |
| | | 16 x 16 mm | 116 mm | 100 mm | 16 | 1853/174 | 1853/210 |
| | | | 131 mm | 115 mm | 14 | 1853/175 | 1853/211 |
| | | | 146 mm | 130 mm | 13 | 1853/176 | 1853/212 |
| 30 x 8 mm | [Diagram of circular holes] | 12 mm | 112 mm | 100 mm | 17 | 1853/177 | 1853/213 |
| | | | 127 mm | 115 mm | 15 | 1853/178 | 1853/214 |
| | | | 142 mm | 130 mm | 13 | 1853/179 | 1853/215 |
| | | 14 mm | 114 mm | 100 mm | 16 | 1853/180 | 1853/216 |
| | | | 129 mm | 115 mm | 14 | 1853/181 | 1853/217 |
| | | | 147 mm | 130 mm | 13 | 1853/182 | 1853/218 |
| | | 16 mm | 116 mm | 100 mm | 16 | 1853/183 | 1853/219 |
| | | | 131 mm | 115 mm | 14 | 1853/184 | 1853/220 |
| | | | 146 mm | 130 mm | 13 | 1853/185 | 1853/221 |
| 40 x 8 mm | [Diagram of circular holes] | 12 mm | 112 mm | 100 mm | 17 | 1853/186 | 1853/222 |
| | | | 127 mm | 115 mm | 15 | 1853/187 | 1853/223 |
| | | | 142 mm | 130 mm | 13 | 1853/188 | 1853/224 |
| | | 14 mm | 114 mm | 100 mm | 16 | 1853/189 | 1853/225 |
| | | | 129 mm | 115 mm | 14 | 1853/190 | 1853/226 |
| | | | 147 mm | 130 mm | 13 | 1853/191 | 1853/227 |
| | | 16 mm | 116 mm | 100 mm | 16 | 1853/192 | 1853/228 |
| | | | 131 mm | 115 mm | 14 | 1853/193 | 1853/229 |
| | | | 146 mm | 130 mm | 13 | 1853/194 | 1853/230 |



HOT PIERCED - FORATI A CALDO

L 2.000 mm approx. - circa

| Section  Sezione  | Hole Foro | Hole for Foro per | Pitch Interasse | Distance Luce | Hole N. N. Fori | Plain Liscio |
|--|---|----------------------|--------------------|------------------|--------------------|-----------------|
| |  | | | | | Art. |
| 30 x 15 mm | | 18 x 18 mm | 140 mm | 122 mm | 13 | 1360/10 |
| 30 x 20 mm | | 18 x 18 mm | 140 mm | 122 mm | 13 | 1360/11 |



Choose the flat pierced bars, add "/ SAB" at the end of the code to order the sandblasted version or add "/ Z" to order the galvanized version

Scegli i piatti forati, aggiungi "/ SAB" alla fine del codice per ordinare la versione sabbiata o aggiungi "/ Z" per ordinare la versione zincata a freddo

HOT PIERCED - FORATI A CALDO

L 2.000 mm approx. - circa

| Section  Sezione  | Hole Foro | Hole for Foro per | Pitch Interasse | Distance Luce | Hole N. N. Fori | Plain Liscio |
|--|---|----------------------|--------------------|------------------|--------------------|-----------------|
| |  | | | | | Art. |
| 30 x 15 mm | | 20 mm | 140 mm | 120 mm | 14 | 1360/8 |
| 30 x 20 mm | | 20 mm | 140 mm | 120 mm | 14 | 1360/9 |





51.000 km

of pierced bars have been manufactured by our factories to date. The circumference of the Earth is "only" 40,075 km

di barre forate sono state prodotte fino ad oggi nei nostri stabilimenti. La circonferenza della Terra è di "soli" 40.075 km

COLD PUNCHED - FORATI A FREDDO

| Section  Sezione  | Hole Foro | Hole for Foro per | Pitch Interasse | Distance Luce | Hole N. N. Fori | Plain Liscio | Length Lunghezza |
|--|---|----------------------|--------------------|------------------|--------------------|-----------------|---------------------|
| |  | | | | | Art. | |
| 40 x 8 mm | | 14 x 14 mm | 140 | 120 mm | 14 | 1360/12 | 2070 mm |
| 40 x 8 mm | | 16 x 16 mm | 143 | 120 mm | 14 | 1360/13 | 2110 mm |

Handrail - Corrimano
Art.114/10/S

| Section - Sezione | For hole - Per Foro | Pitch - Interasse | Holes Nr. - N. Fori | Art. |
|-------------------|---------------------|-------------------|---------------------|---------|
| 30 x 20 x 2 mm | Ø 12 mm | 125 mm | 23 | 1852/42 |
| 30 x 20 x 2 mm | Ø 14 mm | 125 mm | 23 | 1852/49 |
| 30 x 20 x 2 mm | □ 12 mm | 125 mm | 23 | 1852/44 |
| 30 x 20 x 2 mm | □ 14 mm | 125 mm | 23 | 1852/50 |
| 40 x 20 x 2 mm | Ø 12 mm | 125 mm | 23 | 1852/57 |
| 40 x 20 x 2 mm | Ø 14 mm | 125 mm | 23 | 1852/58 |
| 40 x 20 x 2 mm | Ø 16 mm | 125 mm | 23 | 1852/59 |
| 40 x 20 x 2 mm | □ 12 mm | 125 mm | 23 | 1852/60 |
| 40 x 20 x 2 mm | □ 14 mm | 125 mm | 23 | 1852/61 |
| 40 x 20 x 2 mm | □ 16 mm | 125 mm | 23 | 1852/62 |
| 50 x 25 x 2 mm | Ø 12 mm | 125 mm | 23 | 1852/81 |
| 50 x 25 x 2 mm | Ø 14 mm | 125 mm | 23 | 1852/82 |
| 50 x 25 x 2 mm | Ø 16 mm | 125 mm | 23 | 1852/83 |
| 50 x 25 x 2 mm | □ 12 mm | 125 mm | 23 | 1852/84 |
| 50 x 25 x 2 mm | □ 14 mm | 125 mm | 23 | 1852/85 |
| 50 x 25 x 2 mm | □ 16 mm | 125 mm | 23 | 1852/86 |

Punched tubes - Tubi forati

L 3.000 mm approx. - circa



NEW Plain - Liscio
Plain tube with through holes
Tubo liscio con fori passanti

| Section - Sezione | For hole - Per Foro | Pitch - Interasse | Holes Nr. - N. Fori | Art. |
|-------------------|---------------------|-------------------|---------------------|---------|
| 30 x 20 x 2 mm | Ø 12 mm | 125 mm | 23 | 1852/41 |
| 30 x 20 x 2 mm | Ø 14 mm | 125 mm | 23 | 1852/51 |
| 30 x 20 x 2 mm | □ 12 mm | 125 mm | 23 | 1852/43 |
| 30 x 20 x 2 mm | □ 14 mm | 125 mm | 23 | 1852/52 |
| 40 x 20 x 2 mm | Ø 12 mm | 125 mm | 23 | 1852/63 |
| 40 x 20 x 2 mm | Ø 14 mm | 125 mm | 23 | 1852/64 |
| 40 x 20 x 2 mm | Ø 16 mm | 125 mm | 23 | 1852/65 |
| 40 x 20 x 2 mm | □ 12 mm | 125 mm | 23 | 1852/66 |
| 40 x 20 x 2 mm | □ 14 mm | 125 mm | 23 | 1852/67 |
| 40 x 20 x 2 mm | □ 16 mm | 125 mm | 23 | 1852/68 |
| 50 x 25 x 2 mm | Ø 12 mm | 125 mm | 23 | 1852/87 |
| 50 x 25 x 2 mm | Ø 14 mm | 125 mm | 23 | 1852/88 |
| 50 x 25 x 2 mm | Ø 16 mm | 125 mm | 23 | 1852/89 |
| 50 x 25 x 2 mm | □ 12 mm | 125 mm | 23 | 1852/90 |
| 50 x 25 x 2 mm | □ 14 mm | 125 mm | 23 | 1852/91 |
| 50 x 25 x 2 mm | □ 16 mm | 125 mm | 23 | 1852/92 |

L 3.000 mm approx. - circa



NEW Plain - Liscio
Plain tube with blind holes
Tubo liscio con fori ciechi

| Section - Sezione | For hole - Per Foro | Pitch - Interasse | Holes Nr. - N. Fori | Art. |
|-------------------|---------------------|-------------------|---------------------|---------|
| 30 x 20 x 2 mm | Ø 12 mm | 125 mm | 23 | 1852/46 |
| 30 x 20 x 2 mm | Ø 14 mm | 125 mm | 23 | 1852/53 |
| 30 x 20 x 2 mm | □ 12 mm | 125 mm | 23 | 1852/48 |
| 30 x 20 x 2 mm | □ 14 mm | 125 mm | 23 | 1852/54 |
| 40 x 20 x 2 mm | Ø 12 mm | 125 mm | 23 | 1852/69 |
| 40 x 20 x 2 mm | Ø 14 mm | 125 mm | 23 | 1852/70 |
| 40 x 20 x 2 mm | Ø 16 mm | 125 mm | 23 | 1852/71 |
| 40 x 20 x 2 mm | □ 12 mm | 125 mm | 23 | 1852/72 |
| 40 x 20 x 2 mm | □ 14 mm | 125 mm | 23 | 1852/73 |
| 40 x 20 x 2 mm | □ 16 mm | 125 mm | 23 | 1852/74 |
| 50 x 25 x 2 mm | Ø 12 mm | 125 mm | 23 | 1852/93 |
| 50 x 25 x 2 mm | Ø 14 mm | 125 mm | 23 | 1852/94 |
| 50 x 25 x 2 mm | Ø 16 mm | 125 mm | 23 | 1852/95 |
| 50 x 25 x 2 mm | □ 12 mm | 125 mm | 23 | 1852/96 |
| 50 x 25 x 2 mm | □ 14 mm | 125 mm | 23 | 1852/97 |
| 50 x 25 x 2 mm | □ 16 mm | 125 mm | 23 | 1852/98 |

L 3.000 mm approx. - circa



NEW Hammered on the edges - Battuto sugli spigoli
Hammered tube with through holes
Long hammering
Tubo spigolato con fori passanti
Spigolatura allungata

| Section - Sezione | For hole - Per Foro | Pitch - Interasse | Holes Nr. - N. Fori | Art. |
|-------------------|---------------------|-------------------|---------------------|----------|
| 30 x 20 x 2 mm | Ø 12 mm | 125 mm | 23 | 1852/45 |
| 30 x 20 x 2 mm | Ø 14 mm | 125 mm | 23 | 1852/55 |
| 30 x 20 x 2 mm | □ 12 mm | 125 mm | 23 | 1852/47 |
| 30 x 20 x 2 mm | □ 14 mm | 125 mm | 23 | 1852/56 |
| 40 x 20 x 2 mm | Ø 12 mm | 125 mm | 23 | 1852/75 |
| 40 x 20 x 2 mm | Ø 14 mm | 125 mm | 23 | 1852/76 |
| 40 x 20 x 2 mm | Ø 16 mm | 125 mm | 23 | 1852/77 |
| 40 x 20 x 2 mm | □ 12 mm | 125 mm | 23 | 1852/78 |
| 40 x 20 x 2 mm | □ 14 mm | 125 mm | 23 | 1852/79 |
| 40 x 20 x 2 mm | □ 16 mm | 125 mm | 23 | 1852/80 |
| 50 x 25 x 2 mm | Ø 12 mm | 125 mm | 23 | 1852/99 |
| 50 x 25 x 2 mm | Ø 14 mm | 125 mm | 23 | 1852/100 |
| 50 x 25 x 2 mm | Ø 16 mm | 125 mm | 23 | 1852/101 |
| 50 x 25 x 2 mm | □ 12 mm | 125 mm | 23 | 1852/102 |
| 50 x 25 x 2 mm | □ 14 mm | 125 mm | 23 | 1852/103 |
| 50 x 25 x 2 mm | □ 16 mm | 125 mm | 23 | 1852/104 |

L 3.000 mm approx. - circa



NEW Hammered on the edges - Battuto sugli spigoli
Hammered tube with blind holes Long hammering
Tubo spigolato con fori ciechi Spigolatura allungata

● Holes for - Fori per Ø 30 mm



Round hole
Foro tondo
Art. 200/3
□ 30 x 30 mm
H 1200 mm

Round hole
Foro tondo
Art. 200/12
□ 30 x 30 mm
H 1200 mm

Round hole
Foro tondo
Art. 200/14
□ 30 x 30 mm
H 1200 mm

Round hole
Foro tondo
Art. 200/16
□ 30 x 30 mm
H 1200 mm

Round hole
Foro tondo
Art. 200/9
□ 30 x 30 mm
H 1100 mm

Round hole
Foro tondo
Art. 200/5
Ø 30 mm
H 1200 mm

Round hole
Foro tondo
Art. 200/18
Ø 30 mm
H 1200 mm



Choose the item, add **"/ SAB"** at the end of the code to order the sandblasted version or add **"/ Z"** to order the galvanized version

Scegli l'articolo aggiungi **"/ SAB"** alla fine del codice per ordinare la versione sabbata o aggiungi **"/ Z"** per ordinare la versione zincata a freddo



- upper hole for Ø 25 mm
foro superiore per Ø 25 mm
- lower holes for Ø 22 mm
fori inferiori per Ø 22 mm

- upper hole for Ø 30 mm
foro superiore per Ø 30 mm
- lower holes for Ø 25 mm
fori inferiori per Ø 25 mm

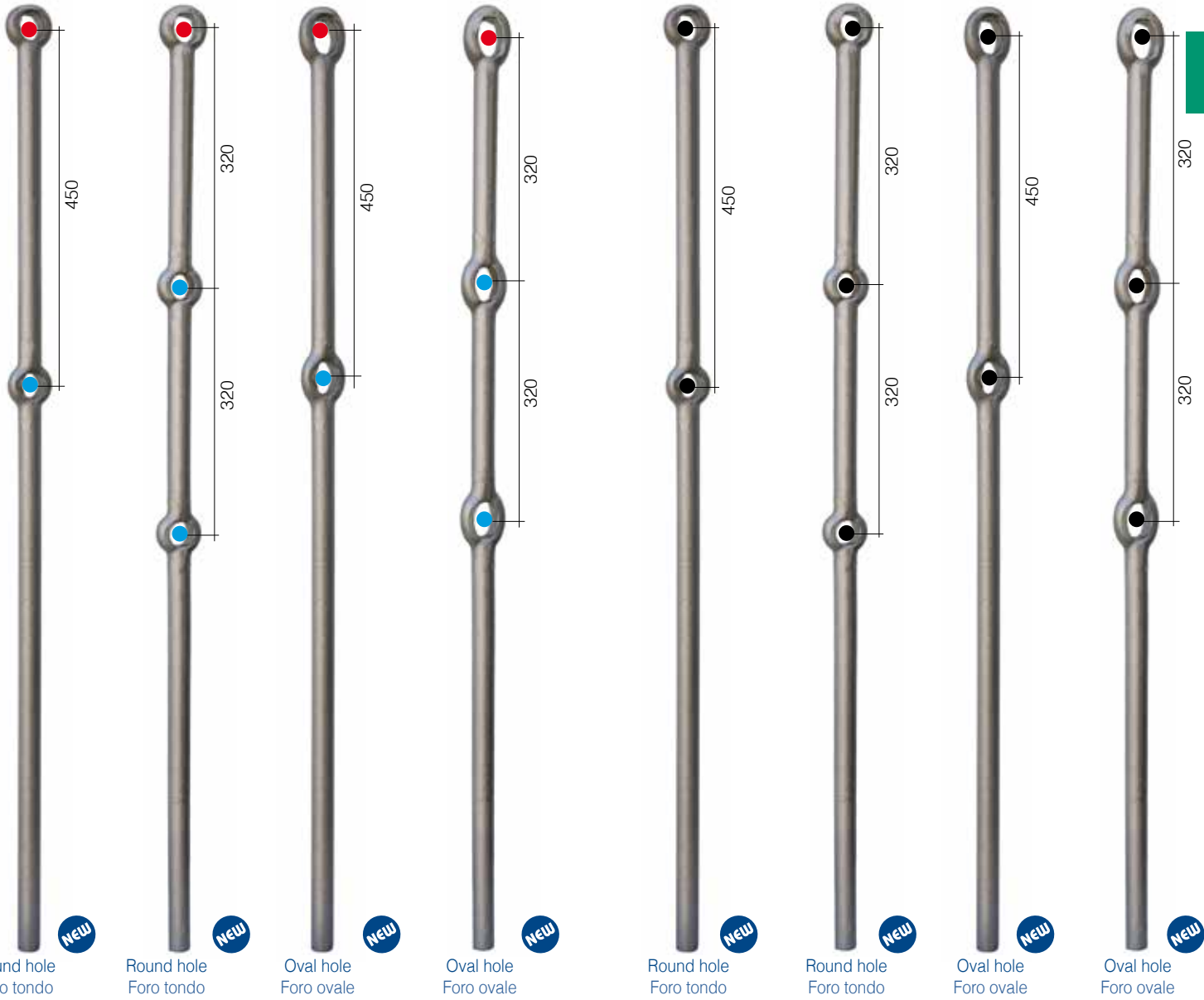

| | | | | | | | |
|--------------------------|--------------------------|-------------------------|-------------------------|--------------------------|--------------------------|-------------------------|-------------------------|
| Round hole Foro tondo | Round hole Foro tondo | Oval hole Foro ovale | Oval hole Foro ovale | Round hole Foro tondo | Round hole Foro tondo | Oval hole Foro ovale | Oval hole Foro ovale |
| Art. 200/5/S28 | Art. 200/18/S12 | Art. 200/5/S44 | Art. 200/18/S14 | Art. 200/5/S45 | Art. 200/18/S13 | Art. 200/5/S46 | Art. 200/18/S24 |
| Ø 25 mm | Ø 25 mm | Ø 25 mm | Ø 25 mm | Ø 30 mm | Ø 30 mm | Ø 30 mm | Ø 30 mm |
| H 1200 mm | H 1200 mm | H 1200 mm | H 1200 mm | H 1200 mm | H 1200 mm | H 1200 mm | H 1200 mm |

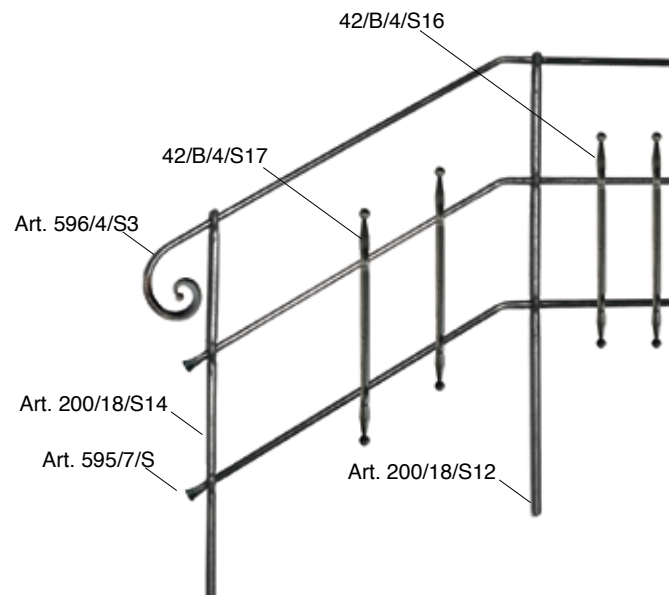
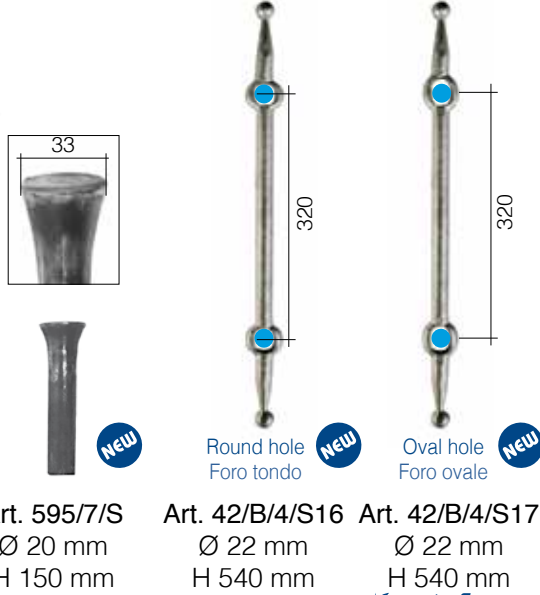
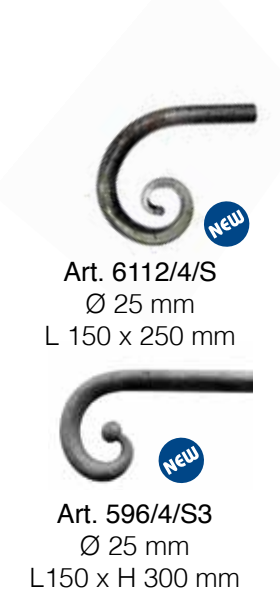

| | | | | |
|----------------|------------------|--------------|-----------------|-----------------|
| Art. 6112/4/S | Art. 596/4/S3 | Art. 595/7/S | Art. 42/B/4/S16 | Art. 42/B/4/S17 |
| Ø 25 mm | Ø 25 mm | Ø 20 mm | Ø 22 mm | Ø 22 mm |
| L 150 x 250 mm | L 150 x H 300 mm | H 150 mm | H 540 mm | H 540 mm |

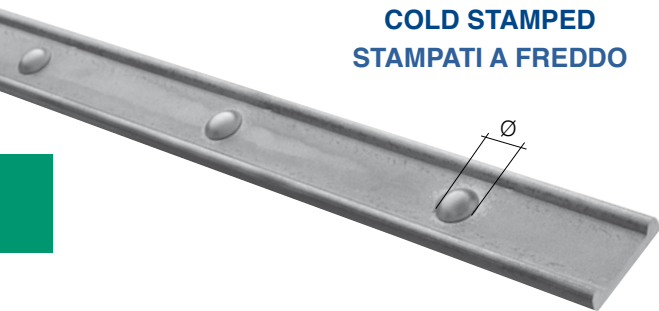
**COLD STAMPED
STAMPATI A FREDDO****HOT ROLLED PROFILES
PROFILI LISCI LAMINATI A CALDO**

| Section - Sezione | Art. | Length - Lunghezza |
|-------------------|-----------|--------------------|
| | 25 x 8 mm | 158/49 |
| | | 158/52 |
| | 30 x 8 mm | 158/50 |
| | | 158/53 |
| | 40 x 8 mm | 158/51 |
| | | 158/54 |

L 2.000 mm approx. - circa

| Section / Sezione | Rivet Ribattino | Pitch - Interasse 112 mm | Pitch - Interasse 122 mm | Pitch - Interasse 127 mm | Pitch - Interasse 132 mm |
|--------------------|-----------------|--------------------------|--------------------------|--------------------------|--------------------------|
| | | Art. | Art. | Art. | Art. |
| 30 x 8 mm | Ø 11 mm | 1852/1 | 1852/2 | 1852/3 | 1852/4 |
| 40 x 8 mm | Ø 16 mm | 1852/5 | 1852/6 | 1852/7 | 1852/8 |

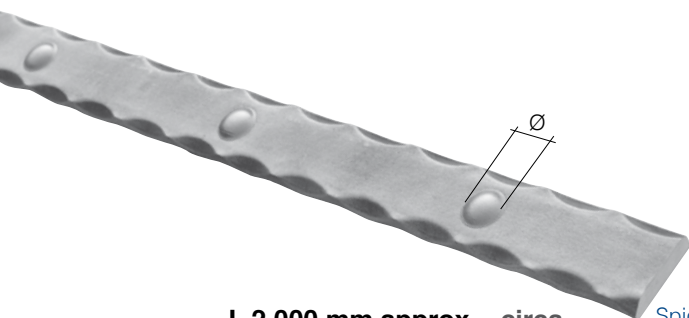
**L 2.000 mm approx. - circa**

Spigolato su 2 angoli - Hammered on 2 corners

| Section / Sezione | Rivet Ribattino | Pitch - Interasse 112 mm | Pitch - Interasse 122 mm | Pitch - Interasse 127 mm | Pitch - Interasse 132 mm |
|--------------------|-----------------|--------------------------|--------------------------|--------------------------|--------------------------|
| | | Art. | Art. | Art. | Art. |
| 25 x 6 mm | Ø 16 mm | 1852/9 | 1852/10 | 1852/11 | 1852/12 |
| 25 x 8 mm | Ø 16 mm | 1852/13 | 1852/14 | 1852/15 | 1852/16 |
| 30 x 6 mm | Ø 16 mm | 1852/17 | 1852/18 | 1852/19 | 1852/20 |
| 30 x 8 mm | Ø 16 mm | 1852/21 | 1852/22 | 1852/23 | 1852/24 |

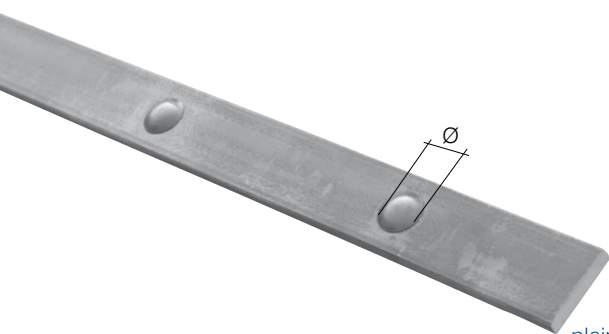

plain - liscio

L 2.000 mm approx. - circa

| Section / Sezione | Rivet Ribattino | Pitch - Interasse 112 mm | Pitch - Interasse 122 mm | Pitch - Interasse 127 mm | Pitch - Interasse 132 mm |
|--------------------|-----------------|--------------------------|--------------------------|--------------------------|--------------------------|
| | | Art. | Art. | Art. | Art. |
| 25 x 6 mm | Ø 16 mm | 1852/25 | 1852/26 | 1852/27 | 1852/28 |
| 25 x 8 mm | Ø 16 mm | 1852/29 | 1852/30 | 1852/31 | 1852/32 |
| 30 x 6 mm | Ø 16 mm | 1852/33 | 1852/34 | 1852/35 | 1852/36 |
| 30 x 8 mm | Ø 16 mm | 1852/37 | 1852/38 | 1852/39 | 1852/40 |



Art. 118/2
for-per 614/5 - 614/6
Ø 14 x 14 mm
L 3000 mm

**HOT STAMPED
STAMPATI A CALDO**



Art. 614/4 **BEST PRICE**
Ø 14 x 14 mm
pitch-interasse 125 mm
L 2.000 mm
n. 15 bushes-borchie



plain - liscio



Art. 614/5
Ø 14 x 14 mm
pitch-interasse 125 mm
L 2.000 mm
n. 15 bushes-borchie



hammered - spigolato



hammered - spigolato



Pag. 20

In section 1
Long bars you'll
find the profiles
to match
Nel capitolo 1
Barre lunghe
troverai i profili
da abbinare

Art. 614/6
Ø 14 x 14 mm
pitch-interasse 125 mm
L 2.000 mm
n. 15 bushes-borchie

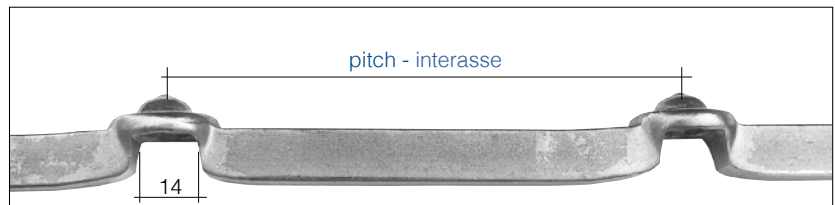



Art. 40/B/10
 ▣ 20 x 6 mm

Art. 40/B/10/S1
 ▣ 25 x 6 mm

L 2.000 mm - pitch - interasse 180 mm
 holes - fori Ø 8,5 mm

pitch - interasse

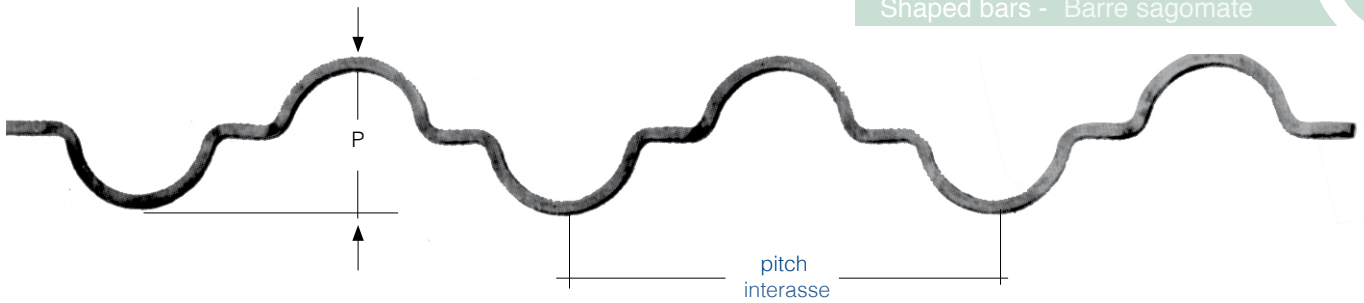

|  Plain Liscio | Section - Sezione | Art. | Pitch - Interasse | P | Length - Lunghezza |
|--|-------------------|--------|-------------------|--------|--------------------|
| | □ 8 x 8 mm | 38/1 | 240 mm | 84 mm | 1600 mm |
| | ▤ 12 x 6 mm | 38/2 | 240 mm | 80 mm | 1600 mm |
| | □ 10 x 10 mm | 38/3 | 250 mm | 95 mm | 1600 mm |
| | □ 12 x 12 mm | 38/4 | 260 mm | 100 mm | 1600 mm |
| | ∅ 10 mm | 1846/1 | 180 mm | 100 mm | 2000 mm |

| | | | | | |
|--|--------------|-------|--------|--------|---------|
|  Hammered Spigolato | □ 12 x 12 mm | 621/1 | 260 mm | 100 mm | 1600 mm |
|--|--------------|-------|--------|--------|---------|

| | | | | | |
|---|--------------|--------|--------|--------|---------|
|  Bark effect Corteccia | □ 12 x 12 mm | 1358/1 | 260 mm | 100 mm | 1600 mm |
|---|--------------|--------|--------|--------|---------|

| | | | | | |
|---|--------------|--------|--------|--------|---------|
|  Diamond Diamantato | □ 12 x 12 mm | 1358/2 | 260 mm | 100 mm | 1600 mm |
|---|--------------|--------|--------|--------|---------|

| | | | | | |
|--|--------------|-------|--------|--------|---------|
|  Grooved Rigato | □ 12 x 12 mm | 620/1 | 260 mm | 100 mm | 1600 mm |
|--|--------------|-------|--------|--------|---------|

L 6000 mm - pitch - interasse 178 mm



Stamped on the corners
Stampate sullo spigolo

Art. 40/1
□ 14 x 14 mm

Art. 40/2
□ 12 x 12 mm

Art. 40/3
□ 10 x 10 mm

Art. 40/4
□ 8 x 8 mm

Art. 40/5
∅ 12 mm



Art. 40/A/1
□ 12 x 12 mm

L 6000 mm - pitch - interasse 140 mm



Stamped on the side
Stampate sul lato

Art. 40/A/1/S
□ 14 x 14 mm

L 6000 mm - pitch - interasse 140 mm



Stamped on the side
Stampate sul lato



Art. 40/A/2
□ 12 x 12 mm

L 6000 mm - pitch - interasse 300 mm



Stamped on the side
Stampate sul lato



Art. 40/A/3
□ 12 x 12 mm

L 6000 mm - pitch - interasse 200 mm



Stamped on the side
Stampate sul lato



IAM Design General Catalogue Vol.18
updated contents, renewed graphics
and new in-depth information about the entire range
of IAM Design products.

Catalogo generale IAM Design Vol.18
contenuti aggiornati, grafica rinnovata e nuovi
approfondimenti su tutta la linea di prodotti IAM Design.



**Download the digital version from - Scarica la versione digitale da
www.iamdesign.com/download**

IAM Design - examples of applications, this is the catalogue of application solutions dedicated to architects and designers. As always, the experts at IAM Design are available to provide a customized consultancy service, so they can collaborate step by step with all of the professional involved in implementing your projects.

IAM Design - esempi di applicazioni è il catalogo di soluzioni applicative dedicato ad architetti e progettisti. Come sempre, gli esperti di IAM Design sono a disposizione per fornire un servizio di consulenza su misura al fine di collaborare passo passo con ogni professionista alla realizzazione dei suoi progetti.

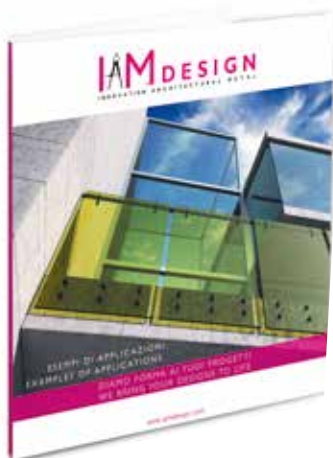

**EXAMPLES
OF APPLICATIONS**

**ESEMPI
DI APPLICAZIONI**

www.iamdesign.com



Arteferro overthrow are decorative elements that can be used as the crowning points of a fence, a gate, a door or a window. From the simplest to the most elaborate, every Arteferro overthrow is ready for installation and is an ideal solution for combining fast installation and aesthetic results.

Le cimase Arteferro sono elementi decorativi che possono fare da coronamento per una recinzione, un cancello, un portone o una finestra. Dalla più semplice alla più elaborata, ogni cimasa Arteferro è pronta per l'installazione e rappresenta la soluzione ideale per combinare rapidità di posa e risultato estetico.

OVERTHROWS

CIMASE



Rounded cut ends
Estremità tranciate a rondella

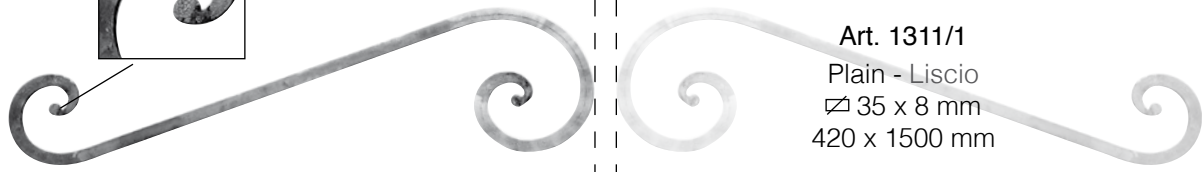

Art. 1311/1
Plain - Liscio
∅ 35 x 8 mm
420 x 1500 mm



Art. 1311/2
Plain - Liscio
∅ 35 x 8 mm
420 x 1500 mm

Rounded cut ends
Estremità tranciate a rondella

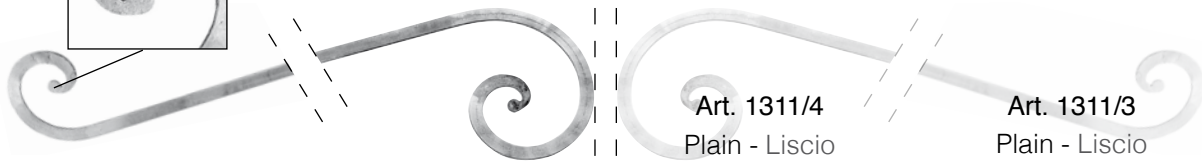

Art. 1311/4
Plain - Liscio
∅ 35 x 8 mm
420 x 1000 mm

Art. 1311/3
Plain - Liscio
∅ 35 x 8 mm
240 x 1000 mm

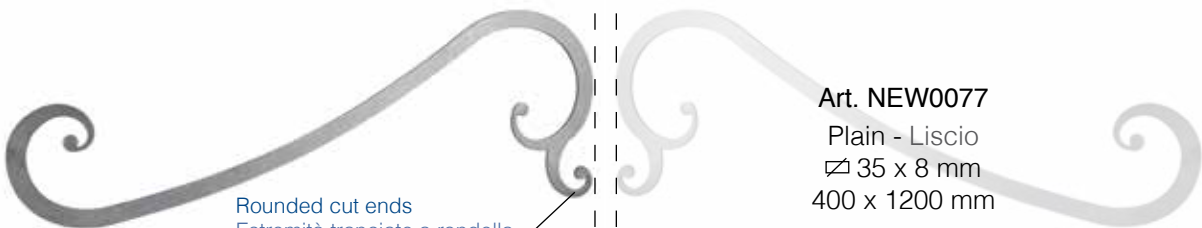

Rounded cut ends
Estremità tranciate a rondella



Art. NEW0077
Plain - Liscio
∅ 35 x 8 mm
400 x 1200 mm



Send us
your own designs
for your overthrows,
and we'll do the rest
for you!

Inviaci il disegno
della tua cimasa,
la faremo apposta
per te!



Art. NEW0078
Plain - Liscio
∅ 35 x 8 mm
570 x 2000 mm

Cut ends with dovetail
Estremità tranciate
a coda di rondine

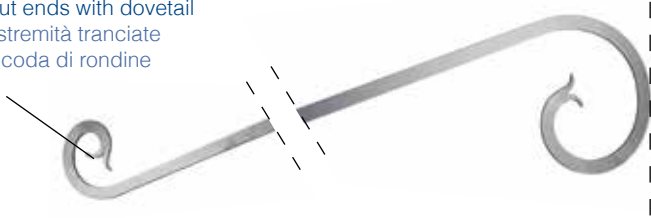

Art. NEW0080
Plain - Liscio
∅ 35 x 8 mm
400 x 1300 mm

Art. NEW0079
Plain - Liscio
∅ 35 x 8 mm
250 x 700 mm

X
↓
↑

Rounded cut ends
Estremità tranciate a rondella



Art. NEW0081
Plain - Liscio
∅ 35 x 8 mm
400 x 2100 mm
X 130 mm

Art. NEW0082
Plain - Liscio
∅ 35 x 8 mm
400 x 2000 mm

A

L 2000 mm
H 500 mm

B

L 1200 mm
H 250 mm



plain
liscio



A

Art. 1827/5
∅ 30 x 8 mm
Art. 1827/6
∅ 40 x 8 mm

B

Art. 1827/11
∅ 30 x 8 mm
Art. 1827/12
∅ 40 x 8 mm

hammered on 4 corners
spigolato 4 angoli



A

Art. 1827/1
∅ 30 x 8 mm
Art. 1827/2
∅ 40 x 8 mm

B

Art. 1827/7
∅ 30 x 8 mm
Art. 1827/8
∅ 40 x 8 mm

hammered on 4 corners and 2 sides
magliato e spigolato su entrambi i lati



A

Art. 1827/3
∅ 30 x 8 mm
Art. 1827/4
∅ 40 x 8 mm

B

Art. 1827/9
∅ 30 x 8 mm
Art. 1827/10
∅ 40 x 8 mm



Art. 654/5
 Ø 60 mm
 6 mm

Ends welded on Art. 654/5
 Estremità saldate su art. 654/5

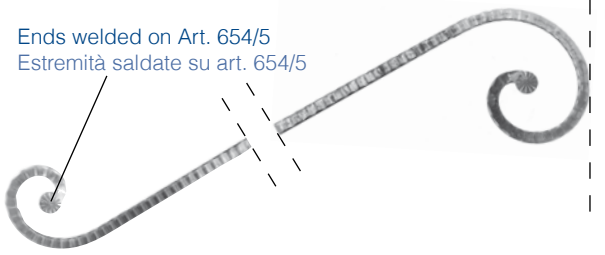

Art. 653/1
 30 x 8 mm
 410 x 900 mm

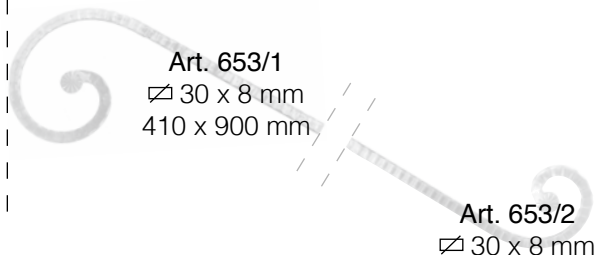

Art. 653/2
 30 x 8 mm
 270 x 650 mm

Art. 118/A/6
 30 x 8 mm
 L 3000 mm

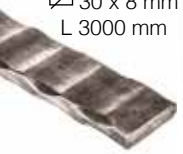

Hammered bar
 on both sides
 and corners
 barra magliata
 e spigolata su
 entrambi i lati

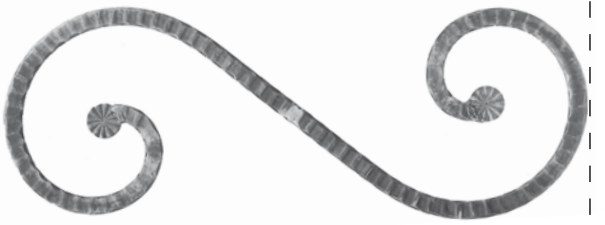

Art. 653/4
 30 x 8 mm
 360 x 1500 mm

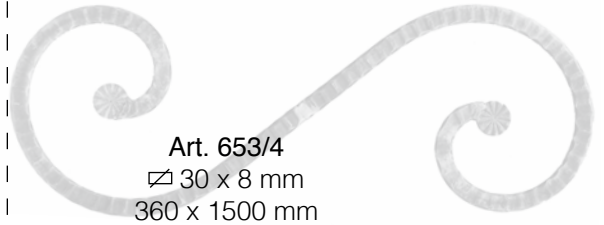

Art. 653/3
 30 x 8 mm
 240 x 1500 mm

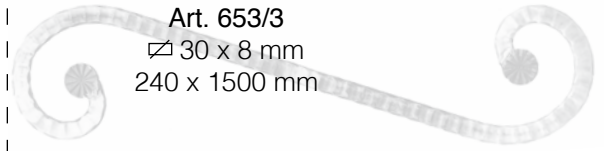

Art. 654/1
 30 x 8 mm
 370 x 1500 mm

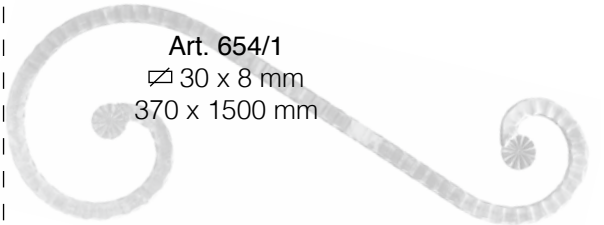

Ends welded on Art. 654/5
Estremità saldate su art. 654/5

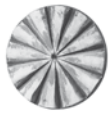

Art. 654/5
Ø 60 mm
6 mm

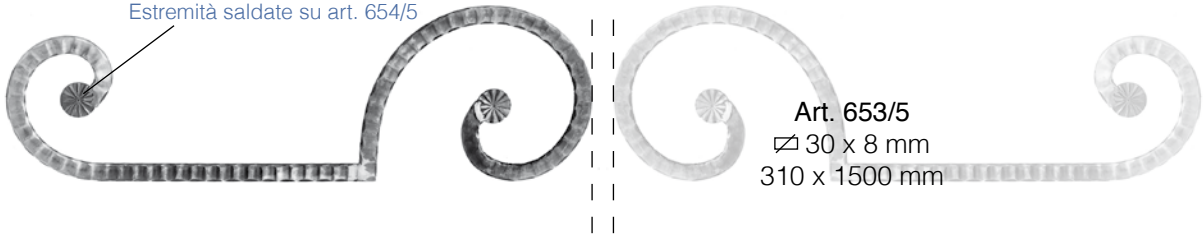

Art. 653/5
30 x 8 mm
310 x 1500 mm

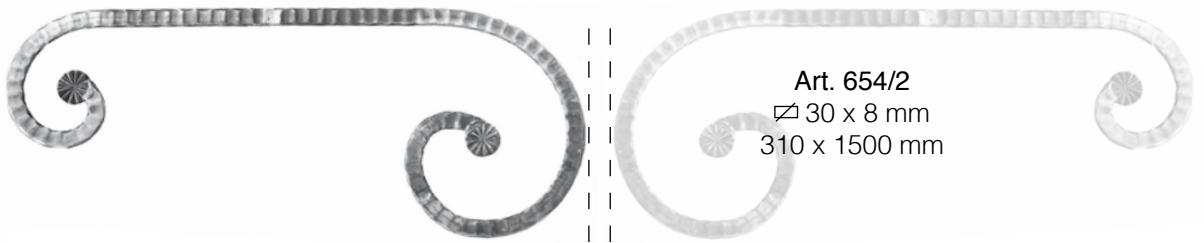

Art. 654/2
30 x 8 mm
310 x 1500 mm

Art. 118/A/6
30 x 8 mm
L 3000 mm

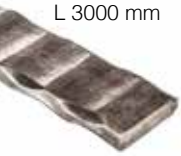

Hammered bar
on both sides
and corners
barra magliata
e spigolata su
entrambi i lati

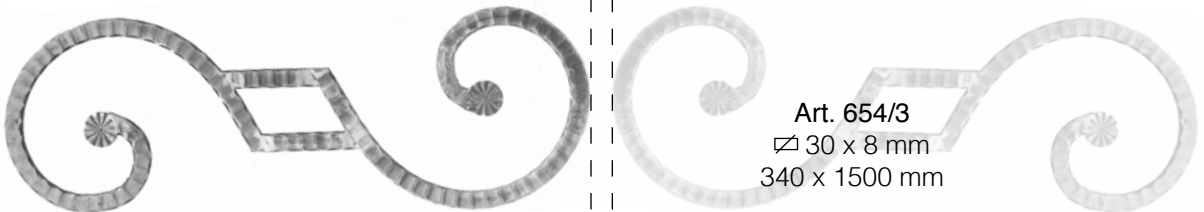

Art. 654/3
30 x 8 mm
340 x 1500 mm

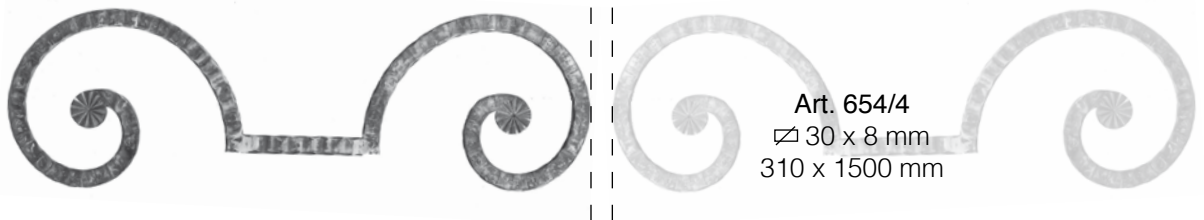

Art. 654/4
30 x 8 mm
310 x 1500 mm

i

Pag.
245

In section 17
you'll find
the accessories
for the gates
Nel capitolo 17
troverai
gli accessori
per i cancelli





left - sinistro
Art. GD285/2
 ⌀ 14 mm + ▧ 14 x 8 mm
 700 x 1360 mm



right - destra
Art. GD285/2/S
 ⌀ 14 mm + ▧ 14 x 8 mm
 700 x 1360 mm



left - sinistro
Art. 1281/11
 ▧ 20 x 8 mm
 310 x 1100 mm



right - destra
Art. 1281/12
 ▧ 20 x 8 mm
 310 x 1100 mm



left - sinistro
Art. 1281/5
 ▧ 20 x 8 mm
 430 x 1230 mm



right - destra
Art. 1281/6
 ▧ 20 x 8 mm
 430 x 1230 mm



left - sinistro
Art. 1281/7
 ▧ 20 x 8 mm
 250 x 750 mm



right - destra
Art. 1281/8
 ▧ 20 x 8 mm
 250 x 750 mm

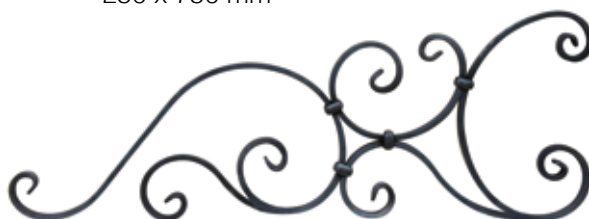

left - sinistro
Art. 1281/9
 ▧ 20 x 8 mm
 310 x 850 mm

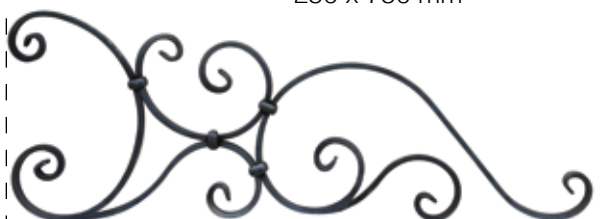

right - destra
Art. 1281/10
 ▧ 20 x 8 mm
 310 x 850 mm

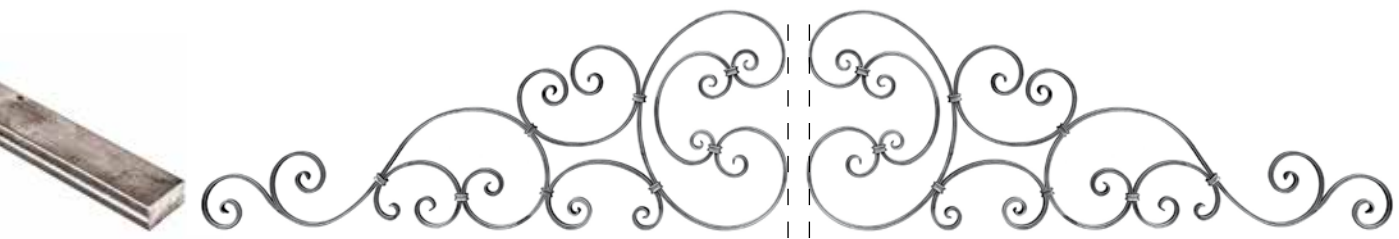

Art. 1369/2
 16 x 8 mm
 L 3000 mm

left - sinistro
 Art. 1281/2/S2
 16 x 8 mm
 440 x 1260 mm



right - destro
 Art. 1281/2
 16 x 8 mm
 440 x 1260 mm

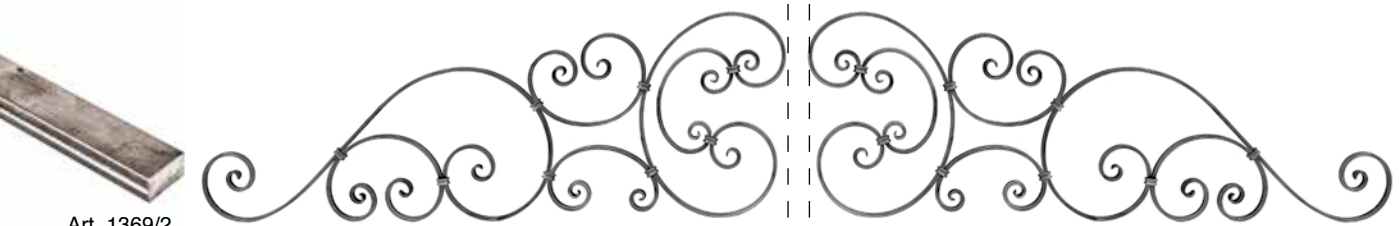

Art. 1369/2
 16 x 8 mm
 L 3000 mm

left - sinistro
 Art. 1281/1/S
 16 x 8 mm
 445 x 1300 mm



right - destro
 Art. 1281/1
 16 x 8 mm
 445 x 1300 mm

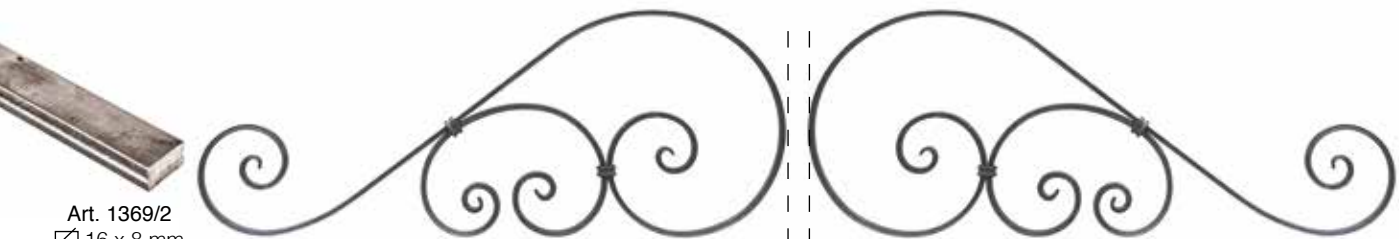

Art. 1369/2
 16 x 8 mm
 L 3000 mm

left - sinistro
 Art. 1281/3/S
 16 x 8 mm
 340 x 830 mm

right - destro
 Art. 1281/3
 16 x 8 mm
 340 x 830 mm



Art. 1369/2
 16 x 8 mm
 L 3000 mm

left - sinistro
 Art. 1281/4/S2
 16 x 8 mm
 260 x 760 mm

right - destro
 Art. 1281/4
 16 x 8 mm
 260 x 760 mm





Art. 1279/4
 ∅ 20 x 6 mm
 235 x 720 mm

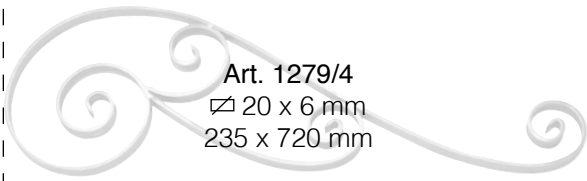

Art. 1279/3
 ∅ 20 x 6 mm
 190 x 450 mm

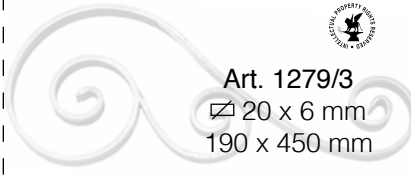

Art. 116/D/1
 ∅ 20 x 6 mm
 450 x 1280 mm

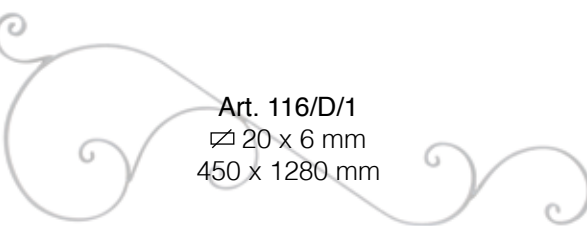

Hammered
 Martellato
 118/12
 ∅ 20 x 6 mm



with leaves - con foglie
 art. 136/3 and/e 136/4

Art. 116/D/2
 ∅ 20 x 6 mm
 450 x 1280 mm

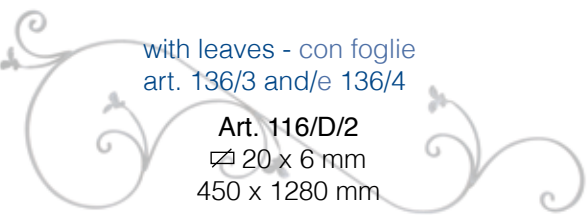

Hammered
 Martellato
 118/12
 ∅ 20 x 6 mm



Art. 116/E/6
 ∅ 30 x 8 mm
 280 x 810 mm



Not all of the Arteferro items are available in **Arteferro Quick**, just a special selection.

Find out about the entire range in the catalogue

In **Arteferro Quick** non sono presenti tutti gli articoli Arteferro, ma solo una speciale selezione. Scopri la gamma completa nel catalogo

Compendium



We also produce customised overthrows

Facciamo anche cimase su misura



Art. 1281/14
 □ 20 x 8 mm
 240 x 800 mm



Art. 116/E/2
 □ 12 x 6 mm
 240 x 1030 mm



Art. GD271/1
 □ 16 x 6 mm
 200 x 770 mm



Art. 116/E/3
 □ 20 x 8 mm
 300 x 800 mm



Art. GD271/2
 □ 16 x 6 mm
 220 x 830 mm



Art. 116/E/4
 □ 12 x 6 mm
 200 x 700 mm



Art. GD271/3
 □ 16 x 6 mm
 320 x 1100 mm



Art. 116/E/1
 □ 20 x 8 mm
 350 x 1000 mm



Art. 696/1
 □ 16 x 8 mm
 280 x 920 mm



Art. 1281/13
 □ 20 x 8 mm
 290 x 980 mm



Arteferro pickets and panels are amongst the most important items in the composition of an infill of a balustrade or fence. The classic design means you can create structures with a refined taste and an unmistakable and timeless style, typical of traditional wrought iron items.

I paletti e pannelli Arteferro sono tra gli elementi più importanti nella composizione del tamponamento di un parapetto o di una recinzione. Il design classico consente di realizzare strutture dal gusto ricercato e dallo stile inconfondibile ed intramontabile, tipico dei manufatti in ferro battuto tradizionali.

PALETTI E PANNELLI CLASSICI CLASSICAL PICKETS AND PANELS

4.

Classical Pickets and Panels
Paletti e Pannelli classici

| | | |
|-----------------------------|--------------------------------------|---------|
| A Forged pickets | Paletti forgiati | pag.72 |
| B Stamped pickets | Paletti conati | pag.80 |
| C Tube pickets | Paletti in tubo | pag.92 |
| D Pickets with twisting | Paletti con torciglione | pag.94 |
| E Pickets with big twisting | Paletti con torciglione grande | pag.100 |
| F Pickets with baskets | Paletti con pigna | pag.102 |
| G "S" shaped panels | Pannelli ad "esse" | pag.105 |
| H Panels with scrolls | Pannelli con ricci | pag.110 |



A lot of pickets and panels have been classified to make it easier for you to find what you want quickly and easily. Starting with the central motif, you can find your article by process as well as matching decorations.

Molti paletti e pannelli sono stati classificati per dare la possibilità di trovare in modo veloce e pratico l'articolo desiderato. Parti dal motivo centrale troverai il tuo articolo con la lavorazione e i decori abbinabili.



Not all of the Arterferro items are available in **Arterferro Quick**, just a special selection. Find out about the entire range in the catalogue

In **Arterferro Quick** non sono presenti tutti gli articoli Arterferro, ma solo una speciale selezione. Scopri la gamma completa nel catalogo

Compendium

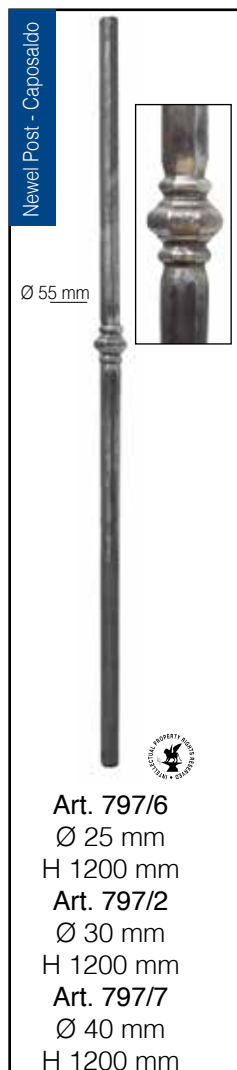
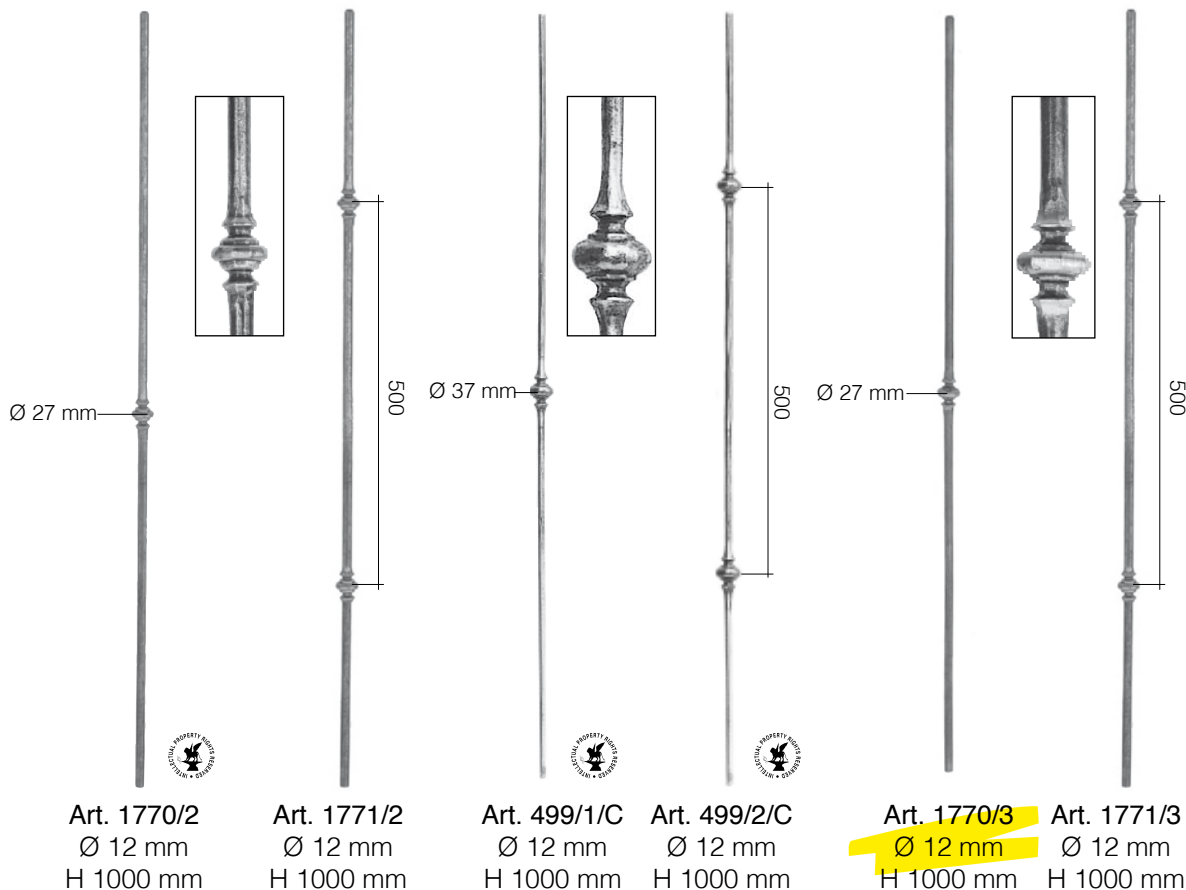

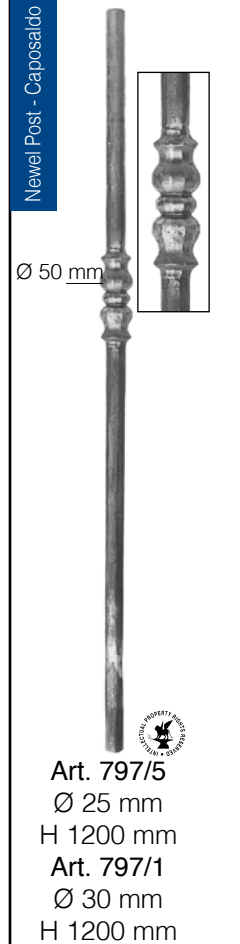
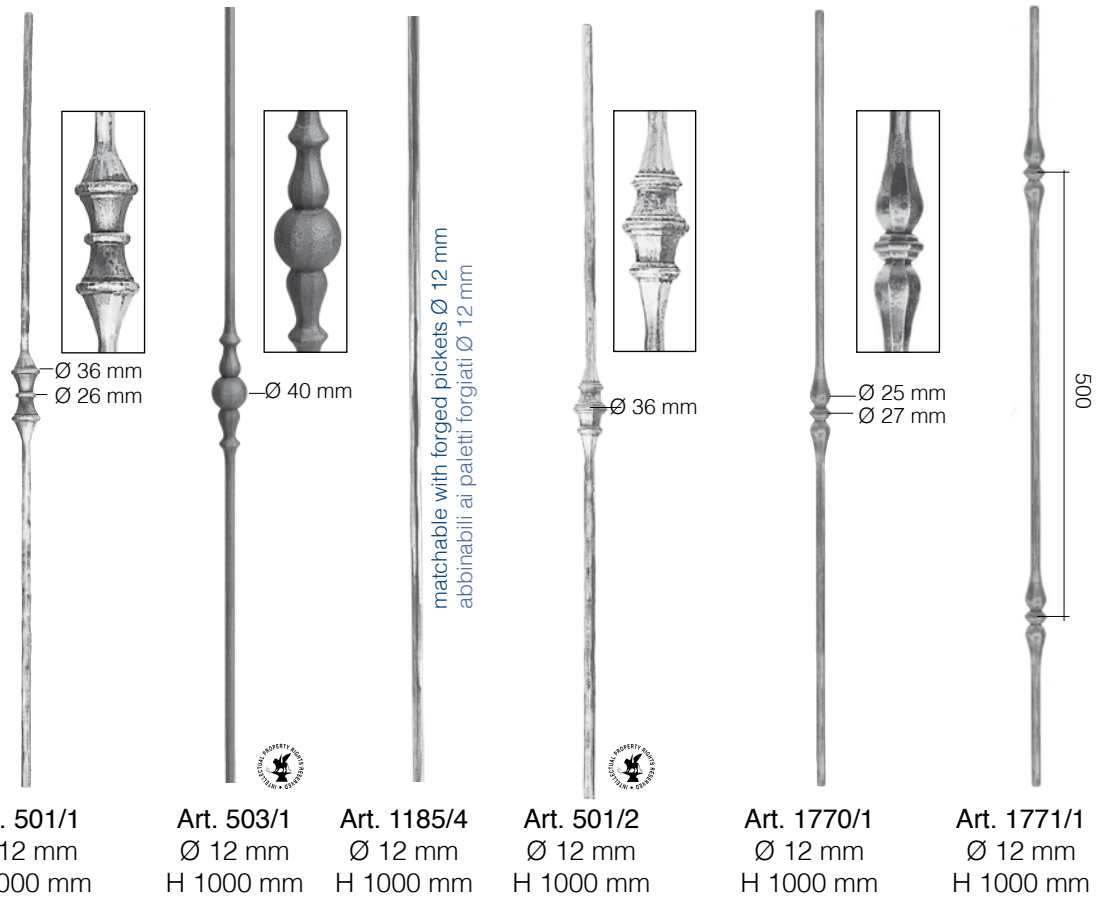
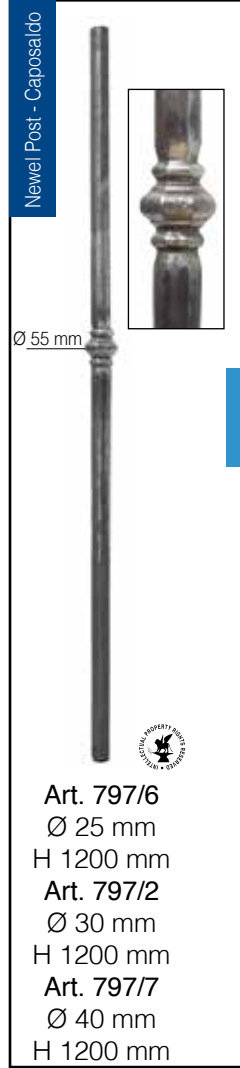
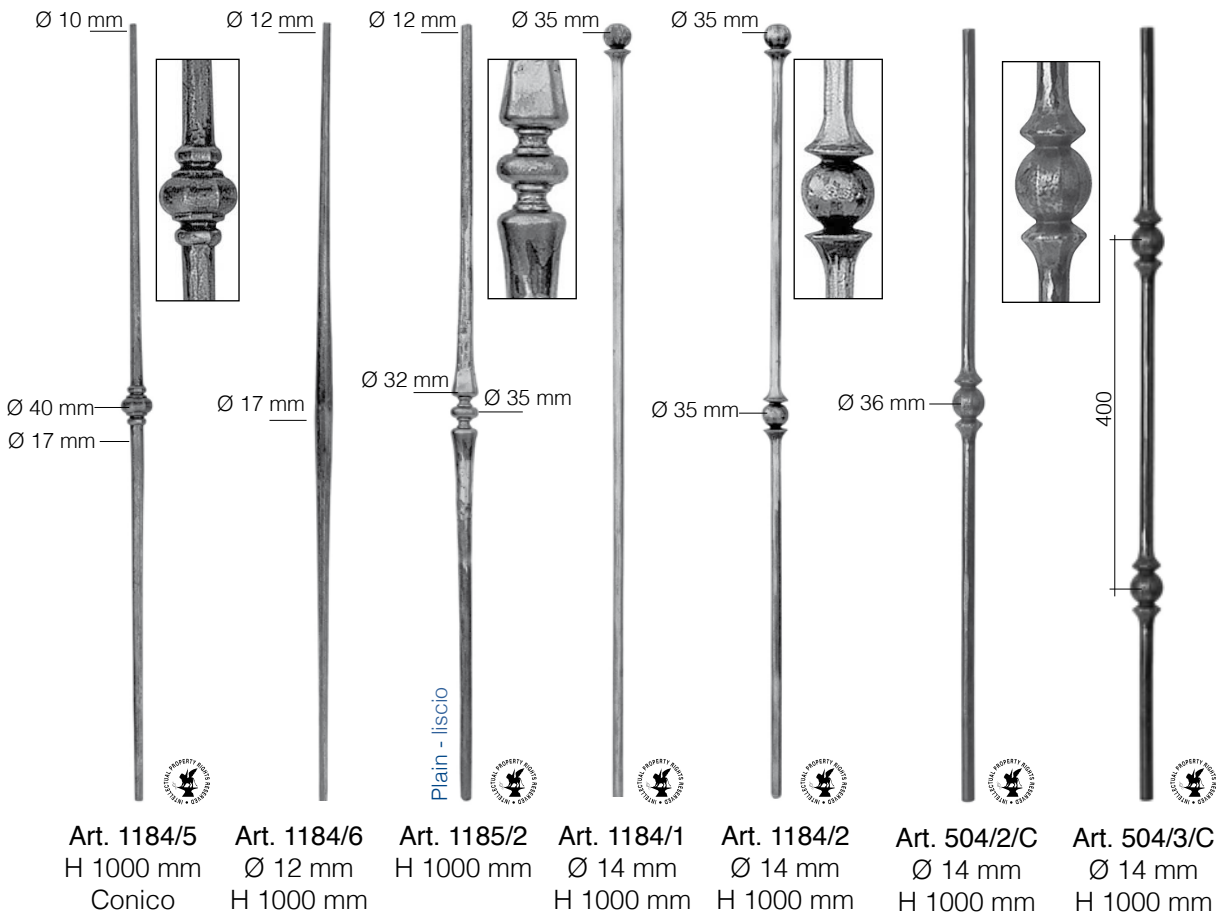

Forged pickets - Paletti forgiati

Art. 497/1/C
 Ø 12 mm
 H 1000 mm

Art. 497/2/C
 Ø 12 mm
 H 1000 mm

Art. 1770/10
 Ø 14 mm
 H 1000 mm

Art. 1770/9
 Ø 14 mm
 H 1000 mm

Art. 508/3/C
 Ø 14 mm
 H 1000 mm

Art. 508/4/C
 Ø 14 mm
 H 1000 mm

Art. 797/5
 Ø 25 mm
 H 1200 mm

Art. 797/1
 Ø 30 mm
 H 1200 mm

Art. 598/1
 Ø 12 mm
 L 3000 mm
Art. 598/6
 Ø 25 mm
 L 3000 mm
Art. 598/7
 Ø 30 mm
 L 3000 mm

Art. 1187/3
 H 1000 mm

Art. 496/C/1/C
 H 1000 mm

Art. 496/C/2/C
 H 1000 mm

Art. 496/C/3/C
 H 1000 mm

Art. 797/4
 Ø 30 mm
 H 1200 mm

Art. 1199/3
 Ø 26 mm
 H 1200 mm

Power long hammering to extend posts and pickets

Lavorazione manuale magliatura piatta allungata per allungamento caposaldi e paletti



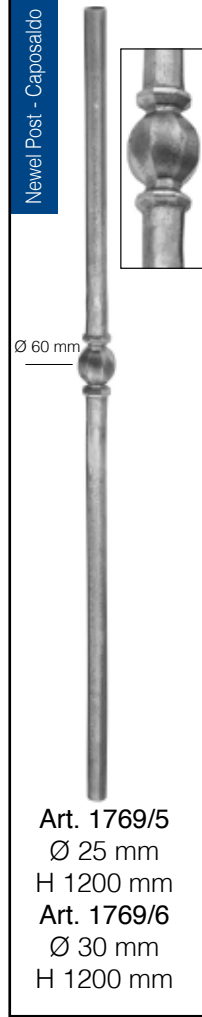
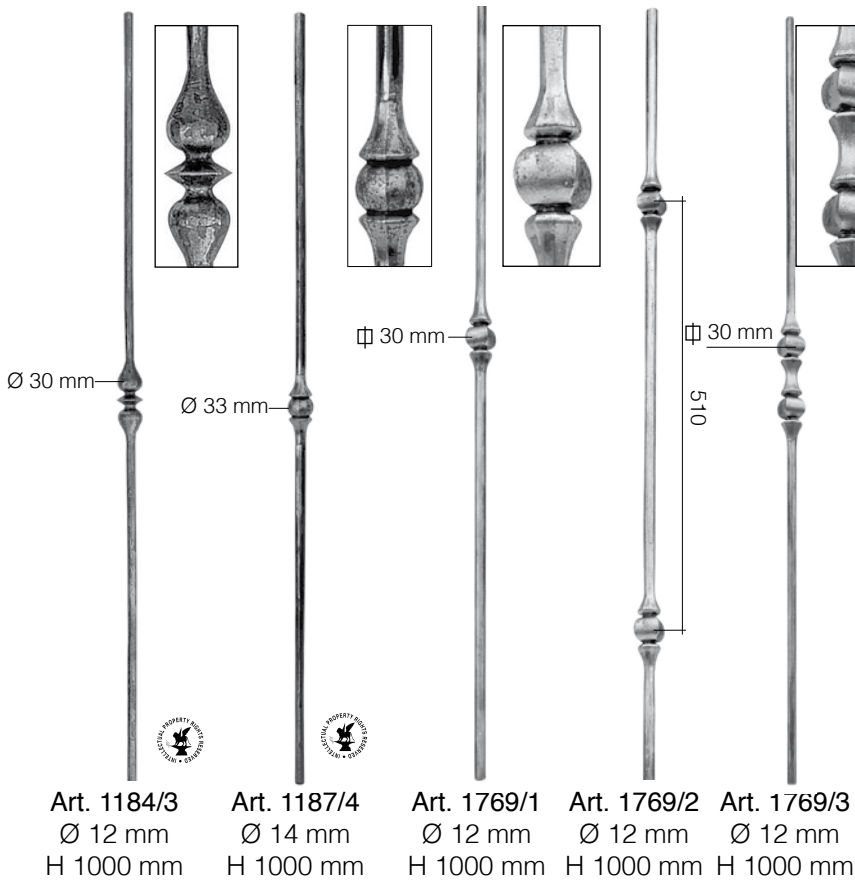

Art. 1184/3 Ø 12 mm H 1000 mm
 Art. 1187/4 Ø 14 mm H 1000 mm
 Art. 1769/1 Ø 12 mm H 1000 mm
 Art. 1769/2 Ø 12 mm H 1000 mm
 Art. 1769/3 Ø 12 mm H 1000 mm

Art. 1769/5 Ø 25 mm H 1200 mm
 Art. 1769/6 Ø 30 mm H 1200 mm

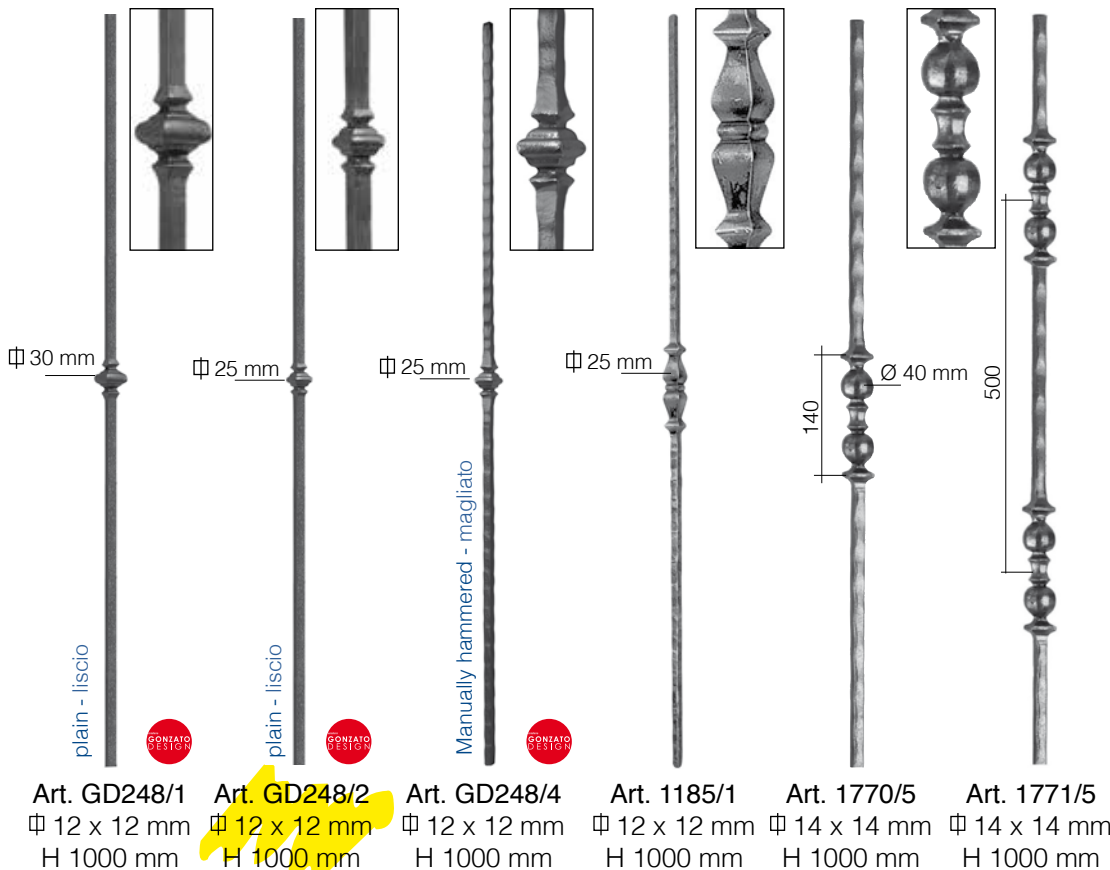

Art. 1370/11
 □ 25 x 25 mm
 L 2000 mm
 Art. 1370/12
 □ 30 x 30 mm
 L 2000 mm

Manually hammered square bar to match with posts

Quadro magliato manualmente per abbinamento caposaldi

Art. GD248/1 □ 12 x 12 mm H 1000 mm
 Art. GD248/2 □ 12 x 12 mm H 1000 mm
 Art. GD248/4 □ 12 x 12 mm H 1000 mm
 Art. 1185/1 □ 12 x 12 mm H 1000 mm
 Art. 1770/5 □ 14 x 14 mm H 1000 mm
 Art. 1771/5 □ 14 x 14 mm H 1000 mm

Art. 112/11 □ 25 x 25 mm H 1200 mm

Forged pickets - Paletti forgiati

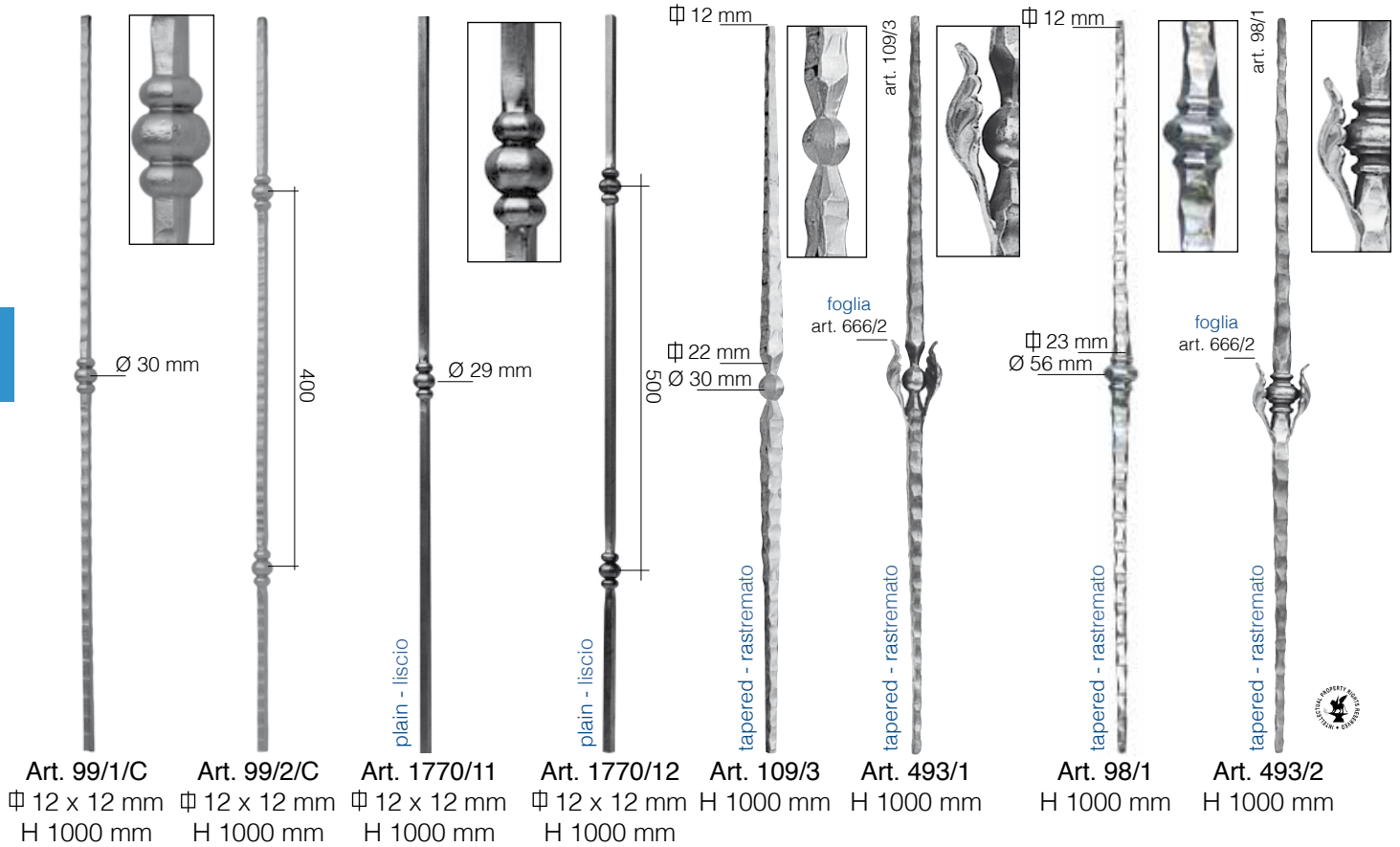

Art. 99/1/C Ø 30 mm
 Art. 99/2/C 400
 Art. 1770/11 plain - liscio Ø 29 mm
 Art. 1770/12 plain - liscio 500
 Art. 109/3 tapered - rastremato Ø 12 mm Ø 22 mm Ø 30 mm
 Art. 493/1 tapered - rastremato foglia art. 666/2
 Art. 98/1 tapered - rastremato Ø 12 mm Ø 23 mm Ø 56 mm
 Art. 493/2 tapered - rastremato foglia art. 666/2

Art. 99/1/C
 Ø 12 x 12 mm
 H 1000 mm

Art. 99/2/C
 Ø 12 x 12 mm
 H 1000 mm

Art. 1770/11
 Ø 12 x 12 mm
 H 1000 mm

Art. 1770/12
 Ø 12 x 12 mm
 H 1000 mm

Art. 109/3
 H 1000 mm

Art. 493/1
 H 1000 mm

Art. 98/1
 H 1000 mm

Art. 493/2
 H 1000 mm

 The first forged picket in our factory was art. 98/1 and still in production
 Il primo paletto forgiato nelle nostre fucine è stato l'art. 98/1 ancora oggi in produzione

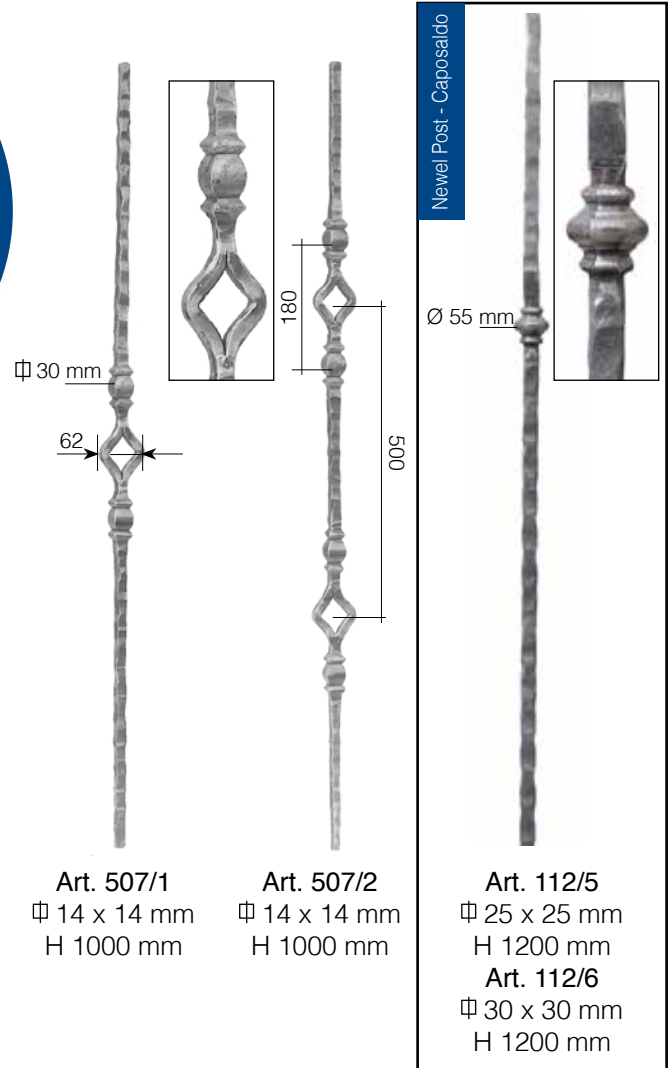
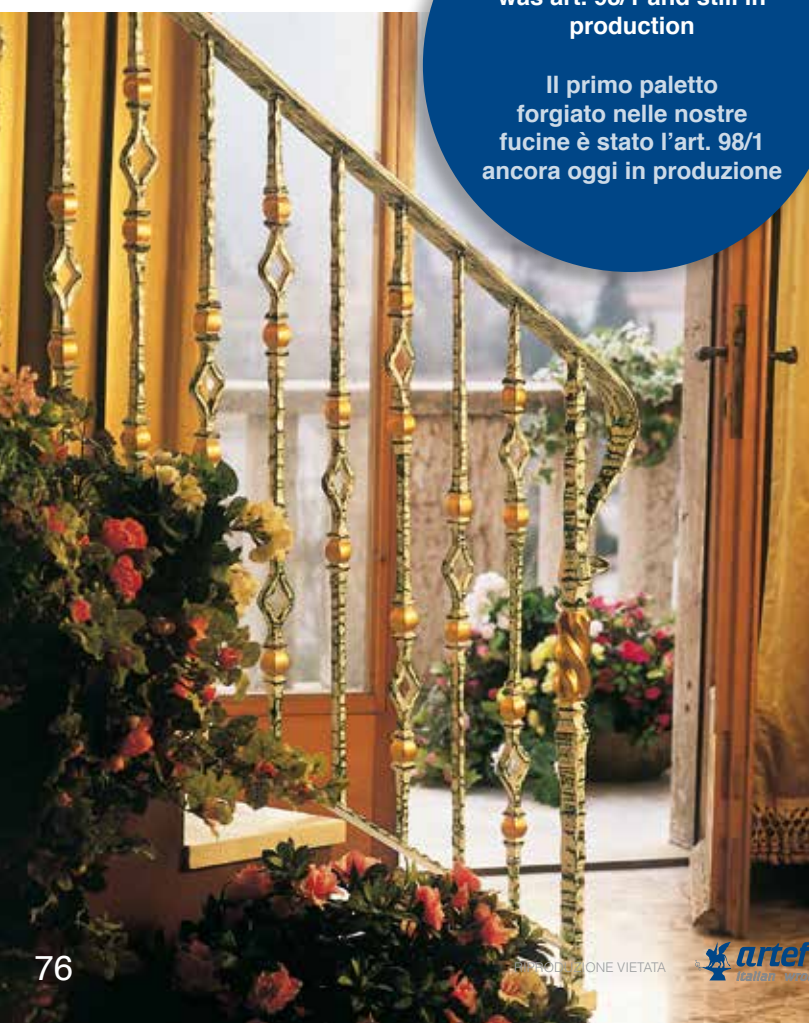

Art. 507/1
 Ø 30 mm
 H 1000 mm

Art. 507/2
 Ø 30 mm
 H 1000 mm

Art. 112/5
 Ø 55 mm
 H 1200 mm
 Art. 112/6
 Ø 30 x 30 mm
 H 1200 mm

Newel Post - Caposaldo

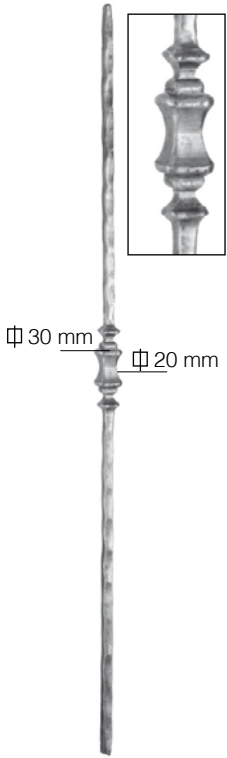

Art. 110/3
 Ø 12 x 12 mm
 H 1000 mm

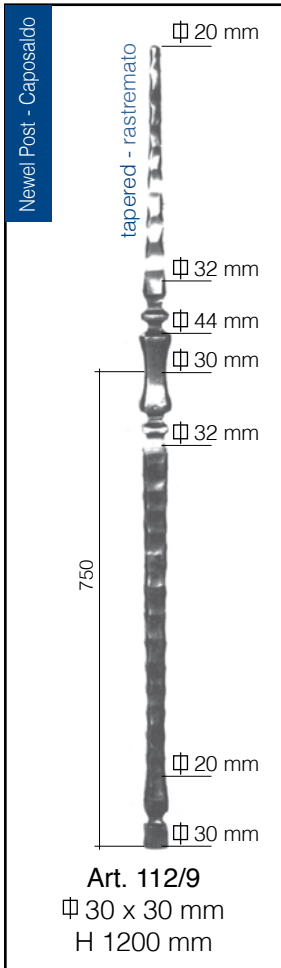

Art. 112/9
 Ø 30 x 30 mm
 H 1200 mm

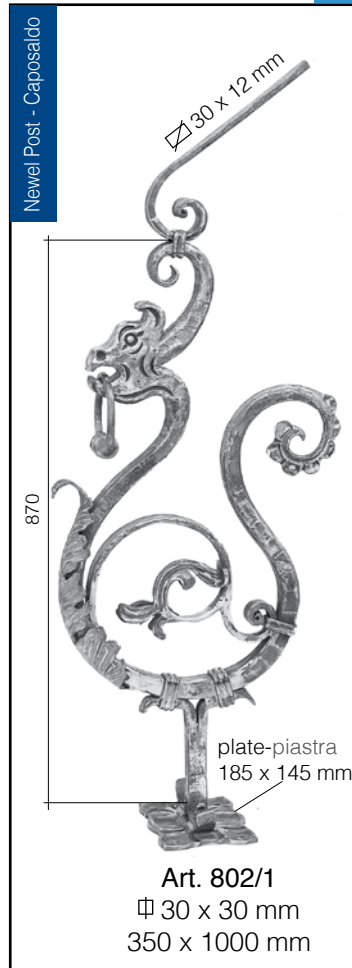

Art. 802/1
 Ø 30 x 30 mm
 350 x 1000 mm

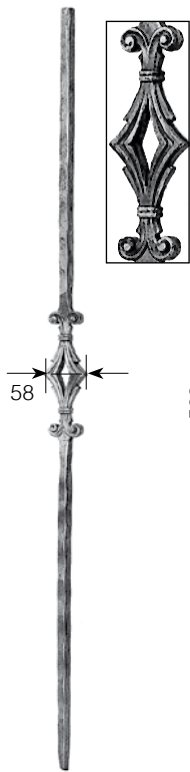

Art. 489/2
 Ø 14 x 14 mm
 H 1000 mm

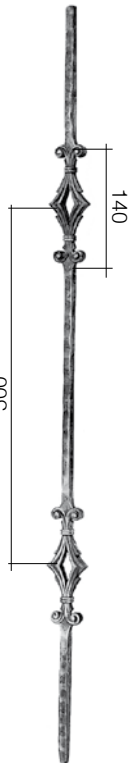

Art. 489/1
 Ø 14 x 14 mm
 H 1000 mm

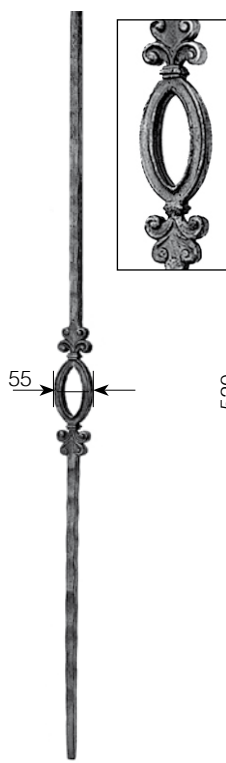

Art. 490/2
 Ø 14 x 14 mm
 H 1000 mm

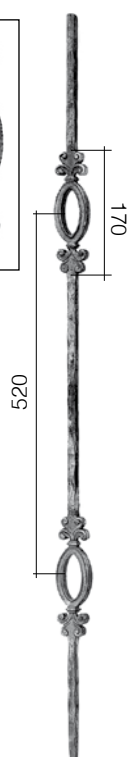

Art. 490/1
 Ø 14 x 14 mm
 H 1000 mm

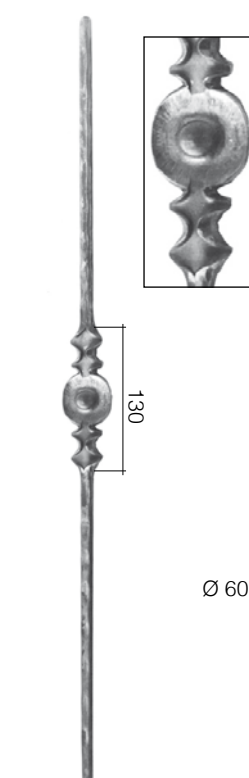

Art. 104/3
 Ø 12 x 12 mm
 H 1000 mm

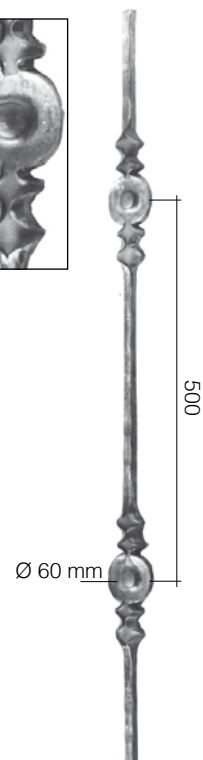

Art. 104/4
 Ø 12 x 12 mm
 H 1000 mm

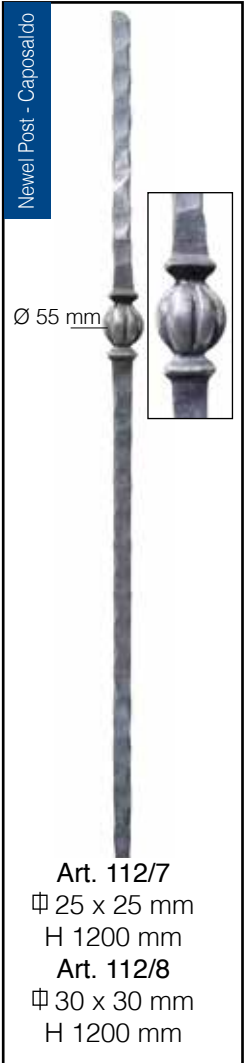

Art. 112/7
 Ø 25 x 25 mm
 H 1200 mm
 Art. 112/8
 Ø 30 x 30 mm
 H 1200 mm

Forged pickets - Paletti forgiati

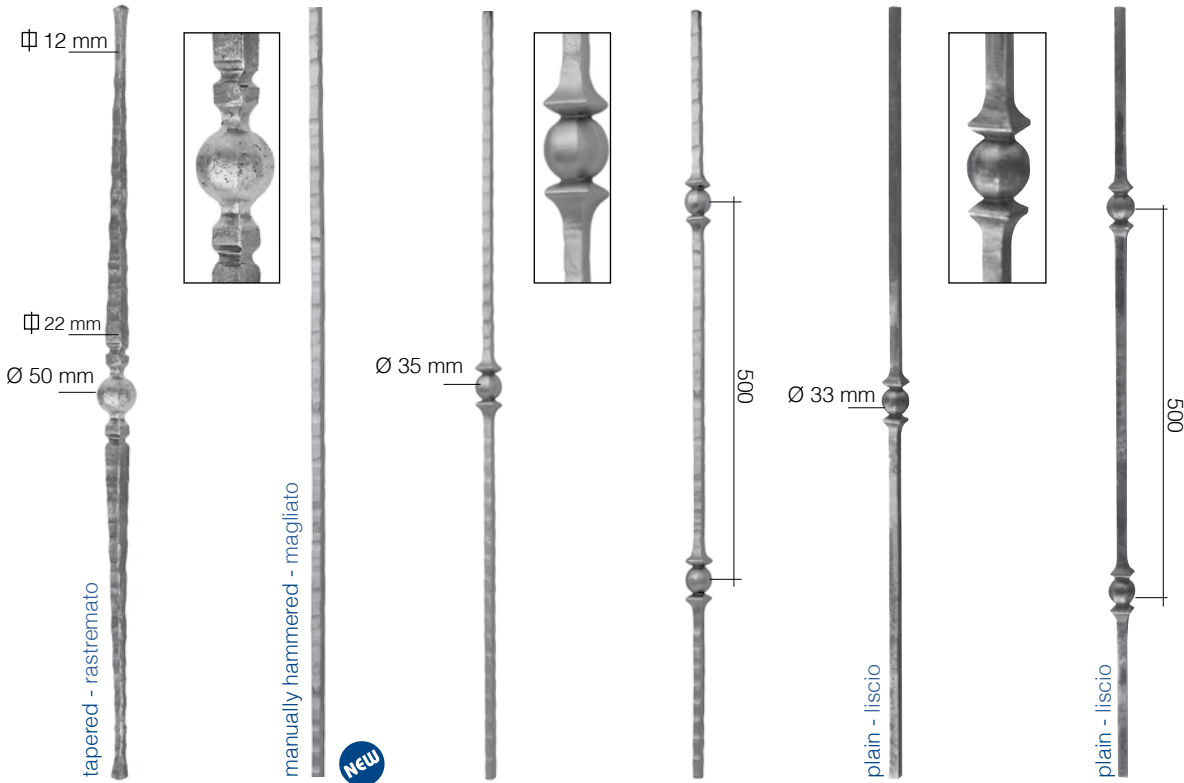

Art. 508/1
H 1000 mm

Art. 105/5/C
Ø 12 x 12 mm
H 1000 mm

Art. 105/2/C
Ø 12 x 12 mm
H 1000 mm

Art. 105/1/C
Ø 12 x 12 mm
H 1000 mm

Art. 1770/15
Ø 12 x 12 mm
H 1000 mm

Art. 1770/13
Ø 12 x 12 mm
H 1000 mm

Art. 105/3
Ø 14 x 14 mm
H 1000 mm

Art. 1770/16
Ø 14 x 14 mm
H 1000 mm

Art. 1770/14
Ø 14 x 14 mm
H 1000 mm

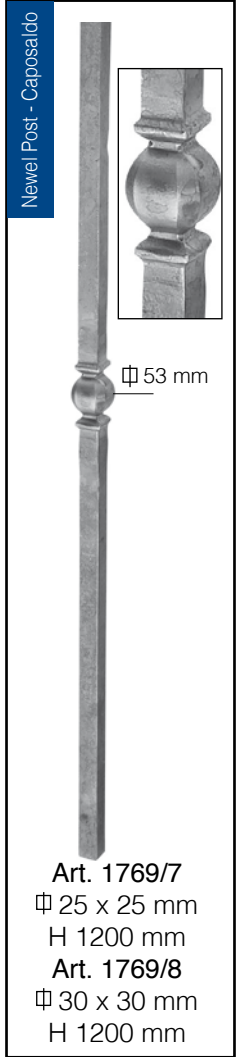

Art. 1769/7
Ø 25 x 25 mm
H 1200 mm

Art. 1769/8
Ø 30 x 30 mm
H 1200 mm



Art. 509/1
Ø 12 x 12 mm
160 x 1000 mm

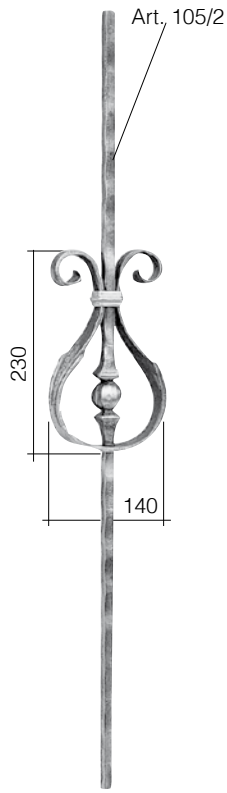

Art. 494/1
Ø 12 x 12 mm
140 x 1000 mm

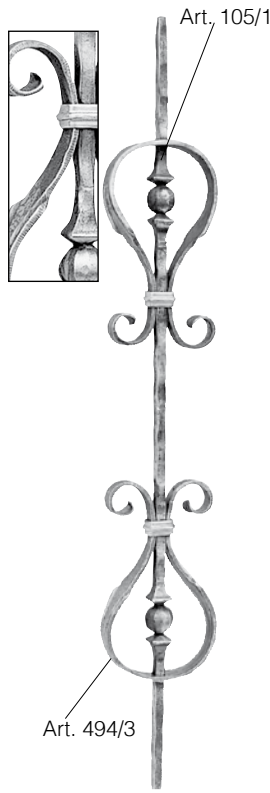

Art. 494/2
Ø 12 x 12 mm
140 x 1000 mm



Art. 492/2
Ø 12 x 12 mm
H 1000 mm

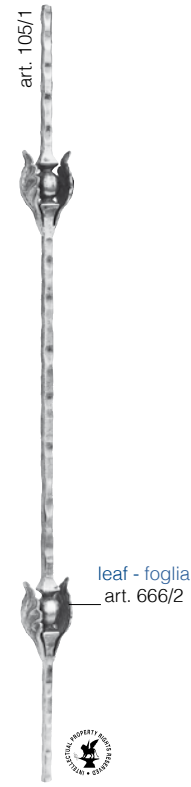

Art. 492/1
Ø 12 x 12 mm
H 1000 mm



Art. 801/6
Ø 30 x 30 mm
H 1200 mm

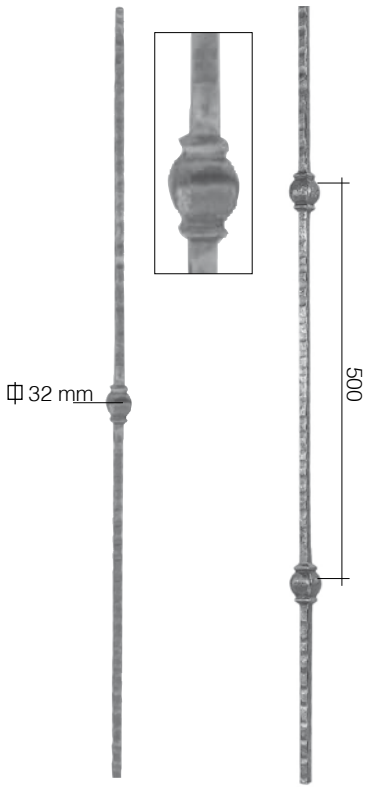

Art. 1770/8
 Ø 12 x 12 mm
 H 1000 mm

Art. 1771/8
 Ø 12 x 12 mm
 H 1000 mm



Art. 1199/2
 Ø 25 x 25 mm
 H 1200 mm

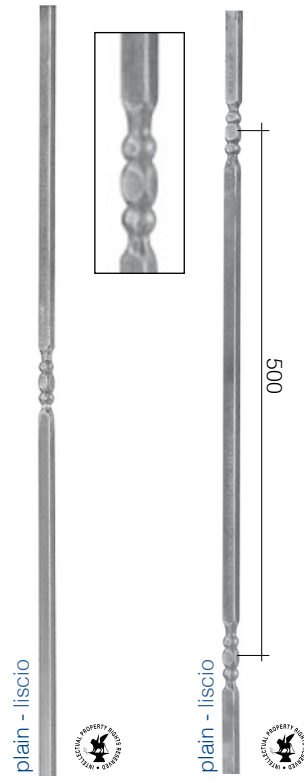

Art. 1773/6
 Ø 12 x 12 mm
 H 1000 mm

Art. 1773/5
 Ø 12 x 12 mm
 H 1000 mm

Art. 1773/2
 Ø 14 x 14 mm
 H 1000 mm

Art. 1773/1
 Ø 14 x 14 mm
 H 1000 mm



Art. 505/1
 Ø 14 x 14 mm
 H 1000 mm

Art. 505/2
 Ø 14 x 14 mm
 H 1000 mm



Art. 800/4
 Ø 30 x 30 mm
 H 1200 mm

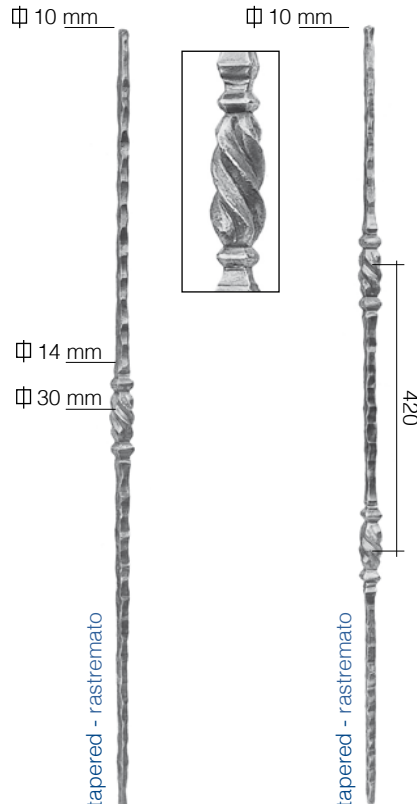

Art. 505/3
 Ø 14 x 14 mm
 H 1000 mm

Art. 505/4
 Ø 14 x 14 mm
 H 1000 mm

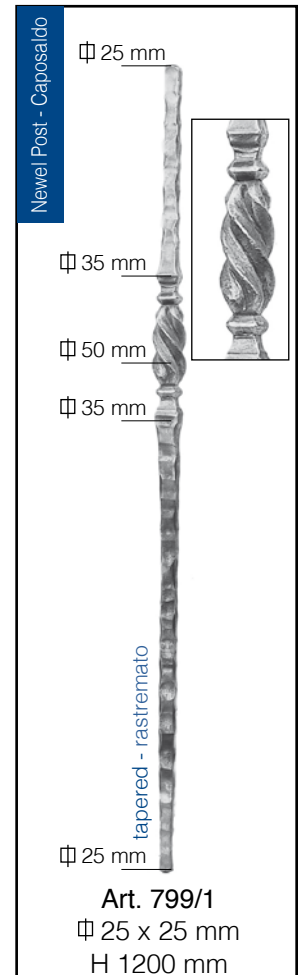

Art. 799/1
 Ø 25 x 25 mm
 H 1200 mm

Stamped pickets - Paletti conati

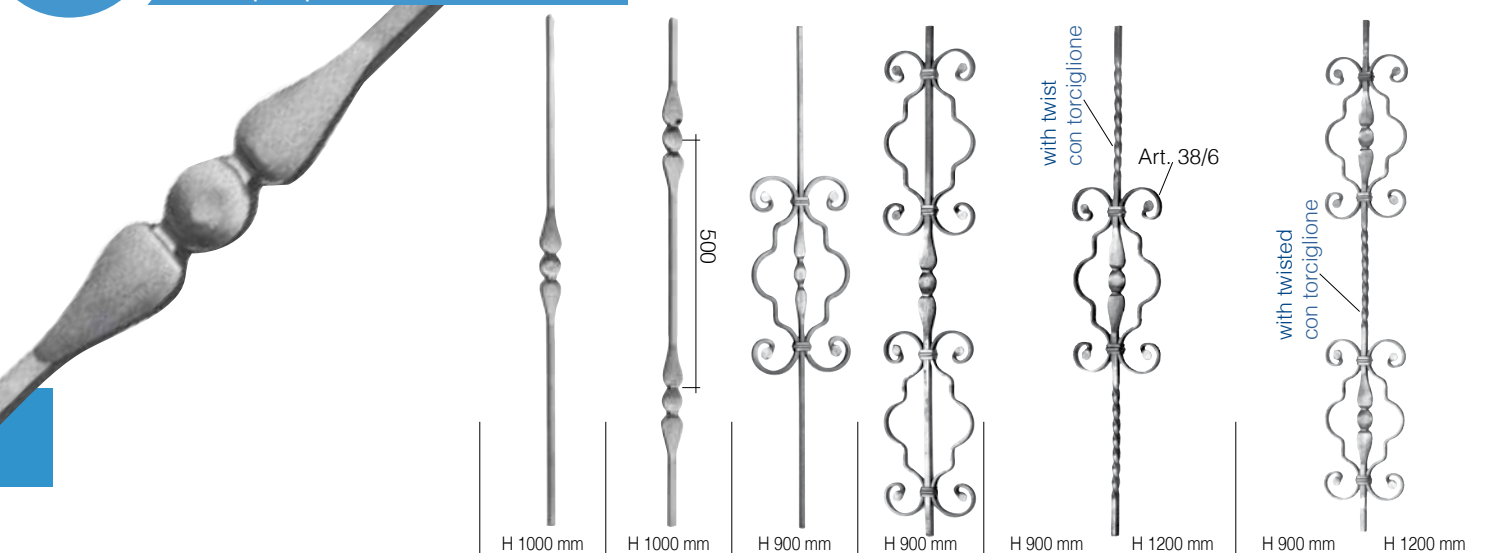

| Sec.Sez. | Finish - Finitura | Art. | Art. | Art. | Art. | Art. | Art. | Art. | Art. |
|----------|--|------|---------|---------|---------|---------|---------|---------|---------|
| Ø 12 mm | Plain - Liscio | | 134/2 | 134/10 | 134/B/2 | 134/B/4 | 134/C/2 | 134/C/3 | 134/C/5 |
| | Stamped on plain edge Stampato sullo spigolo liscio | | 1749/11 | 1749/9 | | | | | |
| | Hammered - Spigolato | | 587/42 | 587/46 | | | | | |
| | Bark effect - Corteccia | | 1251/1 | 1251/2 | | | | | |
| | Four-leaf clover - Quadrifoglio | | - | - | | | | | |
| Ø 14 mm | Plain - Liscio | | 1251/9 | 1251/10 | | | | | |
| | Stamped on plain edge Stampato sullo spigolo liscio | | 134/4 | 134/12 | 1749/12 | 1749/10 | | | |
| | Hammered - Spigolato | | 587/44 | 587/48 | | | | | |
| | Bark effect - Corteccia | | 1251/3 | 1251/4 | | | | | |
| | Four-leaf clover - Quadrifoglio | | 1251/7 | 1251/8 | | | | | |
| Ø 14 mm | Plain - Liscio | | 1251/11 | 1251/12 | | | | | |







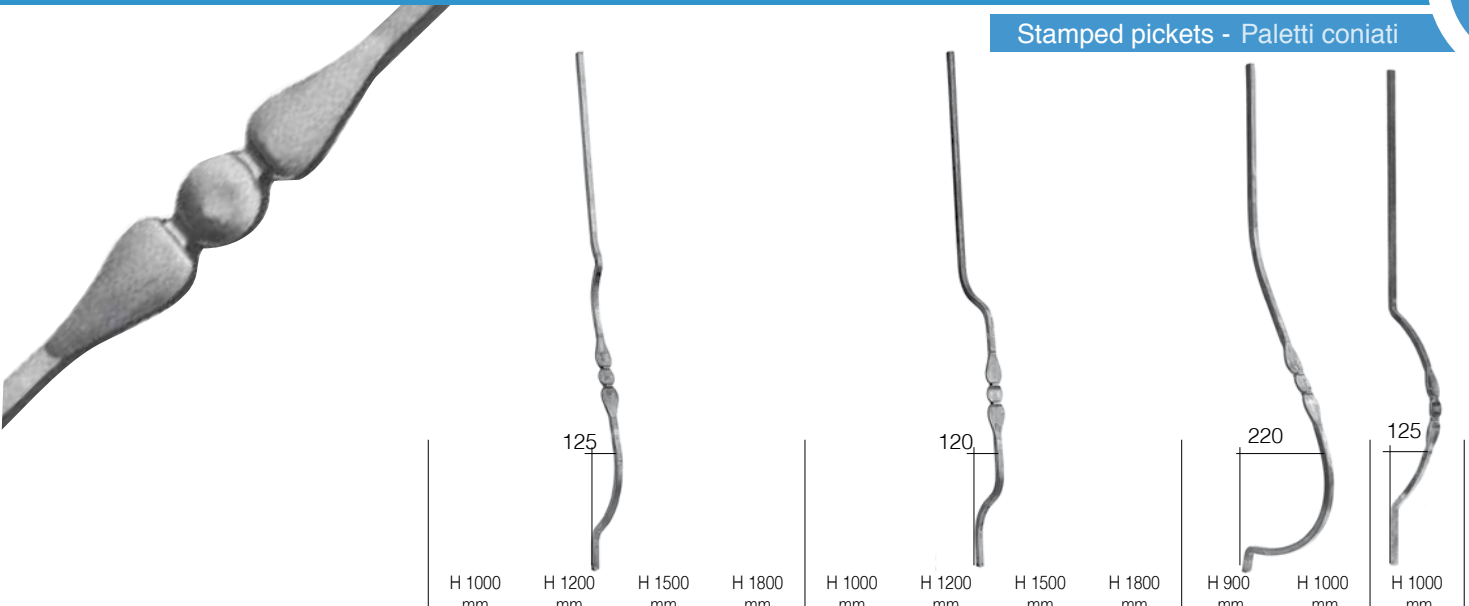

| Sec.Sez. | Finish - Finitura | Art. | Art. | Art. | Art. |
|----------|-------------------|------|-------|---------|-------|
| Ø 12 mm | Plain - Liscio | | 586/1 | 134/D/9 | 585/1 |
| | | | | | 585/2 |
| | | | | | |
| | | | | | |

i Arteferro products can be manufactured as well as customised.
I prodotti Arteferro sono realizzabili anche su misura.

Stamped pickets - Paletti conati



| Sec.Sez. | Finish - Finitura | Art. | Art. | Art. | Art. | Art. | Art. | Art. | Art. | Art. | Art. | Art. |
|----------|---|--------|--------|--------|--------|--------|--------|--------|--------|--------|--------|--------|
| Φ 12 mm | Plain Liscio  | 587/2 | 587/5 | 587/6 | 587/7 | 587/22 | 587/25 | 587/26 | 587/27 | 586/14 | 586/6 | 586/8 |
| | Hammered Spigolato  | 587/12 | 587/15 | 587/16 | 587/17 | 587/24 | 587/28 | 587/29 | 587/30 | - | - | - |
| Ø 12 mm | Plain Liscio  | - | - | - | - | - | - | - | - | - | 586/12 | 586/10 |
| Φ 14 mm | Plain Liscio  | 587/4 | 587/8 | 587/9 | 587/10 | 587/32 | 587/35 | 587/36 | 587/37 | 586/15 | 586/7 | 586/9 |
| | Hammered Spigolato  | 587/14 | 587/18 | 587/19 | 587/20 | 587/34 | 587/38 | 587/39 | 587/40 | - | - | - |
| Ø 14 mm | Plain Liscio  | - | - | - | - | - | - | - | - | - | 586/13 | 586/11 |

Newel Post - Caposaldo



H 1200 mm

| Sec.Sez. | Finish - Finitura | Art. |
|----------|--|---------|
| Φ 25 mm | Plain Liscio  | 1775/11 |
| Φ 25 mm | Hammered Spigolato  | 1775/6 |
| Φ 30 mm | Plain Liscio  | 1775/12 |
| Ø 25 mm | Plain Liscio  | 1775/1 |
| Ø 30 mm | Plain Liscio  | 1775/2 |



Stamped pickets - Paletti conati

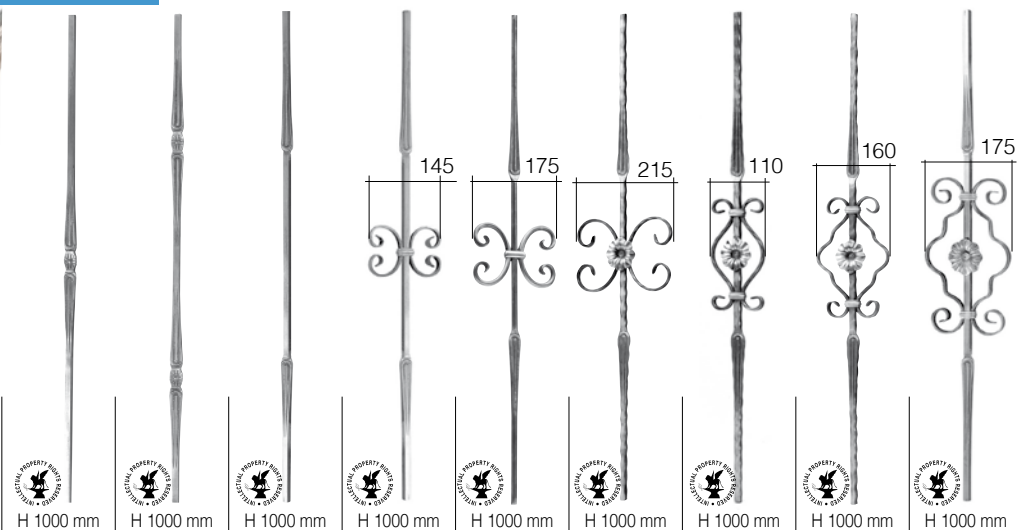

| Sec.Sez. | Finish - Finitura | Art. | Art. | Art. | Art. | Art. | Art. | Art. | Art. | Art. |
|----------|-----------------------|------|---------|---------|---------|--------|---------|---------|---------|---------|
| Φ 12 mm | Plain Liscio | | 1701/1 | 1701/3 | 1701/5 | 1701/7 | - | - | - | 1701/9 |
| | Hammered Spigolato | | 1709/1 | 1709/3 | 1709/5 | - | - | 1709/7 | 1709/9 | 1709/11 |
| | Bark effect Corteccia | | 1710/13 | 1710/5 | 1710/17 | - | - | 1710/19 | 1710/21 | 1710/23 |
| Ø 12 mm | Plain Liscio | | 1716/13 | 1716/15 | 1716/17 | - | 1716/19 | - | - | 1716/21 |
| Φ 14 mm | Plain Liscio | | 1701/2 | 1701/4 | 1701/6 | 1701/8 | - | - | - | 1701/10 |
| | Hammered Spigolato | | 1709/2 | 1709/2 | 1709/6 | - | - | 1709/8 | 1709/10 | 1709/12 |
| | Bark effect Corteccia | | 1710/14 | 1710/16 | 1710/18 | - | - | 1710/20 | 1710/22 | 1710/24 |
| Ø 14 mm | Plain Liscio | | 1716/14 | 1716/16 | 1716/18 | - | 1716/20 | - | - | 1716/22 |

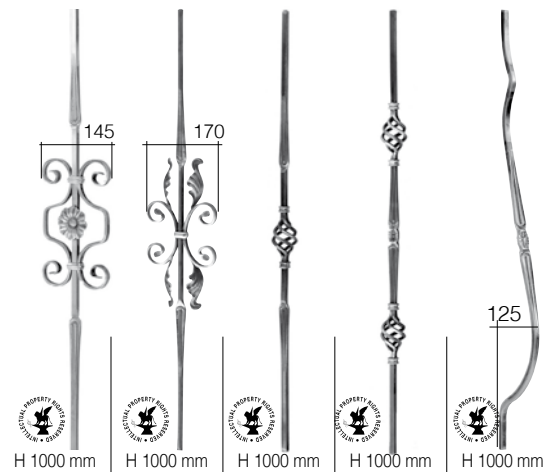

| Sec.Sez. | Finish - Finitura | Art. | Art. | Art. | Art. | Art. |
|----------|-----------------------|------|---------|---------|---------|---------|
| Φ 12 mm | Plain Liscio | | 1701/11 | - | 1733/9 | 1733/11 |
| | Hammered Spigolato | | - | - | - | - |
| | Bark effect Corteccia | | - | - | - | - |
| Ø 12 mm | Plain Liscio | | - | 1716/23 | - | - |
| Φ 14 mm | Plain Liscio | | 1701/12 | - | 1733/10 | 1733/12 |
| | Bark effect Corteccia | | - | - | - | - |
| | Plain Liscio | | - | - | - | - |
| Ø 14 mm | Plain Liscio | | - | 1716/24 | - | - |

Newel Post - Caposaldo

| | | | |
|---------|-----------------------|--|---------|
| Φ 25 mm | Plain Liscio | | 1701/15 |
| | Hammered Spigolato | | 1777/7 |
| | Bark effect Corteccia | | 1777/6 |
| | Plain Liscio | | 1777/2 |

Stamped pickets - Paletti conati

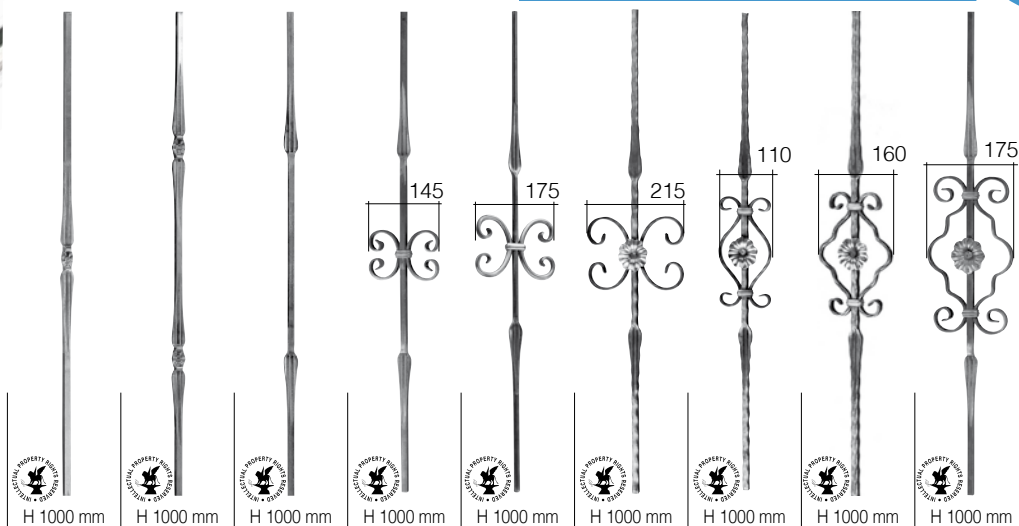

| Sec.Sez. | Finish - Finitura | Art. | Art. | Art. | Art. | Art. | Art. | Art. | Art. | Art. |
|----------|------------------------|--------|--------|--------|--------|--------|---------|---------|---------|---------|
| Φ 12 mm | Plain Liscio | 1705/1 | 1705/3 | 1705/5 | 1705/7 | - | - | - | - | 1705/9 |
| | Hammered Spigolato | 1707/1 | 1707/3 | 1707/5 | - | - | 1707/7 | 1707/8 | 1707/9 | - |
| | Bark effect Cortecchia | 1710/1 | 1710/2 | 1710/5 | - | - | 1710/7 | 1710/9 | 1710/11 | - |
| Ø 12 mm | Plain Liscio | 1716/1 | 1716/3 | 1716/5 | - | 1716/7 | - | - | 1716/9 | - |
| Φ 14 mm | Plain Liscio | 1705/2 | 1705/4 | 1705/6 | 1705/8 | - | - | - | - | 1705/10 |
| | Hammered Spigolato | 1707/2 | 1707/4 | 1707/6 | - | - | 1707/10 | 1707/11 | 1707/12 | - |
| | Bark effect Cortecchia | 1710/3 | 1710/4 | 1710/8 | - | - | 1710/8 | 1710/10 | 1710/12 | - |
| Ø 14 mm | Plain Liscio | 1716/2 | 1716/4 | 1716/6 | - | 1716/8 | - | - | 1716/10 | - |

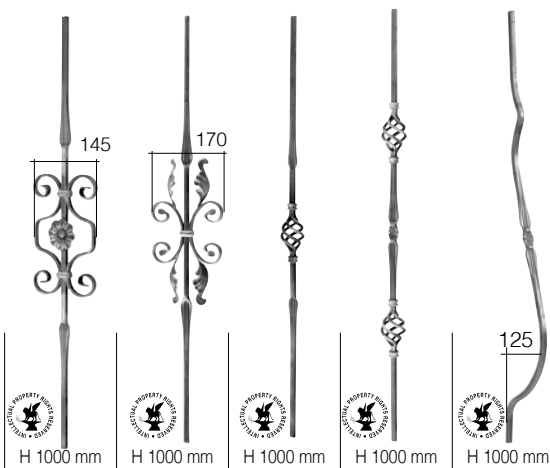

| Sec.Sez. | Finish - Finitura | Art. | Art. | Art. | Art. | Art. |
|----------|------------------------|---------|---------|--------|--------|---------|
| Φ 12 mm | Plain Liscio | 1705/11 | - | 1733/1 | 1733/3 | 1705/13 |
| | Hammered Spigolato | - | - | - | - | 1780/1 |
| | Bark effect Cortecchia | - | - | - | - | 1780/9 |
| Ø 12 mm | Plain Liscio | - | 1716/11 | - | - | 1779/9 |
| Φ 14 mm | Plain Liscio | 1705/12 | - | 1733/2 | 1733/4 | 1705/14 |
| | Hammered Spigolato | - | - | - | - | 1780/2 |
| | Bark effect Cortecchia | - | - | - | - | 1780/10 |
| Ø 14 mm | Plain Liscio | - | 1716/12 | - | - | 1779/10 |

Newel Post - Caposaldo



| Sec.Sez. | Finish - Finitura | Art. |
|----------|------------------------|---------|
| Φ 25 mm | Plain Liscio | 1705/15 |
| | Hammered Spigolato | 1777/9 |
| | Bark effect Cortecchia | 1777/4 |
| Ø 25 mm | Plain Liscio | 1777/1 |

Stamped pickets - Paletti conati

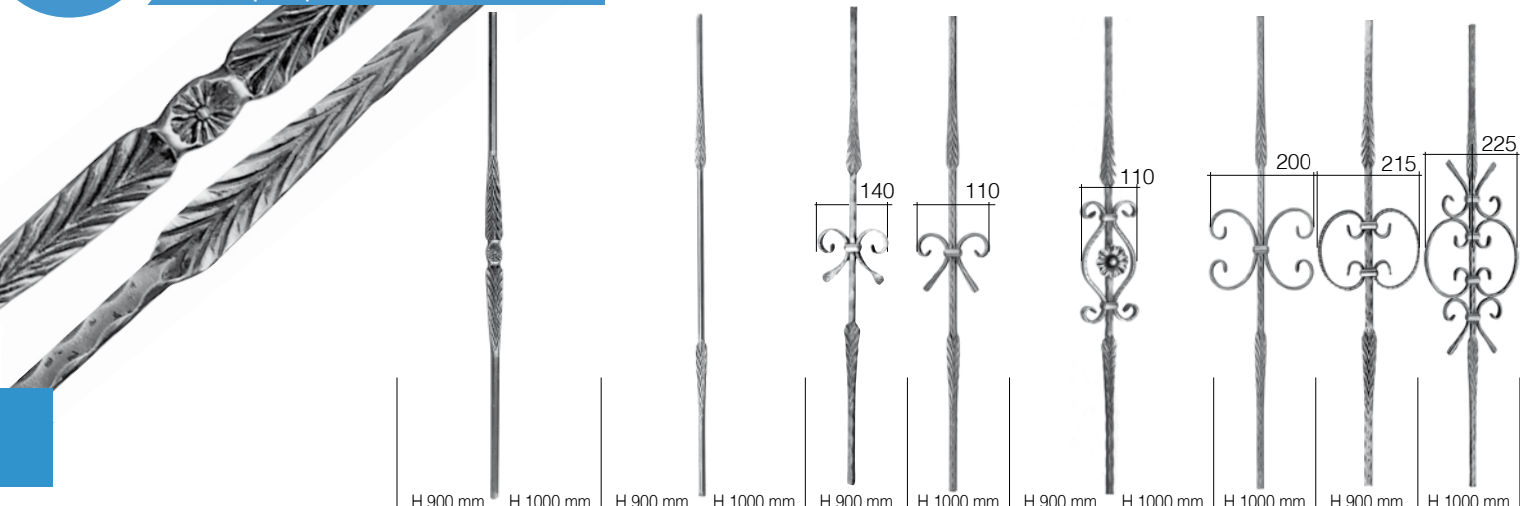

H 900 mm H 1000 mm H 900 mm H 1000 mm H 900 mm H 1000 mm H 900 mm H 1000 mm H 1000 mm H 900 mm H 1000 mm

| Sec.Sez. | Finish - Finitura | Art. | Art. | Art. | Art. | Art. | Art. | Art. | Art. | Art. | Art. | Art. |
|----------|--------------------|--------|--------|--------|--------|--------|--------|--------|--------|--------|-------|--------|
| Φ 12 mm | Plain Liscio | - | - | - | - | - | - | - | - | - | - | - |
| | Hammered Spigolato | 64/F/2 | - | 64/F/4 | - | 64/F/6 | - | 64/F/8 | - | - | 561/1 | - |
| | Diamond Diamantato | - | 1137/1 | - | 1137/3 | - | 1138/3 | - | 1138/1 | 1138/5 | - | 1137/5 |
| Ø 12 mm | Plain Liscio | 573/1 | 573/7 | 573/3 | 573/9 | - | - | - | - | - | - | - |
| Φ 14 mm | Plain Liscio | - | - | - | - | - | - | - | - | - | - | - |
| | Hammered Spigolato | 64/F/3 | - | 64/F/5 | - | 64/F/7 | - | 64/F/9 | - | - | 561/2 | - |
| | Diamond Diamantato | - | 1137/2 | - | 1137/4 | - | 1138/4 | - | 1138/2 | 1138/6 | - | 1137/6 |
| Ø 14 mm | Plain Liscio | 573/2 | 573/8 | 573/4 | 573/10 | - | - | - | - | - | - | - |

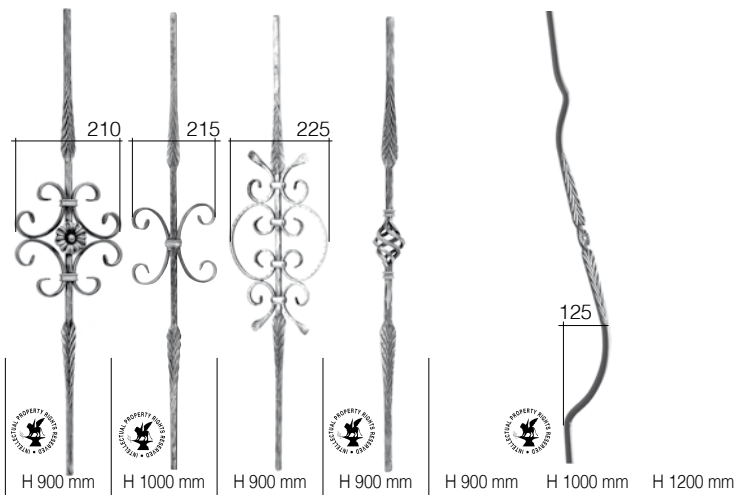

H 900 mm H 1000 mm H 900 mm H 900 mm H 900 mm H 1000 mm H 1200 mm

| Sec.Sez. | Finish - Finitura | Art. | Art. | Art. | Art. | Art. | Art. | Art. |
|----------|--------------------|-------|-------|--------|-------|---------|-----------|---------|
| Φ 12 mm | Plain Liscio | - | - | - | - | - | - | - |
| | Hammered Spigolato | 561/5 | 561/3 | 64/G/1 | 562/1 | 64/H/9 | 64/H/9/S | 64/H/19 |
| | Diamond Diamantato | - | - | - | - | - | 1137/7 | 1137/9 |
| Ø 12 mm | Plain Liscio | - | - | - | - | 572/1 | - | 572/2 |
| Φ 14 mm | Plain Liscio | - | - | - | - | - | - | - |
| | Hammered Spigolato | 561/6 | 561/4 | 64/G/2 | 562/2 | 64/H/10 | 64/H/10/S | 64/H/20 |
| | Diamond Diamantato | - | - | - | - | - | 1137/8 | 1137/10 |
| Ø 14 mm | Plain Liscio | - | - | - | - | 572/3 | - | 572/4 |

Newel Post - Caposaldo

hammered - spigolato

Art. 64/F/1
Φ 25 x 25 mm
H 1200 mm

Newel Post - Caposaldo

plain - liscio

Art. 801/1
Ø 25 mm
H 1200 mm
Art. 801/7
Ø 30 mm
H 1200 mm

Stamped pickets - Paletti conati

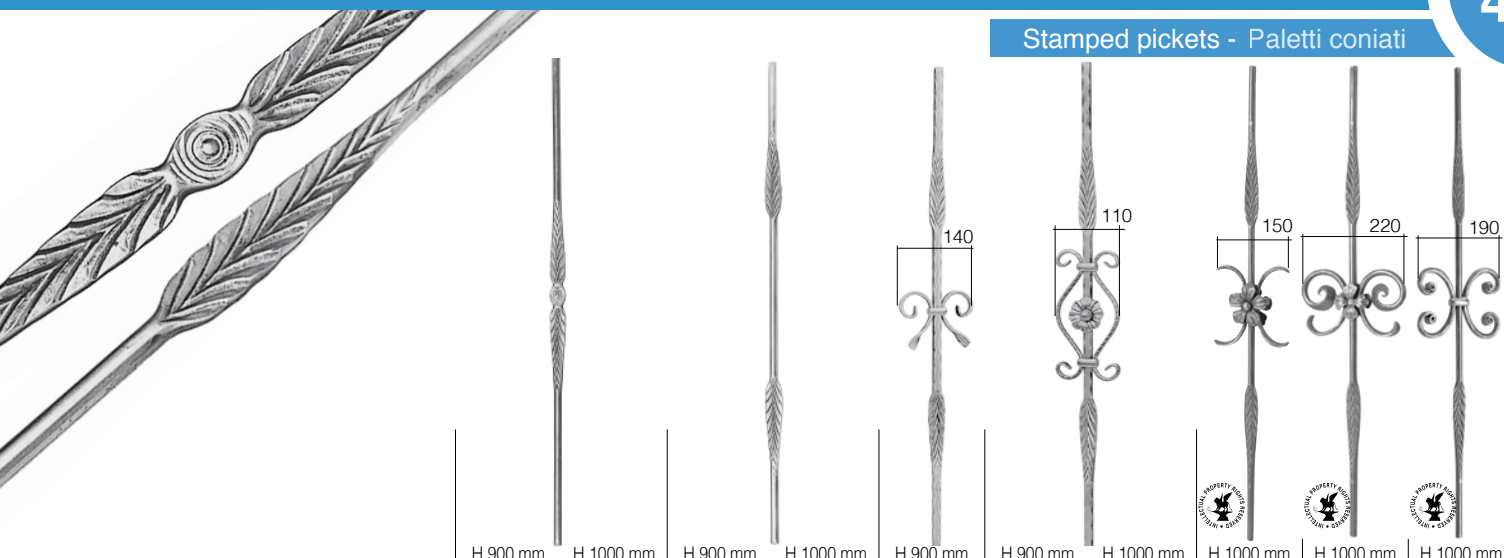

| Sec.Sez. | Finish - Finitura | Art. | Art. | Art. | Art. | Art. | Art. | Art. | Art. | Art. | Art. |
|----------|--------------------|-------|--------|-------|---------|-------|-------|---------|--------|--------|--------|
| Φ 12 mm | Plain Liscio | - | - | - | - | - | - | - | - | - | - |
| | Hammered Spigolato | 578/1 | 1136/5 | 578/3 | 1136/6 | 578/7 | 578/5 | 1138/9 | - | - | - |
| | Diamond Diamantato | - | - | - | - | - | - | - | - | - | - |
| Ø 12 mm | Plain Liscio | 576/1 | 576/5 | 576/3 | 576/6 | - | - | - | - | - | |
| Φ 14 mm | Plain Liscio | - | - | - | - | - | - | - | - | - | - |
| | Hammered Spigolato | 578/2 | 1136/9 | 578/4 | 1136/10 | 578/8 | 578/6 | 1138/10 | - | - | - |
| | Diamond Diamantato | - | - | - | - | - | - | - | - | - | - |
| Ø 14 mm | Plain Liscio | 576/2 | 1135/3 | 576/6 | 1135/4 | - | - | - | 1135/2 | 1135/1 | 1136/1 |

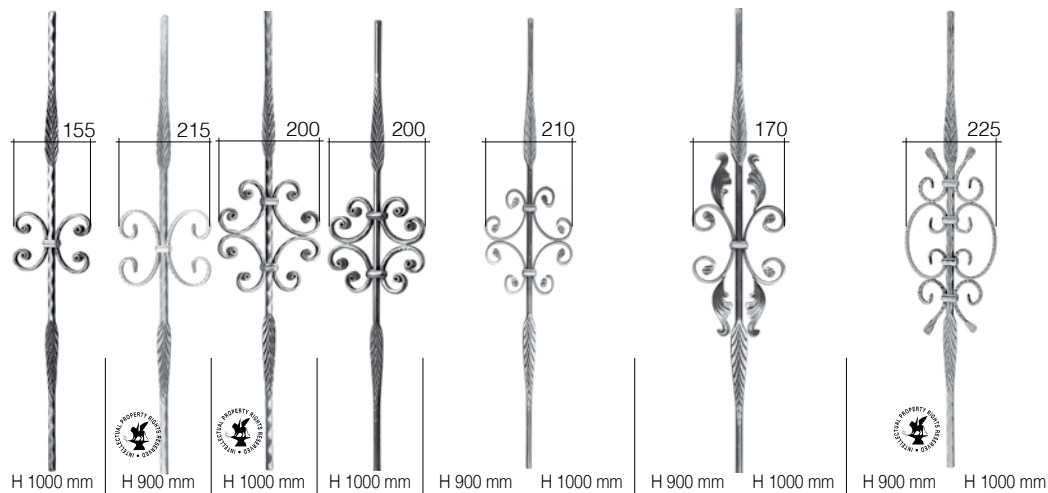

| Sec.Sez. | Finish - Finitura | Art. | Art. | Art. | Art. | Art. | Art. | Art. | Art. | Art. | Art. |
|----------|--------------------|--------|--------|--------|--------|-------|-------|-------|--------|--------|------|
| Φ 12 mm | Plain Liscio | - | - | - | - | - | - | - | - | - | - |
| | Hammered Spigolato | - | 578/11 | 1136/4 | - | - | - | - | - | 578/9 | - |
| | Diamond Diamantato | - | - | 1138/7 | - | - | - | - | - | - | - |
| Ø 12 mm | Plain Liscio | 1136/3 | - | - | - | 577/7 | 577/8 | 577/9 | 577/10 | - | - |
| Φ 14 mm | Plain Liscio | - | - | - | - | - | - | - | - | - | - |
| | Hammered Spigolato | - | 578/12 | 1136/8 | - | - | - | - | - | 578/10 | - |
| | Diamond Diamantato | - | - | 1138/8 | - | - | - | - | - | - | - |
| Ø 14 mm | Plain Liscio | 1136/7 | - | - | 1136/2 | 577/1 | 577/4 | 577/2 | 577/5 | - | - |

Stamped pickets - Paletti conati

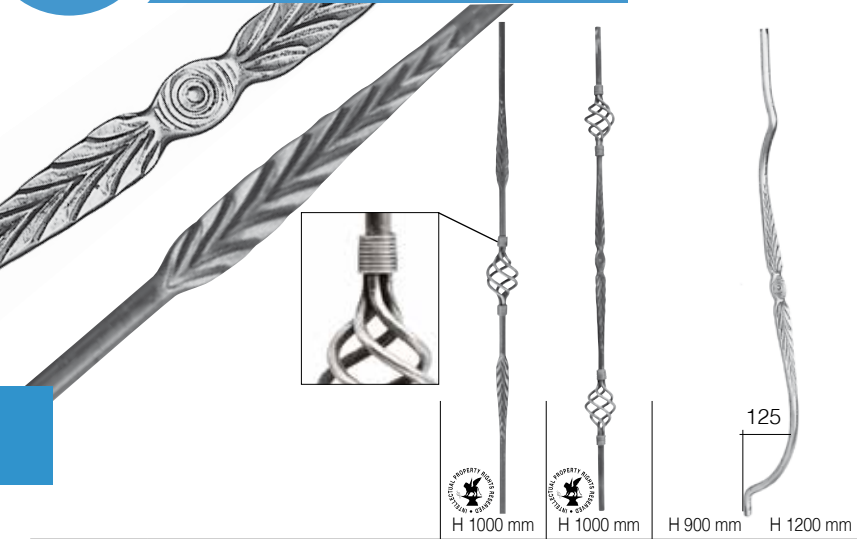

| Sec.Sez. | Finish - Finitura | Art. | Art. | Art. | Art. |
|----------|--------------------|--------|--------|--------|--------|
| Φ 12 mm | Plain Liscio | - | - | - | - |
| | Hammered Spigolato | - | - | 578/17 | 578/18 |
| | Diamond Diamantato | - | - | - | - |
| Ø 12 mm | Plain Liscio | 1734/1 | 1734/2 | 578/13 | 578/14 |
| Φ 14 mm | Plain Liscio | - | - | - | - |
| | Hammered Spigolato | - | - | 578/19 | 578/20 |
| | Diamond Diamantato | - | - | - | - |
| Ø 14 mm | Plain Liscio | - | - | 578/15 | 578/16 |

Newel Post - Caposaldo

| Sec.Sez. | Finish - Finitura | Art. | Art. |
|----------|--------------------|-------|-------|
| Φ 25 mm | Hammered Spigolato | 801/2 | - |
| Ø 25 mm | Plain Liscio | - | 801/5 |
| Ø 30 mm | Plain Liscio | - | 801/8 |



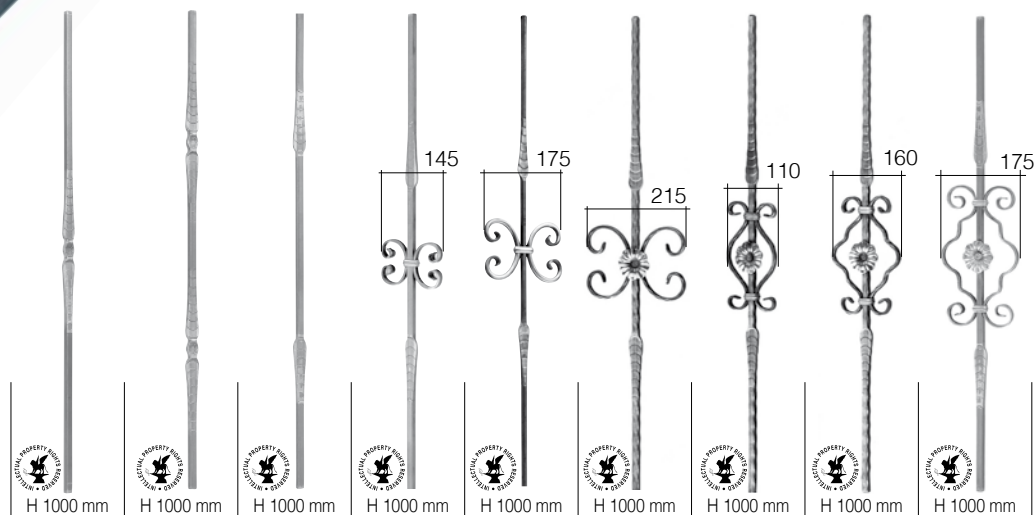

| Sezione | Finish - Finitura | Art. | Art. | Art. | Art. | Art. | Art. | Art. | Art. | Art. |
|---------|------------------------|---------|---------|---------|--------|--------|---------|---------|---------|---------|
| Ø 12 mm | Plain Liscio | 1702/1 | 1702/3 | 1702/5 | 1702/7 | - | - | - | - | 1702/9 |
| | Hammered Spigolato | 1709/13 | 1709/15 | 1709/17 | - | - | 1709/19 | 1709/21 | 1709/23 | - |
| | Bark effect Cortecchia | 1713/1 | 1713/3 | 1713/5 | - | - | 1713/7 | 1713/9 | 1713/11 | - |
| Ø 12 mm | Plain Liscio | 1714/1 | 1714/3 | 1714/5 | - | 1714/7 | - | - | 1714/9 | - |
| | Hammered Spigolato | 1709/14 | 1709/16 | 1709/18 | - | - | 1709/20 | 1709/22 | 1709/24 | - |
| Ø 14 mm | Plain Liscio | 1702/2 | 1702/4 | 1702/6 | 1702/8 | - | - | - | - | 1702/10 |
| | Hammered Spigolato | 1709/14 | 1709/16 | 1709/18 | - | - | 1709/20 | 1709/22 | 1709/24 | - |
| | Bark effect Cortecchia | 1713/2 | 1713/4 | 1713/6 | - | - | 1713/8 | 1713/10 | 1713/12 | - |
| Ø 14 mm | Plain Liscio | 1714/2 | 1714/4 | 1714/6 | - | 1714/8 | - | - | 1714/10 | - |

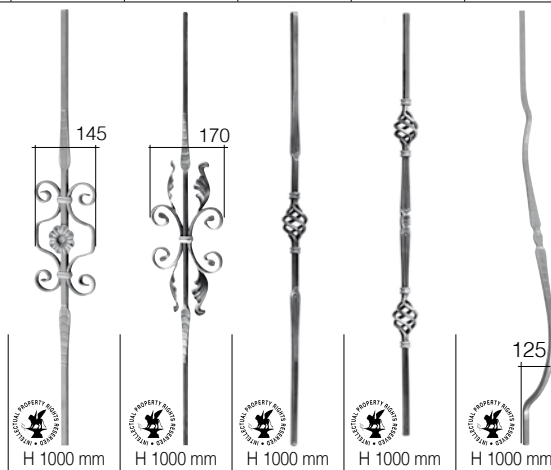

| Sezione | Finish - Finitura | Art. | Art. | Art. | Art. | Art. |
|---------|------------------------|---------|---------|--------|--------|---------|
| Ø 12 mm | Plain Liscio | 1702/11 | - | 1733/5 | 1733/7 | 1702/13 |
| | Hammered Spigolato | - | - | - | - | 1780/3 |
| | Bark effect Cortecchia | - | - | - | - | 1780/11 |
| Ø 12 mm | Plain Liscio | - | 1714/11 | - | - | 1779/11 |
| Ø 14 mm | Plain Liscio | 1702/12 | - | 1733/6 | 1733/8 | 1702/14 |
| | Hammered Spigolato | - | - | - | - | 1780/4 |
| | Bark effect Cortecchia | - | - | - | - | 1780/12 |
| Ø 14 mm | Plain Liscio | - | 1714/12 | - | - | 1779/12 |

Newel Post - Caposaldo

| | | |
|---------|------------------------|---------|
| Ø 25 mm | Plain Liscio | 1702/15 |
| | Hammered Spigolato | 1777/8 |
| | Bark effect Cortecchia | 1777/5 |
| Ø 25 mm | Plain Liscio | 1777/3 |

Stamped pickets - Paletti conati

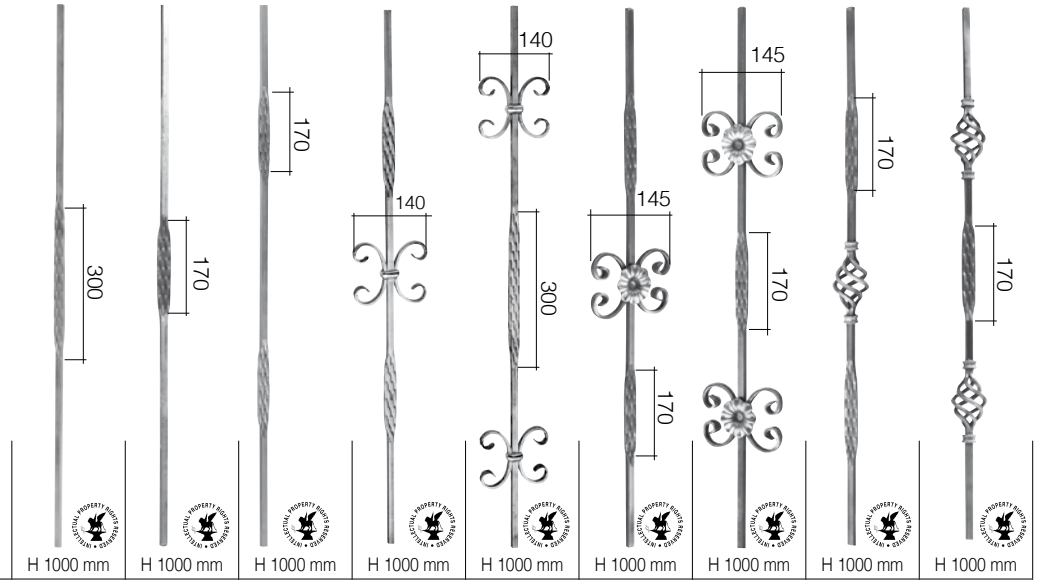
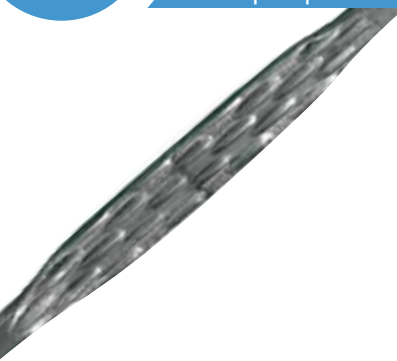

| Sec.Sez. | Finish - Finitura | Art. | Art. | Art. | Art. | Art. | Art. | Art. | Art. | Art. |
|----------|-------------------|--------|---------|--------|--------|--------|--------|--------|--------|--------|
| 12 mm | Plain Liscio | 1727/1 | 1729/11 | 1727/3 | 1727/5 | 1727/7 | 1729/7 | 1729/5 | 1729/3 | 1729/1 |
| Φ 14 mm | Plain Liscio | 1727/2 | 1729/12 | 1727/4 | 1727/6 | 1727/8 | 1729/8 | 1729/6 | 1729/4 | 1729/2 |

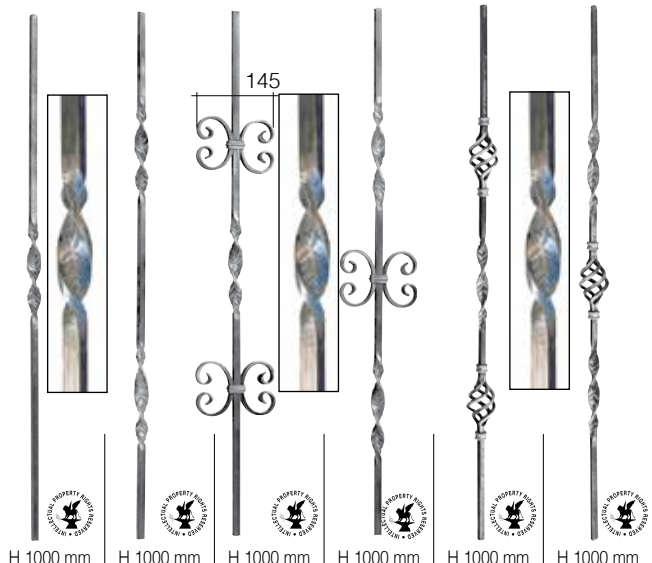

| Sec.Sez. | Finish - Finitura | Art. | Art. | Art. | Art. | Art. | Art. |
|----------|-------------------|---------|---------|---------|---------|---------|---------|
| Φ 12 mm | Plain Liscio | 1730/11 | 1730/9 | 1730/13 | 1730/15 | 1733/15 | 1733/13 |
| Φ 14 mm | Plain Liscio | 1730/12 | 1730/10 | 1730/14 | 1730/16 | 1733/16 | 1733/14 |

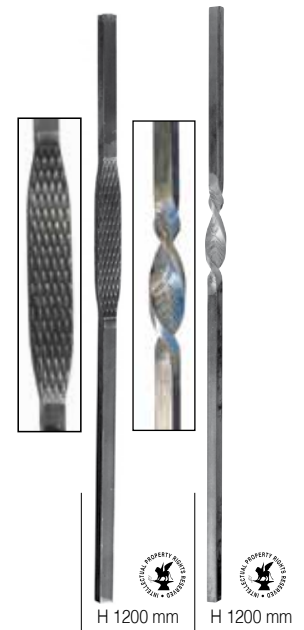

Newel Post - Caposaldo





| Sec.Sez. | Finish - Finitura | Art. | Art. |
|----------|-------------------|--------|---------|
| Φ 20 mm | Plain Liscio | 1775/7 | - |
| Φ 25 mm | Plain Liscio | 1775/8 | 1730/17 |
| Φ 30 mm | Plain Liscio | 1777/9 | - |

Stamped pickets - Paletti conati





| Sec.Sez. | Finish - Finitura | Art. | Art. |
|----------|--|--------|--------|
| ∅ 12 mm | Plain Liscio  | 1730/3 | 1730/1 |
| ∅ 14 mm | Plain Liscio  | 1730/4 | 1730/2 |



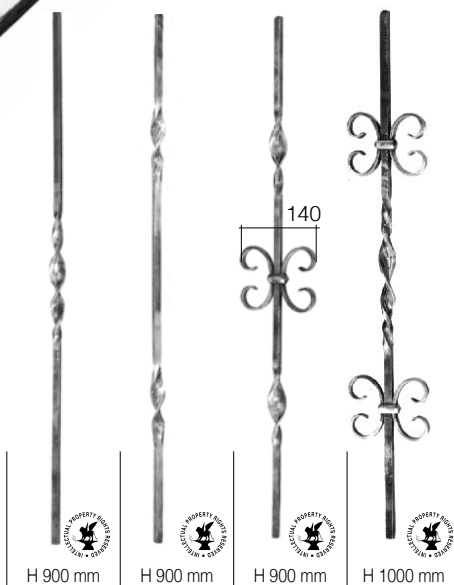

| Sec.Sez. | Finish - Finitura | Art. | Art. |
|----------|--|--------|--------|
| ∅ 12 mm | Plain Liscio  | 1730/7 | 1730/5 |
| ∅ 14 mm | Plain Liscio  | 1730/8 | 1730/6 |



| Sec.Sez. | Finish - Finitura | Art. | Art. | Art. | Art. |
|----------|--|-------|-------|-------|-------|
| ∅ 12 mm | Plain Liscio  | 50/5 | 50/6 | 50/7 | 50/8 |
| ∅ 14 mm | Plain Liscio  | 50/9 | 50/10 | 50/11 | 50/12 |
| ∅ 16 mm | Plain Liscio  | 50/13 | 50/14 | 50/15 | 50/16 |

Newel Post - Caposaldo



| Sec.Sez. | Finish - Finitura | Art. |
|----------|--|-------|
| ∅ 20 mm | Plain Liscio  | 113/5 |
| ∅ 30 mm | Plain Liscio  | 113/6 |

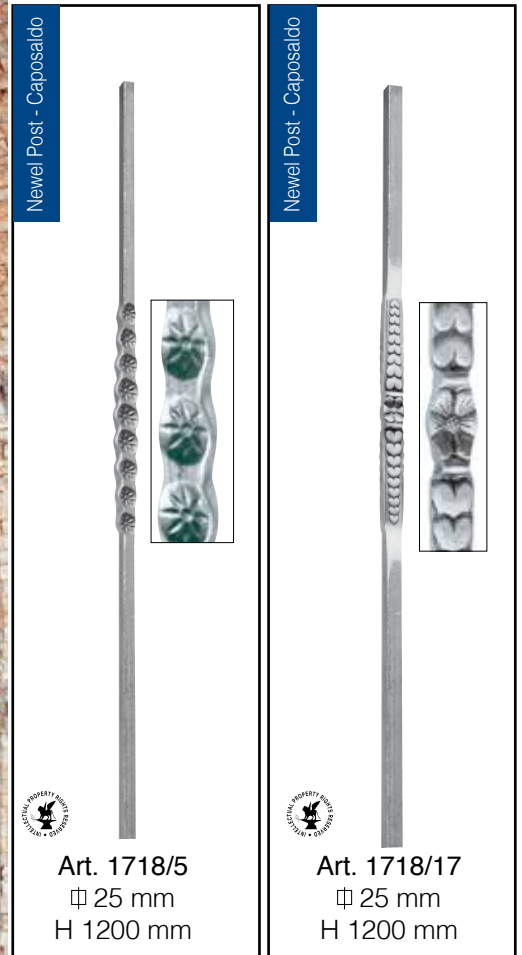

Stamped pickets - Paletti conati



| Sec.Sez. | Finish - Finitura | Bush - Borchia | Art. | Art. |
|----------|--------------------------|--|----------|----------|
| Φ 12 mm | Plain Liscio | 1393/19 | 1746/1 | 1746/2 |
| | Hammered Spigolato | | 1746/3 | 1746/4 |
| | Bark effect Corteccia | | 1746/5 | 1746/6 |
| | Plain Liscio | 1391/21 cast steel bush borchia ferro fuso | 1176/1/S | 1176/2/S |
| | Bark effect Corteccia | | 1176/3/S | 1176/4/S |
| Ø 12 mm | Plain Liscio | 1466/4 1466/5 brass - ottone | 1179/1 | 1179/2 |
| | Plain Liscio | | GD275/1 | GD275/7 |
| | Plain Liscio | 739/1 | 1177/1 | 1177/2 |
| | Plain Liscio | 1393/27/S | 1177/5 | 1177/6 |
| | Plain Liscio | 1394/22 hollow sphere sfera vuota | 1177/9 | 1177/10 |
| Ø 14 mm | Plain Liscio | 1466/14 lathed bush borchia tornita | GD275/1 | GD275/7 |
| | Plain Liscio | 739/1 | 1177/3 | 1177/4 |
| | Plain Liscio | 1393/28/S | 1177/7 | 1177/8 |
| | Plain Liscio | 1466/13 lathed bush borchia tornita | GD275/3 | GD275/9 |
| | Plain Liscio | 1466/15 lathed bush borchia tornita | GD275/2 | GD275/8 |
| | Plain Liscio | 1466/4 1466/5 brass - ottone | 1179/3 | 1179/4 |

Newel Post - Caposaldo

Art. 64/I/1
Φ 25 x 25 mm
H 1200 mm

Newel Post - Caposaldo

hollow sphere
sfera vuota
1394/12/S

Art. 1205/2
Ø 25 mm
H 1200 mm

Newel Post - Caposaldo

128/C/5

Art. 1205/1
Ø 25 mm
H 1200 mm



PLAIN PICKETS - PALETTI LISCI
TUBE-TUBO Ø 30 mm THICKN. - SPESS. 1,5 mm



Art. 148/2
 Ø 30 mm
 H 900 mm



Art. 148/1
 Ø 30 mm
 H 900 mm



Art. 149/1
 Ø 30 mm
 H 900 mm



Art. 149/2
 Ø 30 mm
 H 900 mm



Art. 537/8
 Ø 30 mm
 H 1000 mm



Art. 537/9
 Ø 30 mm
 H 1000 mm



GROOVED PICKETS - PALETTI RIGATI
TUBE-TUBO Ø 30 mm THICKN. - SPESS. 1,5 mm



Art. 1231/1
 Ø 30 mm
 H 1000 mm



Art. 1229/1
 Ø 30 mm
 H 1000 mm



Art. 1231/2
 Ø 30 mm
 H 1000 mm



Art. 1229/2
 Ø 30 mm
 H 1000 mm



Art. 1229/4
 Ø 30 mm
 H 1000 mm



Art. 1229/5
 Ø 30 mm
 H 1000 mm

Some Arteferro tubular pickets appear in the film "007 GoldenEye" (1995) directed by Martin Campbell

Alcuni paletti in tubo Arteferro appaiono nel film "007 GoldenEye" (1995) diretto da Martin Campbell



Art. 1794/10
 Ø 30 x 1,5 mm
 L 3000 mm

Art. 1794/10/6000
 Ø 30 x 1,5 mm
 L 6000 mm

PLAIN PICKETS - PALETTI LISCI

Tube pickets - Paletti in tubo

TUBE - TUBO Ø 30 mm THICKN. - SPESS. 1,5 mm

TUBE - TUBO Ø 40 mm THICKN. - SPESS. 2 mm



Art. 537/2
Ø 30 mm
H 1000 mm



Art. 537/1
Ø 30 mm
H 1000 mm



Art. 537/3
Ø 30 mm
H 1000 mm



Art. 146/1
Ø 40 mm
H 900 mm



Art. 146/4
Ø 40 mm
H 900 mm



Newel Post - Caposaldo

Brass Ottone

Art. 160/42

Art. 145/3
Ø 40 mm
H 1000 mm



Brass Ottone

Art. 160/42

Art. 145/4
Ø 40 mm
H 1200 mm

GROOVED PICKETS - PALETTI RIGATI

TUBE-TUBO Ø 30 mm THICKN. - SPESS. 1,5 mm

TUBE-TUBO Ø 40 mm THICKN. - SPESS. 2 mm



Art. 1230/2
Ø 30 mm
H 1000 mm



Art. 1230/4
Ø 30 mm
H 1000 mm



Art. 1229/3
Ø 30 mm
H 1000 mm



Art. 1794/3
Ø 40 mm
H 1000 mm



Art. 1794/4
Ø 40 mm
H 1000 mm



Newel Post - Caposaldo

Brass Ottone

Art. 160/42

Art. 1794/5
Ø 40 mm
H 1000 mm



Newel Post - Caposaldo

Brass Ottone

Art. 160/42

Art. 1794/6
Ø 40 mm
H 1200 mm



Art. 1794/9
Ø 40 x 2 mm
L 3000 mm
Art. 1794/9/6000
Ø 40 x 2 mm
L 6000 mm

Pickets with twisting - Paletti con torciglione

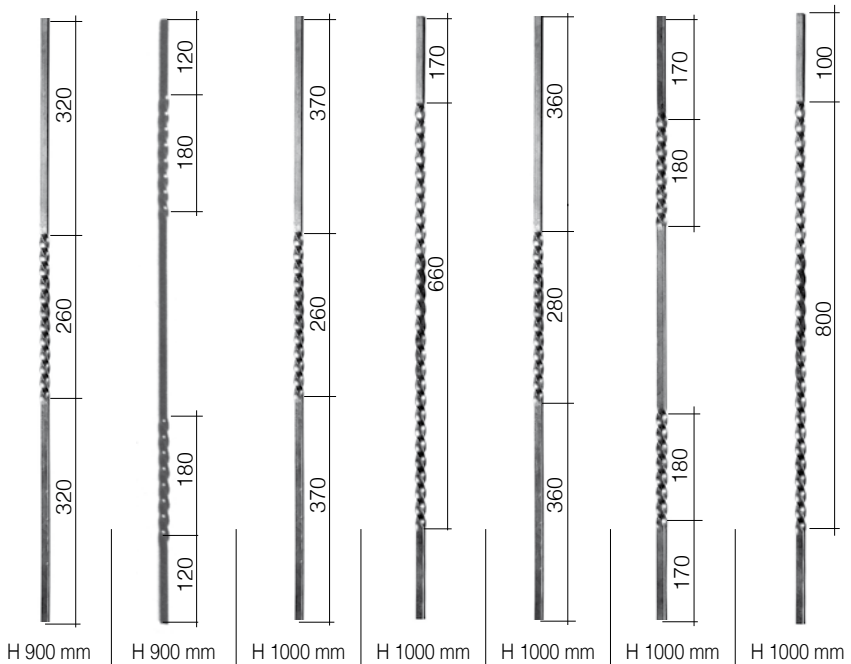

| Sec.Sez. | Finish - Finitura | Art. | Art. | Art. | Art. | Art. | Art. | Art. |
|----------|-----------------------|---------|---------|----------|---------|---------|---------|--------|
| Φ 12 mm | Plain Liscio | 65/8 | 53/3 | - | 1148/2 | 1148/5 | 1148/8 | - |
| | Bark effect Corteccia | - | - | - | 1148/11 | 1148/14 | 1148/17 | - |
| | Grooved Rigato | 118/H/2 | 118/H/1 | 118/H/30 | 1151/7 | 1151/5 | 1151/6 | 1723/3 |
| Φ 14 mm | Plain Liscio | 70/D/3 | 70/D/2 | - | 1148/3 | 1148/6 | 1148/9 | - |
| | Bark effect Corteccia | - | - | - | 1148/12 | 1148/15 | 1148/18 | - |
| | Grooved Rigato | - | - | - | - | - | - | 1723/4 |



| Section Sezione | Finish - Finitura | H 720 mm A = 520 mm | H 820 mm A = 620 mm | H 900 mm A = 700 mm | H 1200 mm A = 900 mm |
|-----------------|-------------------|------------------------|------------------------|------------------------|-------------------------|
| | | Art. | Art. | Art. | Art. |
| ∅ 16 x 4 mm | Plain Liscio | 119/4 | 119/11 | 119/18 | - |
| ∅ 20 x 4 mm | | 119/5 | 119/12 | 119/19 | - |
| ∅ 20 x 6 mm | | 119/6 | 119/13 | 119/20 | - |
| ∅ 30 x 8 mm | | - | - | 118/H/3 | 118/H/4 |



| Section Sezione | Finish - Finitura | H 720 mm A = 520 mm | H 820 mm A = 620 mm | H 900 mm A = 700 mm |
|-----------------|-------------------|------------------------|------------------------|------------------------|
| | | Art. | Art. | Art. |
| Φ 12 x 12 mm | Plain - Plain | 119/9 | 119/16 | 119/23 |
| Φ 14 x 14 mm | | 119/10 | 119/17 | 119/24 |

**TWISTS WITH TRIPLE TWISTING
TORCIGLIONI CON TRIPLA ATTORCIGLIATURA**

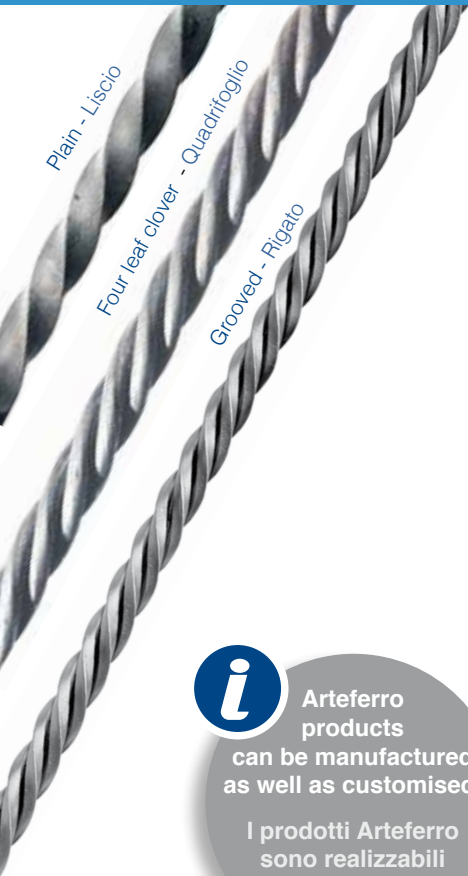

i Arteferro products can be manufactured as well as customised.
I prodotti Arteferro sono realizzabili anche su misura.



| Sec.Sez. | Finish - Finitura | Art. | H 900 mm Art. | H 1000 mm Art. | H 1200 mm Art. |
|----------|-------------------------------|----------|------------------|-------------------|-------------------|
| Ø 12 mm | Plain Liscio | GD106/1 | GD106/4 | GD106/7 | |
| | Four-leaf clover Quadrifoglio | GD106/10 | GD106/13 | GD106/16 | |
| | Grooved Rigato | GD106/19 | GD106/22 | GD106/25 | |
| Ø 14 mm | Plain Liscio | GD106/2 | GD106/5 | GD106/8 | |
| | Four-leaf clover Quadrifoglio | GD106/11 | GD106/14 | GD106/17 | |
| | Grooved Rigato | GD106/20 | GD106/23 | GD106/26 | |
| Ø 16 mm | Plain Liscio | GD106/3 | GD106/6 | GD106/9 | |
| | Four-leaf clover Quadrifoglio | GD106/12 | GD106/15 | GD106/18 | |
| | Grooved Rigato | GD106/21 | GD106/24 | GD106/27 | |

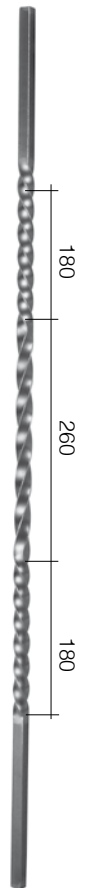

Newel Post - Caposaldo

| Sezione | Finish - Finitura | Art. | Art. | Art. | Art. | Art. |
|---------|-------------------|-------|-------|----------|--------|--------|
| Ø 20 mm | Plain Liscio | - | 113/7 | - | 119/25 | 1751/5 |
| Ø 25 mm | Beveled Smussato | 112/3 | - | - | - | - |
| Ø 30 mm | Beveled Smussato | 112/4 | - | - | - | - |
| Ø 25 mm | Plain Liscio | - | - | GD22/6/S | 119/26 | - |
| Ø 30 mm | Plain Liscio | - | 113/8 | GD22/6 | 119/27 | - |

Pickets with twisting - Paletti con torciglione

Plain - Liscio

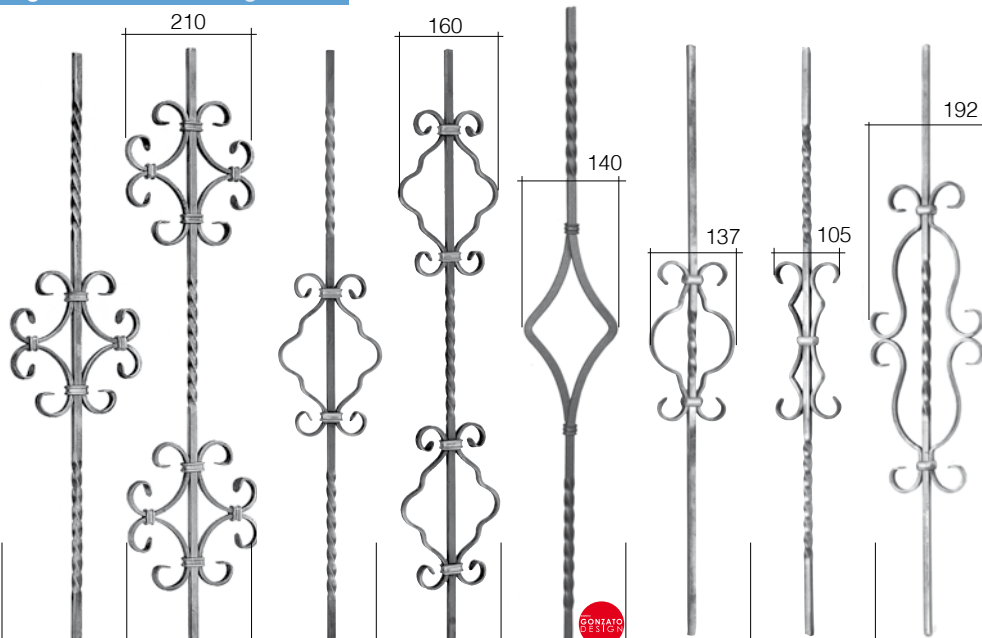

H 900 mm H 900 mm H 1000 mm H 1000 mm H 1000 mm H 900 mm H 900 mm H 900 mm

| Sec.Sez. | Finish - Finitura | Art. | Art. | Art. | Art. | Art. | Art. | Art. | Art. |
|----------|--|-------|-------|--------|--------|---------|--------|--------|--------|
| ∅ 12 mm | Plain Liscio  | 584/1 | 584/2 | 1127/1 | 1127/2 | GD275/5 | 64/E/1 | 64/E/2 | 64/E/3 |



Pag. 36



Large choice of twisted bars 3m long

Ampia scelta di barre attorcigliate 3 mt.

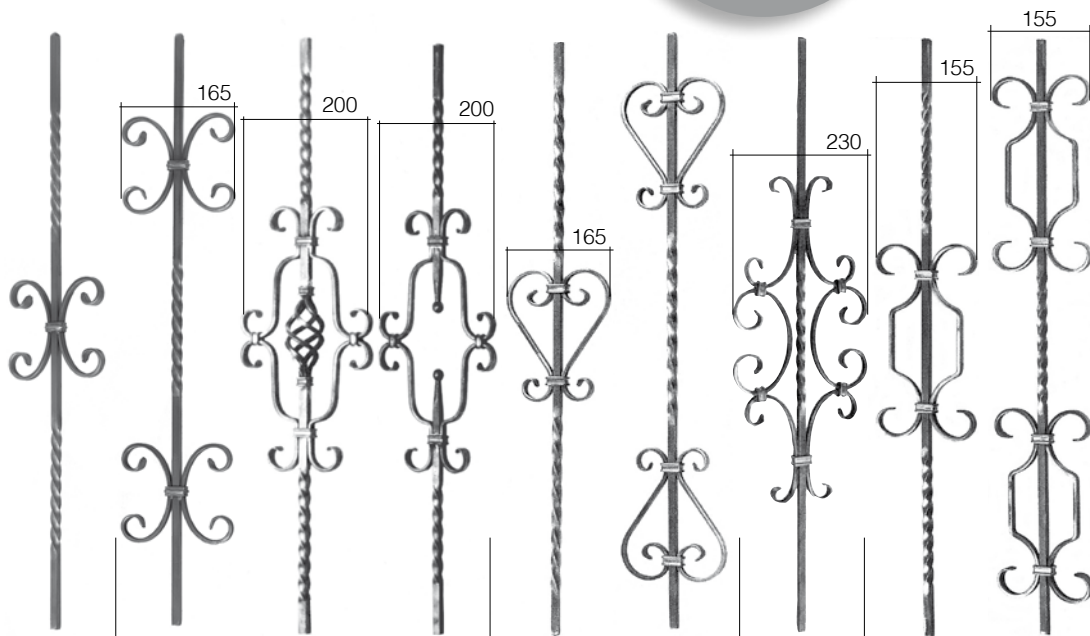
Plain - Liscio



H 900 mm H 900 mm H 900 mm H 900 mm H 900 mm H 900 mm H 900 mm H 900 mm H 900 mm

| Sec.Sez. | Finish - Finitura | Art. | Art. | Art. | Art. | Art. | Art. | Art. | Art. | Art. |
|----------|--|-------|-------|--------|--------|---------|---------|---------|---------|---------|
| ∅ 12 mm | Plain Liscio  | 584/4 | 584/5 | 64/B/2 | 64/A/3 | 584/B/2 | 584/B/1 | 584/A/6 | 584/A/5 | 584/A/4 |
| ∅ 14 mm | Plain Liscio  | - | - | 64/B/5 | 64/A/7 | - | - | - | - | - |

Pickets with twisting - Paletti con torciglione

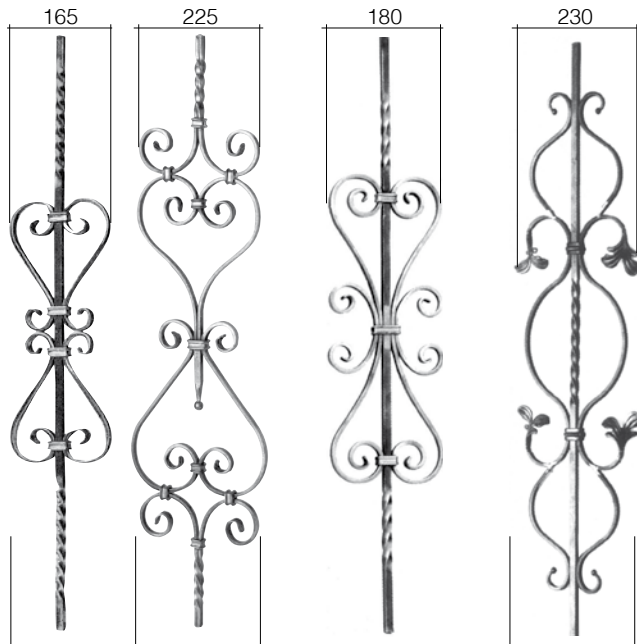

H 900 mm H 1000 mm H 900 mm H 1000 mm H 1000 mm

| Sec.Sez. | Finish - Finitura | Art. | Art. | Art. | Art. | Art. |
|----------|--|---------|--------|------|--------|--------|
| Φ 12 mm | Plain Liscio  | 584/B/3 | 1124/1 | 49/3 | 1753/1 | 52/A/2 |

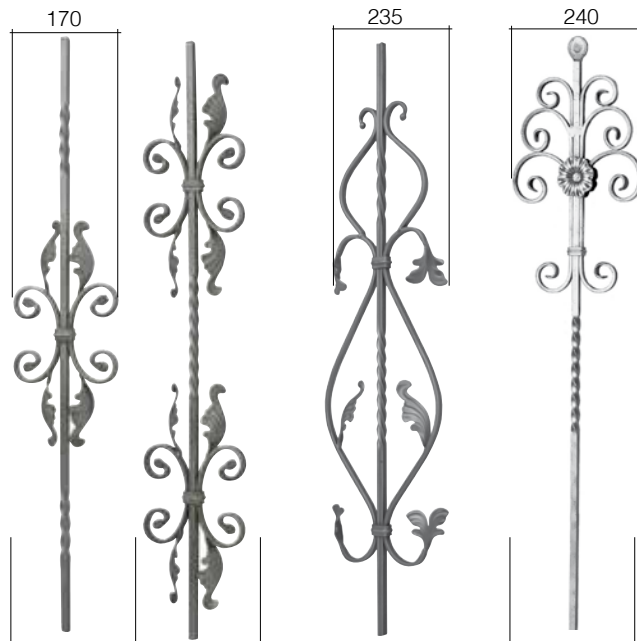

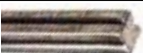

H 900 mm H 900 mm H 900 mm H 1000 mm H 1000 mm

| Sec.Sez. | Finish - Finitura | Art. | Art. | Art. | Art. | Art. |
|----------|--|--------|--------|------|--------|--------|
| Φ 12 mm | Plain Liscio  | 52/A/3 | 52/A/5 | - | - | 1124/2 |
| Φ 12 mm | Grooved Rigato  | - | - | 52/2 | 1753/7 | - |

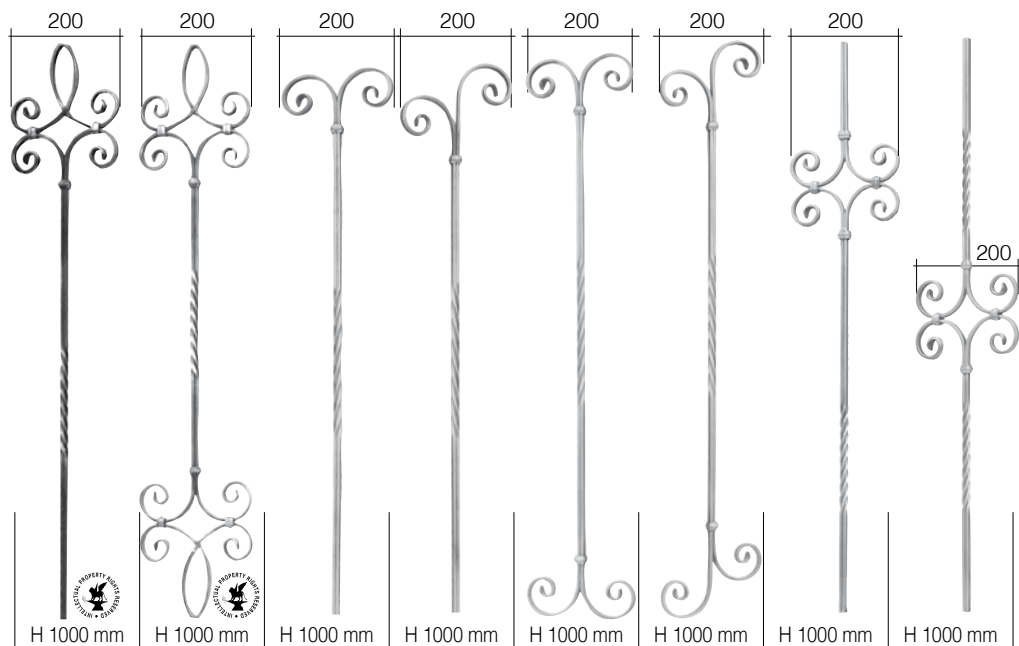

Grooved - Rigato



| Sec.Sez. | Finish - Finitura | Art. | Art. | Art. | Art. | Art. | Art. | Art. | Art. |
|----------|--|--------|--------|--------|--------|--------|--------|--------|--------|
| ∅ 12 mm | Grooved Rigato  | 1688/4 | 1688/3 | 1695/1 | 1695/2 | 1695/3 | 1695/4 | 1695/5 | 1695/6 |



Pickets with twisting - Paletti con torciglione

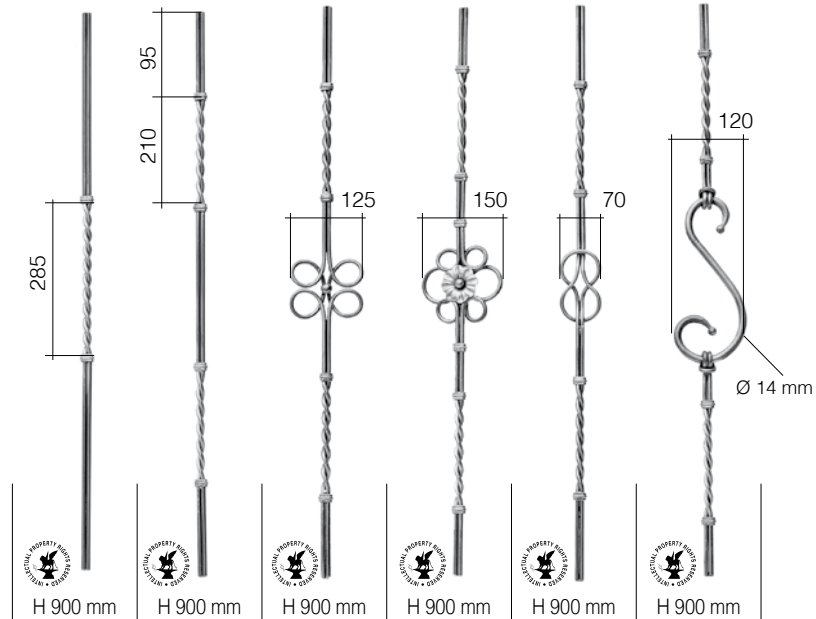
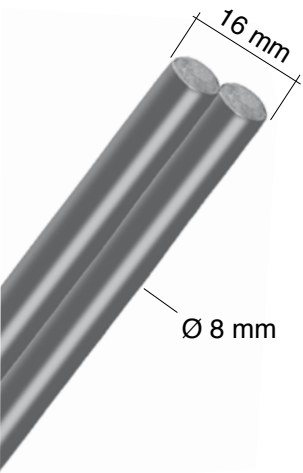

| Sec.Sez. | Finish - Finitura | Art. | Art. | Art. | Art. | Art. | Art. |
|----------|-------------------|-------|-------|-------|-------|-------|-------|
| Ø 8 mm | Plain Liscio | 617/7 | 617/6 | 615/3 | 615/1 | 615/4 | 617/5 |

BEST PRICE

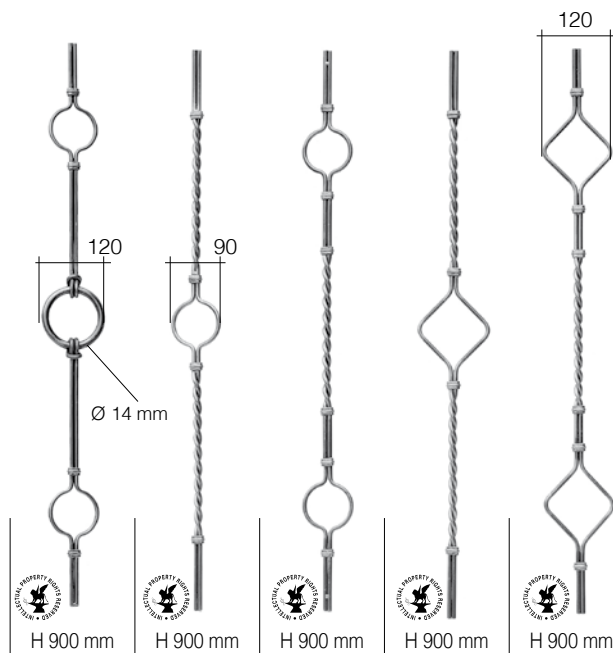
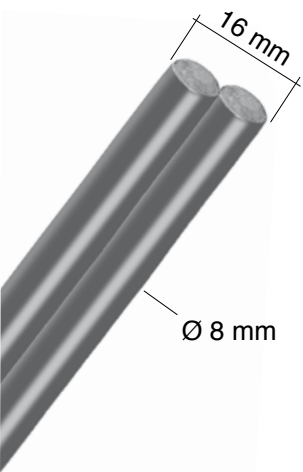

| Sec.Sez. | Finish - Finitura | Art. | Art. | Art. | Art. | Art. |
|----------|-------------------|-------|-------|-------|-------|-------|
| Ø 8 mm | Plain Liscio | 615/2 | 617/1 | 617/2 | 617/3 | 617/4 |



Not all of the Arterferro items are available in Arterferro Quick, just a special selection. Find out about the entire range in the catalogue

In Arterferro Quick non sono presenti tutti gli articoli Arterferro, ma solo una speciale selezione. Scopri la gamma completa nel catalogo

Compendium

Pickets with big twisting - Paletti con torciglione grande

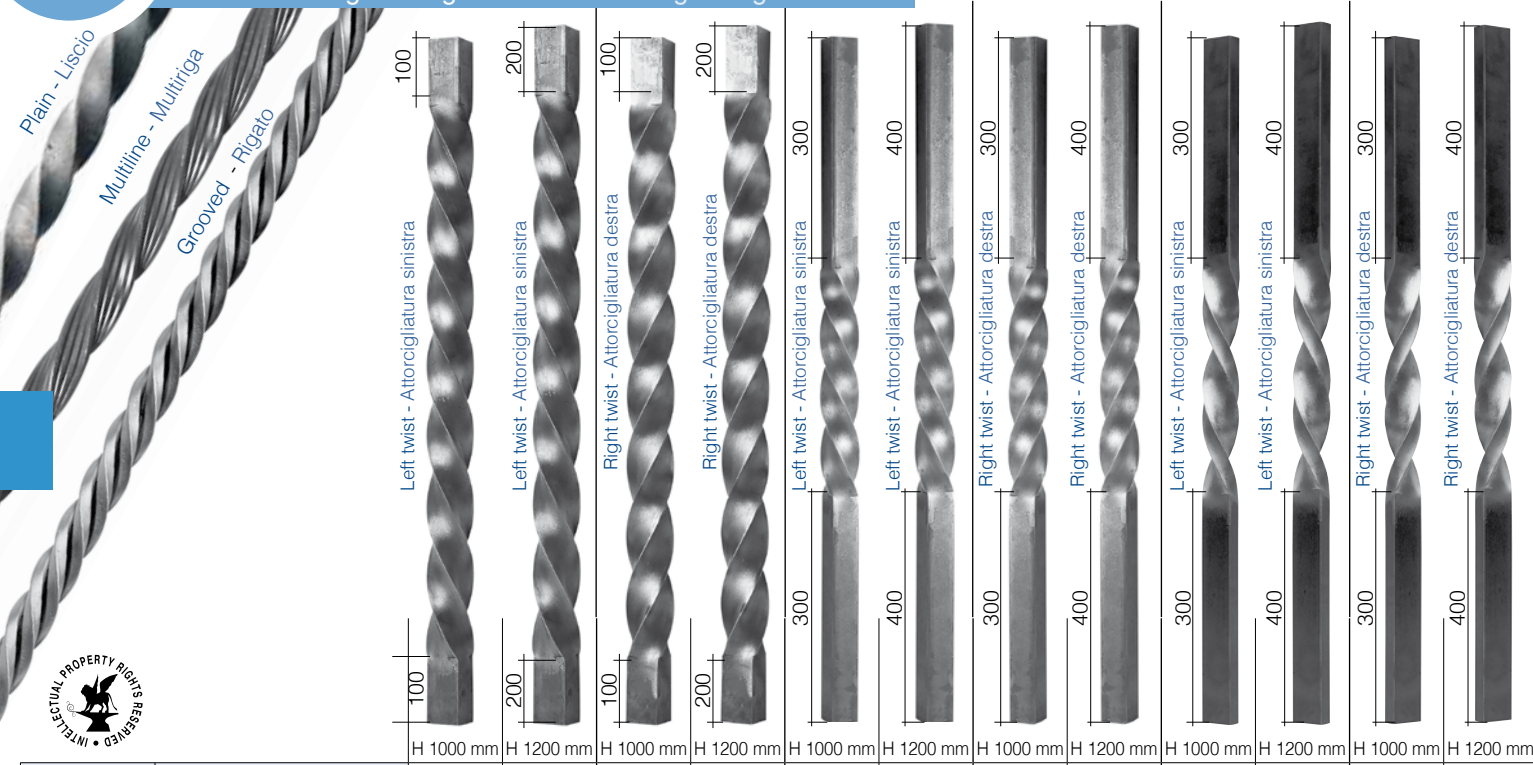

| Sec.Sez. | Finish - Finitura | Art. | Art. | Art. | Art. | Art. | Art. | Art. | Art. | Art. | Art. | Art. | Art. |
|--------------|---------------------|---------|---------|---------|---------|---------|---------|---------|---------|---------|---------|---------|---------|
| Ø 30 mm | Plain Liscio | 119/27 | 1724/20 | 1724/25 | 1724/26 | 1724/31 | 1724/32 | 1724/37 | 1724/38 | - | - | - | - |
| | Multiline Multiriga | 1725/5 | 1725/6 | 1725/11 | 1725/12 | 1725/17 | 1725/18 | 1725/23 | 1725/24 | - | - | - | - |
| | Grooved Rigato | 1724/43 | 1724/44 | 1724/49 | 1724/50 | 1724/55 | 1724/56 | 1724/61 | 1724/62 | - | - | - | - |
| Ø 40 mm | Plain Liscio | 119/28 | 1724/19 | 1724/23 | 1724/24 | 1724/29 | 1724/30 | 1724/35 | 1724/36 | - | - | - | - |
| | Multiline Multiriga | 1725/3 | 1725/4 | 1725/9 | 1725/10 | 1725/15 | 1725/16 | 1725/21 | 1725/22 | - | - | - | - |
| | Grooved Rigato | 1724/41 | 1724/42 | 1724/47 | 1724/48 | 1724/53 | 1724/54 | 1724/59 | 1724/60 | - | - | - | - |
| Ø 50 mm | Plain Liscio | 1724/17 | 1724/18 | 1724/21 | 1724/22 | 1724/27 | 1724/28 | 1724/33 | 1724/34 | - | - | - | - |
| | Multiline Multiriga | 1725/1 | 1725/2 | 1725/7 | 1725/8 | 1725/13 | 1725/14 | 1725/19 | 1725/20 | - | - | - | - |
| | Grooved Rigato | 1724/39 | 1724/40 | 1724/45 | 1724/46 | 1724/51 | 1724/52 | 1724/57 | 1724/58 | - | - | - | - |
| Ø 50 x 25 mm | Plain Liscio | 1724/3 | 1724/4 | 1724/7 | 1724/8 | - | - | - | - | 1724/11 | 1724/12 | 1724/15 | 1724/16 |
| Ø 60 x 30 mm | Plain Liscio | 1724/1 | 1724/2 | 1724/5 | 1724/6 | - | - | - | - | 1724/9 | 1724/10 | 1724/13 | 1724/14 |





Pickets with baskets - Paletti con pigna



159/3 \varnothing 12 mm
 159/4 \varnothing 14 mm
 159/5 \varnothing 16 mm

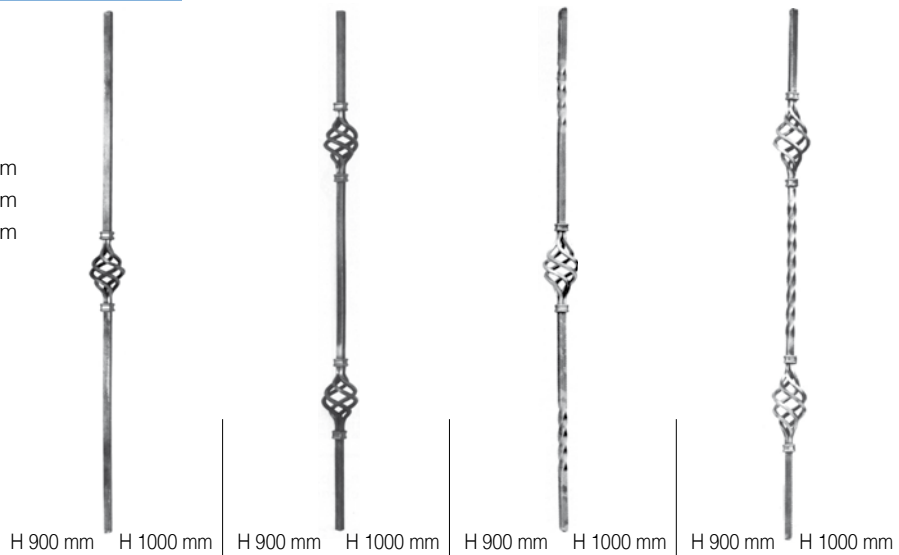



| Sec.Sez. | Finish - Finitura | H 900 mm | | H 1000 mm | | H 900 mm | | H 1000 mm | |
|---------------------|---|----------|---------|-----------|---------|----------|--------|-----------|--------|
| | | Art. | Art. | Art. | Art. | Art. | Art. | Art. | Art. |
| \varnothing 12 mm | Plain Liscio  | 48/A/2 | - | 48/A/1 | - | 48/2 | - | 48/1 | - |
| | Hammered Spigolato  | 48/4 | - | 48/3 | - | - | - | - | - |
| | Hammered Martellato  | 48/A/4 | - | 48/A/3 | - | - | - | - | - |
| | Grooved Rigato  | - | 1151/3 | - | 1151/4 | - | 1151/1 | - | 1151/2 |
| | Bark effect Corteccia  | - | 1733/18 | - | 1733/17 | - | - | - | - |
| \varnothing 14 mm | Plain Liscio  | - | - | 48/A/5 | - | 48/7 | - | 48/6 | - |
| | Hammered Spigolato  | 48/9 | - | 48/8 | - | - | - | - | - |
| | Hammered Martellato  | 48/A/8 | - | 48/A/7 | - | - | - | - | - |
| | Bark effect Corteccia  | - | 1733/20 | - | 1733/19 | - | - | - | - |
| \varnothing 16 mm | Plain Liscio  | - | - | 48/A/9 | - | 48/12 | - | 48/11 | - |
| | Hammered Spigolato  | 48/14 | - | 48/13 | - | - | - | - | - |
| | Hammered Martellato  | 48/A/12 | - | 48/A/11 | - | - | - | - | - |



1466/12

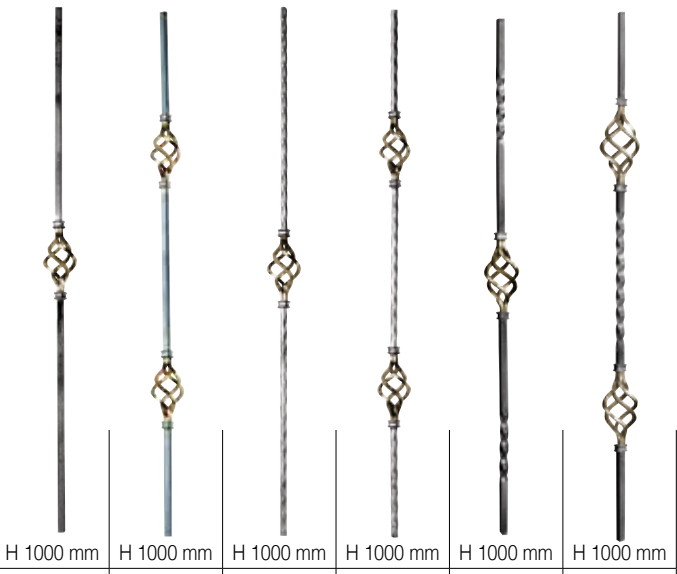

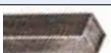
brass-ottone

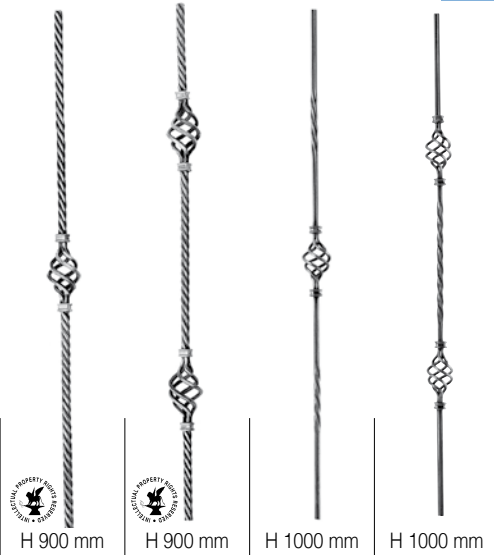

| Sec.Sez. | Finish - Finitura | H 1000 mm | | H 1000 mm | | H 1000 mm | |
|---------------------|--|-----------|--------|-----------|--------|-----------|--------|
| | | Art. | Art. | Art. | Art. | Art. | Art. |
| \varnothing 12 mm | Plain Liscio  | 1149/1 | 1149/2 | - | - | 1149/5 | 1149/6 |
| | Hammered Spigolato  | - | - | 1149/3 | 1149/4 | - | - |

Pickets with baskets - Paletti con pigna





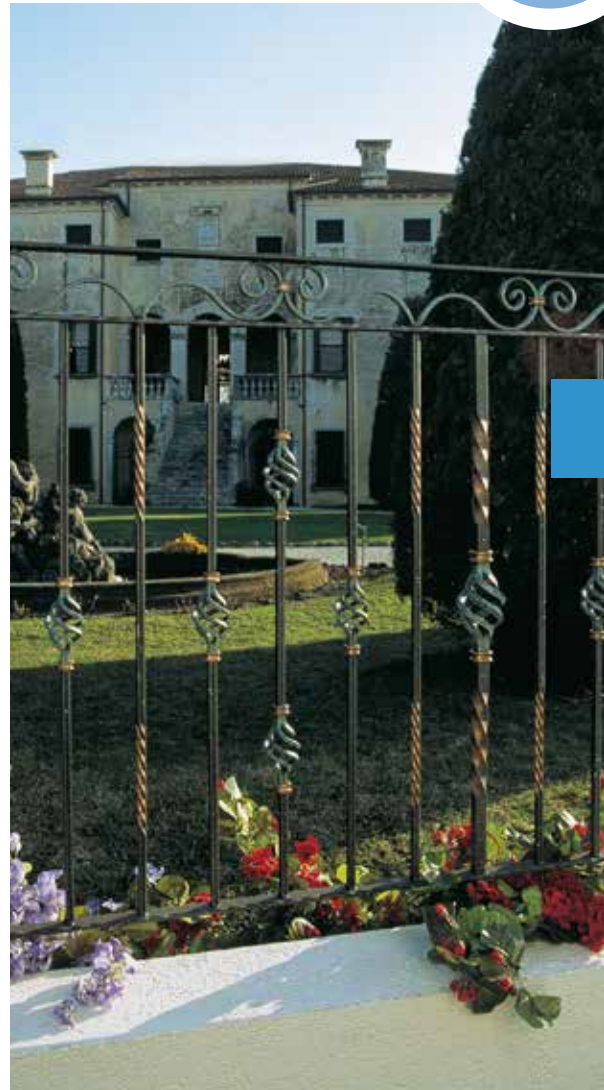

| Sec.Sez. | Finish - Finitura | Art. | Art. | Art. | Art. |
|----------|--|-------|-------|--------|--------|
| ∅ 12 mm | Bark effect Corteccia  | 462/1 | 462/2 | 1150/3 | 1150/4 |
| ∅ 14 mm | Bark effect Corteccia  | - | - | 1150/7 | 1150/8 |

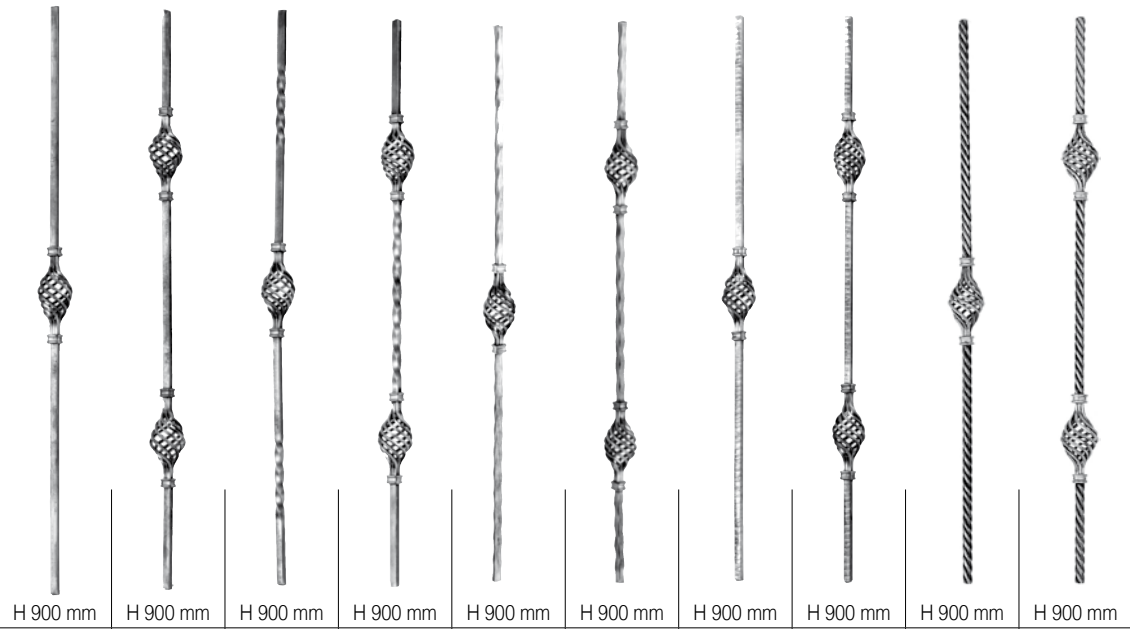
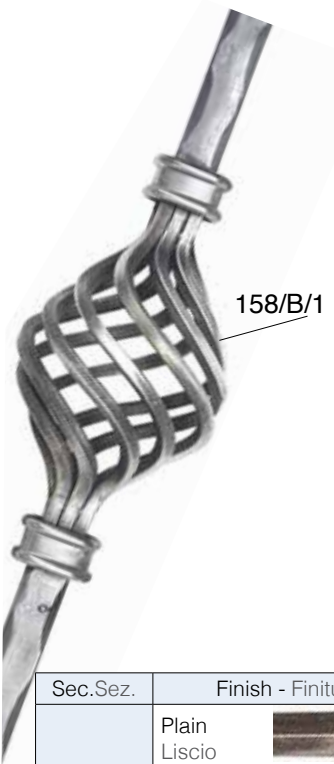







i
Pag. 229 See also the Basket section
Vedi anche il capitolo Pigna







| Sec.Sez. | Finish - Finitura | Art. | Art. | Art. | Art. | Art. | Art. | Art. | Art. | Art. | Art. |
|----------|--|--------|--------|--------|--------|--------|--------|--------|--------|------|-------|
| ∅ 12 mm | Plain Liscio  | 48/B/6 | 48/B/5 | 48/B/4 | 48/B/3 | - | - | - | - | - | - |
| | Hammered Spigolato  | - | - | - | - | 48/B/2 | 48/B/1 | - | - | - | - |
| | Hammered Martellato  | - | - | - | - | - | - | 48/B/8 | 48/B/7 | - | - |
| | Bark effect Corteccia  | - | - | - | - | - | - | - | - | - | 462/3 |

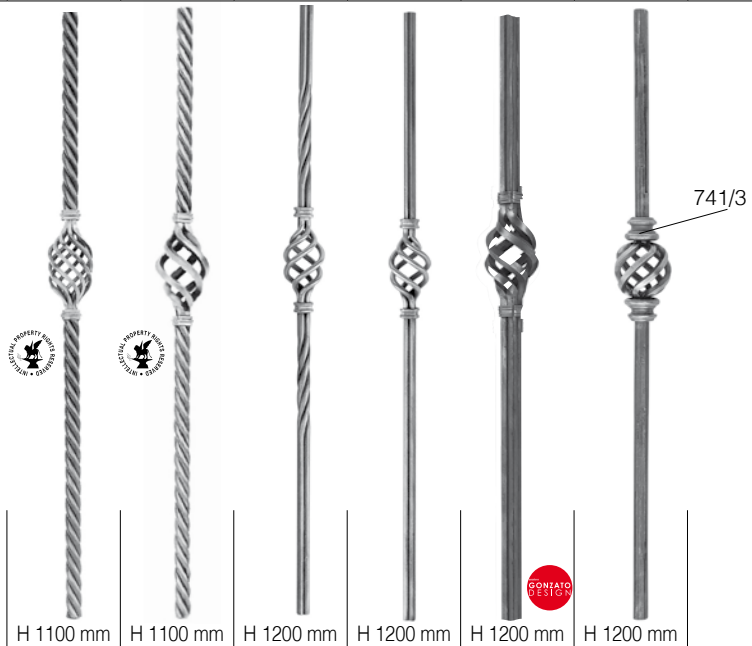

| Sec.Sez. | Finish - Finitura | Art. | Art. | Art. | Art. | Art. | Art. | Art. | Art. |
|----------|---|-------|----------|----------|----------|-------|----------|--------|--------|
| Ø 20 mm | Plain Liscio  | 113/1 | 112/B/15 | 112/B/9 | - | - | - | 1149/7 | - |
| | Hammered Spigolato  | - | - | - | - | 113/3 | 112/B/13 | - | 1149/8 |
| | Hammered Martellato  | - | - | - | 112/B/11 | - | - | - | - |
| Ø 30 mm | Plain Liscio  | 113/2 | 112/B/16 | 112/B/10 | - | - | - | - | - |
| | Hammered Spigolato  | - | - | - | - | 113/4 | 112/B/14 | - | - |
| | Hammered Martellato  | - | - | - | 112/B/12 | - | - | - | - |

i Arterferro products can be manufactured as well as customised.
I prodotti Arterferro sono realizzabili anche su misura.



| Sezione | Finish - Finitura | Art. | Art. | Art. | Art. | Art. | Art. |
|---------|---|-------|-------|--------|--------|--------|--------|
| Ø 30 mm | Grooved Rigato  | - | - | - | - | GD13/1 | - |
| Ø 24 mm | Four-leaf clover Quadrifoglio  | - | - | 1203/2 | 1203/1 | - | - |
| Ø 30 mm | Four-leaf clover rope Quadrifoglio fune  | 801/3 | 801/4 | - | - | - | - |
| Ø 30 mm | Power hamm. Magliato  | - | - | - | - | - | 1204/1 |

Scrolls with forged ends - Riccioli con terminali fucinati

"S" shaped panels - Pannelli ad "S"



Art. 24/F/1
 Ø 12 x 12 mm
 300 x 560 mm



Art. 1050/4
 Ø 12 mm
 265 x 640 mm



Art. 1050/3
 Ø 14 x 14 mm
 265 x 720 mm



Art. 540/2
 Ø 12 mm
 250 x 720 mm



Art. 62/1
 20 x 6 mm
 235 x 720 mm
 Art. 1050/1
 20 x 6 mm
 235 x 720 mm

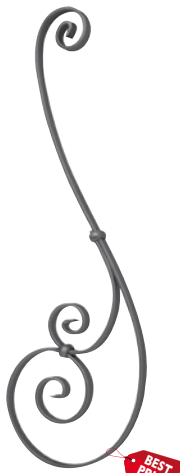

Art. 62/2
 20 x 6 mm
 235 x 720 mm



Art. 63/4
 20 x 6 mm
 235 x 820 mm



Art. 1045/7
 Ø 12 x 12 mm
 250 x 770 mm



Art. 1045/8
 Ø 12 x 12 mm
 250 x 770 mm



Art. 1045/5
 Ø 12 x 12 mm
 250 x 770 mm



Art. 1045/6
 Ø 12 x 12 mm
 250 x 770 mm



Art. 1046/1
 Ø 12 x 12 mm
 250 x 900 mm



Art. 1046/2
 Ø 12 x 12 mm
 200 x 900 mm

"S" shaped panels - Pannelli ad "S"



Art. 1051/4
 ∅ 12 x 6 mm
 150 x 400 mm
 Plain - Liscio



Art. 1671/6
 ∅ 12 x 6 mm
 190 x 435 mm
 Plain - Liscio



Art. 1051/5
 ∅ 12 x 6 mm
 185 x 600 mm
 Plain - Liscio

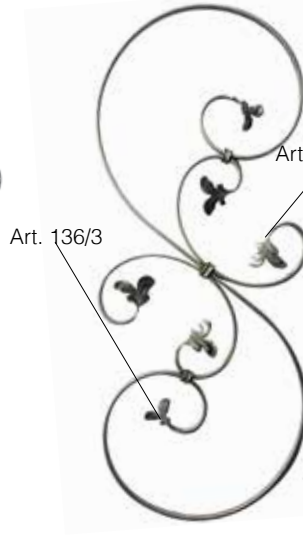

Art. 52/1
 ∅ 12 x 6 mm
 350 x 870 mm
 Plain - Liscio

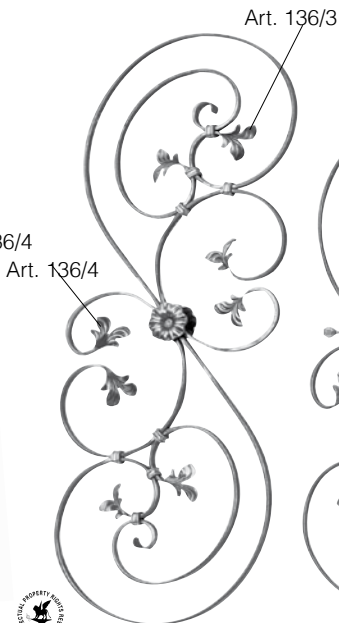

*** Art. 1670/1**
 ∅ 12 x 6 mm
 360 x 1000 mm
 Plain - Liscio



*** Art. 1670/2**
 ∅ 12 x 6 mm
 350 x 870 mm
 Plain - Liscio

*Rosettes 116/A/4 on both sides
 *Rosette 116/A/4 sui 2 lati



Pag. 233

Do you need wrought iron leaves?
 Go to section 15
 Flowers and Rosettes
 Hai bisogno di foglie in ferro battuto?
 Vai al capitolo 15
 Fiori e Rosette

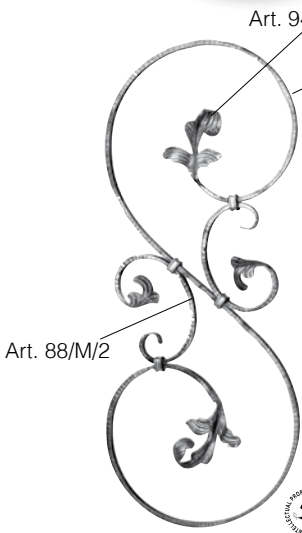

Art. 52/G/1
 ∅ 16 x 8 mm
 370 x 870 mm
 Notched
 Tacchettato

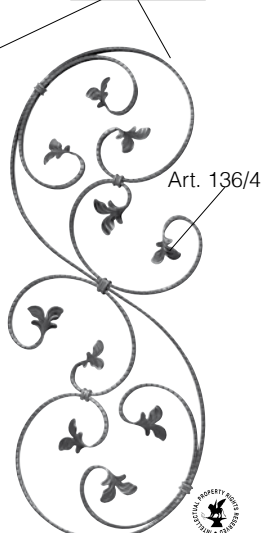

Art. 1671/3
 ∅ 12 x 6 mm
 350 x 870 mm
 Notched
 Tacchettato



Art. 1671/4
 ∅ 12 x 6 mm
 350 x 870 mm
 Hammered
 Spigolato



Art. 541/1
 ∅ 12 x 12 mm
 370 x 900 mm
 Hammered
 Spigolato



Art. 1671/1
 ∅ 12 x 12 mm
 350 x 900 mm
 Hammered
 Spigolato

Art. 541/2
 ∅ 14 mm
 340 x 900 mm
 Plain
 Liscio

Art. 1671/2
 ∅ 12 mm
 350 x 900 mm
 Plain
 Liscio

Hot forged end scrolls - Riccioli terminali fucinati a caldo

"S" shaped panels - Pannelli ad "S"



Art. 681/2
 □ 16 x 8 mm
 270 x 600 mm



Art. 681/1
 □ 16 x 8 mm
 270 x 600 mm



Art. 685/4
 Ø 12 mm
 240 x 590 mm



Art. 685/3
 Ø 12 mm
 240 x 590 mm



Art. 685/2
 Ø 12 mm
 320 x 740 mm



Art. 685/1
 Ø 12 mm
 320 x 740 mm



Art. 681/3
 □ 16 x 8 mm
 320 x 740 mm



Art. 681/4
 □ 16 x 8 mm
 320 x 740 mm



Art. 685/6
 Ø 12 mm
 360 x 810 mm



Art. 685/5
 Ø 12 mm
 360 x 810 mm

"S" shaped panels - Pannelli ad "S"



Arteferro products can be manufactured as well as customised.
I prodotti Arteferro sono realizzabili anche su misura.

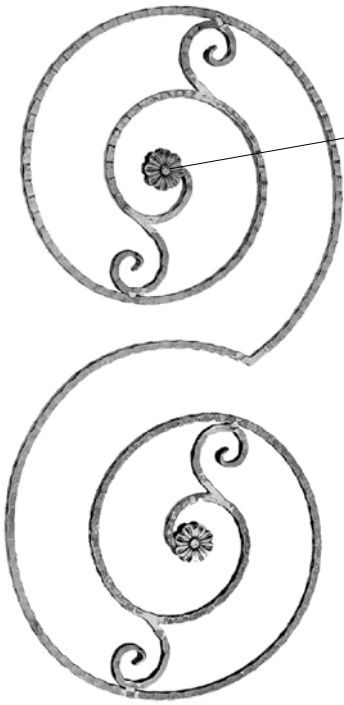

Art. 697/4 on both sides
Art. 697/4 su entrambi i lati

Art. 483/1
Φ 14 x 14 mm
540 x 1100 mm
power hammered
magliato

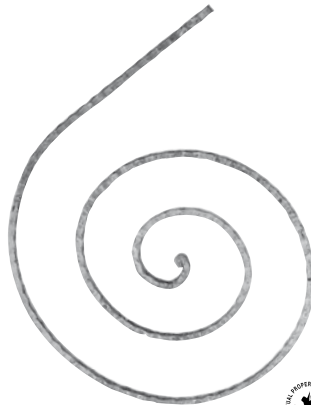

Art. 483/2
Φ 14 x 14 mm
550 x 700 mm
power hammered
magliato

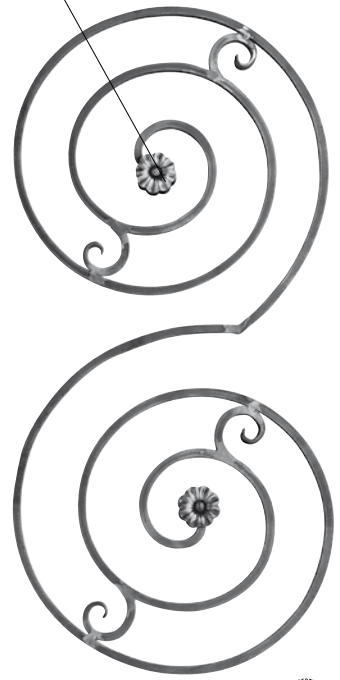

Art. 697/4 on both sides
Art. 697/4 su entrambi i lati

Art. 1038/1
Φ 14 x 14 mm
510 x 1080 mm
plain - liscio

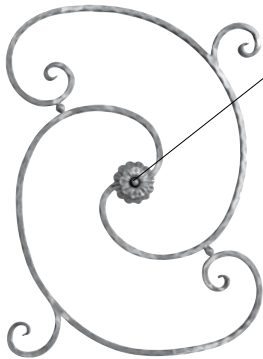

Art. 697/3 on both sides
Art. 697/3 su entrambi i lati

Art. 1040/1
Φ 14 x 14 mm
570 x 760 mm
hammered - spigolato



Art. 1039/1
Φ 14 x 14 mm
570 x 760 mm
hammered - spigolato

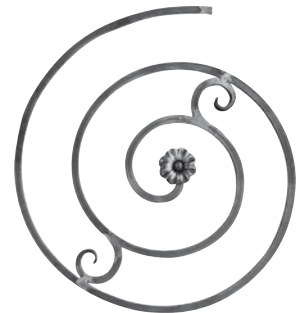

Art. 1038/2
Φ 14 x 14 mm
510 x 560 mm
plain - liscio



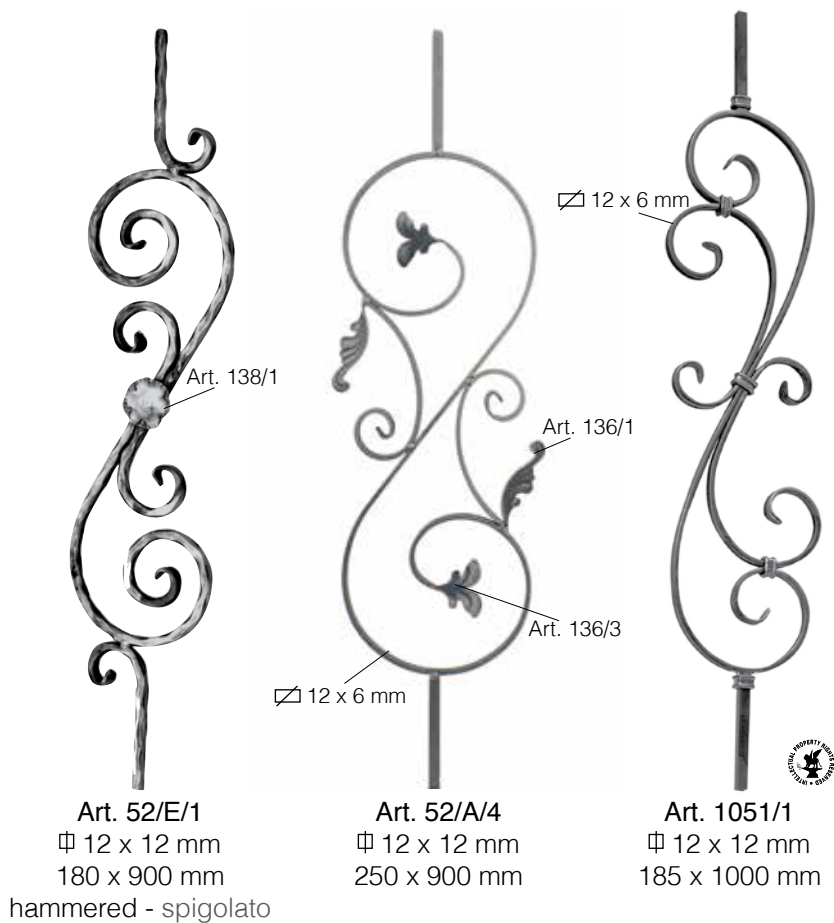
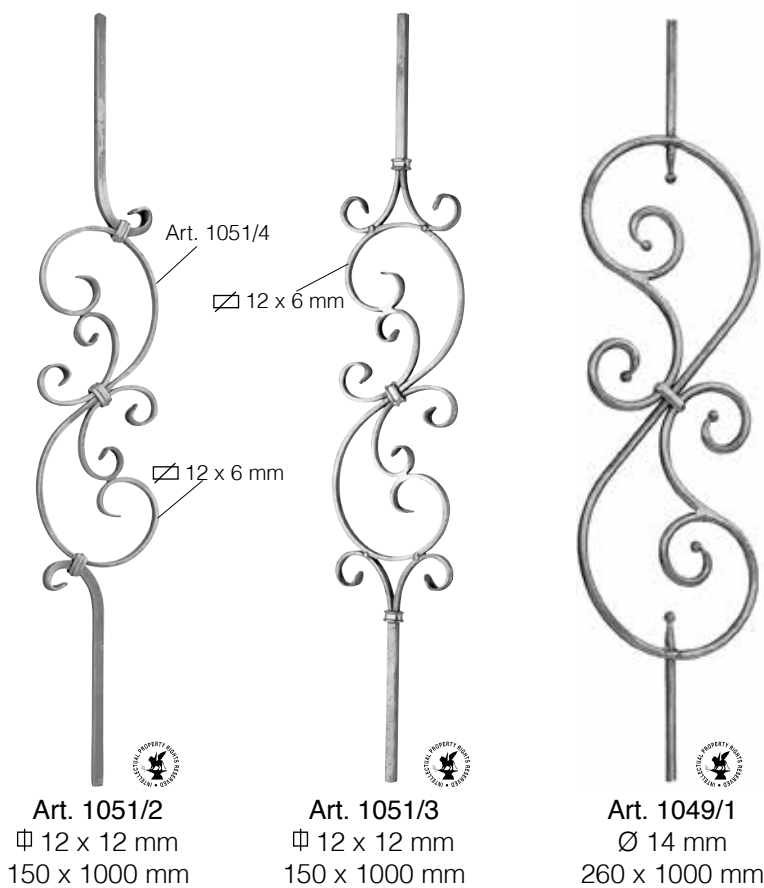



Art. 510/1
 Ø 12 x 12 mm
 250 x 900 mm



Art. 511/1
 Ø 12 x 12 mm
 125 x 900 mm

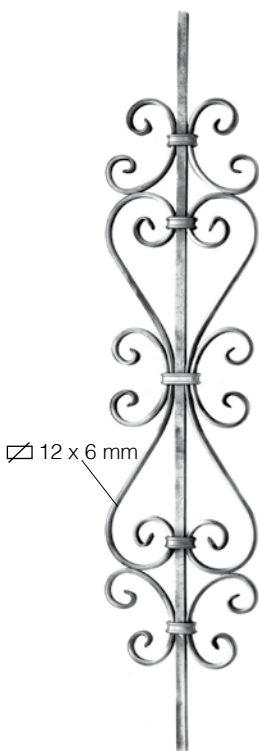

Art. 52/E/2
 Ø 12 x 12 mm
 185 x 900 mm



Art. 59/1
 Ø 20 x 4 mm
 170 x 830 mm



Art. 58/3
 Ø 8 x 8 mm
 160 x 900 mm

BEST PRICE

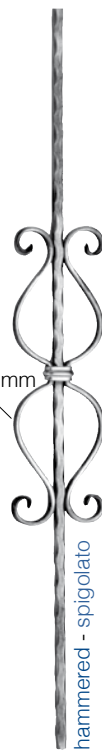

Art. 102/4
 Ø 12 x 12 mm
 110 x 900 mm

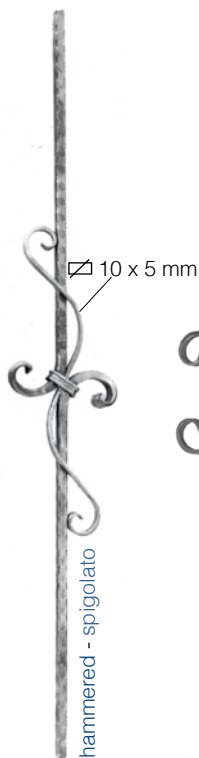

Art. 49/4
 Ø 12 x 12 mm
 125 x 900 mm
 Art. 1753/2
 Ø 12 x 12 mm
 125 x 1000 mm

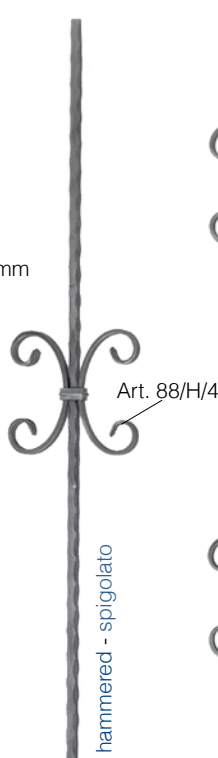

Art. 584/6
 Ø 12 x 12 mm
 165 x 900 mm

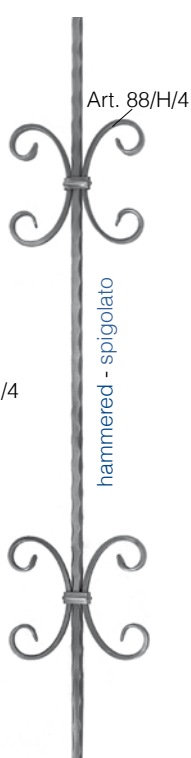

Art. 584/7
 Ø 12 x 12 mm
 165 x 900 mm



Art. 134/G/1
 Ø 12 x 12 mm
 140 x 900 mm

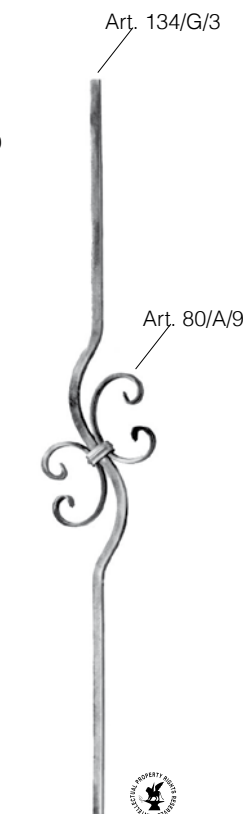

Art. 134/G/2
 Ø 12 x 12 mm
 140 x 900 mm



Art. 97/2
 Ø 14 x 14 mm
 130 x 830 mm

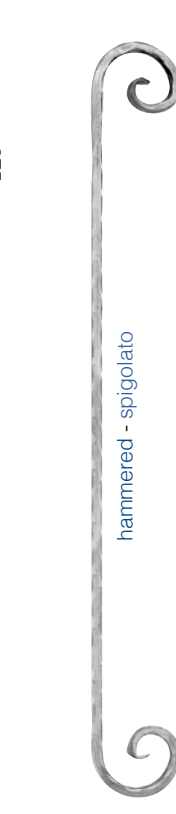

Art. 479/1
 Ø 12 x 12 mm
 110 x 900 mm

Art. 479/3
 Ø 12 x 12 mm
 110 x 1000 mm



Art. 70/E/8
 Ø 14 x 14 mm
 H 900 mm

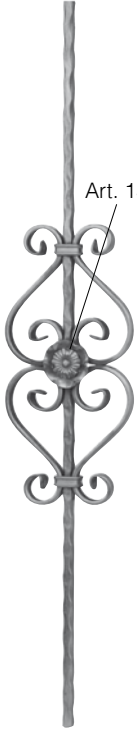

Art. 49/2
 Ø 12 x 12 mm
 165 x 900 mm
 spigolato



Art. 53/2
 Ø 12 x 12 mm
 230 x 900 mm



Art. 539/2
 Ø 12 x 12 mm
 190 x 900 mm



Art. 487/1
 16 x 8 mm
 230 x 900 mm

676/2 on both sides - sui 2 lati



Art. 488/1
 16 x 8 mm
 190 x 900 mm

Rosette 116/A/4 on both sides - sui 2 lati

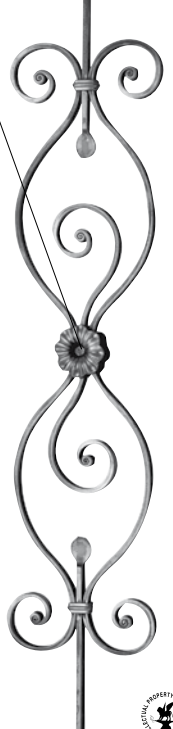

Art. 1678/2
 14 x 8 mm
 205 x 1000 mm

Hollow spheres - Sfere vuote
 Ø 30 mm - Ø 40 mm



Art. 1064/1
 Ø 12 mm
 175 x 1000 mm



Art. 1064/2
 Ø 12 mm
 175 x 1000 mm



Art. 1064/3
 Ø 12 mm
 200 x 1000 mm



Art. 51/3
 Ø 12 x 12 mm
 300 x 900 mm

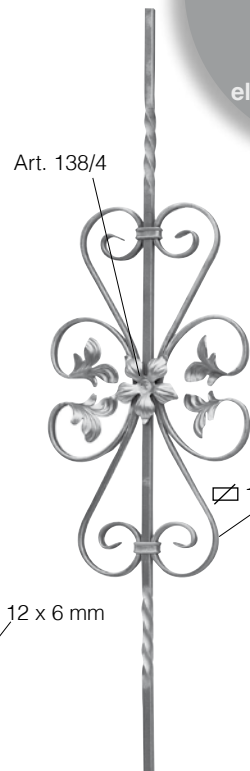

Art. 1753/6
 Ø 12 x 12 mm
 260 x 1000 mm



Pag. 197

In section 11, scrolls and Snap-ons you'll find many items to match
 Nel capitolo 11 Ricci e Snap-ons troverai tanti elementi da abbinare

Panels with scrolls - Pannelli con ricci

Rosette 116/A/4 on both sides - sui 2 lati



Art. 1647/3
 ∅ 12 x 6 mm
 200 x 500 mm

Rosette 116/A/4 on both sides - sui 2 lati



Art. 473/1
 ∅ 12 x 12 mm
 380 x 900 mm

Art. 1304/1



Art. 474/1
 ∅ 12 x 12 mm
 380 x 755 mm

Art. 138/4 on both sides su 2 lati

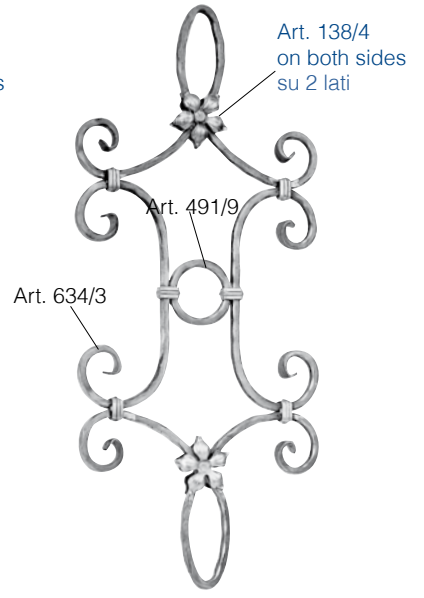

Art. 479/2
 ∅ 12 x 12 mm
 385 x 900 mm

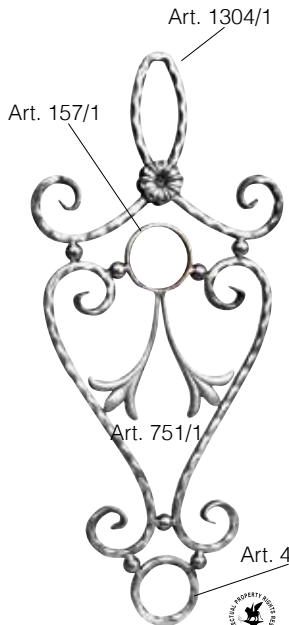

Art. 475/1
 hammered - spigolato
 ∅ 12 x 12 mm
 380 x 825 mm

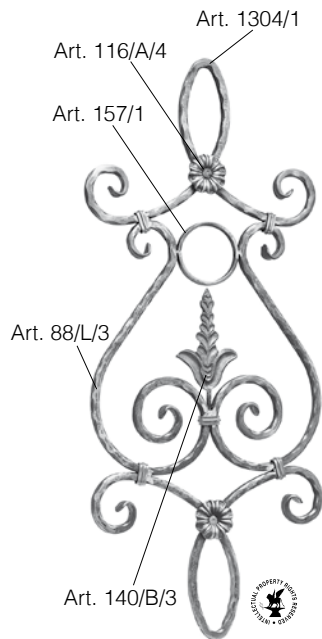

Art. 475/2
 hammered - spigolato
 ∅ 12 x 12 mm
 380 x 900 mm



Hot forged ends - Terminali fucinati a caldo

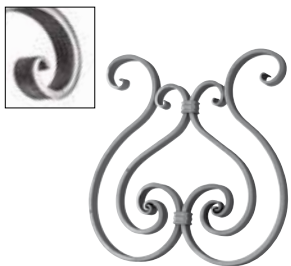

Art. NEW0011
 ∅ 16 x 6 mm
 260 x 260 mm



Art. NEW0009
 ∅ 16 x 6 mm
 260 x 515 mm



Art. GD270/5
 ∅ 16 x 6 mm
 260 x 515 mm



Art. NEW0016
 ∅ 16 x 6 mm
 175 x 510 mm



Arteferro pickets and panels are amongst the most important items in the composition of an infill of a balustrade or fence. The modern design of these new lines of items reinterprets in a contemporary way, the elegance and refinement of traditional materials like wrought iron.

I paletti e pannelli Arteferro sono tra gli elementi più importanti nella composizione del tamponamento di un parapetto o di una recinzione. Il design moderno di queste nuove linee di elementi reinterpreta in chiave contemporanea l'eleganza e la raffinatezza di un materiale tradizionale come il ferro battuto.

PALETTI E PANNELLI MODERNI MODERN PICKETS AND PANELS

5. Modern pickets and Panels
Paletti e Pannelli moderni



- A Geometric Style pag.114
- B Linear Style pag.120
- C Floreal Style pag.129
- D Waves Style pag.132
- E Impero Style pag.135
- F Revolution Style pag.137
- G New Classic Style pag.141
- H New Liberty Style pag.148

Most of the pickets and panels have been classified to make it easier for you to find the item you want quickly and easily. Starting with the central motif you can find your article with its finish and the matching decorations.

Molti paletti e pannelli sono stati classificati per dare la possibilità di trovare in modo veloce e pratico l'articolo desiderato. Parti dal motivo centrale troverai il tuo articolo con la lavorazione e i decori abbinabili.



Art. GD59/2
 ∅ 12 x 12 mm
 55 x 1000 mm
 Art. GD59/2/Q14
 ∅ 14 x 14 mm
 55 x 1000 mm

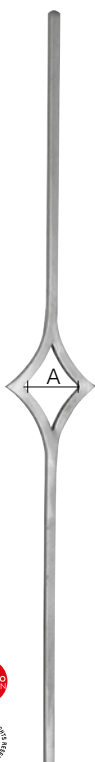

Art. GD23/1
 ∅ 14 mm
 120 x 1000 mm
 A = 75 mm
 Art. GD58/3 **BEST PRICE**
 ∅ 12 mm
 120 x 1000 mm
 A = 80 mm

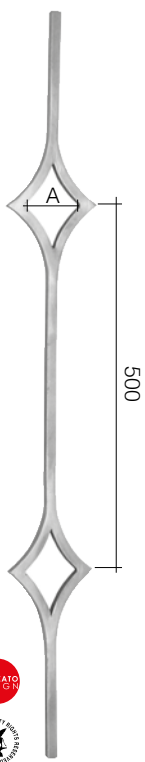

Art. GD25/1
 ∅ 14 mm
 120 x 1000 mm
 A = 75 mm
 Art. GD58/2
 ∅ 12 mm
 120 x 1000 mm
 A = 80 mm



Art. GD19/1
 ∅ 14 x 8 mm
 100 x 1000 mm

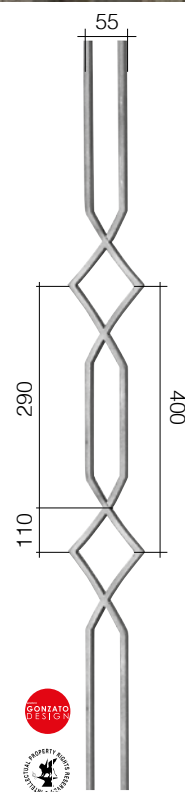

Art. GD19/2
 ∅ 14 x 8 mm
 100 x 1000 mm

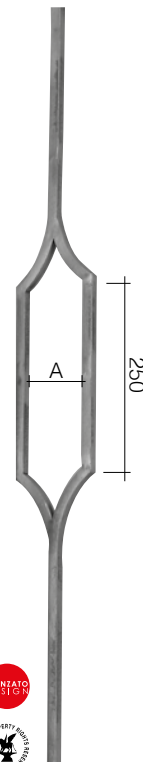

Art. GD25/3
 ∅ 14 mm
 110 x 1000 mm
 A = 82 mm
 Art. GD243/2
 ∅ 12 mm
 110 x 1000 mm
 A = 86 mm

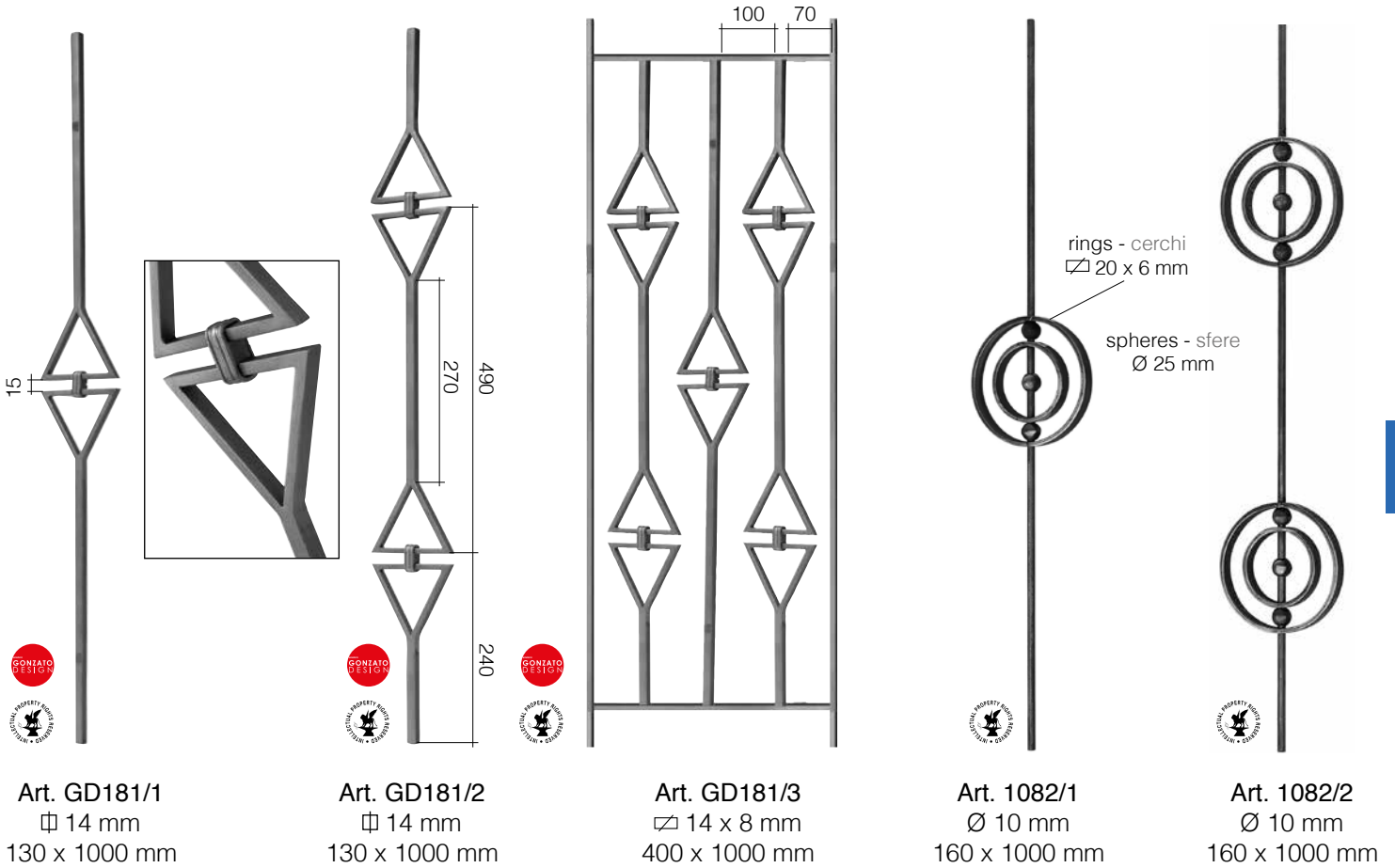

Ornaments - Ornamenti □ 14 x 8 mm

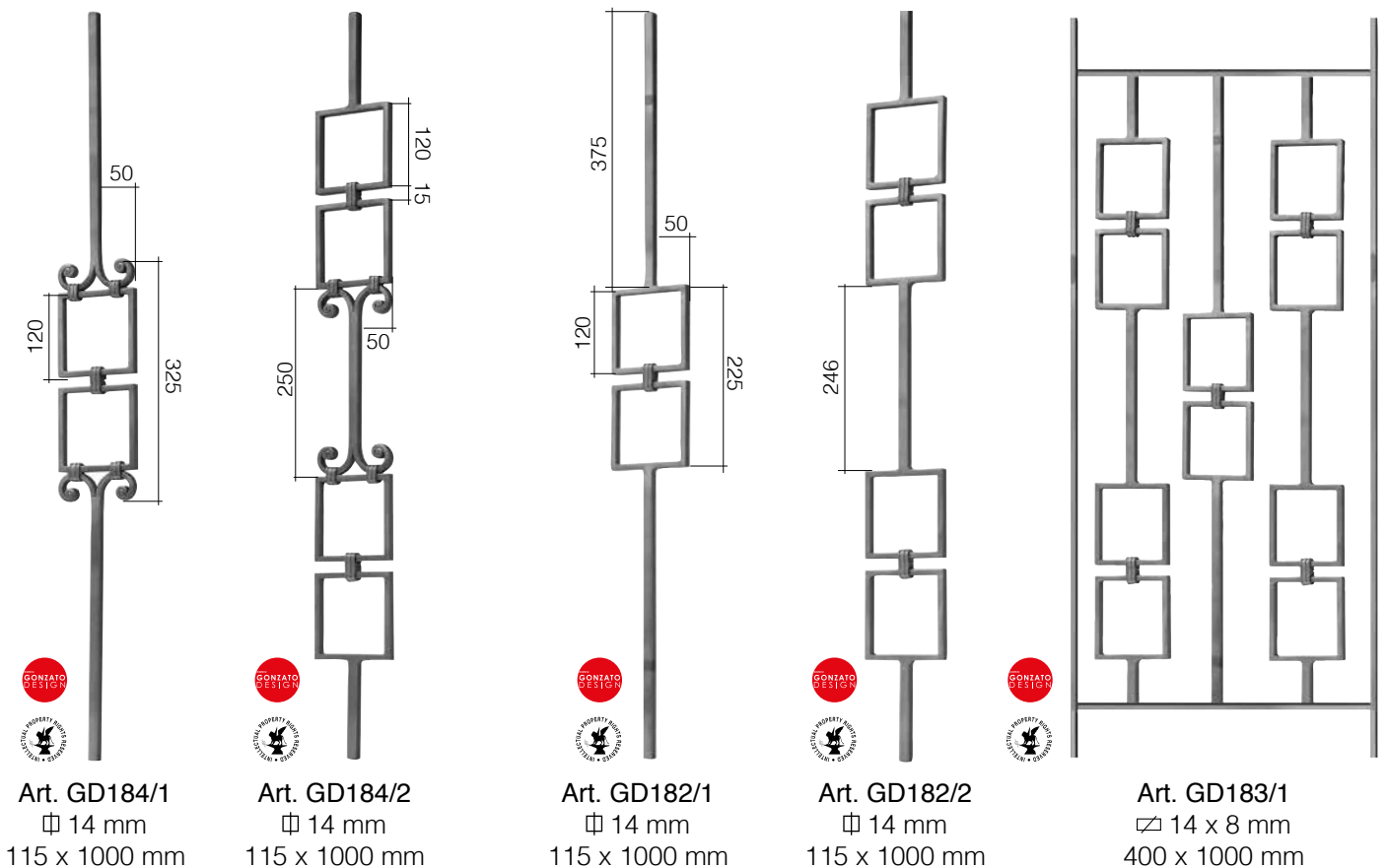

Geometric Style

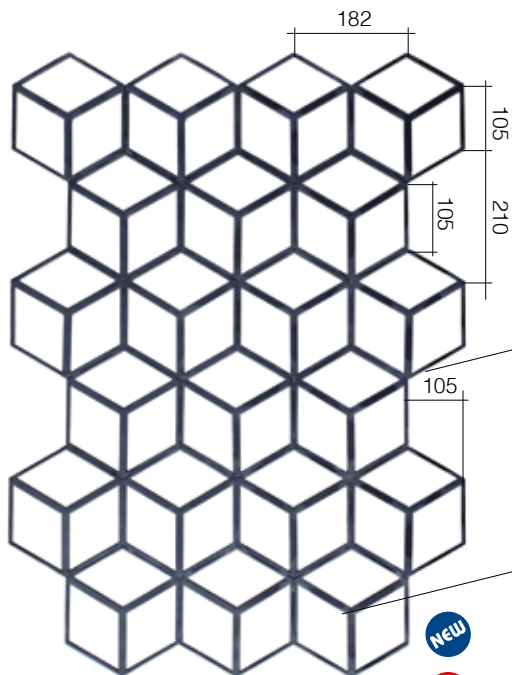

Art. GD287/1
 $12 \times 6 \text{ mm} + \varnothing 12 \text{ mm}$
 729 x 1000 mm

NEW

GONZATO DESIGN

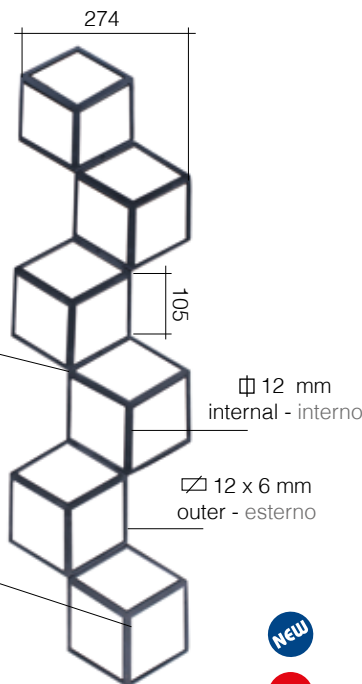

Art. GD287/2
 $12 \times 6 \text{ mm} + \varnothing 12 \text{ mm}$
 274 x 1000 mm

NEW

GONZATO DESIGN

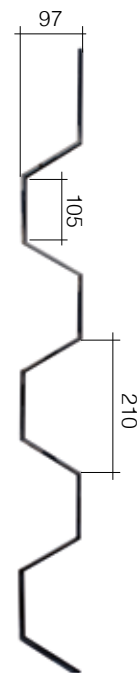

Art. GD287/3
 $12 \times 6 \text{ mm}$
 H 1000 mm

NEW

GONZATO DESIGN



APPLICATION ON STAIRCASE
 ESEMPIO DI MONTAGGIO SU SCALA

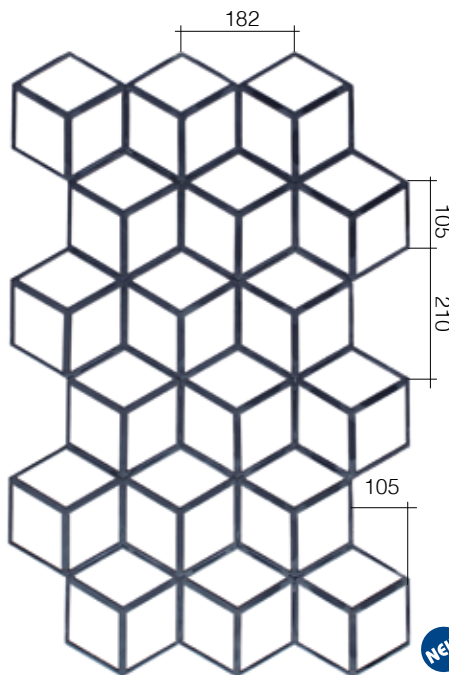

Art. GD287/4
 $12 \times 6 \text{ mm} + \varnothing 12 \text{ mm}$
 638 x 1000 mm

NEW

GONZATO DESIGN

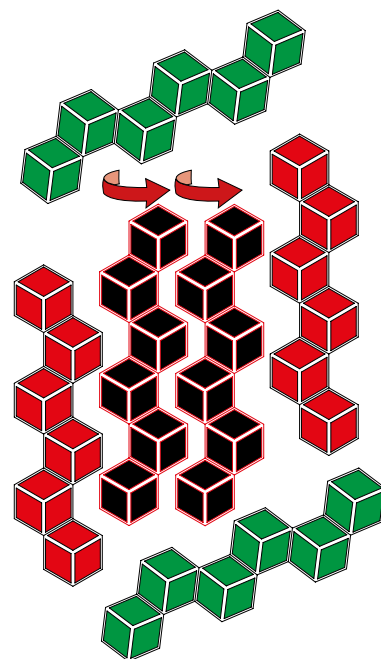

Geometric Style

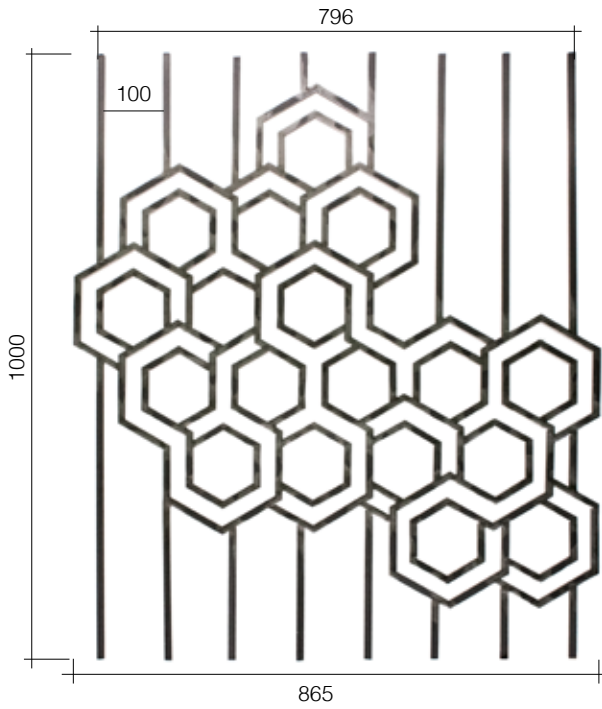

Art. GD301/1
 Ø 12 x 12 mm
 865 x 1000 mm

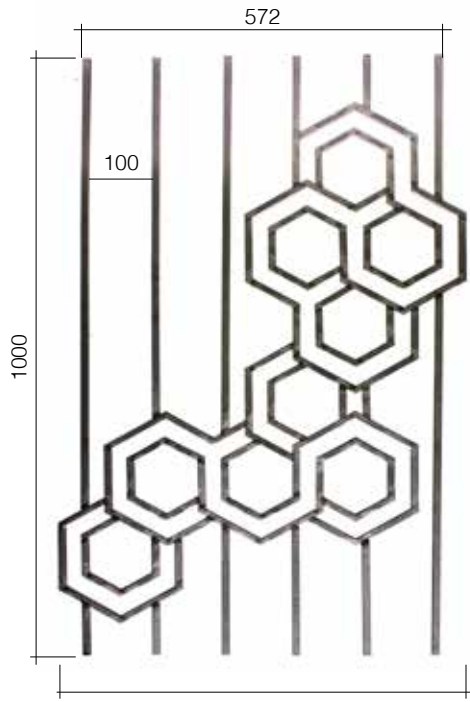
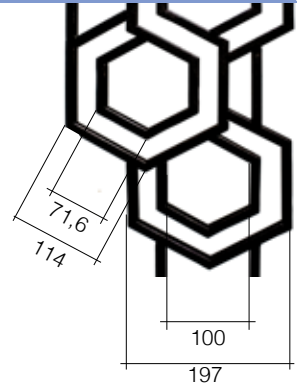

Art. GD301/2
 Ø 12 x 12 mm
 642 x 1000 mm

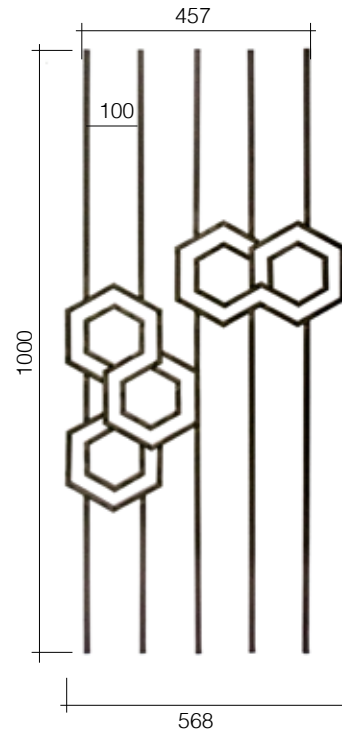

Art. GD301/3
 Ø 12 x 12 mm
 568 x 1000 mm

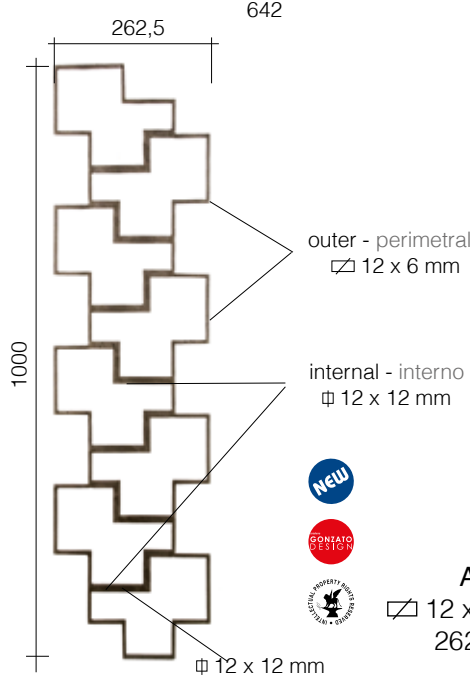

outer - perimetrale
 □ 12 x 6 mm

internal - interno
 □ 12 x 12 mm



Art. GD293/1
 □ 12 x 6 mm + Ø 12 mm
 262,5 x 1000 mm



OVERLAPPED PANELS - PANNELLI SOVRAPPOSTI

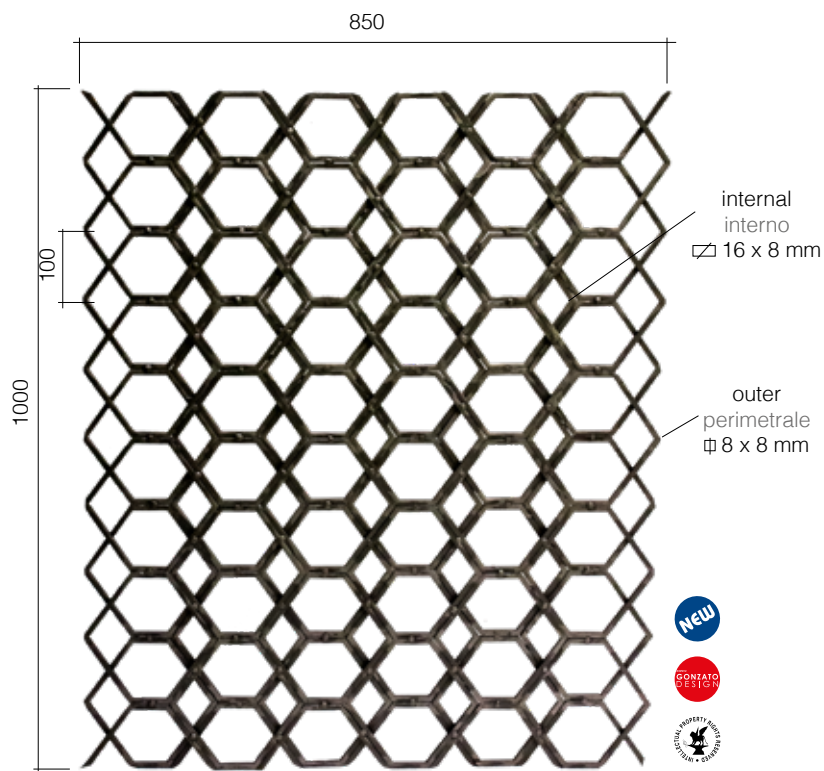

Art. GD299/1
 $\Phi 8 \times 8 \text{ mm} + \square 16 \times 8 \text{ mm}$
 850 x 1000 mm

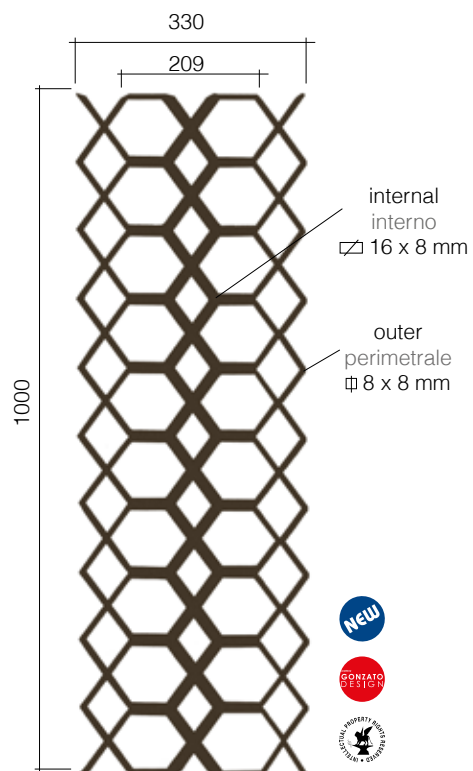

Art. GD299/2
 $\Phi 8 \times 8 \text{ mm} + \square 16 \times 8 \text{ mm}$
 330 x 1000 mm

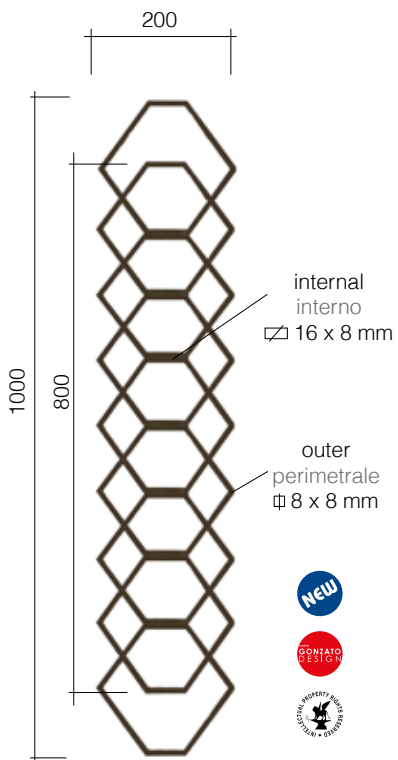

Art. GD299/3
 $\Phi 8 \times 8 \text{ mm} + \square 16 \times 8 \text{ mm}$
 200 x 1000 mm

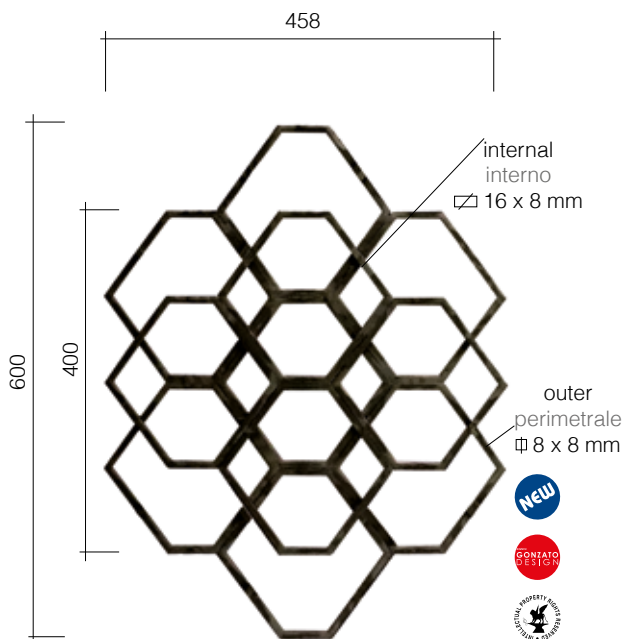

Art. GD299/4
 $\Phi 8 \times 8 \text{ mm} + \square 16 \times 8 \text{ mm}$
 458 x 600 mm



OVERLAPPED PANELS
PANNELLI SOVRAPPOSTI



Panels with sheet metal, 1 mm thick woven between rods, 8 mm diameter

Pannelli con lamiera spessore 1 mm intrecciata tra tondini Ø 8 mm

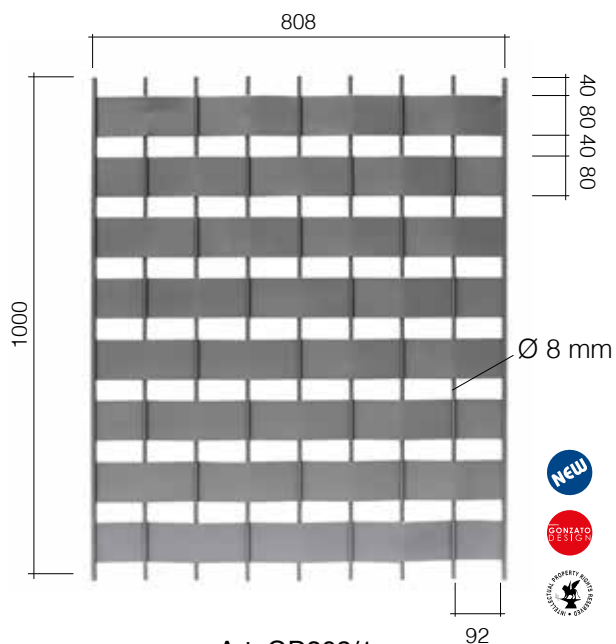

Art. GD302/1
 16 x 8 mm
 808 x 1000 mm

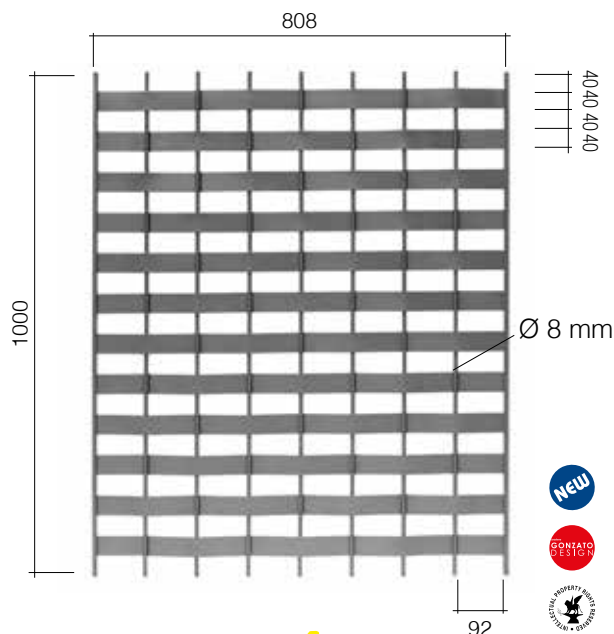

Art. GD302/2
 16 x 8 mm
 808 x 1000 mm

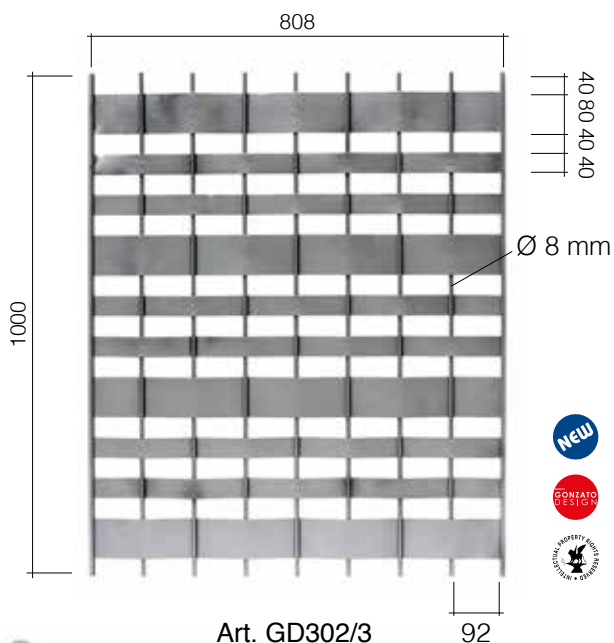

Art. GD302/3
 16 x 8 mm
 808 x 1000 mm

i **ATTENZIONE:**
 Viste le peculiarità del prodotto, questo articolo è solo zincabile a freddo. Una zincatura a caldo potrebbe comprometterne l'estetica

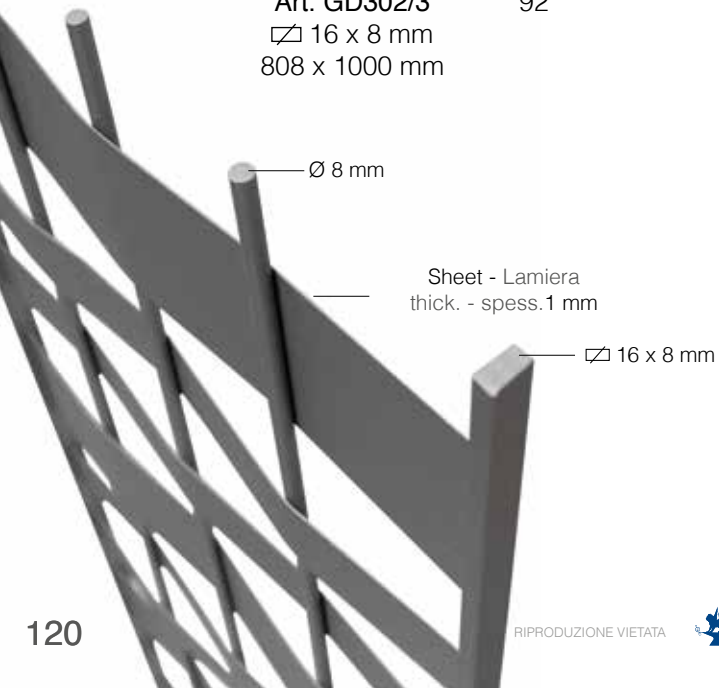

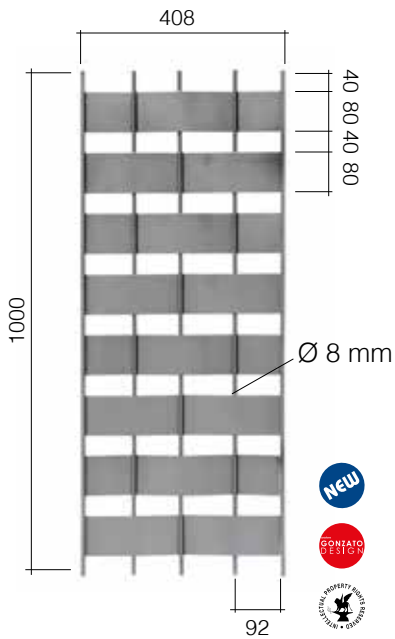

Art. GD303/1
 □ 16 x 8 mm
 408 x 1000 mm

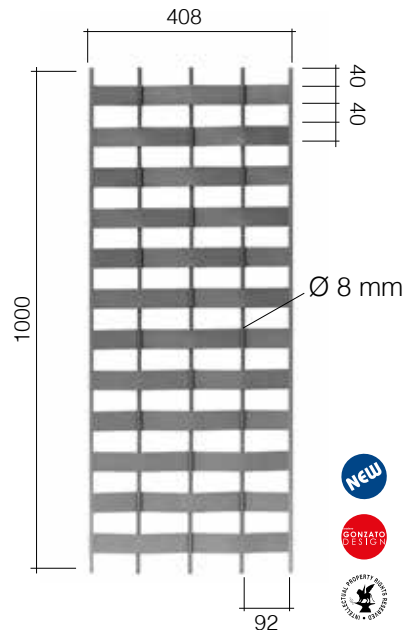

Art. GD303/2
 □ 16 x 8 mm
 408 x 1000 mm

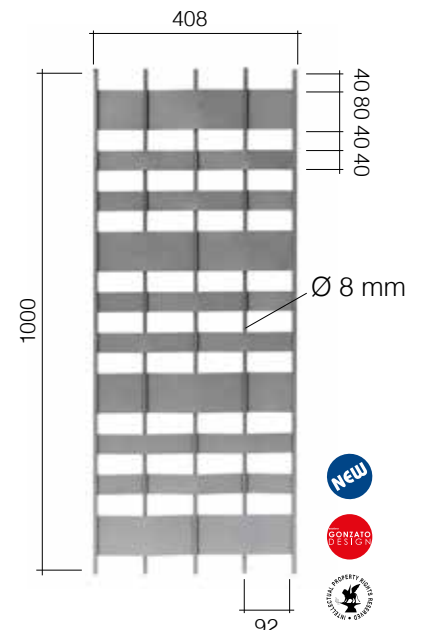

Art. GD303/3
 □ 16 x 8 mm
 408 x 1000 mm



i CAUTION:
 Considering the peculiarities of this item only **cold galvanizing** is recommended. Hot dip galvanizing would compromise its shape.

Linear Style

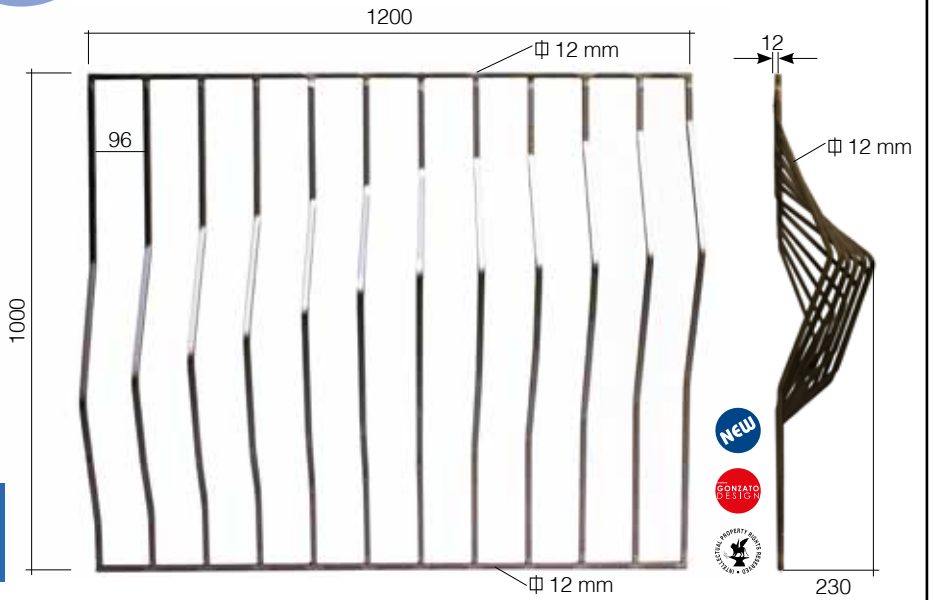

left - sinistro
Art. GD289/2
 12 x 12 mm
 1200 x 1000 mm

right - destro
Art. GD289/2/S
 12 x 12 mm
 1200 x 1000 mm

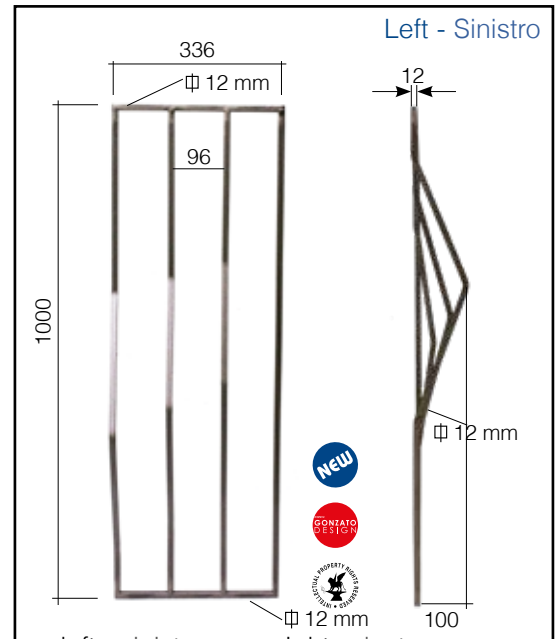

left - sinistro
Art. GD293/3
 12 x 12 mm
 336 x 1000 mm

right - destro
Art. GD293/3/S
 12 x 12 mm
 336 x 1000 mm

Elements to lead the buffing waves at level zero
 Elementi per portare l'onda di tamponatura a livello zero

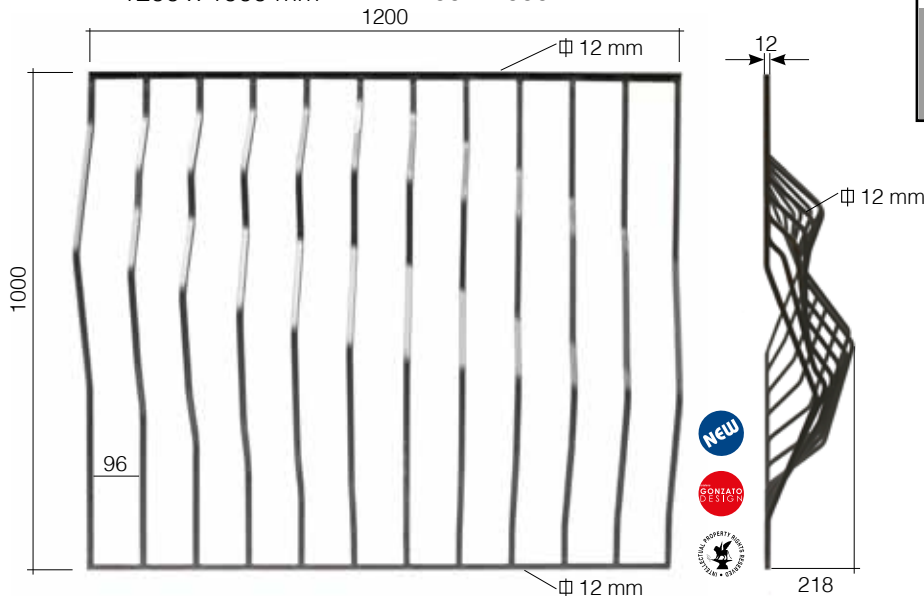

left - sinistro
Art. GD289/1
 12 x 12 mm
 1200 x 1000 mm

right - destro
Art. GD289/1/S
 12 x 12 mm
 1200 x 1000 mm



vertical elements Ø 12 mm
horizontal elements \varnothing 12 mm

elementi verticali Ø 12 mm
elementi orizzontali \varnothing 12 mm

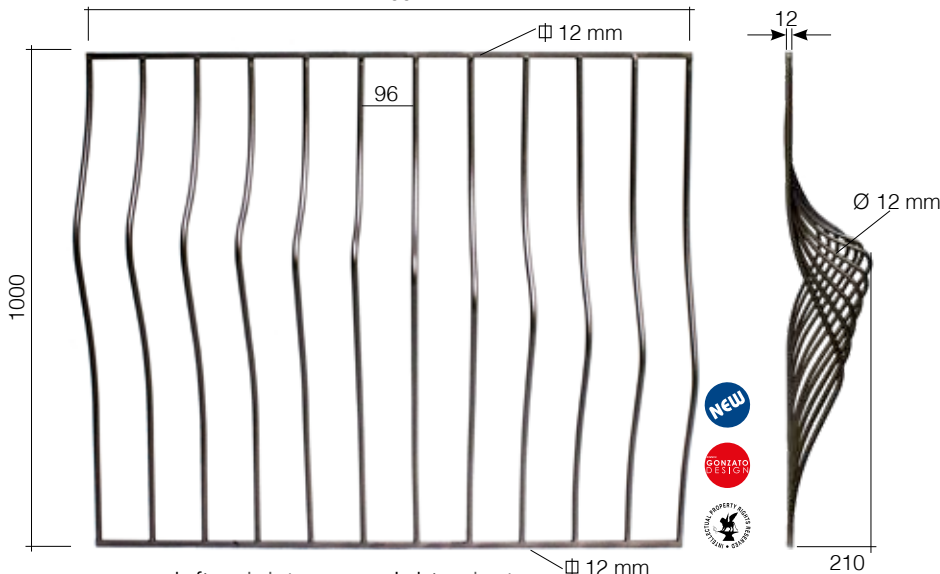

left - sinistro Art. GD294/1
right - destro Art. GD294/1/S
Ø 12 mm Ø 12 mm
1200 x 1000 mm 1200 x 1000 mm

Linear Style

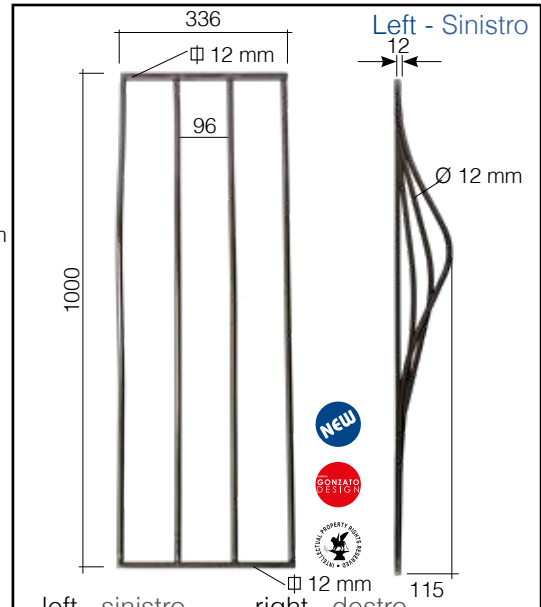

left - sinistro Art. GD294/3
right - destro Art. GD294/3/S
Ø 12 mm Ø 12 mm
336 x 1000 mm 336 x 1000 mm

Elements to lead the buffing waves at level zero
Elementi per portare l'onda di tamponatura a livello zero

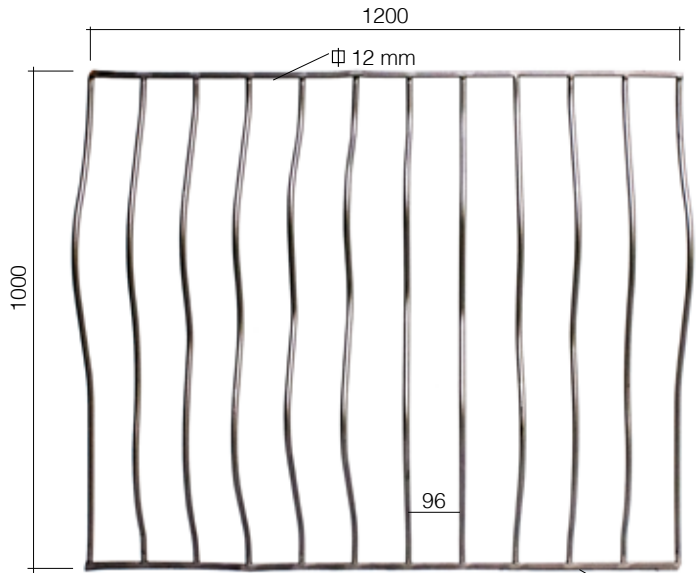

left - sinistro Art. GD294/2
right - destro Art. GD294/2/S
Ø 12 mm Ø 12 mm
1200 x 1000 mm 1200 x 1000 mm

vertical elements Ø 12 mm
horizontal elements \varnothing 12 mm
elementi verticali Ø 12 mm
elementi orizzontali \varnothing 12 mm

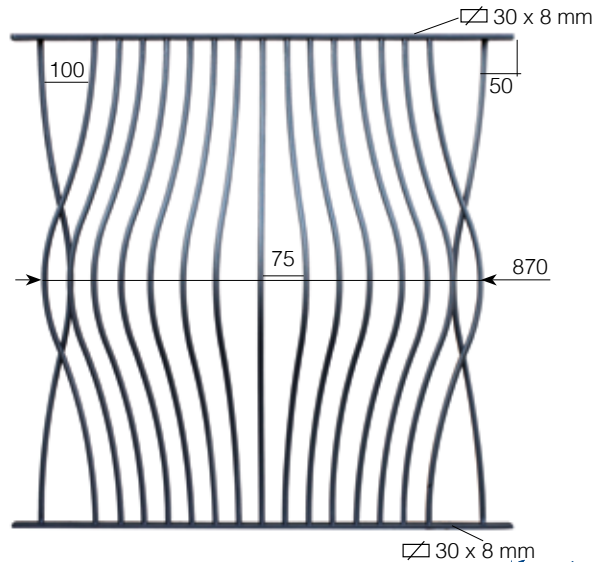

vertical elements Ø 12 mm
horizontal elements \varnothing 30 x 8 mm
elementi verticali Ø 12 mm
elementi orizzontali \varnothing 30 x 8 mm

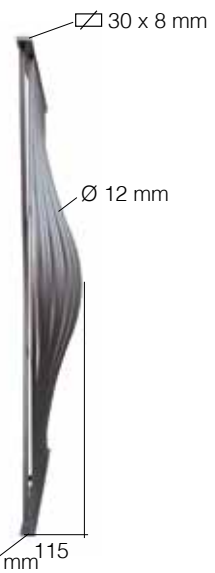

Art. GD288/1
Ø 12 mm
1000 x 1000 mm

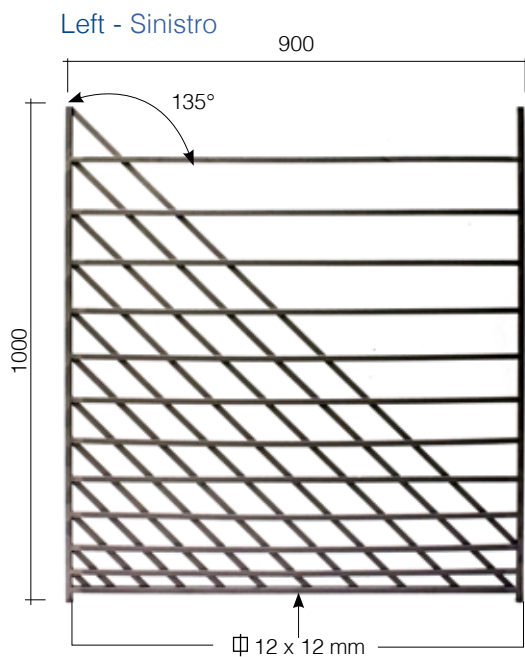

left - sinistro
Art. GD297/1
 □ 12 x 6 mm + Ø 12 mm
 L 900 mm
 H 1000 mm



right - destro
Art. GD297/2
 □ 12 x 6 mm + Ø 12 mm
 L 900 mm
 H 1000 mm

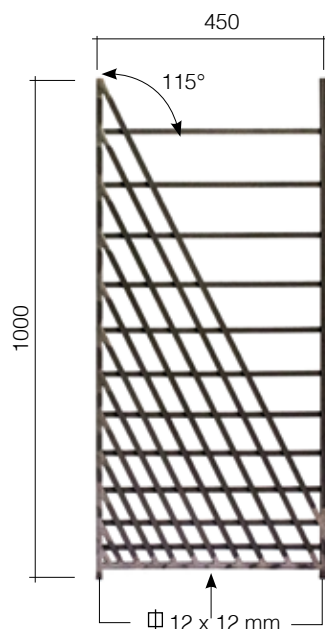

left - sinistro
Art. GD298/1
 □ 12 x 6 mm + Ø 12 mm
 L 450 mm
 H 1000 mm



right - destro
Art. GD298/2
 □ 12 x 6 mm + Ø 12 mm
 L 450 mm
 H 1000 mm



Linear Style

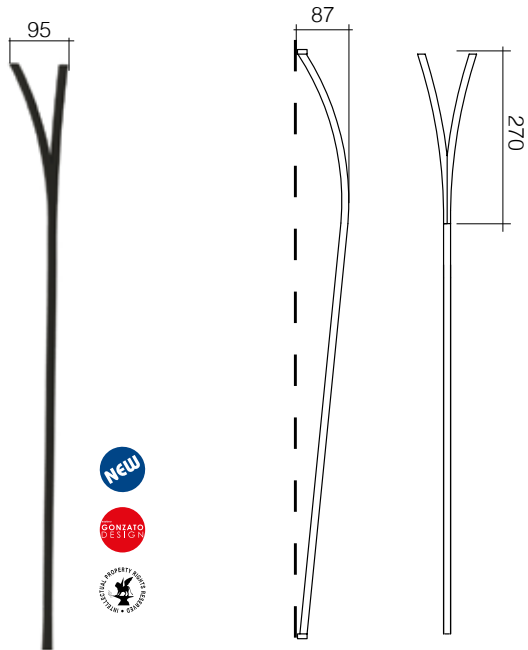

Art. GD290/2
 Ø 12 mm
 H 1000 mm

NEW

GONIAIO DESIGN



BEST PRICE

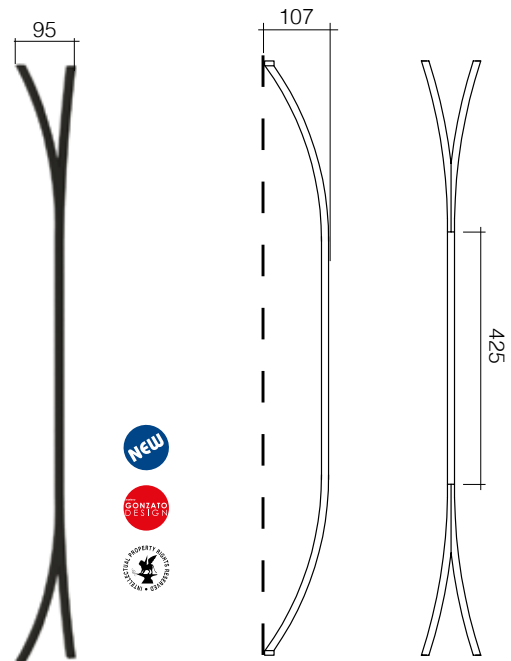

Art. GD290/1
 Ø 12 mm
 H 1000 mm

NEW

GONIAIO DESIGN



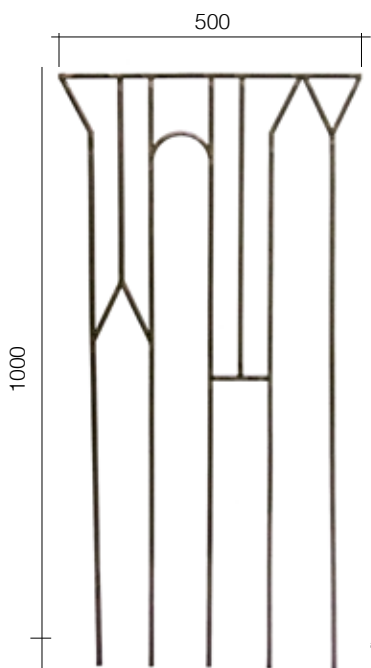

Art. GD295/1
 □ 14 x 8 mm
 500 x 1000 mm

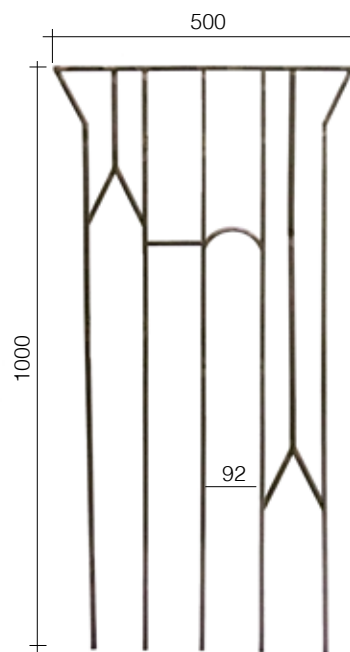

Art. GD295/2
 □ 14 x 8 mm
 500 x 1000 mm



Not all of the Arterferro items are available in Arterferro Quick, just a special selection. Find out about the entire range in the catalogue

In Arterferro Quick non sono presenti tutti gli articoli Arterferro, ma solo una speciale selezione. Scopri la gamma completa nel catalogo

Compendium



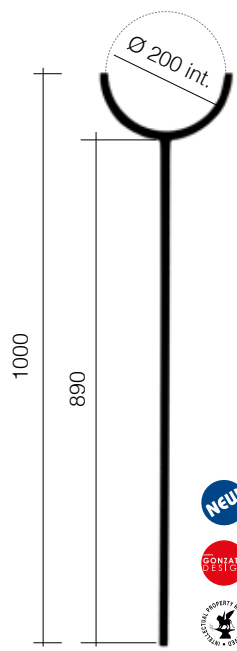

Art. GD296/1
 Ø 12 x 12 mm
 Ø 224 x 1000 mm

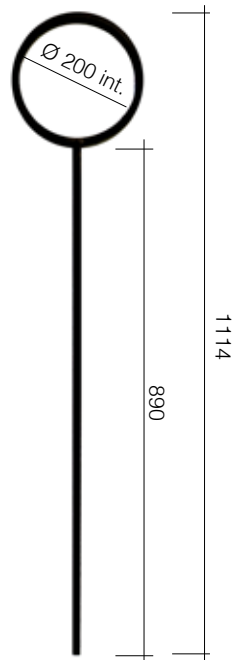

Art. GD296/2
 Ø 12 x 12 mm
 Ø 224 x 1114 mm

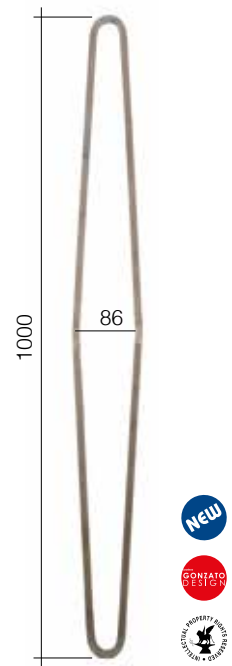

Art. GD293/2
 Ø 12 x 12 mm
 110 x 1000 mm





Spheres - Sfere Ø 30 mm

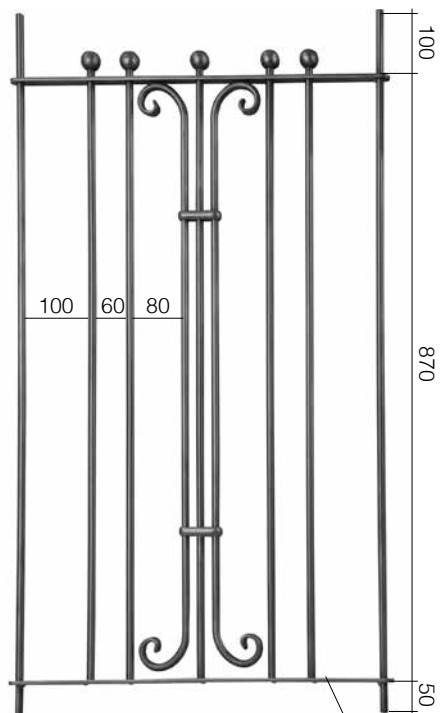

Art. GD45/1
 Ø 12 mm
 H 1000 mm
 L 610 mm



25 x 6 mm

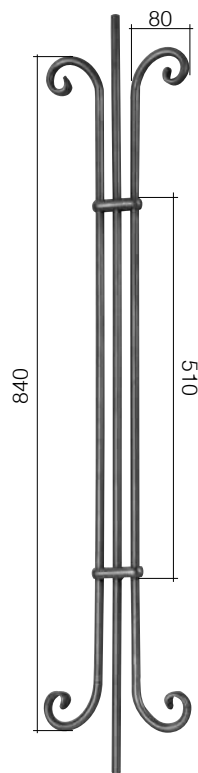

Art. GD45/2
 Ø 12 mm
 H 1000 mm
 L 200 mm

Art. 116/F/3
 Ø 30 mm



Art. GD43/1
 Ø 12 mm
 H 1000 mm

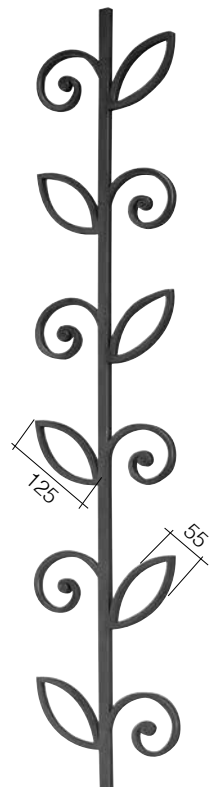
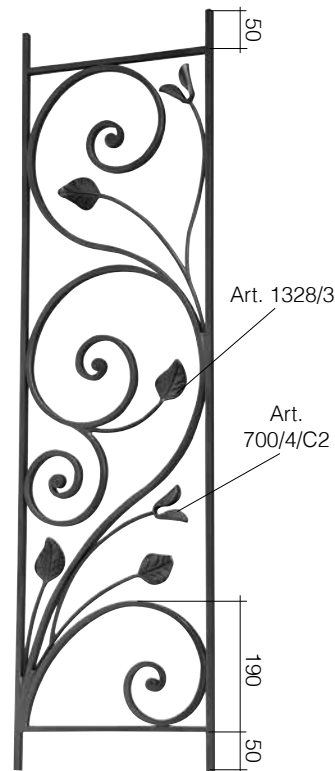

Art. GD222/1
 □ 14 x 8 mm
 H 1000 mm
 L 500 mm

Art. GD222/2
 □ 14 x 8 mm
 H 1000 mm
 L 500 mm

Art. GD223/1
 □ 14 x 8 mm
 H 1000 mm
 L 275 mm

Art. GD176/3
 ∅ 14 x 14 mm
 200 x 1000 mm



Art. 1170/1
 ∅ 12 mm
 130 x 1000 mm



Art. 1170/5
 ∅ 12 mm
 70 x 1000 mm



Art. 1170/6
 ∅ 12 mm
 70 x 1000 mm



Art. 1170/2
 ∅ 12 mm
 130 x 1000 mm



Art. 1171/1
 ∅ 12 mm
 120 x 1000 mm

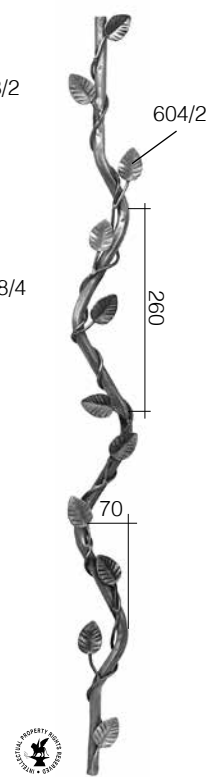

Art. 604/6
 ∅ 12 mm
 H 1000 mm

spheres - sfere 116/F/4 Ø 40 mm

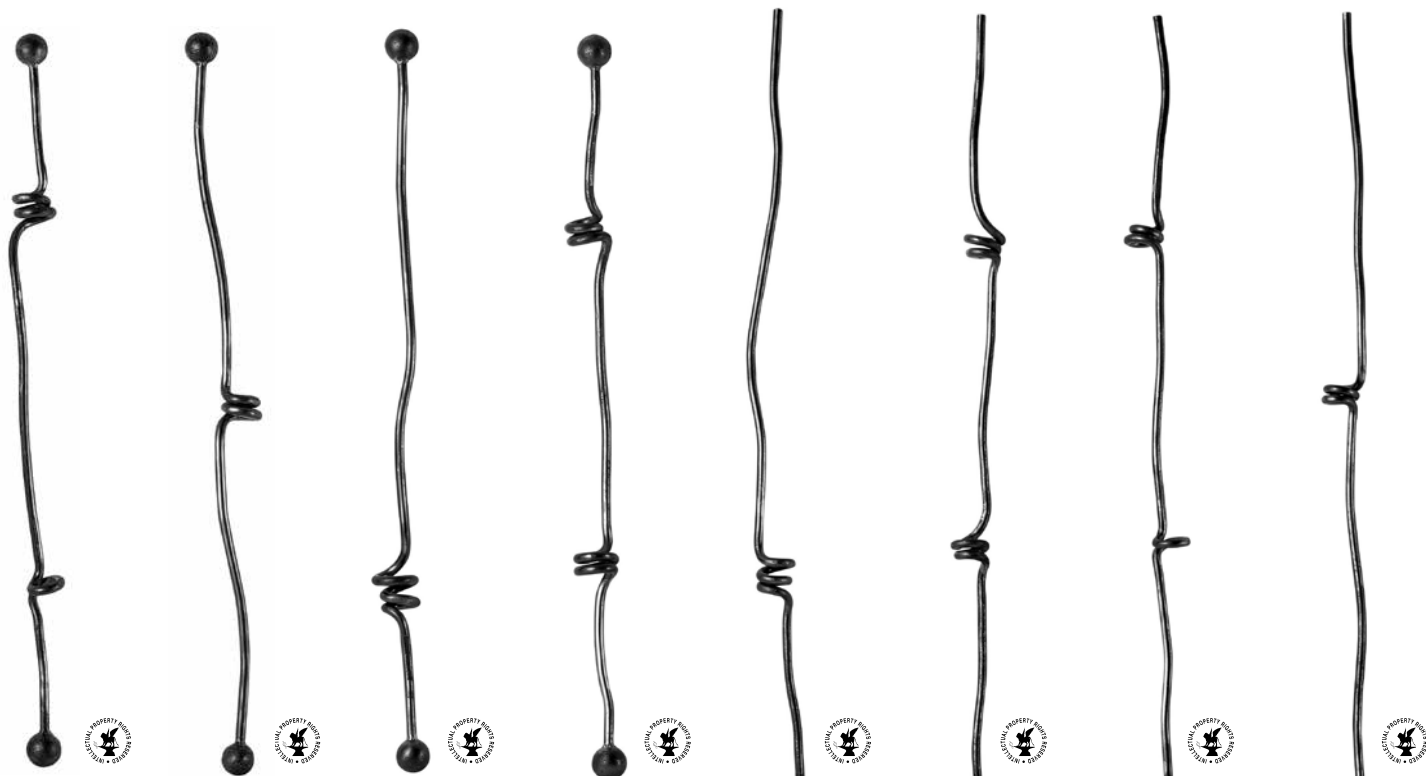

Art. 1166/1
Ø 12 mm
H 900 mm

Art. 1166/2
Ø 12 mm
H 900 mm

Art. 1166/3
Ø 12 mm
H 900 mm

Art. 1166/4
Ø 12 mm
H 900 mm

Art. 1167/3
Ø 12 mm
H 1000 mm

Art. 1167/4
Ø 12 mm
H 1000 mm

Art. 1167/1
Ø 12 mm
H 1000 mm

Art. 1167/2
Ø 12 mm
H 1000 mm

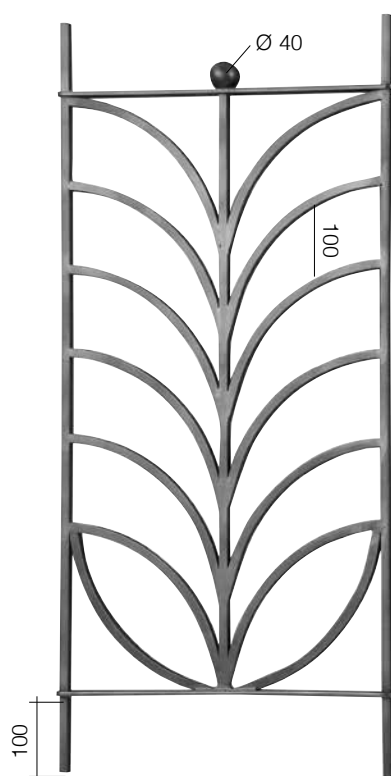

Art. GD73/1
Ø 12 x 12 mm
455 x 1000 mm

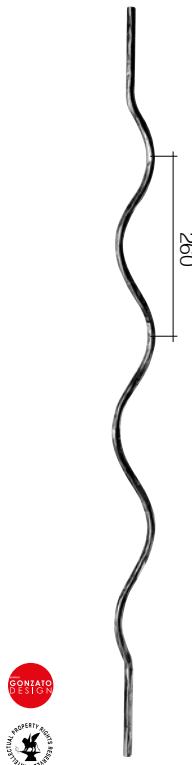

Art. 1171/2
Ø 12 mm
60 x 1000 mm



Art. GD92/3
Ø 12 mm
100 x 1000 mm



Art. GD92/2
Ø 12 mm
130 x 1000 mm

Floreal Style



left - sinistro

Art. 715/1
Ø 12 mm
580 x H 880 mm
left - sinistro

Art. 715/2
Ø 12 mm
580 x H 880 mm
right - destro

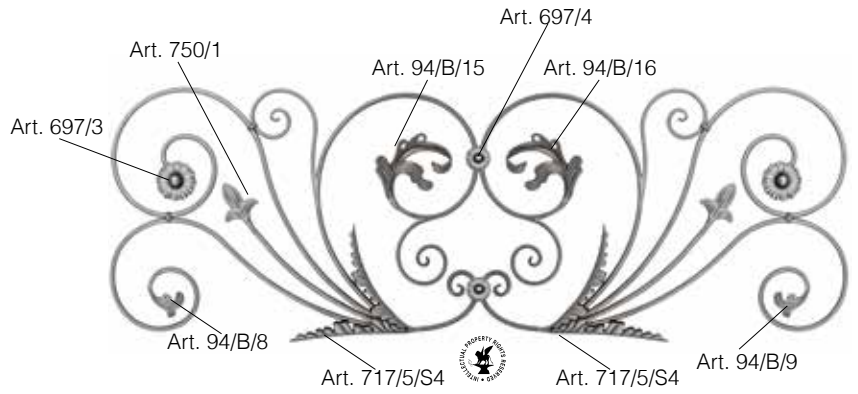

Art. 713/2
Ø 12 mm
1780 x H 580 mm



left - sinistro

Art. 716/1
Ø 12 mm
920 x H 1280 mm
left - sinistro

Art. 716/2
Ø 12 mm
920 x H 1280 mm
right - destro

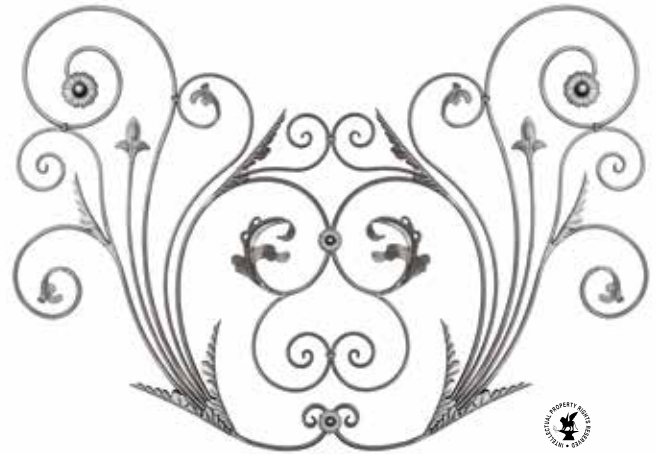

Art. 714/1
Ø 12 mm
1600 x H 1150 mm



left - sinistro

Art. 716/3
Ø 12 mm
760 x H 890 mm
right - destro

Art. 716/4
Ø 12 mm
760 x H 890 mm
left - sinistro



Art. 713/1
Ø 12 mm
1780 x H 760 mm

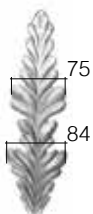

NEW

Art. 717/5/S1
H 285 mm
Ø 2 mm



NEW

Art. 717/5/S3
L 25 x H 290 mm
Ø 2 mm



NEW

Art. 717/5/S4
L 25 x H 285 mm
Ø 2 mm



Art. 696/3
H 430 x L 400 mm

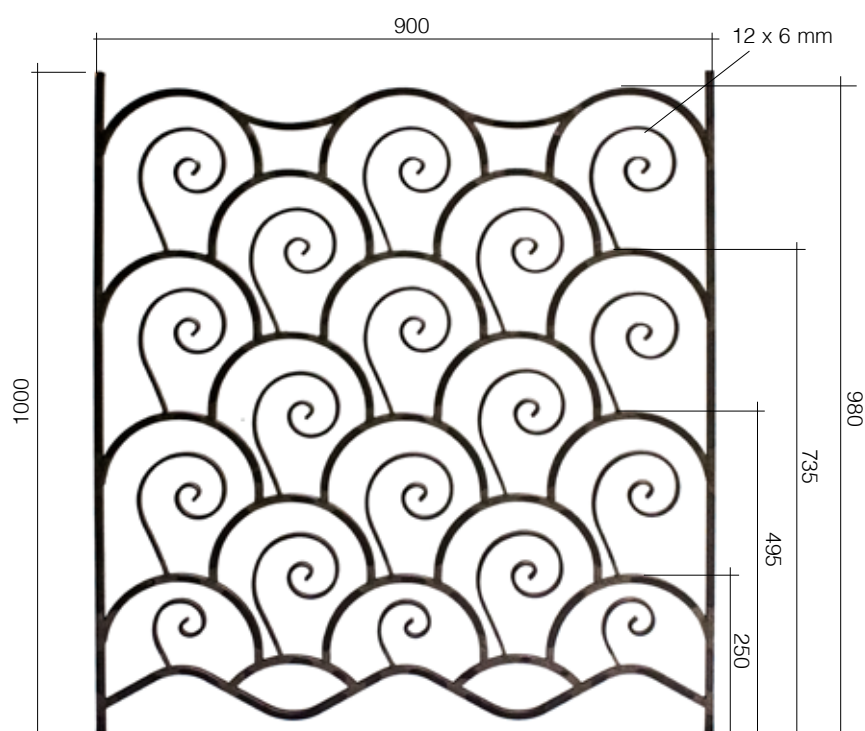

Art. GD291/2
 ⌀ 12 x 12 mm
 900 x 1000 mm



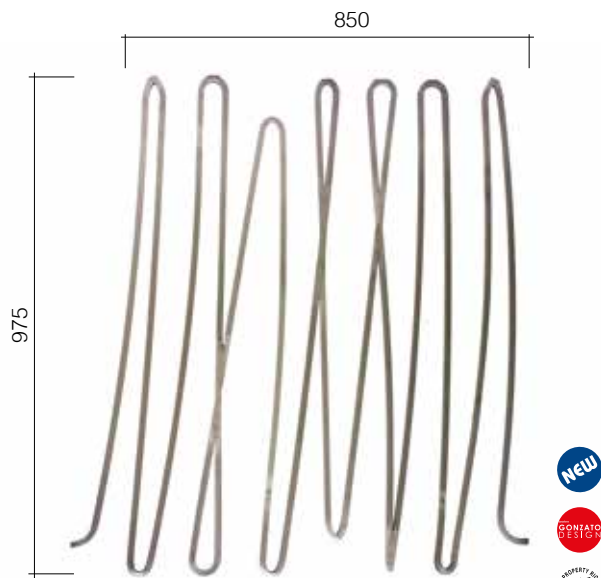

Art. GD300/1
 ∅ 12 x 12 mm
 850 x 975 mm

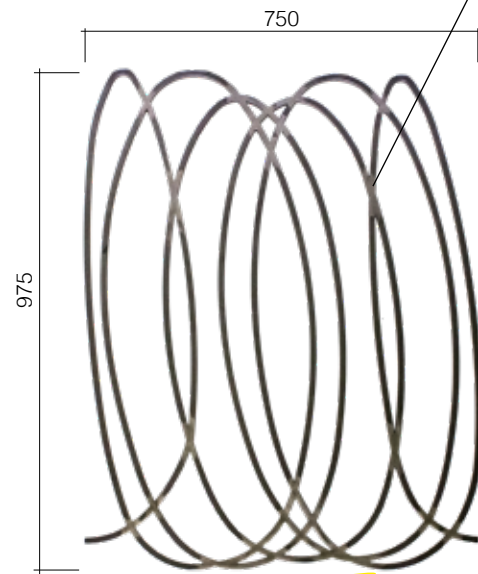

Art. GD300/2
 ∅ 12 x 12 mm
 750 x 975 mm

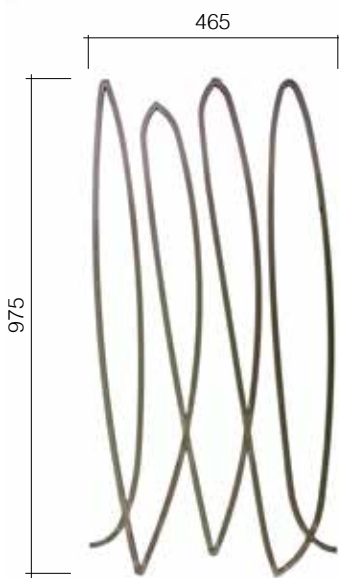

Art. GD300/3
 ∅ 12 x 12 mm
 465 x 975 mm



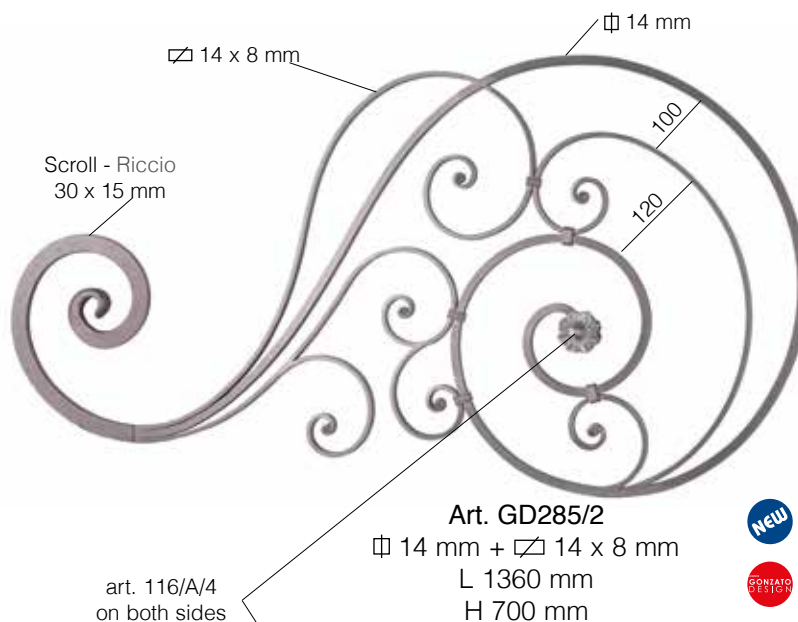
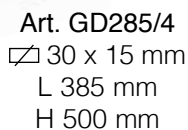
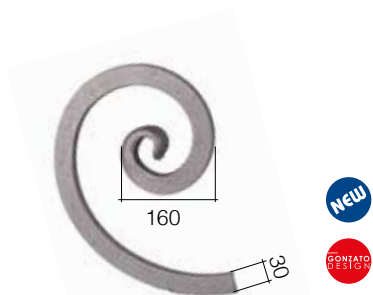
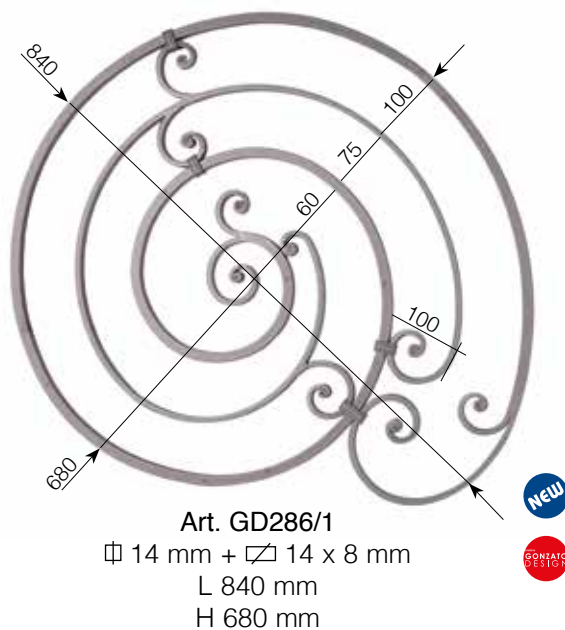
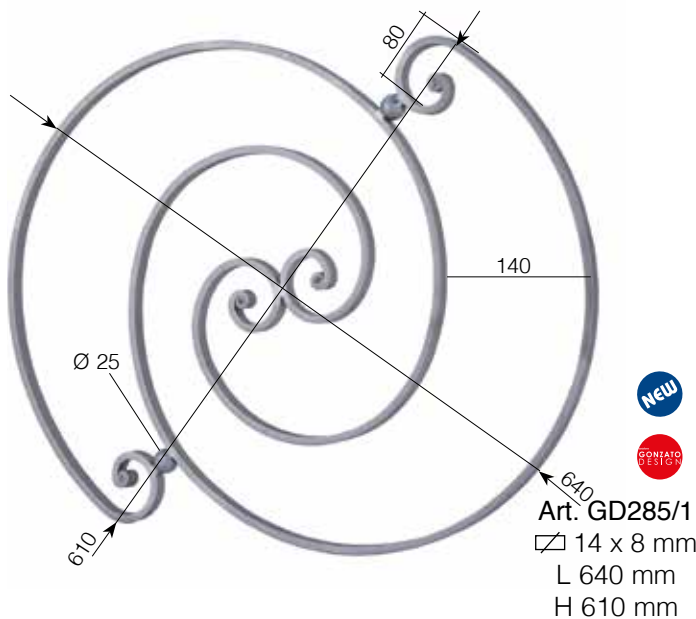

art. 116/A/4
 on both sides
 sui due lati

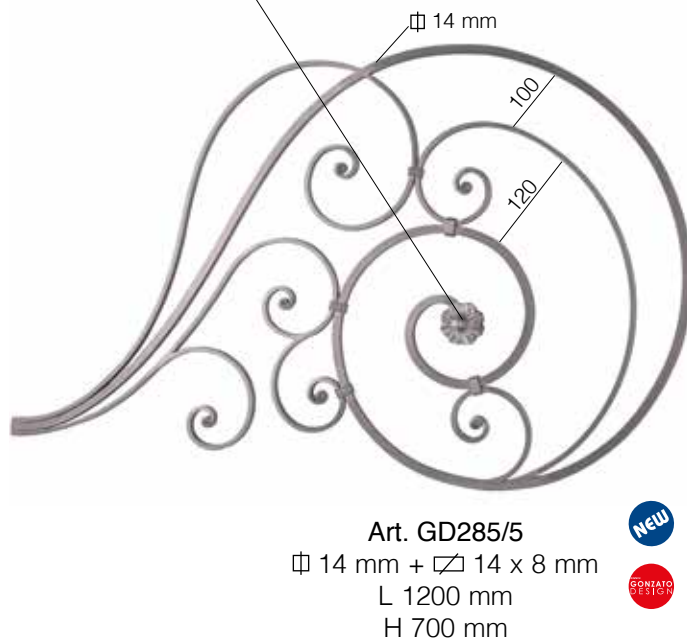

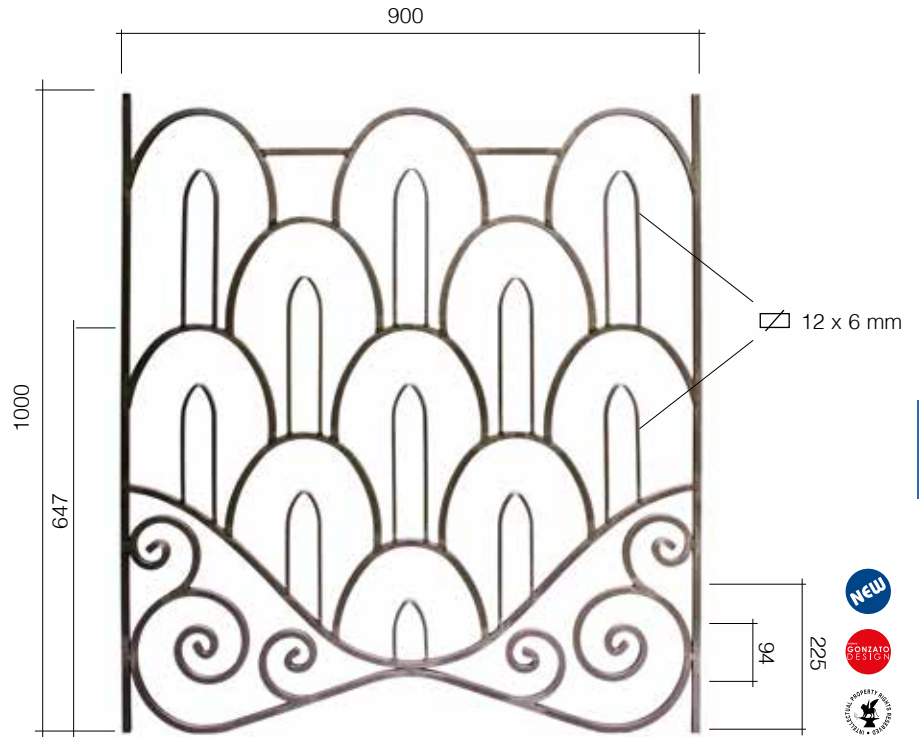

Art. GD291/1
 \square 12 x 12 mm + \square 12 x 6 mm
 900 x 1000 mm

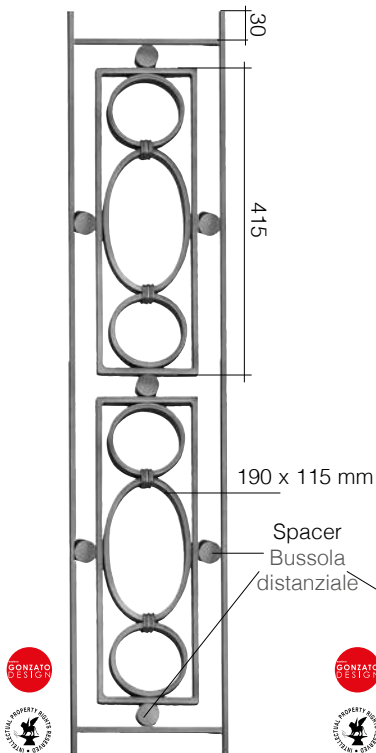

Art. GD205/2
 \square 14 x 8 mm
 210 x 1000 mm

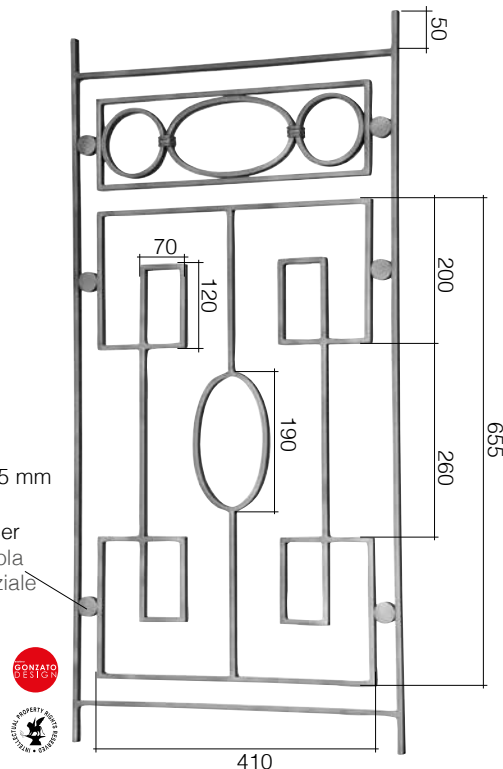

Art. GD205/1
 \square 14 x 8 mm
 495 x 1000 mm

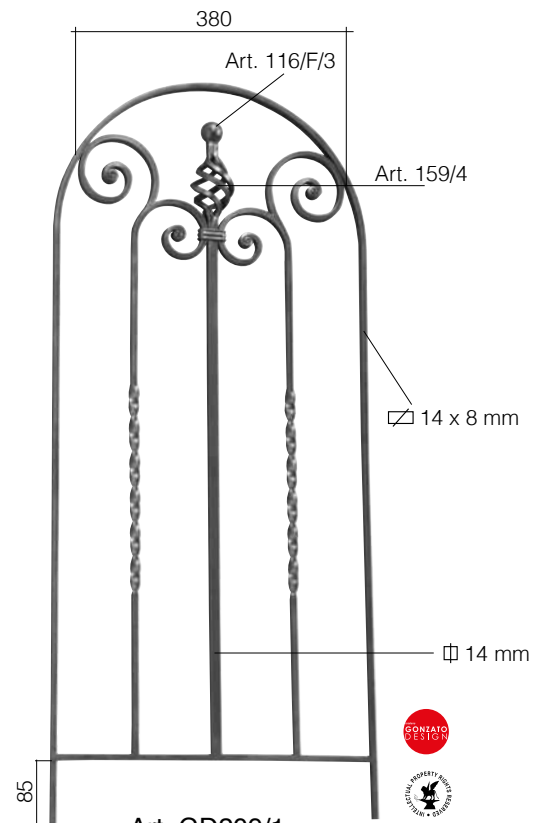

Art. GD209/1
 \square 14 x 8 mm
 440 x 1000 mm

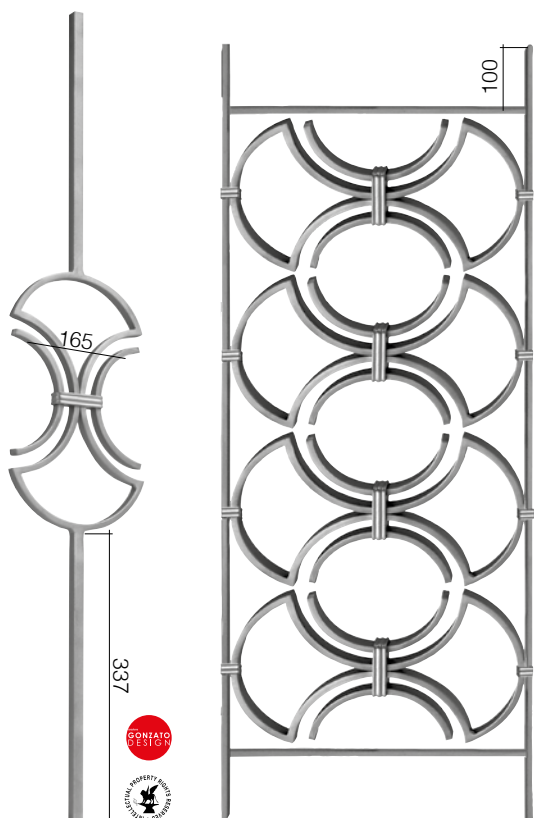

Art. GD187/1
 ∅ 14 mm
 190 x 1000 mm

Art. GD189/2
 ∅ 14 x 8 mm
 340 x 1000 mm

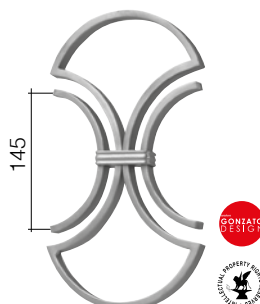

Art. GD187/2
 ∅ 14 x 8 mm
 190 x 325 mm

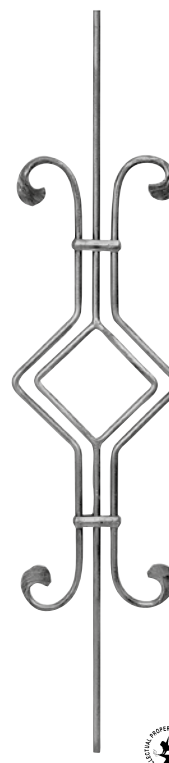

Art. 1074/1
 ∅ 10 mm
 205 x 1000 mm

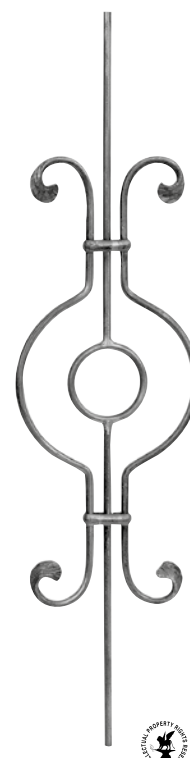

Art. 1074/2
 ∅ 10 mm
 230 x 1000 mm

Tubular steel frame ∅ 25 x 25 mm - Insert iron solid ∅ 12 x 12 mm
 Struttura-telaio tubo ∅ 25 x 25 mm - Inserti ∅ 12 x 12 mm

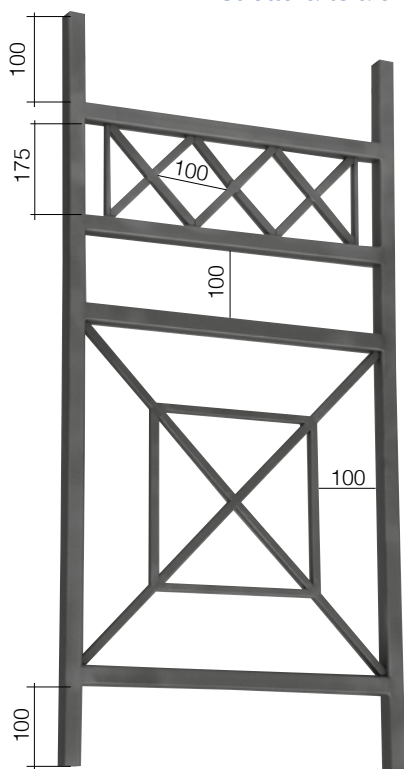

Art. GD76/1
 H 1000 mm
 L 500 mm

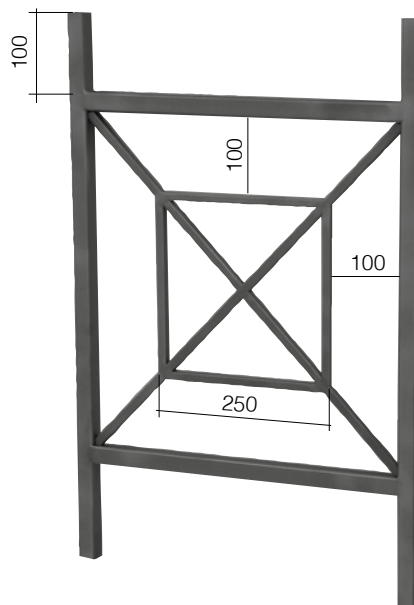

Art. GD76/2
 H 700 mm
 L 500 mm

Rosettes 116/A/4 on both sides - Rosette 116/A/4 sui 2 lati

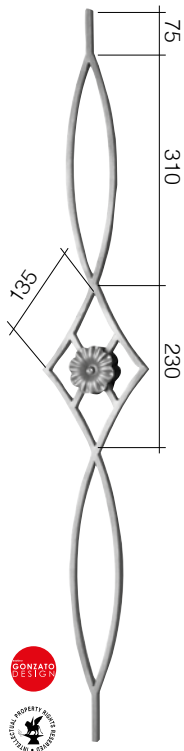

Art. GD16/2
 14 x 8 mm
 160 x 1000 mm

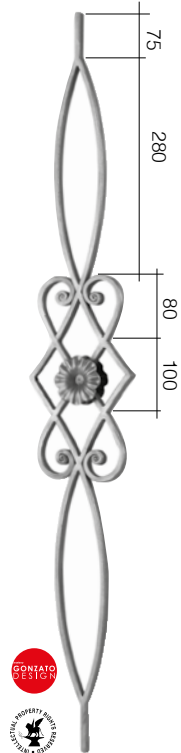

Art. GD16/1
 14 x 8 mm
 160 x 1000 mm

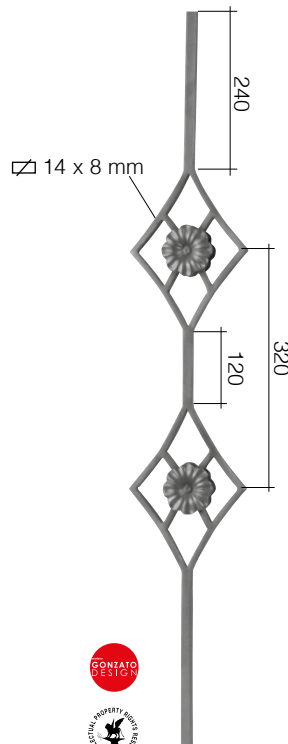

Art. GD18/1
 14 mm
 160 x 1000 mm

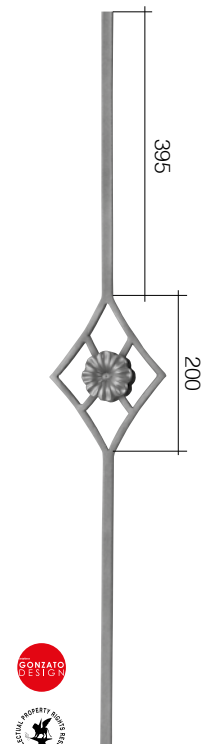

Art. GD18/2
 14 mm
 160 x 1000 mm

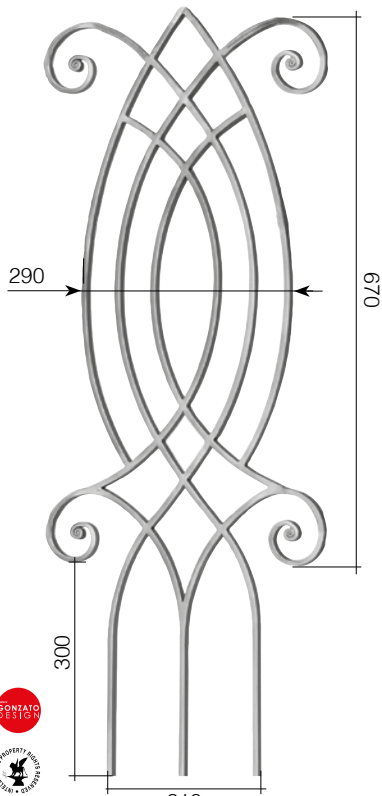

Art. GD234/1
 14 x 8 mm
 380 x 1000 mm

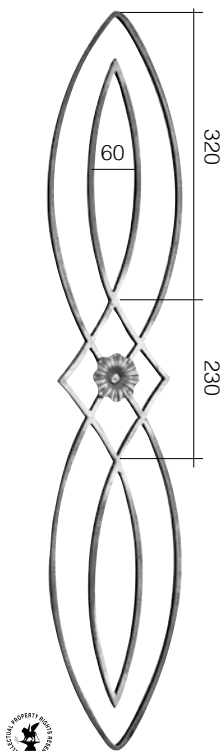

Art. 1680/2
 14 x 8 mm
 190 x 1000 mm

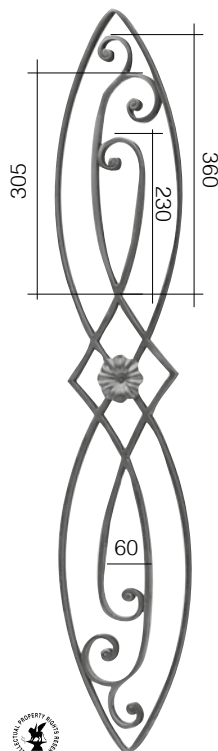

Art. 1681/1
 14 x 8 mm
 190 x 1000 mm



Ornaments - Ornamenti \varnothing 12 x 6 mm

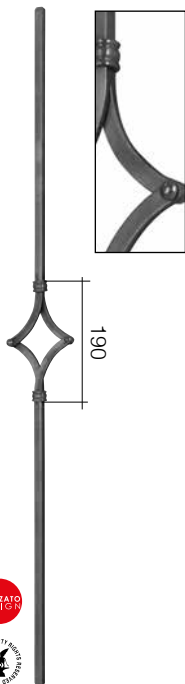

Art. GD20/1 **BEST PRICE**
 \varnothing 12 mm
 110 x 1000 mm

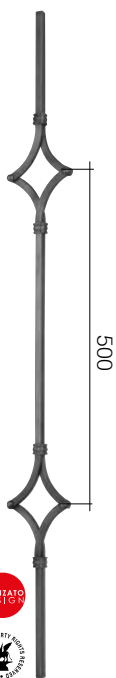

Art. GD20/2
 \varnothing 12 mm
 110 x 1000 mm

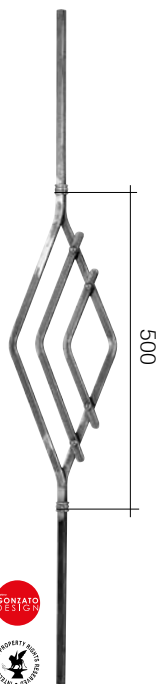

Art. GD20/3
 \varnothing 12 mm
 180 x 1000 mm



Art. GD20/4
 \varnothing 12 mm
 200 x 1000 mm

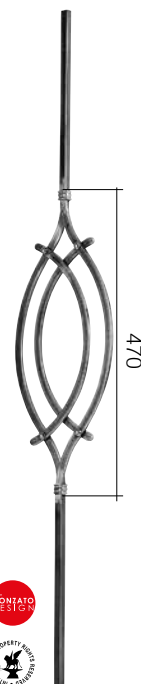

Art. GD20/5
 \varnothing 12 mm
 180 x 1000 mm

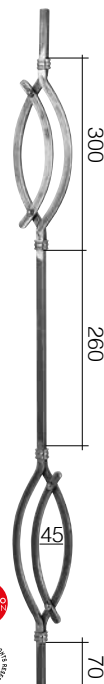

Art. GD20/6
 \varnothing 12 mm
 100 x 1000 mm

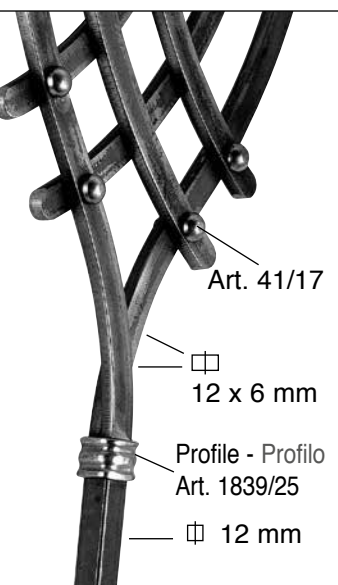

Art. GD20/7
 \varnothing 12 mm
 100 x 1000 mm

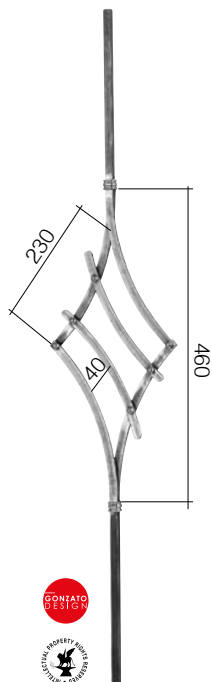

Art. GD20/8
 \varnothing 12 mm
 200 x 1000 mm



Ornaments - Ornamenti \square 12 x 6 mm

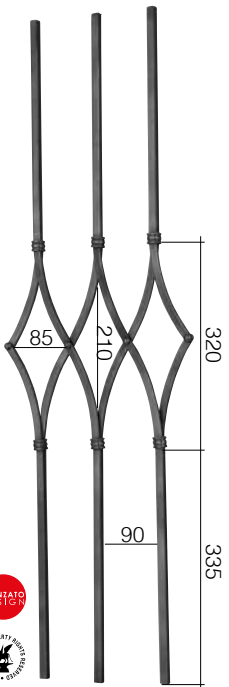

Art. GD21/1
 \square 12 mm
 315 x 1000 mm

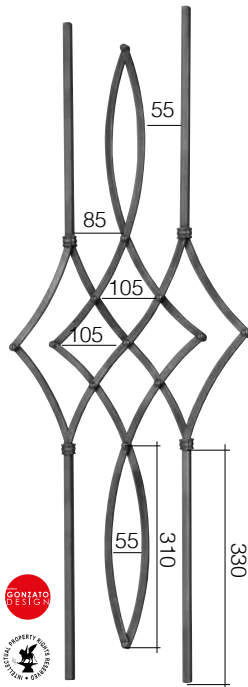

Art. GD21/2
 \square 12 mm
 415 x 1000 mm

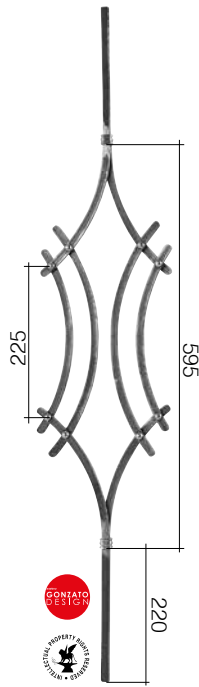

Art. GD21/3
 \square 12 mm
 200 x 1000 mm

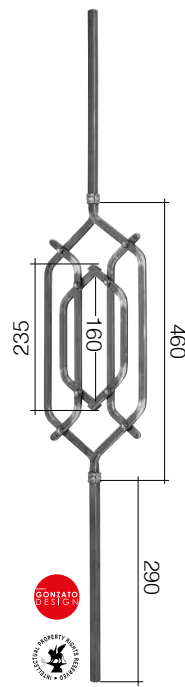

Art. GD21/4
 \square 12 mm
 180 x 1000 mm

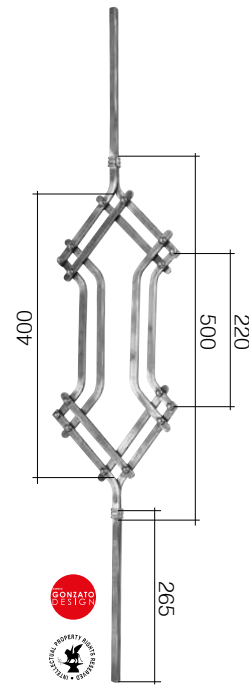

Art. GD21/5
 \square 12 mm
 200 x 1000 mm

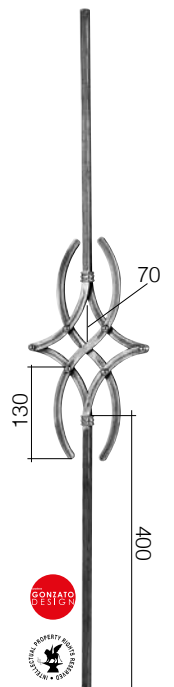

Art. GD21/6
 \square 12 mm
 200 x 1000 mm



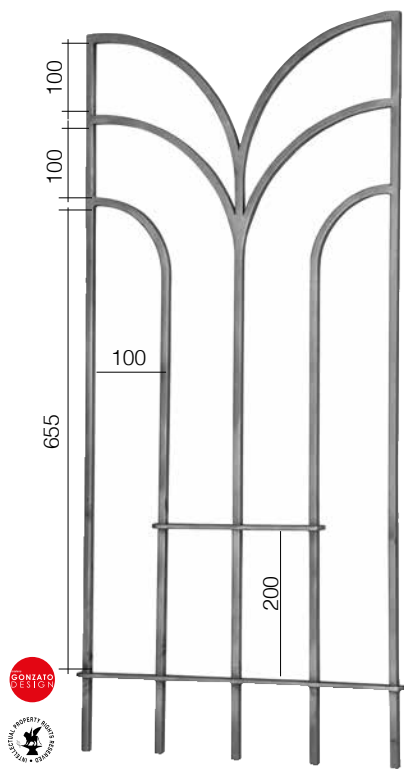

Art. GD68/1
 □ 12 x 12 mm
 480 x 1000 mm

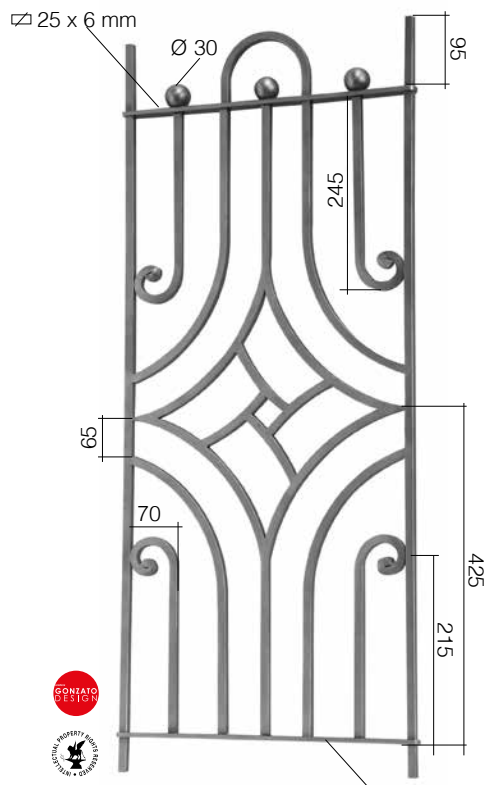

Art. GD212/1 □ 25 x 6 mm
 □ 12 x 12 mm
 420 x 1000 mm

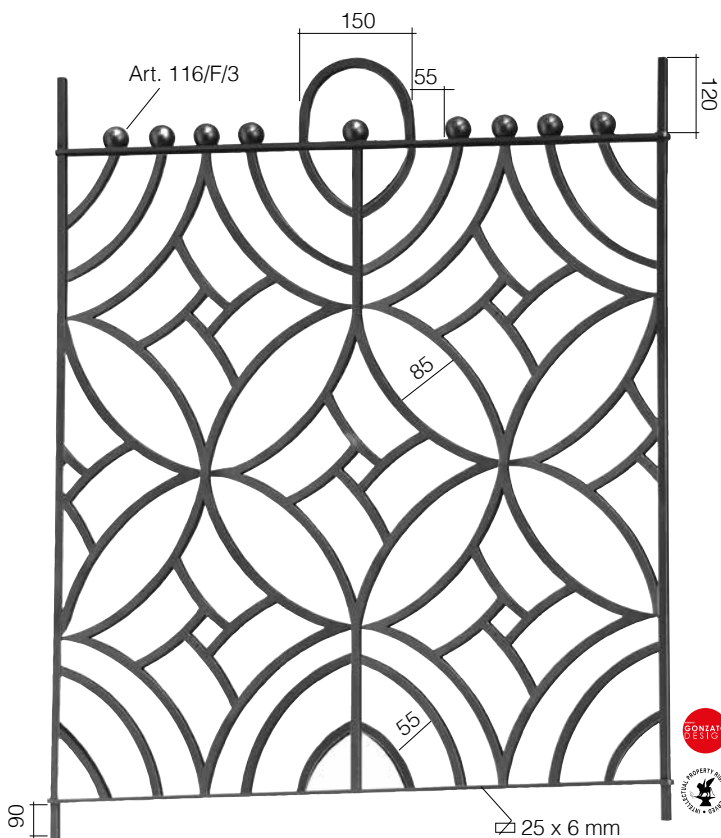

Art. GD211/1
 □ 12 x 12 mm
 830 x 1000 mm

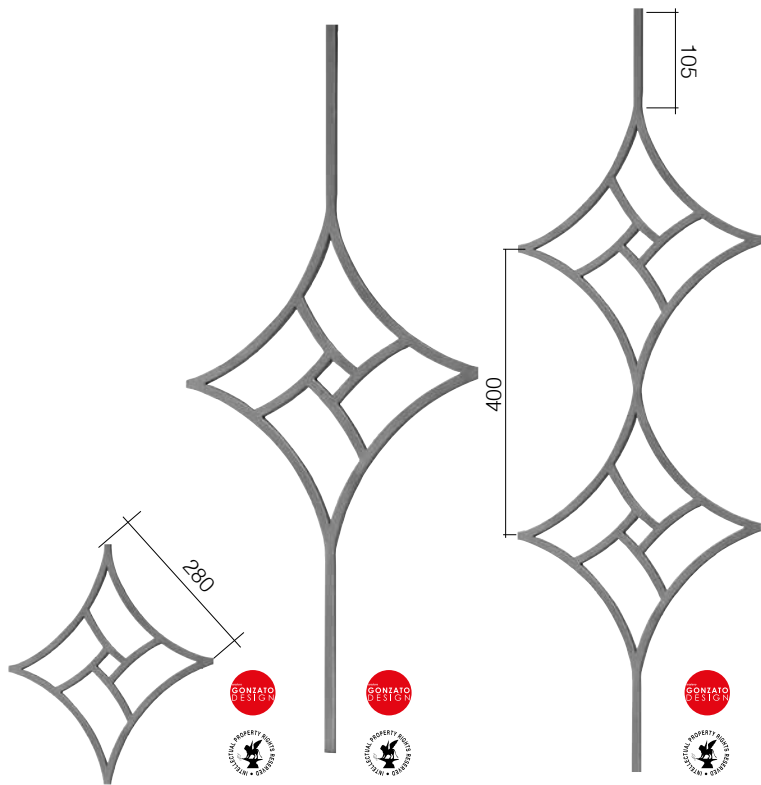

Art. GD211/2
 □ 12 mm
 395 x 395 mm

Art. GD211/3
 □ 12 mm
 395 x 1000 mm

Art. GD211/4
 □ 12 mm
 395 x 1000 mm

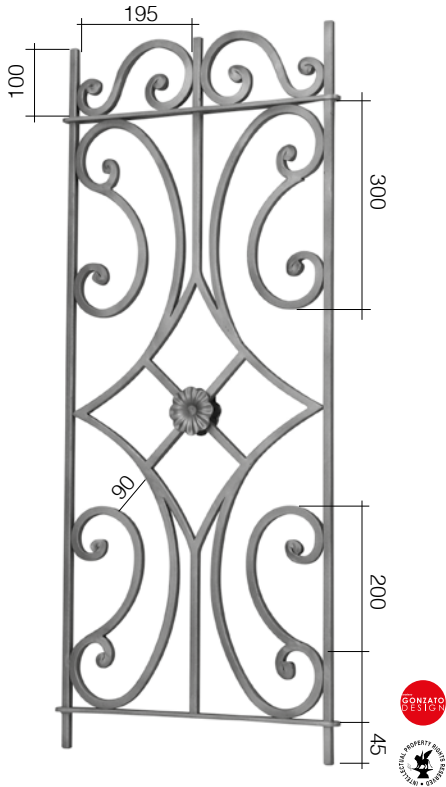

Art. GD61/1
 Ø 12 x 12 mm
 430 x 1000 mm

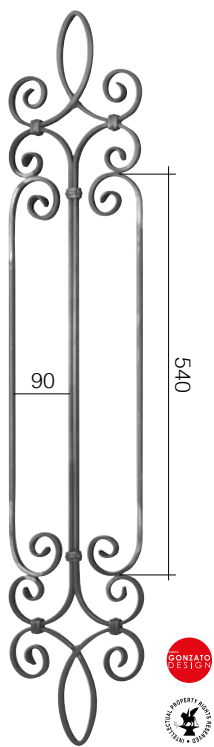

Art. GD35/2
 Ø 12 x 6 mm
 200 x 1000 mm

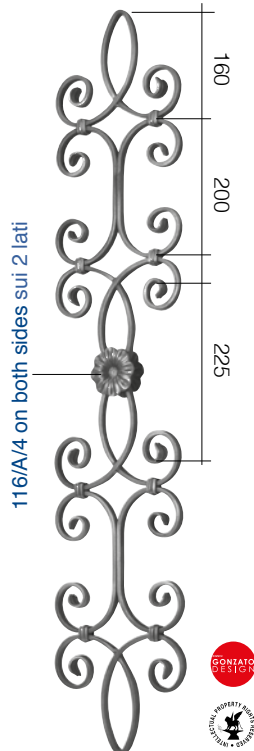

Art. GD35/1
 Ø 12 x 6 mm
 200 x 1000 mm

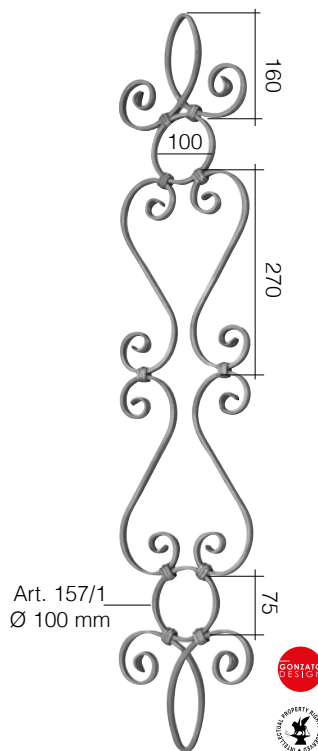

Art. GD35/3
 Ø 12 x 6 mm
 200 x 1000 mm

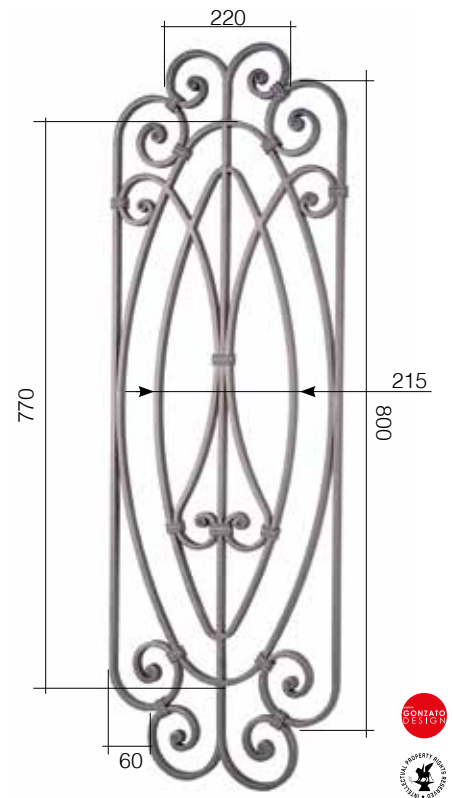

Art. GD284/1
 Ø 14 x 8 mm
 350 x 1000 mm

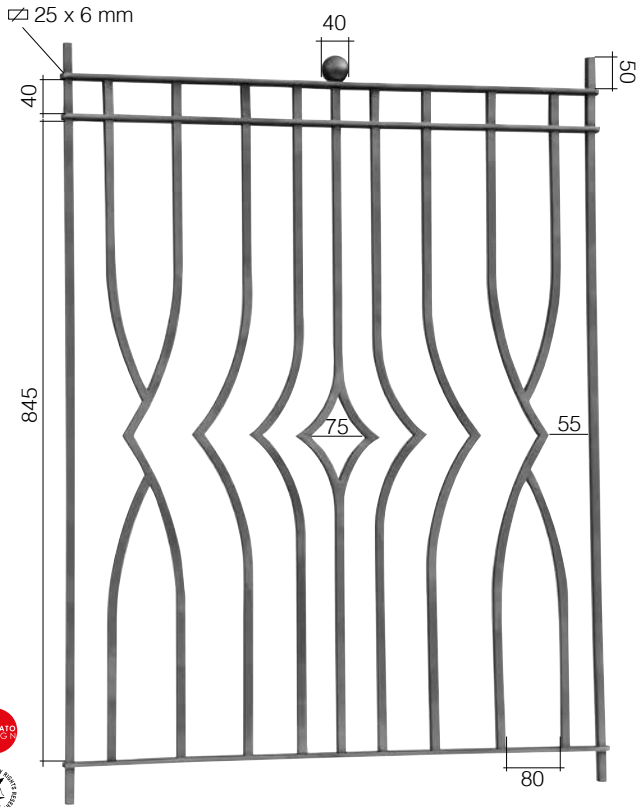

Art. GD232/1
 ⌀ 12 x 12 mm
 740 x 1000 mm

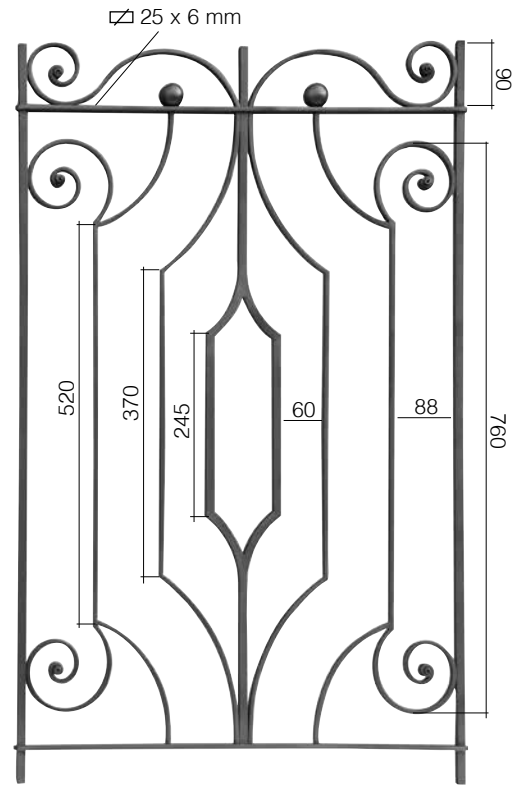

Art. GD242/1
 ⌀ 12 x 12 mm
 640 x 1000 mm



116/A/4 on both sides sui 2 lati

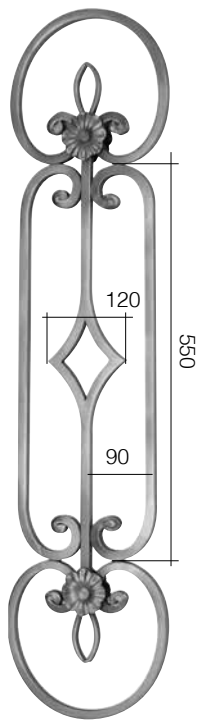

Art. GD31/1
 ⌀ 14 x 14 mm
 245 x 1000 mm

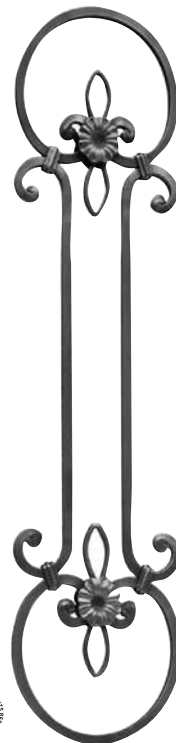

Art. 1682/1
 ⌀ 14 x 14 mm
 245 x 1000 mm

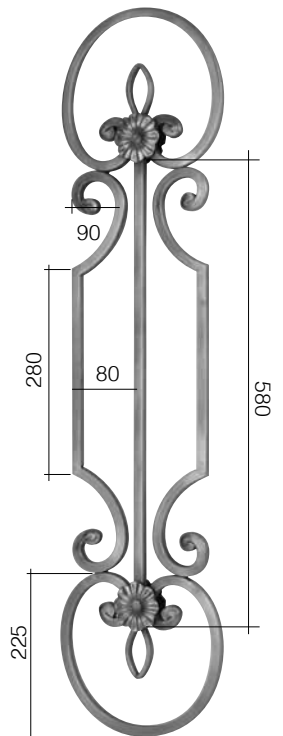

Art. GD31/2
 ⌀ 14 x 14 mm
 245 x 1000 mm

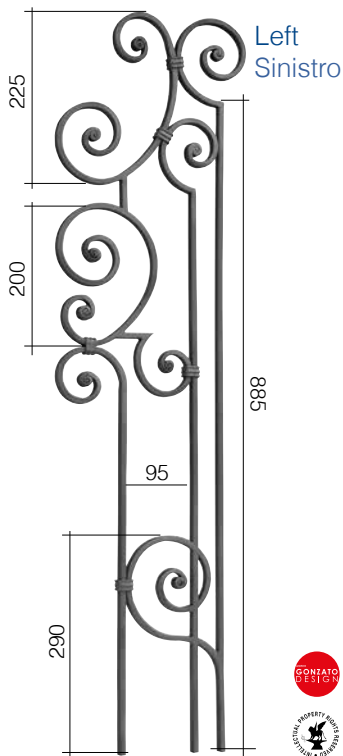

Left
Sinistro

left - sinistro
Art. GD163/2
□ 14 x 8 mm
L 280 mm
H 1000 mm

right - destro
Art. GD163/1
□ 14 x 8 mm
L 280 mm
H 1000 mm

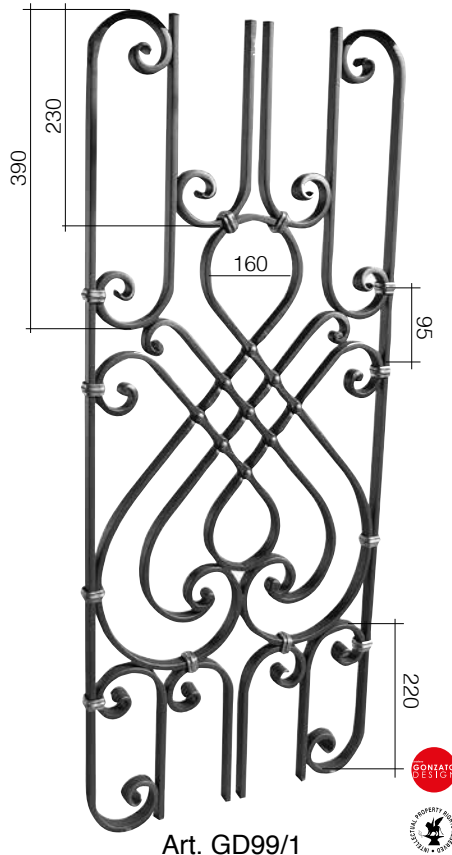

Art. GD99/1
□ 16 x 8 mm
420 x 1000 mm

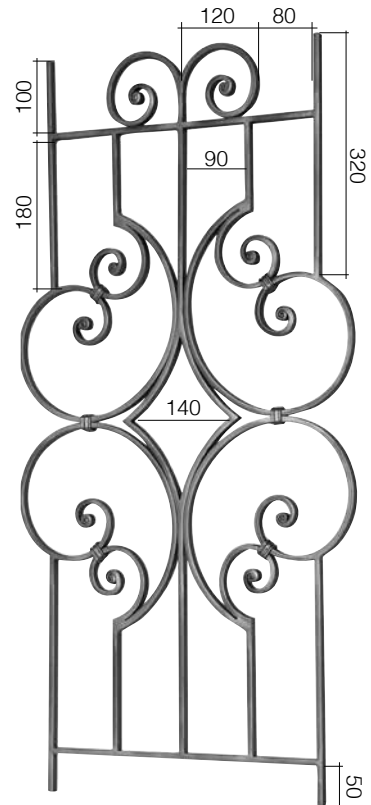

Art. GD219/1
□ 14 x 8 mm
500 x 1000 mm



Art. GD236/1
 □ 14 x 8 mm
 970 x 1000 mm

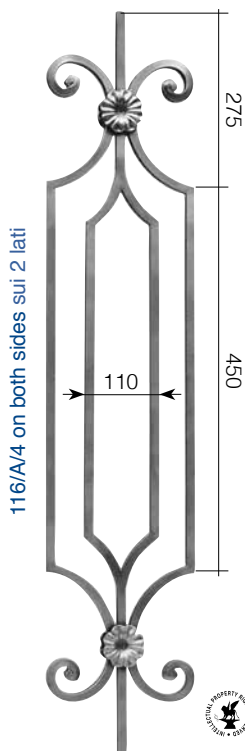

Art. 1685/3
 □ 14 x 14 mm
 230 x 1000 mm

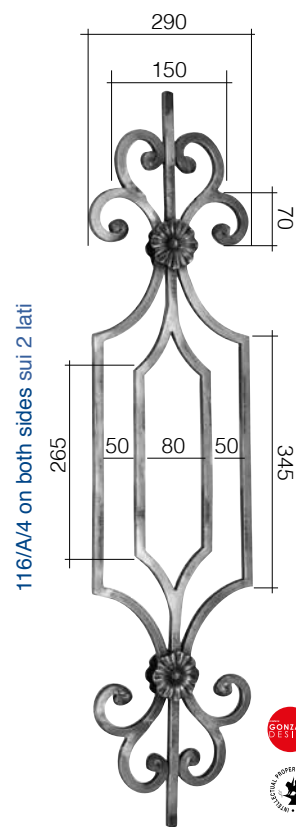

Art. GD22/1
 □ 14 x 14 mm
 230 x 1000 mm

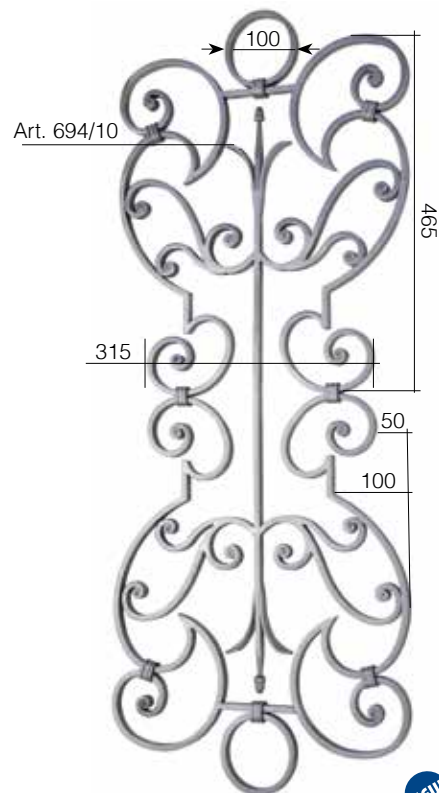

Art. GD282/2
 □ 14 x 8 mm
 405 x 1010 mm



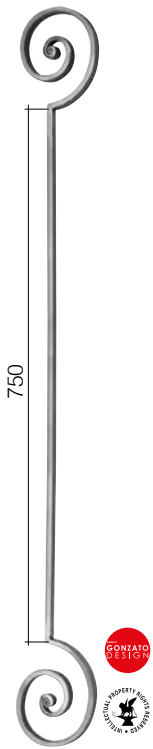

Art. GD175/1
 □ 14 x 8 mm
 H 1000 mm
 L 115 mm

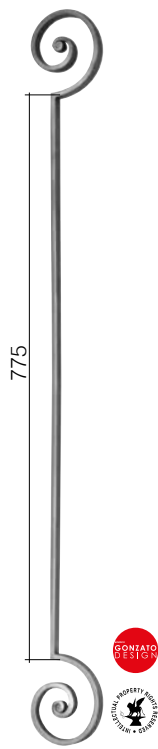

Art. GD175/2
 □ 14 x 8 mm
 H 1000 mm
 L 105 mm

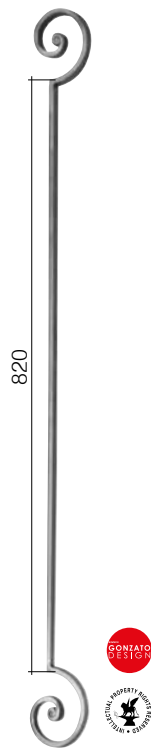

Art. GD175/3
 □ 14 x 8 mm
 H 1000 mm
 L 80 mm

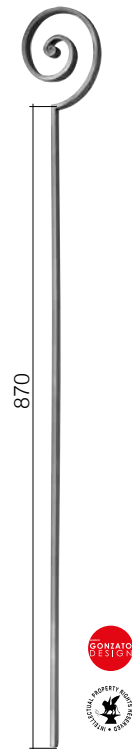

Art. GD175/4
 □ 14 x 8 mm
 H 1000 mm
 L 115 mm

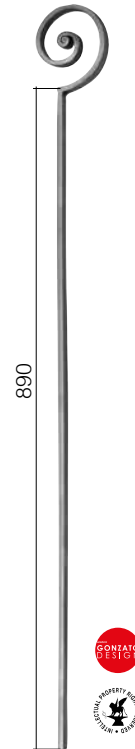

Art. GD175/5
 □ 14 x 8 mm
 H 1000 mm
 L 105 mm

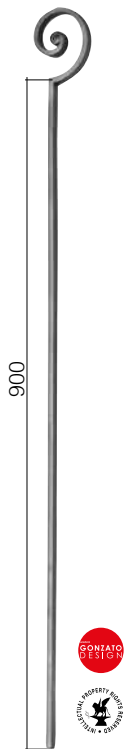

Art. GD175/6
 □ 14 x 8 mm
 H 1000 mm
 L 85 mm

BEST PRICE

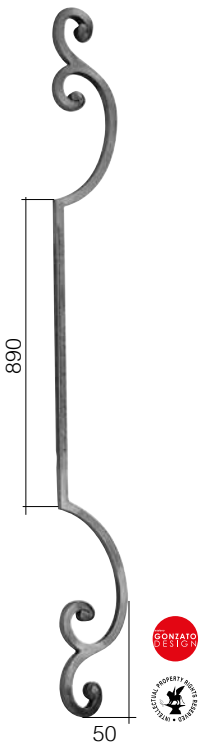

Art. GD22/3
 Φ 14 x 14 mm
 110 x 1000 mm



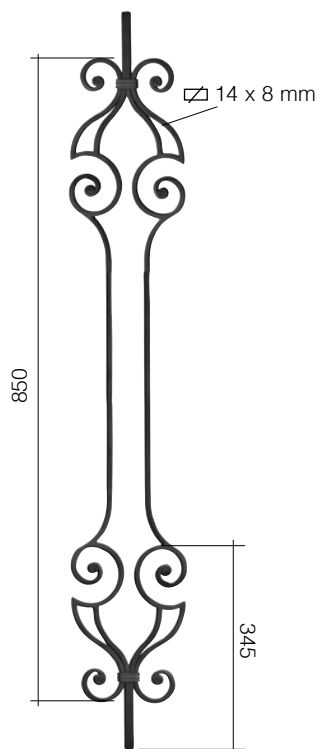

Art. GD150/2
 Ø 14 x 14 mm
 205 x 1000 mm

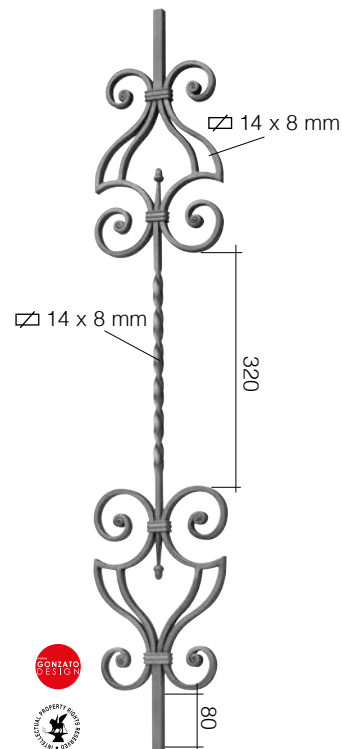

Art. GD150/3
 Ø 14 x 14 mm
 205 x 1000 mm

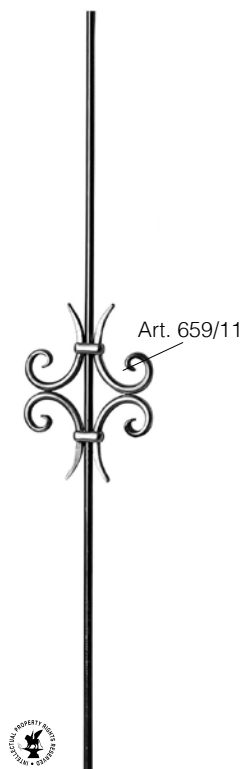

Art. 1066/5
 Ø 12 mm
 180 x 1000 mm



Art. 1066/4
 Ø 12 mm
 180 x 1000 mm

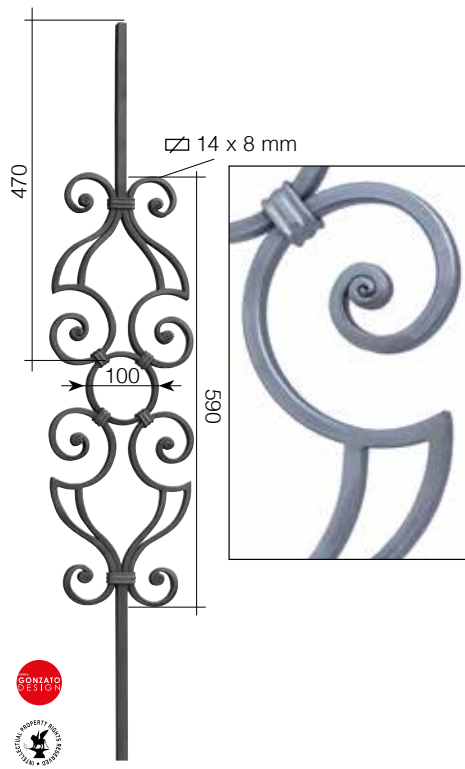

Art. GD151/1
 Ø 14 x 14 mm
 205 x 1000 mm

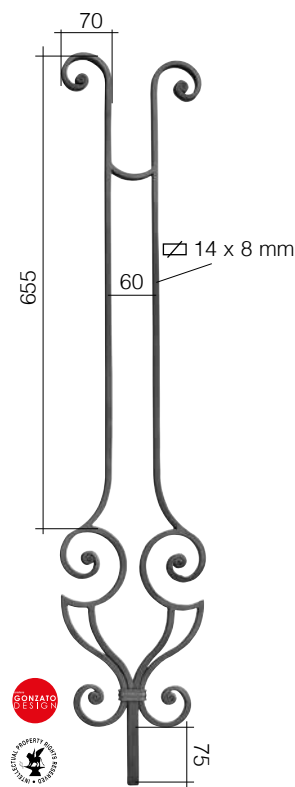

Art. GD148/1
 Ø 14 x 14 mm
 205 x 1000 mm

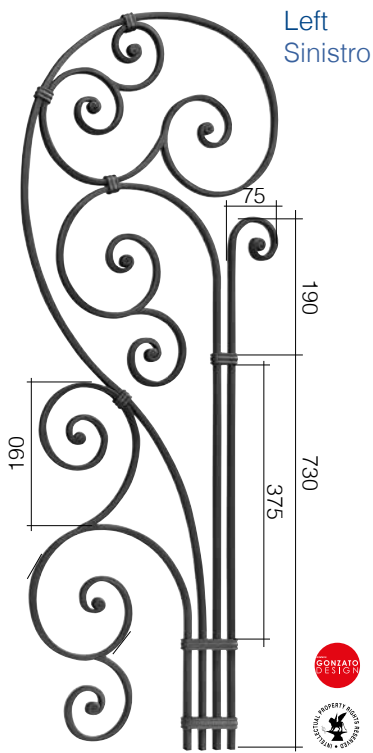

left - sinistro
Art. GD164/1
Ø 14 x 8 mm
L 380 mm
H 1000 mm

right - destro
Art. GD164/2
Ø 14 x 8 mm
L 380 mm
H 1000 mm

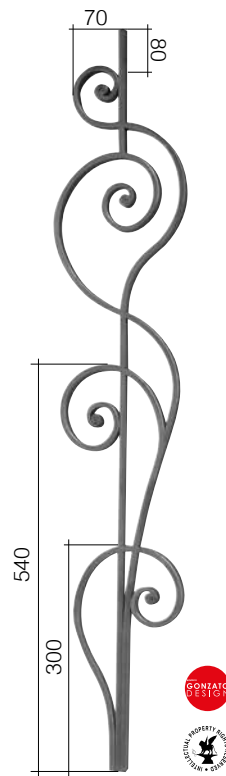

Art. GD228/2
Ø 14 x 8 mm
190 x 1000 mm

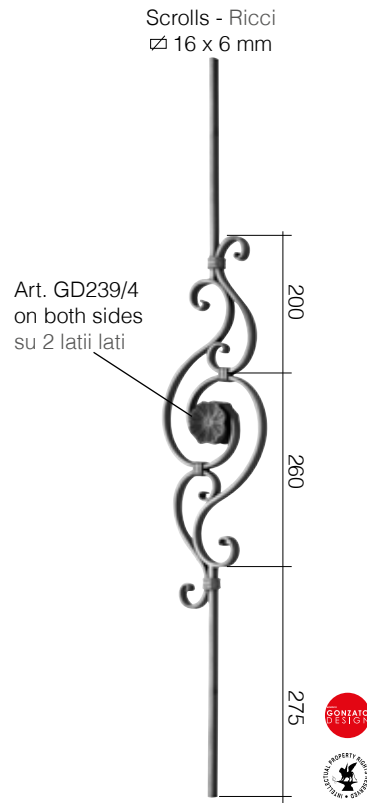

Art. GD271/5
Ø 16 x 8 mm
175 x 1000 mm

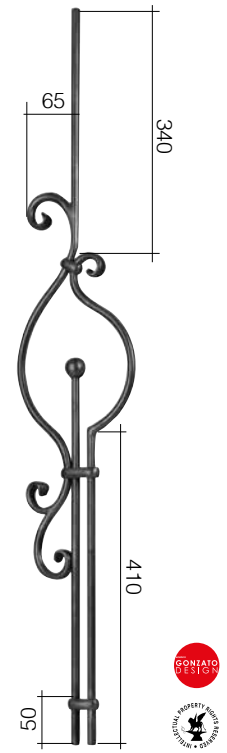

Art. GD39/3
Ø 12 mm
190 x 1000 mm

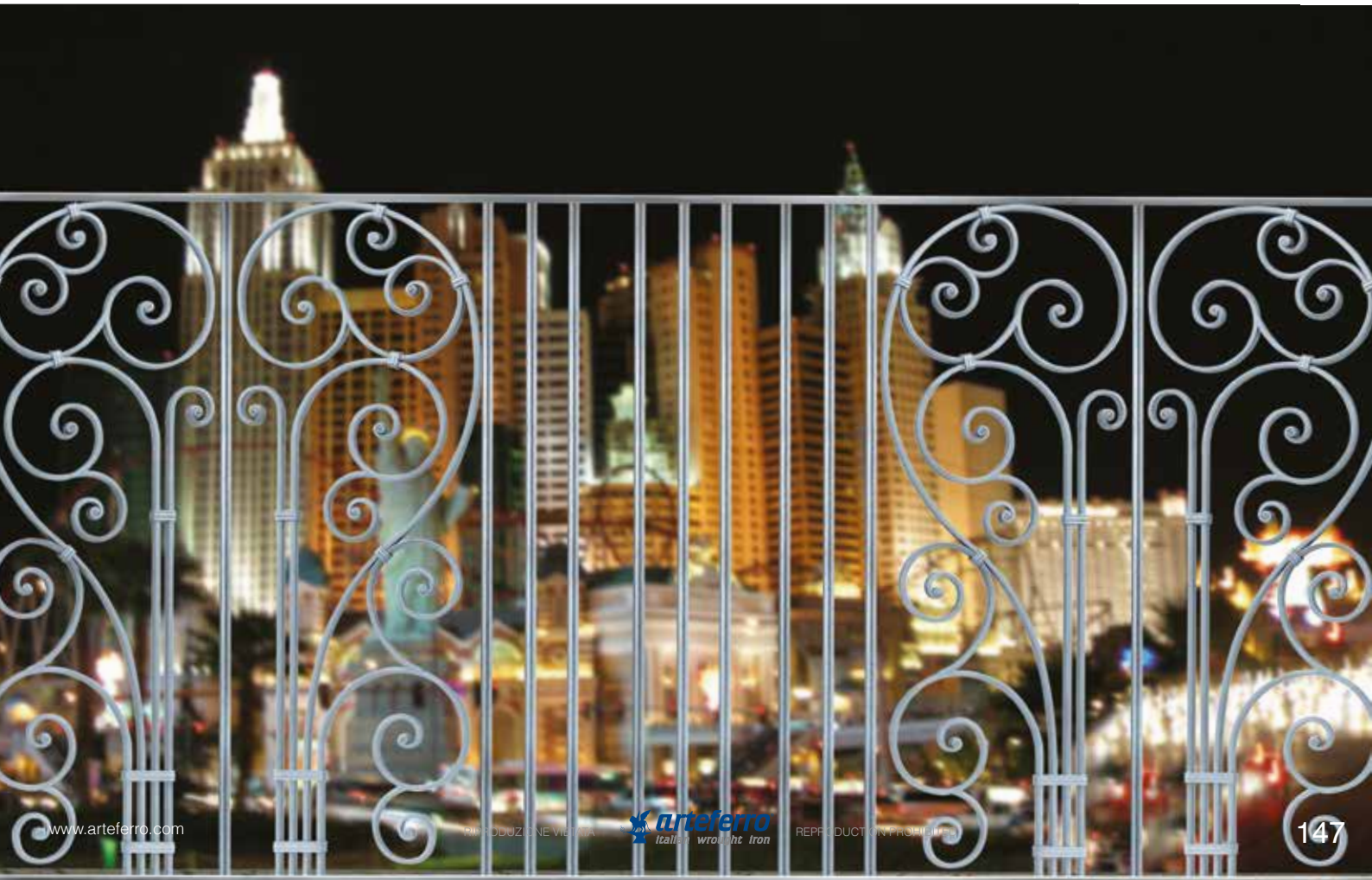

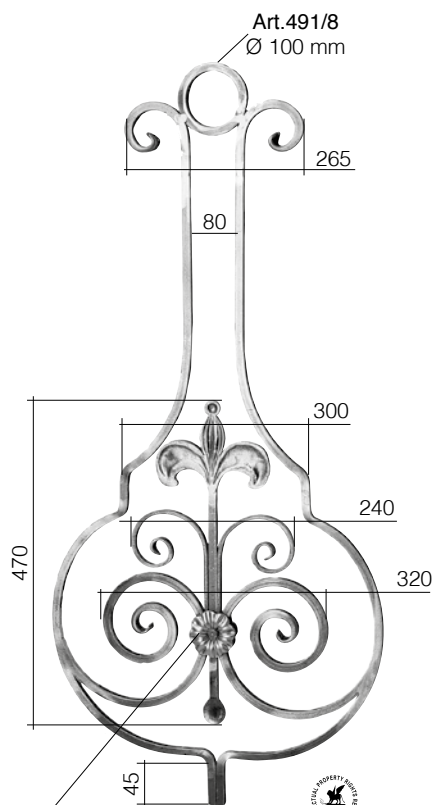

Art.491/8
Ø 100 mm

Art.116/A/4
on the two sides
sui due lati

Art. 1043/2
Ø 12 x 12 mm
490 x 1030 mm

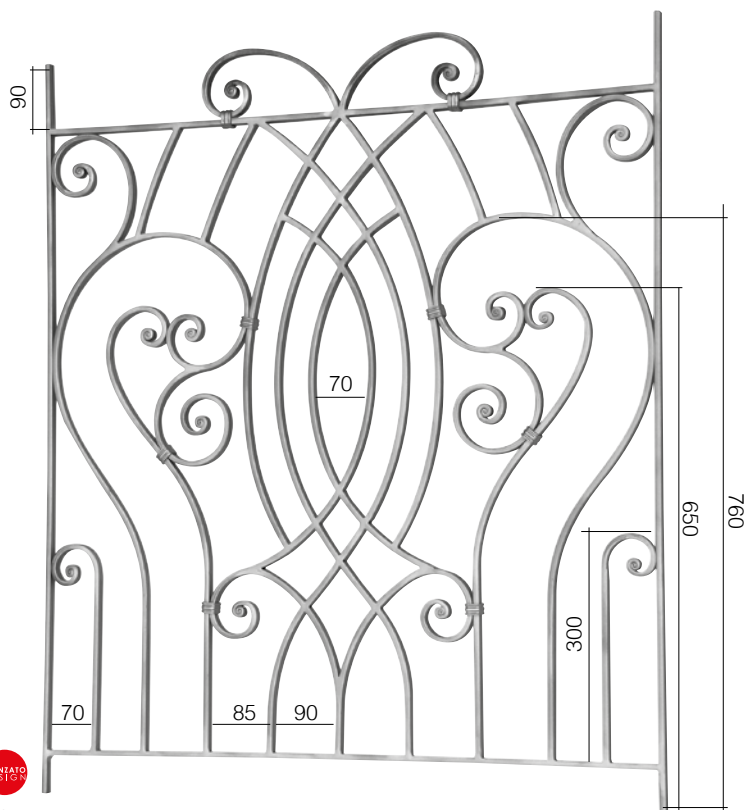

Art. GD235/1
Ø 14 x 8 mm
890 x 1000 mm

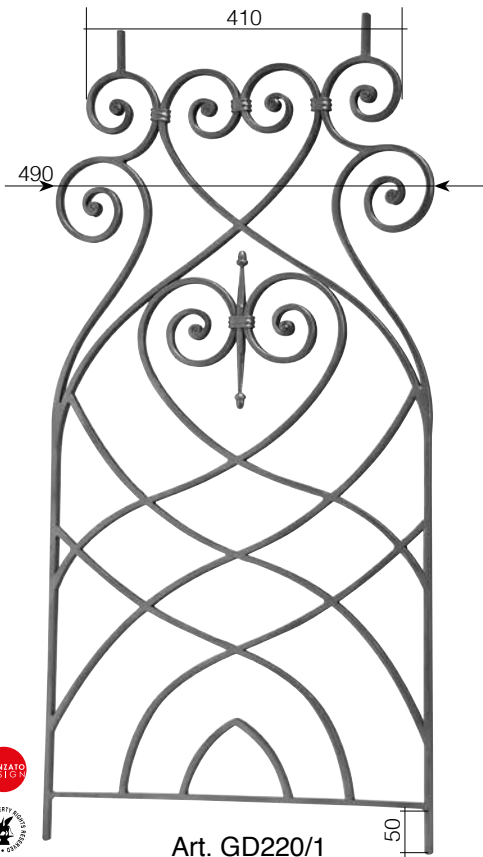

Art. GD220/1
 ∅ 14 x 8 mm
 500 x 1000 mm

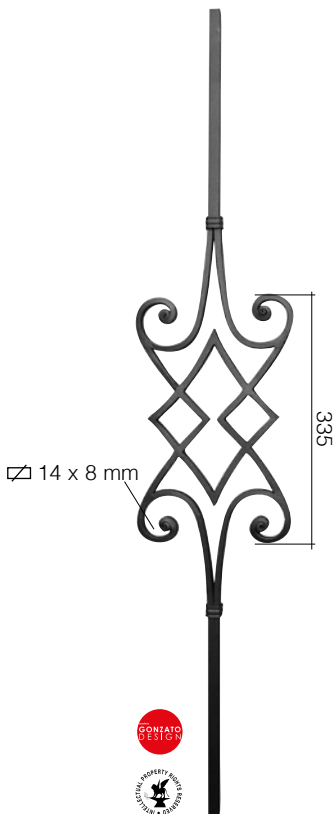

Art. GD154/3
 ∅ 14 mm
 190 x 1000 mm





Art. 700/4/C/2



Art. GD158/1
 ∅ 14 x 8 mm
 160 x 1000 mm

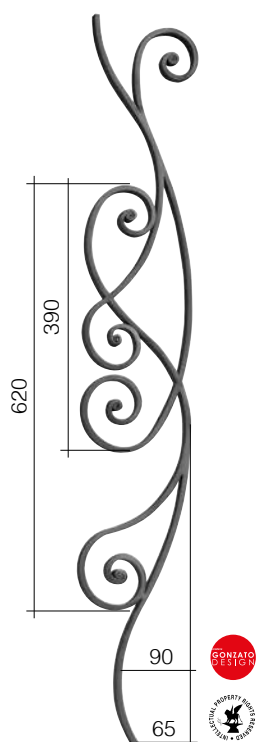

Art. GD158/2
 ∅ 14 x 8 mm
 160 x 1000 mm

BEST PRICE

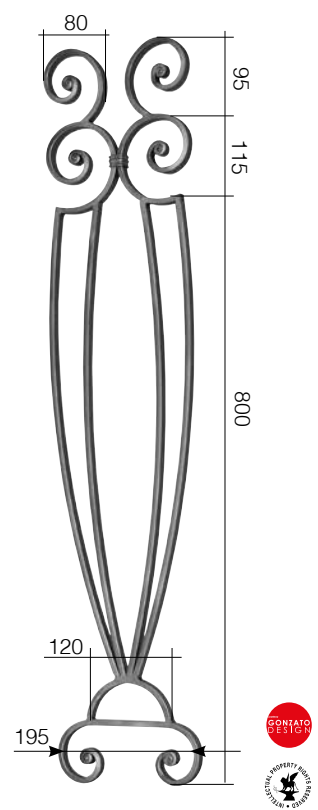

Art. GD175/7
 ∅ 14 x 8 mm
 200 x 1000 mm





Arteferro bowed pickets are elegant elements that allow you to create railings, fences or curved balustraded. Also made with patterns that reflect those of the pickets and panels, they can therefore be combined with each other to create compositions of refined elegance.

I pancioni Arteferro sono degli eleganti elementi che consentono di creare inferriate, recinzioni o parapetti bombati. Realizzati anche con motivi che riprendono quelli dei paletti e dei pannelli, possono quindi essere abbinati tra loro per realizzare composizioni dalla ricercata eleganza.

BOWED PICKETS

PANCIONI



Pag. 72

See also forged pickets

Vedi anche i paletti forgiati



FORGED - FORGIATI



Art. 1783/1
 \varnothing 14 x 14 mm
 H 1000 mm



Art. 1783/2
 \varnothing 14 x 14 mm
 H 1000 mm

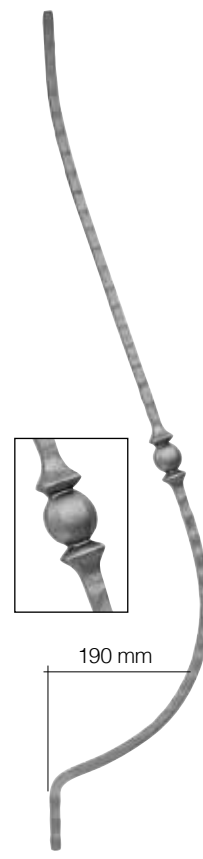

Art. 1783/5
 \varnothing 12 x 12 mm
 H 1000 mm

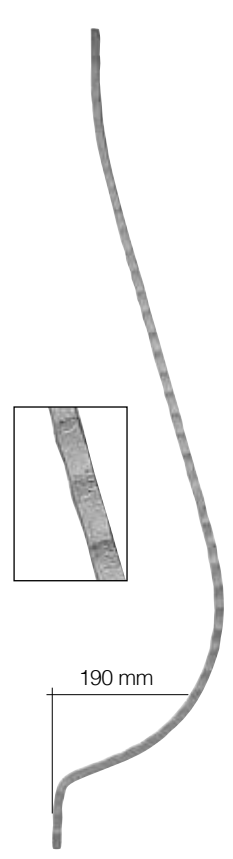

Art. 1783/6
 \varnothing 12 x 12 mm
 H 1000 mm

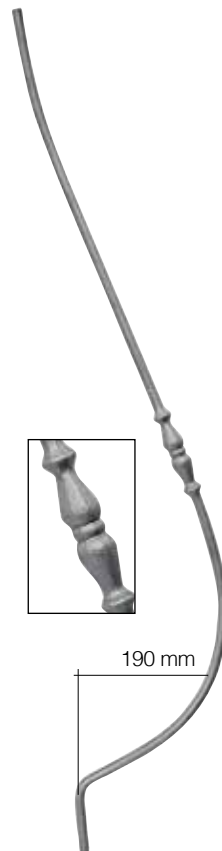

Art. 1783/3
 \varnothing 12 mm
 H 1000 mm

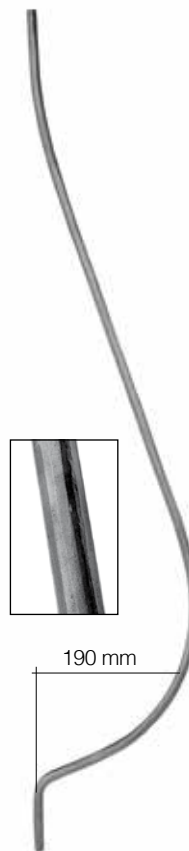

Art. 1783/4
 \varnothing 12 mm
 H 1000 mm



Art. 1783/7
 \varnothing 12 mm
 H 1000 mm

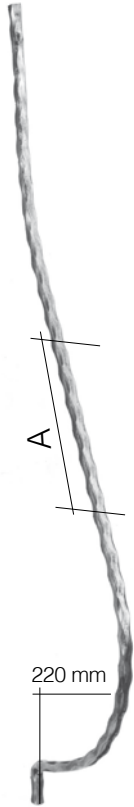

| Height Altezza | Section Sezione | Art. | Art. | A Central twists Attorcigliat. centrale | A Hammered with one stamp Spigolato con schiacciata | A Hammered with basket Spigolato con pigna |
|-------------------|--------------------|-------|--------|---|---|--|
| H 900 mm | Φ 12 x 12 mm | 47/15 | 47/6 | 47/3 | 572/5 | 47/5 |
| | Φ 14 x 14 mm | 47/16 | 47/12 | 47/9 | 572/7 | 47/11 |
| | Ø 12 mm | 47/25 | - | - | - | - |
| | Ø 14 mm | 47/26 | - | - | - | - |
| | Ø 16 mm | 47/27 | - | - | - | - |
| H 1000 mm | Φ 12 x 12 mm | 47/17 | 47/14 | 47/3/1000 | - | 47/13 |
| | Φ 14 x 14 mm | 47/18 | 47/20 | 47/22 | - | 47/23 |
| | Ø 12 mm | 47/28 | - | - | - | - |
| | Ø 14 mm | 47/19 | - | - | - | - |
| | Ø 16 mm | - | - | - | - | - |
| H 1200 mm | Φ 12 x 12 mm | 47/29 | 47/24 | 47/35 | 572/6 | - |
| | Φ 14 x 14 mm | - | 1158/5 | - | 572/8 | 1158/6 |
| | Ø 12 mm | - | - | - | - | - |
| | Ø 14 mm | 47/30 | - | - | - | - |
| | Ø 16 mm | 47/31 | - | - | - | - |
| H 1500 mm | Φ 12 x 12 mm | 47/32 | - | 47/36 | - | - |
| | Φ 14 x 14 mm | - | - | - | - | - |
| | Ø 12 mm | - | - | - | - | - |
| | Ø 14 mm | 47/33 | - | - | - | - |
| | Ø 16 mm | 47/34 | - | - | - | - |



Infill elements
for bowed
pickets
Elementi di
tamponamento
per pancioni



Hot forged ends
Terminali fucinati
a caldo

| Section Sezione | L 150 mm H 350 mm Art. | L 150 mm H 350 mm Art. | L 180 mm H 360 mm Art. | L 180 mm H 360 mm Art. |
|--------------------|------------------------------|------------------------------|------------------------------|------------------------------|
| Φ 12 x 12 mm | 1308/12 | - | 1308/1 | 1308/3 |
| Φ 14 x 14 mm | 1308/13 | - | 1308/2 | 1308/4 |
| Ø 14 mm | - | 1308/8 | 1308/11 | - |
| Ø 16 mm | - | 1308/9 | 1308/7 | - |

*Stamped like
Stampata
Art. 134/2

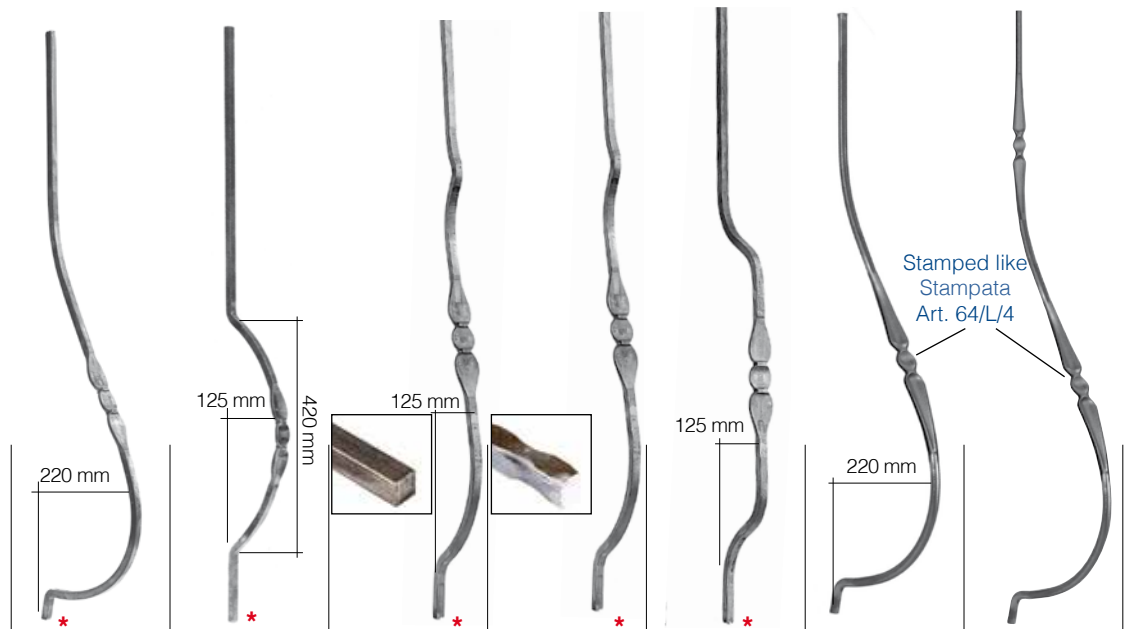

| Height Altezza | Section Sezione | Art. | Art. | Art. | Art. | Art. | Art. | Art. |
|-------------------|--------------------|--------|------------|--------|--------|--------|--------|--------|
| H 830 mm | Φ 12 x 12 mm | - | - | - | - | - | - | - |
| | Φ 14 x 14 mm | - | - | - | 587/13 | - | - | - |
| H 900 mm | Φ 12 x 12 mm | - | - | - | - | - | - | - |
| | Φ 14 x 14 mm | 586/15 | - | - | - | - | - | - |
| H 1000 mm | Φ 12 x 12 mm | 586/6 | 586/8 | 587/12 | - | - | - | - |
| | Φ 14 x 14 mm | 586/7 | 586/9 | - | - | 587/24 | - | - |
| H 1500 mm | Φ 12 x 12 mm | - | - | - | - | - | - | - |
| | Φ 14 x 14 mm | - | 586/9/1500 | - | - | - | - | - |
| H 1000 mm | Ø 12 mm | 586/12 | 586/10 | - | - | - | - | - |
| | Ø 14 mm | 586/13 | 586/11 | - | - | - | 586/16 | 586/17 |



Pag.
80

Take a look
at our stamped
pickets

Vai a vedere i
paletti con
schiacciata

| | | | | | |
|--------------------|----------|-----------|-----------|-----------|-----------|
| Section Sezione | H 510 mm | H 1000 mm | H 1000 mm | H 1200 mm | H 1000 mm |
| Art. | Art. | Art. | Art. | Art. | Art. |
| Φ 12 x 12 mm | 1264/5 | 1270/29 | - | - | - |
| Φ 14 x 14 mm | - | - | 1782/1 | 1158/8 | 1782/9 |

| | | | | | | | |
|--------------------|----------|----------|-----------|----------|-----------|-----------|-----------|
| Section Sezione | H 820 mm | H 900 mm | H 1000 mm | H 910 mm | H 1000 mm | H 1200 mm | H 1500 mm |
| Art. | Art. | Art. | Art. | Art. | Art. | Art. | Art. |
| Φ 12 x 12 mm | - | - | - | - | - | - | - |
| Φ 14 x 14 mm | 70/D/4 | 70/D/5 | 70/D/9 | 1784/1 | 1784/2 | 1784/3 | 1784/4 |
| ▧ 25 x 8 mm | - | 1782/2 | 1782/4 | - | - | - | - |
| ▧ 30 x 8 mm | - | 1782/3 | 1782/5 | - | - | - | - |

| Height Altezza | Section Sezione | Art. |
|-------------------|--------------------|----------|
| H 810 mm | Φ 12 x 12 mm | - |
| | Φ 14 x 14 mm | 1784/5 |
| H 910 mm | Φ 12 x 12 mm | - |
| | Φ 14 x 14 mm | 1784/6 |
| H 1000 mm | Φ 12 x 12 mm | 1784/7/S |
| | Φ 14 x 14 mm | - |
| H 1500 mm | Φ 12 x 12 mm | - |
| | Φ 14 x 14 mm | 1784/9 |

i Arteferro products can be manufactured as well as customised.

I prodotti Arteferro sono realizzabili anche su misura.



170 mm

125 mm



Plain
Liscio



Hammered
Spigolato



Bark effect
Corteccia



| Height Altezza | Section Sezione | Art. | Art. | Art. | Art. | Art. |
|-------------------|--------------------|---------|---------|---------|----------|----------|
| H 1000 mm | Φ 12 x 12 mm | 1701/13 | 1702/13 | 1705/13 | GD273/9 | GD274/9 |
| | Φ 14 x 14 mm | 1701/14 | 1702/14 | 1705/14 | GD273/10 | GD274/11 |
| | Ø 12 mm | 1779/13 | 1779/11 | 1779/9 | - | - |
| | Ø 14 mm | 1779/14 | 1779/12 | 1779/10 | - | - |

| | | | | | | |
|-----------|--------------|--------|--------|--------|---|---|
| H 1000 mm | Φ 12 x 12 mm | 1780/5 | 1780/3 | 1780/1 | - | - |
| | Φ 14 x 14 mm | 1780/6 | 1780/4 | 1780/2 | - | - |

| | | | | | | |
|-----------|--------------|---------|---------|---------|---|---|
| H 1000 mm | Φ 12 x 12 mm | 1780/13 | 1780/11 | 1780/9 | - | - |
| | Φ 14 x 14 mm | 1780/14 | 1780/12 | 1780/10 | - | - |

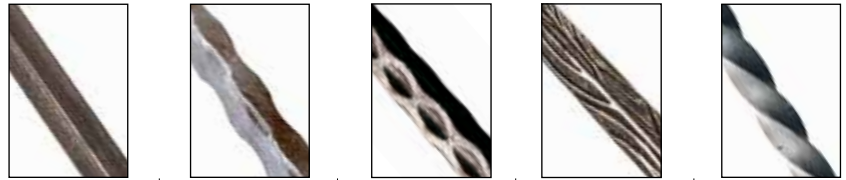
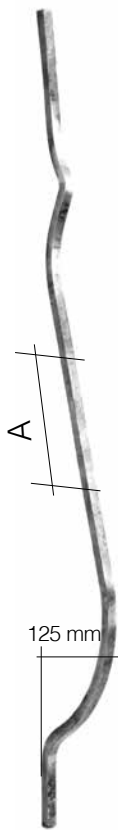

| Height Altezza | Section Sezione | Art. | Art. | Art. | Art. | Art. |
|-------------------|--------------------|--------------------------|--------|---------|---------|---------|
| H 900 mm | Φ 12 x 12 mm | 64/D/4 | - | - | - | 64/D/3 |
| | Φ 14 x 14 mm | 64/D/9 BEST PRICE | - | - | - | 64/D/8 |
| | Ø 12 mm | 64/D/5 | - | - | - | - |
| | Ø 14 mm | 64/D/6 | - | - | - | - |
| H 1000 mm | Φ 12 x 12 mm | 1779/7 | 1780/7 | 1137/11 | 1780/15 | 64/D/7 |
| | Φ 14 x 14 mm | 1779/8 | 1780/8 | 1137/12 | 1780/16 | 64/D/10 |
| | Ø 12 mm | 1779/15 | - | - | - | - |
| | Ø 14 mm | 1779/16 | - | - | - | - |
| H 1200 mm | Φ 12 x 12 mm | - | - | 1137/13 | - | - |
| | Φ 14 x 14 mm | - | - | 1137/14 | - | - |

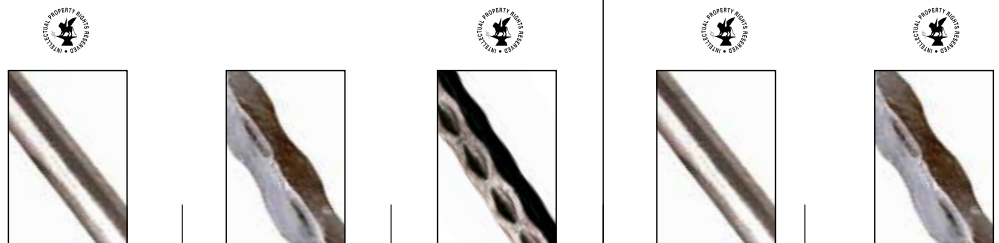

| Height Altezza | Section Sezione | Art. | Art. | Art. | Art. | Art. |
|-------------------|--------------------|-------|-----------|---------|--------|-----------|
| H 900 mm | Φ 12 x 12 mm | - | 64/H/9 | - | - | 578/17 |
| | Φ 14 x 14 mm | - | 64/H/10 | - | - | 578/19 |
| | Ø 12 mm | 572/1 | - | - | 578/13 | - |
| | Ø 14 mm | 572/3 | - | - | 578/15 | - |
| H 1000 mm | Φ 12 x 12 mm | - | 64/H/9/S | 1137/7 | - | 578/18/S1 |
| | Φ 14 x 14 mm | - | 64/H/10/S | 1137/8 | - | - |
| H 1200 mm | Φ 12 x 12 mm | - | 64/H/19 | 1137/9 | - | 578/18 |
| | Φ 14 x 14 mm | - | 64/H/20 | 1137/10 | - | 578/20 |
| | Ø 12 mm | 572/2 | - | - | 578/14 | - |
| | Ø 14 mm | 572/4 | - | - | 578/16 | - |

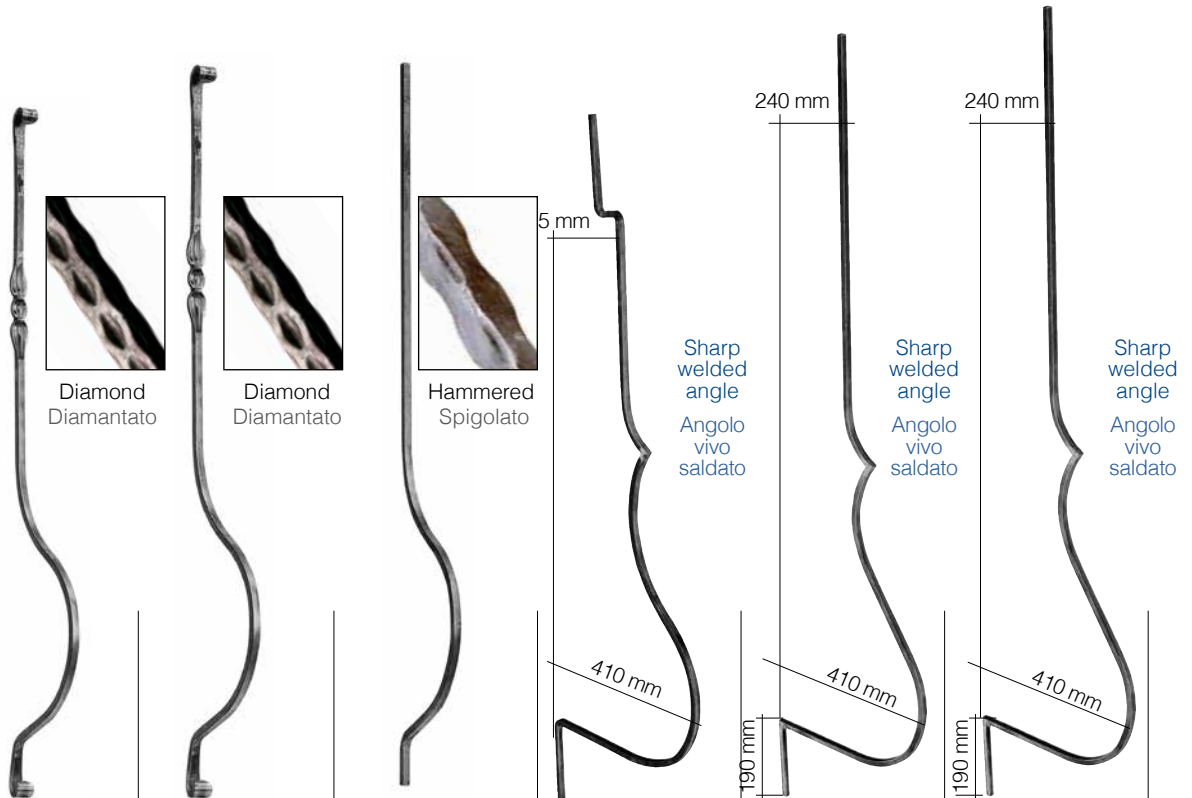

| | | | | | | |
|--------------------|-----------|-----------|-----------|-----------|-----------|-----------|
| | H 1200 mm | H 1500 mm | H 1500 mm | H 1200 mm | H 1600 mm | H 1800 mm |
| Section Sezione | Art. | Art. | Art. | Art. | Art. | Art. |
| Φ 14 x 14 mm | 1268/52 | 1268/53 | 1267/9 | 1271/5 | 1271/3 | 1271/4 |



i Arteferro products can be manufactured as well as customised.
I prodotti Arteferro sono realizzabili anche su misura.

Bowed on the belly
Bombati sulla pancia

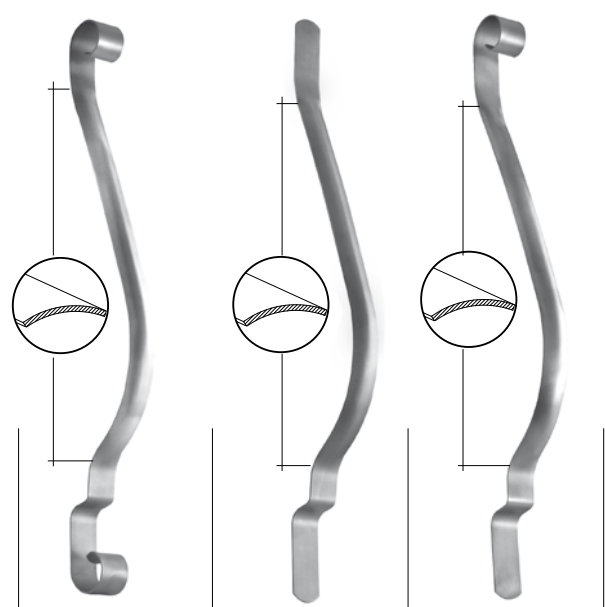

| | | | |
|--------------------|----------|----------|----------|
| | Art. | Art. | Art. |
| | H 870 mm | H 900 mm | H 900 mm |
| Section Sezione | Art. | Art. | Art. |
| ∅ 50 x 3 mm | 46/10 | 46/11 | 46/12 |

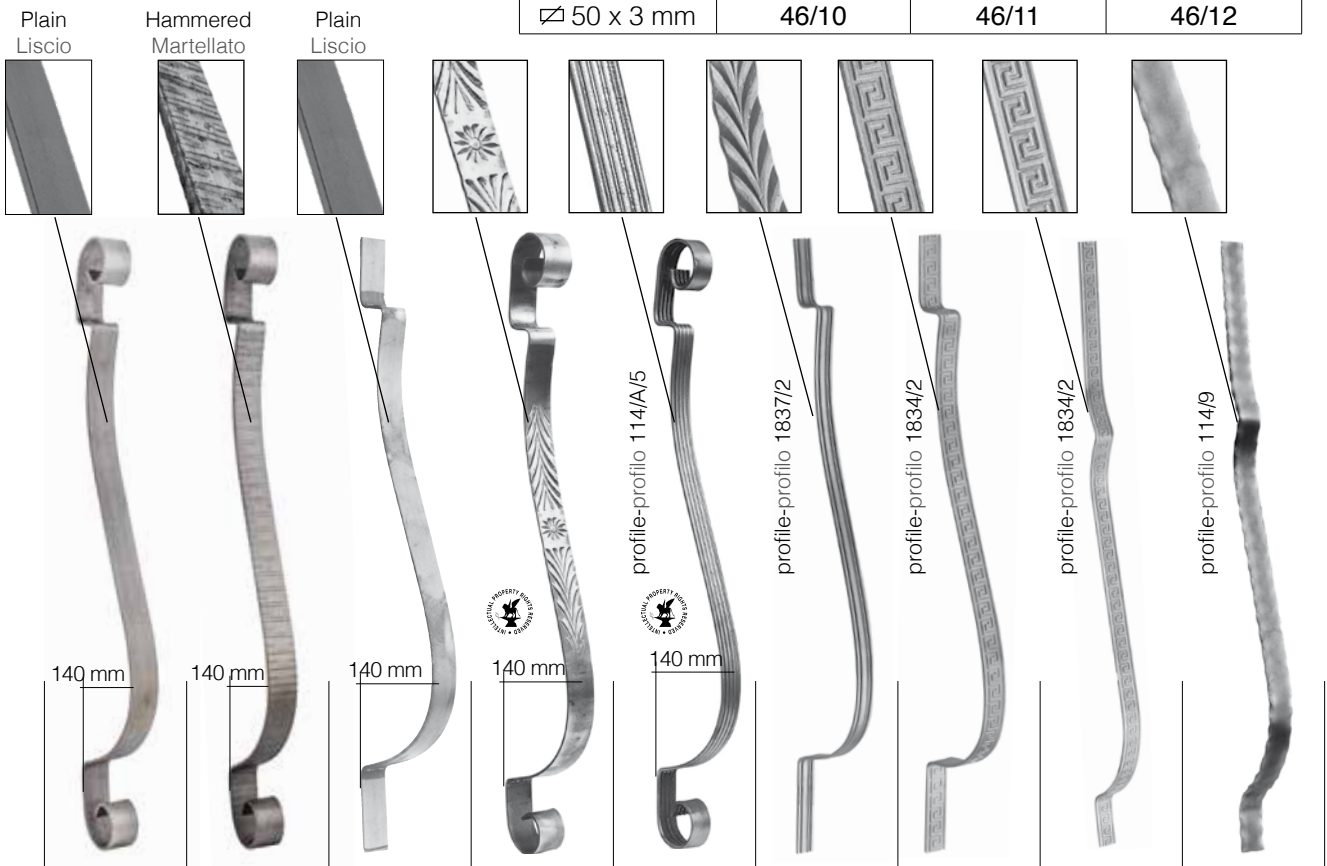

| | | | | | | | | | |
|--------------------|----------|----------|----------|----------|----------|----------|----------|-----------|-----------|
| | H 800 mm | H 800 mm | H 800 mm | H 800 mm | H 800 mm | H 800 mm | H 800 mm | H 1000 mm | H 1000 mm |
| Section Sezione | Art. | Art. | Art. | Art. | Art. | Art. | Art. | Art. | Art. |
| ∅ 25 x 4 mm | 46/3 | 46/4 | - | - | - | - | - | - | - |
| ∅ 27 x 5 mm | - | - | - | - | - | 1789/3 | - | - | - |
| ∅ 30 x 5 mm | - | - | - | - | 1276/1 | - | - | - | - |
| ∅ 30 x 8 mm | - | - | - | - | - | - | - | - | 1787/9 |
| ∅ 31 x 5 mm | - | - | - | - | - | - | 1789/4 | 1787/4 | - |
| ∅ 40 x 4 mm | 46/5 | 46/6 | 589/4 | 589/5 | - | - | - | - | - |



| | Art. | Art. | Art. | Art. | Art. | Art. |
|--------------------|----------|----------|-----------|-----------|-----------|-----------|
| Section Sezione | H 900 mm | H 910 mm | H 1000 mm | H 1000 mm | H 1000 mm | H 1000 mm |
| ∅ 30 x 4 mm | 1785/1 | - | - | - | - | - |
| ∅ 30 x 8 mm | - | - | 44/11 | 44/13 | - | - |
| ∅ 40 x 4 mm | - | 1785/5 | - | - | 45/19 | 45/20 |
| ∅ 40 x 8 mm | - | - | 44/12 | 44/14 | - | - |
| ∅ 50 x 4 mm | - | - | - | - | 45/21 | 45/22 |

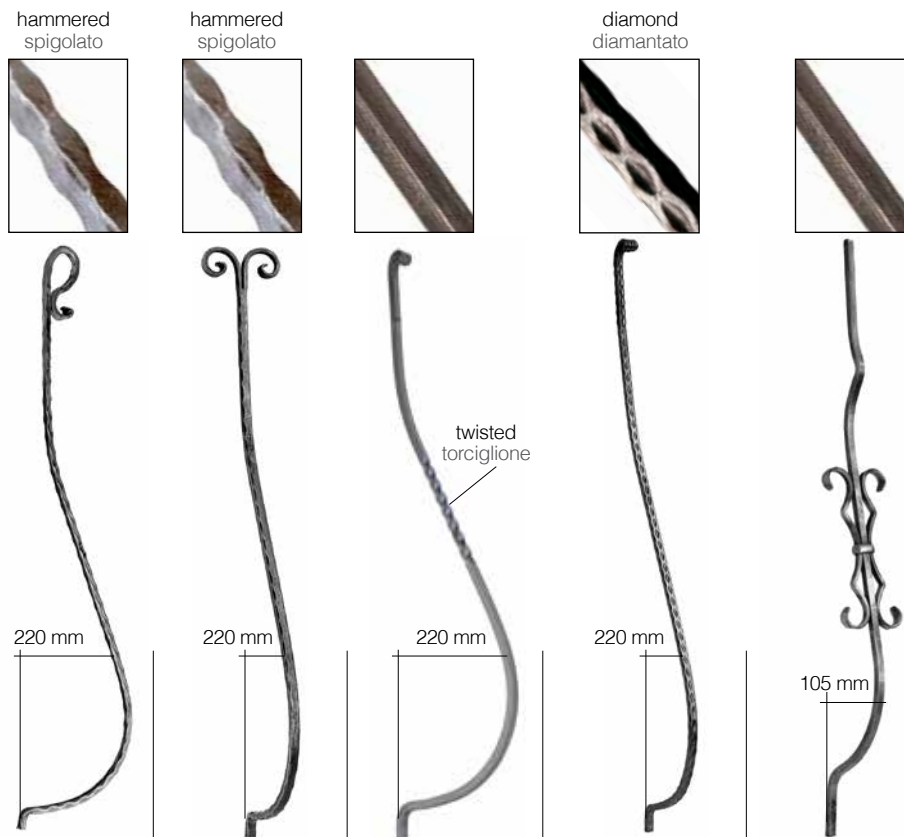

| | Art. | Art. | Art. | Art. | Art. |
|--------------------|----------|----------|----------|----------|-----------|
| Section Sezione | H 900 mm | H 900 mm | H 900 mm | H 900 mm | H 1000 mm |
| ∅ 12 x 12 mm | 591/3 | 591/1 | 47/4 | 1269/7 | 64/D/1 |
| ∅ 14 x 14 mm | 591/4 | 591/2 | 47/10 | 1269/11 | - |



Arteferro pickets are a convenient solution for building a fence. Made with different sections, round or square, they are available in an infinite number of processes and finishes, and can be embellished with other items, like baskets, studs, scrolls, leaves or knots. Just block them with horizontal supporting elements and you're done.

I paletti per recinzione Arteferro rappresentano una comoda soluzione per la composizione di una recinzione. Realizzati con diverse sezioni, tonde o quadrate, sono disponibili in un'infinità di lavorazioni e finiture e possono essere abbelliti con altri elementi quali pigne, borchie, ricci, foglie o nodi. Basterà bloccarli con degli elementi orizzontali a sostegno ed il gioco è fatto.

PALETTI PER RECINZIONE PICKETS FOR FENCING

7.

Pickets for fencing
Paletti per recinzione

7.A Stamped picketspag.162
Paletti conati

7.B Electrowelded pickets pag.171
Paletti elettrosaldati

CHOOSE YOUR FINISH - SCEGLI LA TUA FINITURA

In a way that matches the manufacturing possibilities, Arteferro products can be customized with the following finishes

Compatibilmente con le possibilità produttive, i prodotti Arteferro si possono personalizzare con le seguenti finiture



Plain finish
Finitura
Liscia



Bark effect finish
Finitura
Corteccia



Grooved finish
Finitura
Rigata



Hammered finish
Finitura
Spigolata



Four-leaf clover finish
Finitura
Quadrifoglio

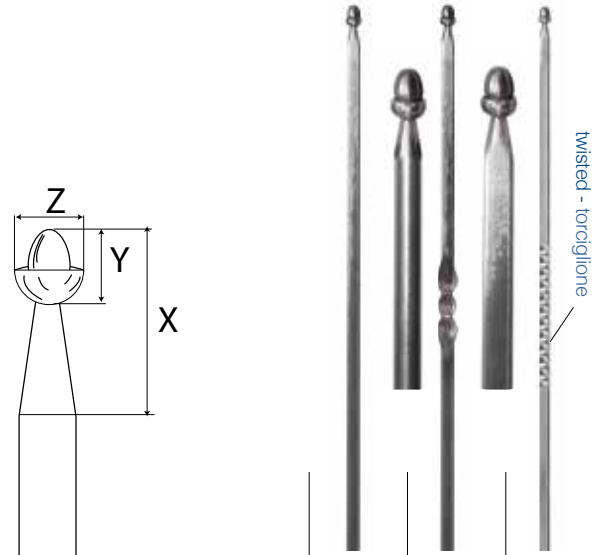
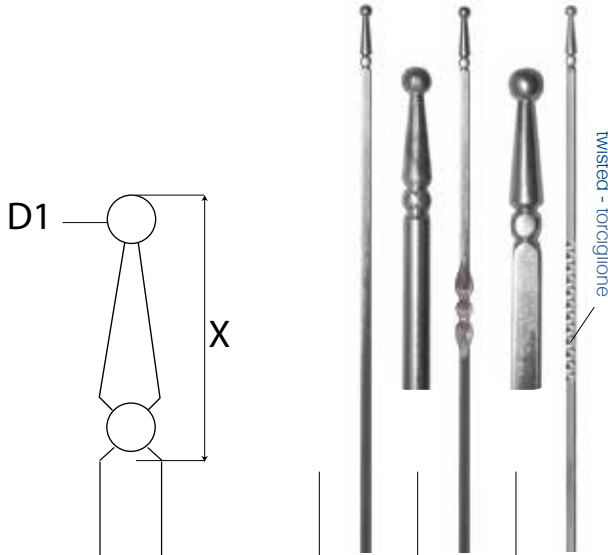

| Section - Sezione | Finish - Finitura | H | Art. | Art. | Art. |
|---|-------------------|---------|---------|---------|---------|
| \varnothing 10 x 10 mm X = 68 mm D1 = \varnothing 13 mm | | 150 mm | 1758/22 | - | - |
| | | 1000 mm | 1758/23 | 1758/26 | 1758/29 |
| | | 1200 mm | 1758/24 | 1758/27 | 1758/30 |
| | | 1500 mm | 1758/25 | 1758/28 | 1758/31 |
| \varnothing 12 x 12 mm X = 80 mm y = \varnothing 16 mm | | 150 mm | 1758/32 | - | - |
| | | 1000 mm | 1758/33 | 1758/36 | 1758/39 |
| | | 1200 mm | 1758/34 | 1758/37 | 1758/40 |
| | | 1500 mm | 1758/35 | 1758/38 | 1758/41 |
| \varnothing 12 mm X = 68 mm D1 = \varnothing 13 mm | | 150 mm | 1758/1 | - | - |
| | | 1000 mm | 1758/2 | 1758/5 | - |
| | | 1200 mm | 1758/3 | 1758/6 | - |
| | | 1500 mm | 1758/4 | 1758/7 | - |
| \varnothing 14 x 14 mm X = 91 mm D1 = \varnothing 18 mm | | 150 mm | 1758/42 | - | - |
| | | 1000 mm | 1758/43 | 1758/46 | 1758/49 |
| | | 1200 mm | 1758/44 | 1758/47 | 1758/50 |
| | | 1500 mm | 1758/45 | 1758/48 | 1758/51 |
| \varnothing 14 mm X = 80 mm D1 = \varnothing 16 mm | | 150 mm | 1758/8 | - | - |
| | | 1000 mm | 1758/9 | 1758/12 | - |
| | | 1200 mm | 1758/10 | 1758/13 | - |
| | | 1500 mm | 1758/11 | 1758/14 | - |
| \varnothing 16 mm X = 91 mm D1 = \varnothing 18 mm | | 150 mm | 1758/15 | - | - |
| | | 1000 mm | 1758/16 | 1758/19 | - |
| | | 1200 mm | 1758/17 | 1758/20 | - |
| | | 1500 mm | 1758/18 | 1758/21 | - |
| ∇ 14 x 8 mm X = 68 mm D1 = \varnothing 13 mm | | 150 mm | 1758/52 | - | - |
| | | 1000 mm | 1758/53 | 1758/56 | 1758/59 |
| | | 1200 mm | 1758/54 | 1758/57 | 1758/60 |
| | | 1500 mm | 1758/55 | 1758/58 | 1758/61 |

| Section - Sezione | Finish - Finitura | H | Art. | Art. | Art. |
|---|-------------------|---------|---------|---------|---------|
| \varnothing 10 x 10 mm X = 66 mm Y = \varnothing 21 mm Z = \varnothing 14 mm | | 150 mm | 1757/29 | - | - |
| | | 1000 mm | 1757/30 | 1757/33 | 1757/36 |
| | | 1200 mm | 1757/31 | 1757/34 | 1757/37 |
| | | 1500 mm | 1757/32 | 1757/35 | 1757/38 |
| \varnothing 12 x 12 mm X = 55 mm Y = \varnothing 23 mm Z = \varnothing 16 mm | | 150 mm | 1757/39 | - | - |
| | | 1000 mm | 1757/40 | 1757/43 | 1757/46 |
| | | 1200 mm | 1757/41 | 1757/44 | 1757/47 |
| | | 1500 mm | 1757/42 | 1757/45 | 1757/48 |
| \varnothing 12 mm X = 66 mm Y = \varnothing 21 mm Z = \varnothing 15 mm | | 150 mm | 1757/1 | - | - |
| | | 1000 mm | 1757/2 | 1757/5 | - |
| | | 1200 mm | 1757/3 | 1757/6 | - |
| | | 1500 mm | 1757/4 | 1757/7 | - |
| \varnothing 14 x 14 mm X = 55 mm Y = \varnothing 24 mm Z = \varnothing 18 mm | | 150 mm | 1757/49 | - | - |
| | | 1000 mm | 1757/50 | 1757/53 | 1757/56 |
| | | 1200 mm | 1757/51 | 1757/54 | 1757/57 |
| | | 1500 mm | 1757/52 | 1757/55 | 1757/58 |
| \varnothing 14 mm X = 55 mm Y = \varnothing 23 mm Z = \varnothing 16 mm | | 150 mm | 1757/8 | - | - |
| | | 1000 mm | 1757/9 | 1757/12 | - |
| | | 1200 mm | 1757/10 | 1757/13 | - |
| | | 1500 mm | 1757/11 | 1757/14 | - |
| \varnothing 16 x 16 mm X = 60 mm Y = \varnothing 29 mm Z = \varnothing 20 mm | | 150 mm | 1757/59 | - | - |
| | | 1000 mm | 1757/60 | 1757/63 | 1757/66 |
| | | 1200 mm | 1757/61 | 1757/64 | 1757/67 |
| | | 1500 mm | 1757/62 | 1757/65 | 1757/68 |
| \varnothing 16 mm X = 55 mm Y = \varnothing 24 mm Z = \varnothing 18 mm | | 150 mm | 1757/15 | - | - |
| | | 1000 mm | 1757/16 | 1757/19 | - |
| | | 1200 mm | 1757/17 | 1757/20 | - |
| | | 1500 mm | 1757/18 | 1757/21 | - |
| \varnothing 18 mm X = 60 mm Y = \varnothing 29 mm Z = \varnothing 20 mm | | 150 mm | 1757/22 | - | - |
| | | 1000 mm | 1757/23 | 1757/26 | - |
| | | 1200 mm | 1757/24 | 1757/27 | - |
| | | 1500 mm | 1757/25 | 1757/28 | - |
| ∇ 14 x 8 mm X = 66 mm Y = \varnothing 21 mm Z = \varnothing 15 mm | | 150 mm | 1757/69 | - | - |
| | | 1000 mm | 1757/70 | 1757/73 | 1757/76 |
| | | 1200 mm | 1757/71 | 1757/74 | 1757/77 |
| | | 1500 mm | 1757/72 | 1757/75 | 1757/78 |

i Arteferro products can be manufactured as well as customised.
I prodotti Arteferro sono realizzabili anche su misura.

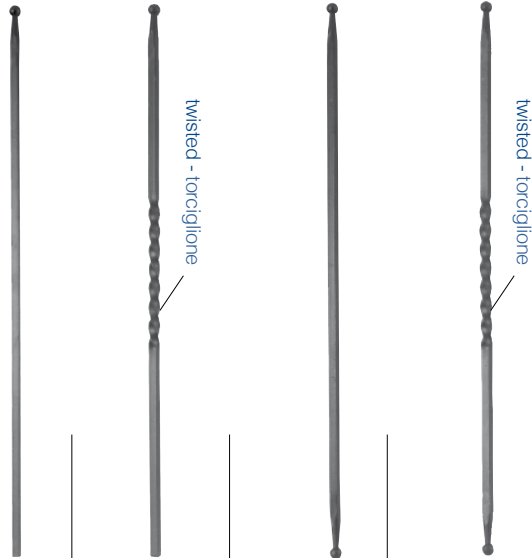
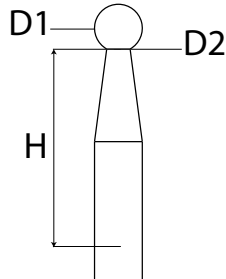

| Section - Sezione | Finish - Finitura | H | Art. | Art. | Art. | Art. |
|---|---|---------|----------|---------------|---------------|---------------|
| Φ 12 x 12 mm H = 31 mm D1 = 16 mm D2 = 7,6 mm | Plain - Liscio  | 200 mm | 118/C/63 | - | - | - |
| | | 700 mm | 118/C/9 | 118/C/5 | 118/C/21 | 118/C/14 |
| | | 900 mm | 118/C/10 | 118/C/6 | 118/C/22 | 118/C/15 |
| | | 1000 mm | 118/C/33 | 118/C/28 | 118/C/23 | 118/C/16 |
| | | 1200 mm | 118/C/53 | 118/C/28/1200 | 118/C/23/1200 | 118/C/16/1200 |
| | | 1500 mm | 118/C/54 | - | - | - |
| Φ 12 mm H = 28 mm D1 = 12 mm D2 = 6,1 mm | Plain - Liscio  | 200 mm | 118/C/66 | - | - | - |
| | | 700 mm | 118/C/45 | - | 118/C/37 | - |
| | | 900 mm | 118/C/46 | - | 118/C/38 | - |
| | | 1000 mm | 118/C/47 | - | 118/C/39 | - |
| | | 1200 mm | 118/C/58 | - | 118/C/39/1200 | - |
| | | 1500 mm | 118/C/59 | - | - | - |
| Φ 14 x 14 mm H = 37 mm D1 = 18 mm D2 = 9,8 mm | Plain - Liscio  | 200 mm | 118/C/64 | - | - | - |
| | | 700 mm | 118/C/11 | 118/C/7 | 118/C/3 | 118/C/1 |
| | | 900 mm | 118/C/12 | 118/C/8 | 118/C/4 | 118/C/2 |
| | | 1000 mm | 118/C/32 | 118/C/27 | 118/C/20 | 118/C/13 |
| | | 1200 mm | 118/C/55 | 118/C/27/1200 | 118/C/20/1200 | 118/C/13/1200 |
| | | 1500 mm | 118/C/56 | - | - | - |
| Φ 14 mm H = 28 mm D1 = 16 mm D2 = 6,9 mm | Plain - Liscio  | 200 mm | 118/C/67 | - | - | - |
| | | 700 mm | 118/C/48 | - | 118/C/40 | - |
| | | 900 mm | 118/C/49 | - | 118/C/41 | - |
| | | 1000 mm | 118/C/50 | - | 118/C/42 | - |
| | | 1200 mm | 118/C/60 | - | 118/C/42/1200 | - |
| | | 1500 mm | 118/C/61 | - | - | - |
| Φ 16 x 16 mm H = 45 mm D1 = 20 mm D2 = 6,1 mm | Plain - Liscio  | 200 mm | 118/C/65 | - | - | - |
| | | 700 mm | 118/C/72 | 118/C/7/Q16 | 118/C/106 | 118/C/1/Q16 |
| | | 900 mm | 118/C/34 | 118/C/29 | 118/C/24 | 118/C/17 |
| | | 1000 mm | 118/C/35 | 118/C/30 | 118/C/25 | 118/C/18 |
| | | 1200 mm | 118/C/36 | 118/C/31 | 118/C/26 | 118/C/19 |
| | | 1500 mm | 118/C/57 | - | - | - |
| Φ 16 mm H = 25,6 mm D1 = 18 mm D2 = 9,7 mm | Plain - Liscio  | 200 mm | 118/C/68 | - | - | - |
| | | 700 mm | 118/C/96 | - | 118/C/40/T16 | - |
| | | 900 mm | 118/C/97 | - | 118/C/43 | - |
| | | 1000 mm | 118/C/51 | - | 118/C/44 | - |
| | | 1200 mm | 118/C/52 | - | 118/C/44/1200 | - |
| | | 1500 mm | 118/C/62 | - | - | - |

| Diam. | H | Plain | Hammered | Sec.- Sez. | H | Art. |
|-------------------|---------|--------|-----------|--------------|---------|--------|
| | | Liscio | Spigolato | | | |
| Φ 25 x 25 mm | 200 mm | 1382/2 | 1382/6 | Φ 25 mm | 200 mm | 1382/4 |
| | 1000 mm | 42/B/5 | - | | 1000 mm | - |
| | 1200 mm | 42/B/6 | - | | 1200 mm | - |
| Φ 30 x 30 mm | 200 mm | 1382/3 | 1382/7 | Φ 30 mm | 200 mm | 1382/5 |
| | 1000 mm | 42/B/7 | - | | 1000 mm | - |
| | 1200 mm | 42/B/8 | - | | 1200 mm | - |
| Φ 40 x 40 mm | 200 mm | 1382/1 | 1382/8 | Φ 40 mm | 200 mm | - |
| | 1000 mm | - | - | | 1000 mm | - |
| | 1200 mm | - | - | | 1200 mm | - |

Newel Post - Caposaldo



Plain
LiscioHammered
SpigolatoPlain
Liscio

pyramid spear point - punta piramidale



| H | Section Sezione | Art. | Art. | Art. |
|---------|--------------------|----------|----------|----------|
| 300 mm | 12 mm | 132/C/12 | - | 132/C/18 |
| | 14 mm | 132/C/13 | - | 132/C/19 |
| | 16 mm | 132/C/14 | - | 132/C/20 |
| | 18 mm | - | - | - |
| | 20 mm | 132/C/15 | - | 132/C/21 |
| | 22 mm | - | - | - |
| | 25 mm | 132/C/16 | - | 132/C/22 |
| | 30 mm | 132/C/17 | - | 132/C/23 |
| 900 mm | 12 mm | 132/B/37 | 132/B/46 | 132/C/1 |
| | 14 mm | 132/B/40 | 132/B/49 | 132/C/4 |
| | 16 mm | 132/B/43 | 132/B/52 | 132/C/7 |
| | 18 mm | - | - | - |
| | 20 mm | - | - | - |
| | 22 mm | - | - | - |
| | 25 mm | - | - | - |
| | 30 mm | - | - | - |
| 1000 mm | 12 mm | - | - | 132/C/32 |
| | 14 mm | 132/D/1 | - | 132/D/11 |
| | 16 mm | 132/D/3 | - | 132/D/13 |
| | 18 mm | 132/D/5 | - | 132/D/15 |
| | 20 mm | 132/D/8 | - | 132/D/18 |
| | 22 mm | - | - | - |
| | 25 mm | - | - | - |
| | 30 mm | - | - | - |
| 1200 mm | 12 mm | 132/B/38 | 132/B/47 | 132/C/2 |
| | 14 mm | 132/B/41 | 132/B/50 | 132/C/5 |
| | 16 mm | 132/B/44 | 132/B/53 | 132/C/8 |
| | 18 mm | - | - | - |
| | 20 mm | - | - | - |
| | 22 mm | - | - | - |
| | 25 mm | - | - | - |
| | 30 mm | - | - | - |
| 1500 mm | 12 mm | 132/B/39 | 132/B/48 | 132/C/3 |
| | 14 mm | 132/B/42 | 132/B/51 | 132/C/6 |
| | 16 mm | 132/B/45 | 132/B/54 | 132/C/9 |
| | 18 mm | 132/D/6 | - | 132/D/16 |
| | 20 mm | 132/D/9 | - | 132/D/19 |
| | 22 mm | - | - | 132/C/28 |
| | 25 mm | - | - | 132/C/10 |
| | 30 mm | - | - | - |
| 2000 mm | 12 mm | - | - | - |
| | 14 mm | 132/D/2 | - | 132/D/12 |
| | 16 mm | 132/D/4 | - | 132/D/14 |
| | 18 mm | 132/D/7 | 132/B/83 | 132/D/17 |
| | 20 mm | 132/D/10 | 132/B/84 | 132/D/20 |
| | 22 mm | - | - | 132/C/29 |
| | 25 mm | - | - | - |
| | 30 mm | - | - | - |

conic spear point - punta conica



pyramid spear point - punta piramidale



Arteferro products
can be manufactured
as well as customised.

I prodotti Arteferro
sono realizzabili
anche su misura.







| H | Section Sezione | Art. | Art. |
|---------|--------------------|----------|----------|
| 900 mm | 12 mm | 132/B/55 | 132/B/64 |
| | 14 mm | 132/B/58 | 132/B/67 |
| | 16 mm | 132/B/61 | 132/B/70 |
| 1200 mm | 12 mm | 132/B/56 | 132/B/65 |
| | 14 mm | 132/B/59 | 132/B/68 |
| | 16 mm | 132/B/62 | 132/B/71 |
| 1500 mm | 12 mm | 132/B/57 | 132/B/66 |
| | 14 mm | 132/B/60 | 132/B/69 |
| | 16 mm | 132/B/63 | 132/B/72 |
| 2000 mm | 18 mm | 132/B/85 | 132/B/87 |
| | 20 mm | 132/B/86 | 132/B/88 |



Arteferro products can be manufactured as well as customised.

I prodotti Arteferro sono realizzabili anche su misura.



| Section - Sezione | Finish - Finitura | H | Art. | Art. | Art. |
|-------------------|--|---------|------------|--------|--------|
| Ø 12 x 12 mm | Plain Liscio  | 100 mm | 129/6 | - | - |
| | | 200 mm | - | 129/2 | 129/4 |
| | | 800 mm | 130/51 | 130/21 | 130/11 |
| | | 900 mm | 130/52 | 130/22 | 130/12 |
| | | 1000 mm | 130/53 | 130/23 | 130/13 |
| | | 1200 mm | 130/54 | 130/24 | 130/14 |
| | | 1500 mm | 130/55 | 130/25 | 130/15 |
| Ø 12 mm | Plain Liscio  | 100 mm | - | - | - |
| | | 200 mm | 1080/9/200 | - | - |
| | | 800 mm | 1080/9/S3 | - | - |
| | | 900 mm | 1080/9/S8 | - | - |
| | | 1000 mm | 1080/9 | - | - |
| | | 1200 mm | 1080/9/S1 | - | - |
| | | 1500 mm | 1080/9/S9 | - | - |
| Ø 14 x 14 mm | Plain Liscio  | 100 mm | 129/5 | - | - |
| | | 200 mm | - | 129/1 | 129/3 |
| | | 800 mm | 130/56 | 130/26 | 130/16 |
| | | 900 mm | 130/57 | 130/27 | 130/17 |
| | | 1000 mm | 130/58 | 130/8 | 130/18 |
| | | 1200 mm | 130/59 | 130/29 | 130/19 |
| | | 1500 mm | 130/60 | 130/30 | 130/20 |
| Ø 14 mm | Plain Liscio  | 100 mm | - | - | - |
| | | 200 mm | 1080/9/S14 | - | - |
| | | 800 mm | 1080/9/S10 | - | - |
| | | 900 mm | 1080/9/S11 | - | - |
| | | 1000 mm | 1080/9/S12 | - | - |
| | | 1200 mm | 1080/9/S13 | - | - |
| | | 1500 mm | 1080/9/S4 | - | - |



Top for post
Punta per caposaldo

| Sec.-Sez. | Art. | H | H1 | L1 |
|-----------|--------|--------|--------|-------|
| ∅ 20 mm | 129/17 | 250 mm | 147 mm | 60 mm |
| ∅ 30 mm | 129/18 | 250 mm | 165 mm | 72 mm |

| Sec.-Sez. | A | | B | | |
|-----------|--------|-------|--------|-------|-------|
| | H1 | L1 | H1 | L1 | D=∅ |
| ∅ 12 mm | 115 mm | 43 mm | 132 mm | 43 mm | 16 mm |
| ∅ 12 mm | 115 mm | 40 mm | 125 mm | 40 mm | 14 mm |
| ∅ 14 mm | 128 mm | 50 mm | 143 mm | 50 mm | 16 mm |
| ∅ 14 mm | 125 mm | 45 mm | 140 mm | 45 mm | 16 mm |

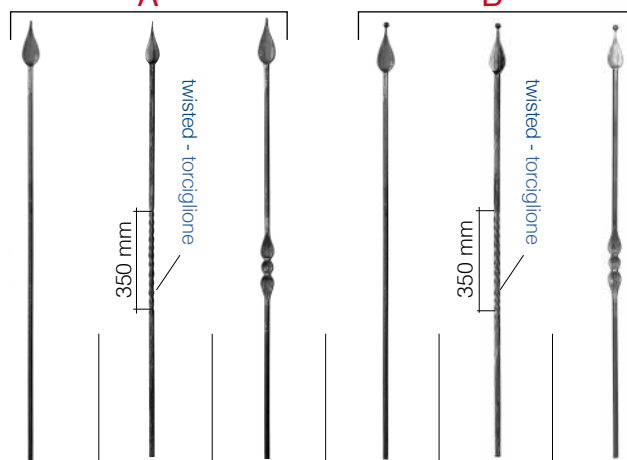
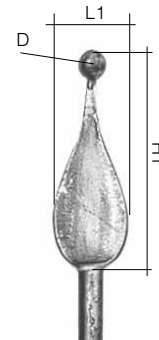

| Section - Sezione | Finish - Finitura | H | Art. | Art. | Art. | Art. | Art. | Art. |
|-------------------|---------------------------------|---------------------------------|---------|---------|---------|---------|---------|---------|
| ∅ 12 x 12 mm | Plain - Liscio | 200 mm | 129/10 | - | - | 722/5 | - | - |
| | | 800 mm | 130/31 | - | - | - | - | - |
| | | 900 mm | 130/32 | - | - | - | - | - |
| | | 1000 mm | 130/33 | - | 1263/27 | 1263/13 | - | 1263/19 |
| | | 1200 mm | 130/34 | - | 1263/29 | 1263/15 | - | 1263/21 |
| | Bark effect - Corteccia | 1000 mm | 1261/31 | 1261/25 | 1261/19 | 1260/31 | 1260/25 | 1260/19 |
| | | 1200 mm | 1261/33 | 1261/27 | 1261/21 | 1260/33 | 1260/27 | 1260/21 |
| | | 1500 mm | 1261/35 | 1261/29 | 1261/23 | 1260/35 | 1260/29 | 1260/23 |
| | | Four-leaf clover - Quadrifoglio | 1000 mm | - | - | - | - | - |
| ∅ 12 mm | Plain - Liscio | 200 mm | 1385/7 | - | - | 1385/13 | - | - |
| | | 1000 mm | 1262/37 | - | 1262/43 | 1262/13 | - | 1262/19 |
| | | 1200 mm | 1262/39 | - | 1262/45 | 1262/15 | - | 1262/21 |
| | | 1500 mm | 1262/41 | - | 1262/47 | 1262/17 | - | 1262/23 |
| ∅ 14 x 14 mm | Plain - Liscio | 200 mm | 129/9 | - | - | 722/6 | - | - |
| | | 800 mm | 130/36 | - | - | - | - | - |
| | | 900 mm | 130/37 | - | - | - | - | - |
| | | 1000 mm | 130/38 | - | 1263/28 | 1263/14 | - | 1263/20 |
| | | 1200 mm | 130/39 | - | 1263/30 | 1263/16 | - | 1263/22 |
| | Four-leaf clover - Quadrifoglio | 1000 mm | 1261/32 | 1261/26 | 1261/20 | 1260/32 | 1260/26 | 1260/20 |
| | | 1200 mm | 1261/34 | 1261/28 | 1261/22 | 1260/34 | 1260/28 | 1260/22 |
| ∅ 14 mm | Plain - Liscio | 200 mm | 1385/8 | - | - | 1385/14 | - | - |
| | | 1000 mm | 1262/38 | - | 1262/44 | 1262/14 | - | 1262/20 |
| | | 1200 mm | 1262/40 | - | 1262/46 | 1262/16 | - | 1262/22 |
| | | 1500 mm | 1262/42 | - | 1262/48 | 1262/18 | - | 1262/24 |

| Sec.-Sez. | C | | D | | |
|-----------|--------|-------|--------|---------------------------|-------|
| | H1 | L1 | H1 | L1 | D=Ø |
| ∅ 12 mm | 145 mm | 43 mm | 132 mm | 43 mm | 16 mm |
| ∅ 12 mm | 145 mm | 40 mm | 150 mm | 40 mm | 14 mm |
| ∅ 14 mm | 156 mm | 50 mm | 143 mm | 50 mm | 16 mm |
| ∅ 14 mm | 145 mm | 45 mm | 163 mm | 45 mm </td <td>16 mm</td> | 16 mm |

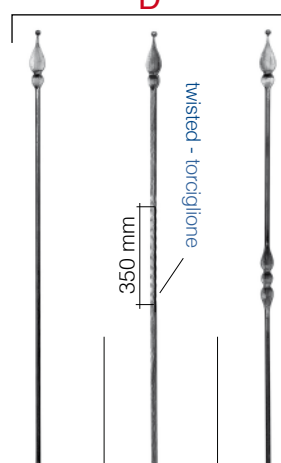
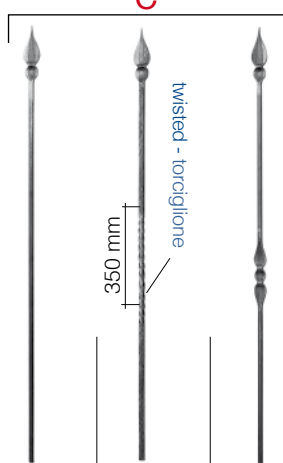
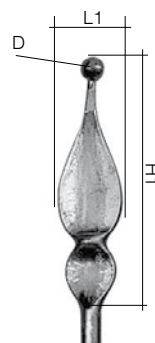
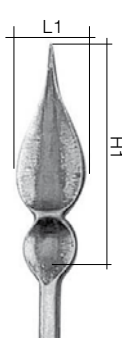

i Arterferro products can be manufactured as well as customised.
I prodotti Arterferro sono realizzabili anche su misura.

| Section - Sezione | Finish - Finitura | H | Art. | Art. | Art. | Art. | Art. | Art. |
|---------------------------------|---------------------------------|---------|---------|---------|---------|---------|---------|---------|
| ∅ 12 x 12 mm | Plain - Liscio | 200 mm | 129/8 | - | - | 722/3 | - | - |
| | | 800 mm | 130/1 | - | 134/17 | - | - | - |
| | | 900 mm | 130/2 | - | - | - | - | - |
| | | 1000 mm | 130/3 | - | 134/18 | 1263/1 | - | 1263/7 |
| | | 1200 mm | 130/4 | - | 134/19 | 1263/3 | - | 1263/9 |
| | Bark effect - Corteccia | 1500 mm | 130/5 | - | 1263/25 | 1263/5 | - | 1263/11 |
| | | 1000 mm | 1261/49 | 1261/43 | 1261/37 | 1260/49 | 1260/43 | 1260/37 |
| | | 1200 mm | 1261/51 | 1261/45 | 1261/3 | 1260/51 | 1260/45 | 1260/39 |
| | | 1500 mm | 1261/53 | 1261/47 | 1261/41 | 1260/53 | 1260/47 | 1260/41 |
| Four-leaf clover - Quadrifoglio | 1000 mm | 1261/67 | 1261/61 | 1261/55 | 1260/67 | 1260/61 | 1260/55 | |
| | 1200 mm | 1261/69 | 1261/63 | 1261/57 | 1260/69 | 1260/63 | 1260/57 | |
| | 1500 mm | 1261/71 | 1261/65 | 1261/59 | 1260/71 | 1260/65 | 1260/59 | |
| ∅ 12 mm | Plain - Liscio | 200 mm | 1385/4 | - | - | 1385/10 | - | - |
| | | 1000 mm | 1262/25 | - | 1262/31 | 1262/1 | - | 1262/7 |
| | | 1200 mm | 1262/27 | - | 1262/33 | 1262/3 | - | 1262/9 |
| | | 1500 mm | 1262/29 | - | 1262/35 | 1262/5 | - | 1262/11 |
| ∅ 14 x 14 mm | Plain - Liscio | 200 mm | 129/7 | - | - | 722/4 | - | - |
| | | 800 mm | 130/6 | - | 134/20 | - | - | - |
| | | 900 mm | 130/7 | - | - | - | - | - |
| | | 1000 mm | 130/8 | - | 134/21 | 1263/2 | - | 1263/8 |
| | | 1200 mm | 130/9 | - | 134/22 | 1263/4 | - | 1263/10 |
| | Four-leaf clover - Quadrifoglio | 1500 mm | 130/10 | - | 1263/26 | 1263/6 | - | 1263/12 |
| | | 1000 mm | 1261/50 | 1261/44 | 1261/38 | 1260/50 | 1260/44 | 1260/38 |
| | | 1200 mm | 1261/52 | 1261/46 | 1261/40 | 1260/52 | 1260/46 | 1260/40 |
| | | 1500 mm | 1261/54 | 1261/48 | 1261/42 | 1260/54 | 1260/48 | 1260/42 |
| ∅ 14 mm | Plain - Liscio | 200 mm | 1385/5 | - | - | 1385/11 | - | - |
| | | 1000 mm | 1262/26 | - | 1262/32 | 1262/2 | - | 1262/8 |
| | | 1200 mm | 1262/28 | - | 1262/34 | 1262/4 | - | 1262/10 |
| | | 1500 mm | 1262/30 | - | 1262/36 | 1262/6 | - | 1262/12 |

A

B

| Sec.-Sez. | H1 | H2 | L1 | L2 |
|-----------|--------|--------|-------|--------|
| ∅ 12 mm | 165 mm | 105 mm | 46 mm | 98 mm |
| ∅ 14 mm | 185 mm | 125 mm | 52 mm | 104 mm |

| H1 | H2 | L1 | L2 | D=∅ |
|--------|--------|-------|--------|-------|
| 180 mm | 120 mm | 46 mm | 98 mm | 16 mm |
| 200 mm | 145 mm | 52 mm | 104 mm | 16 mm |



Arteferro products can be manufactured as well as customised.

I prodotti Arteferro sono realizzabili anche su misura.

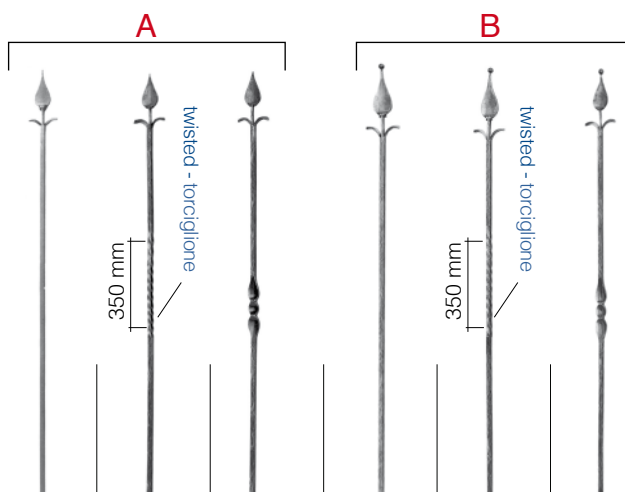
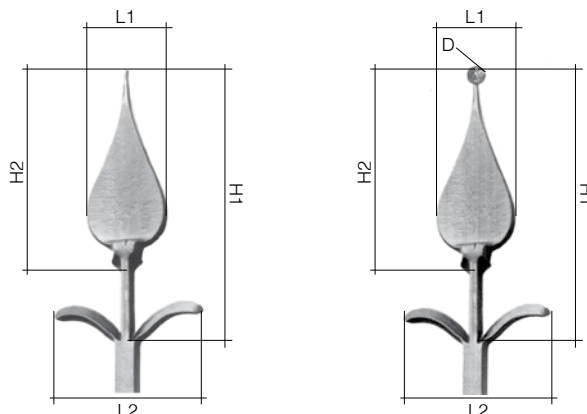

| Section - Sezione | Finish - Finitura | H | Art. | Art. | Art. | Art. | Art. | Art. |
|-------------------|--|---------|---------|---------|--------|---------|---------|--------|
| ∅ 12 x 12 mm |  Plain - Liscio | 200 mm | 129/12 | - | - | 722/1 | - | - |
| | | 230 mm | - | - | - | - | - | - |
| | | 800 mm | 130/41 | - | - | - | - | - |
| | | 900 mm | 130/42 | - | - | - | - | - |
| | | 1000 mm | 130/43 | - | - | - | - | - |
| | | 1200 mm | 130/44 | - | - | - | - | - |
| | | 1500 mm | 130/45 | - | - | - | - | - |
| ∅ 12 x 12 mm |  Bark effect - Cortecchia | 1000 mm | 1261/13 | 1261/7 | 1261/1 | 1260/13 | 1260/7 | 1260/1 |
| | | 1200 mm | 1261/15 | 1261/9 | 1261/3 | 1260/15 | 1260/9 | 1260/3 |
| | | 1500 mm | 1261/17 | 1261/11 | 1261/5 | 1260/17 | 1260/11 | 1260/5 |
| | | 200 mm | - | - | - | - | - | - |
| | | 230 mm | 129/11 | - | - | 722/2 | - | - |
| | | 800 mm | 130/46 | - | - | - | - | - |
| ∅ 14 x 14 mm |  Plain - Liscio | 900 mm | 130/47 | - | - | - | - | - |
| | | 1000 mm | 130/48 | - | - | - | - | - |
| | | 1200 mm | 130/49 | - | - | - | - | - |
| | | 1500 mm | 130/50 | - | - | - | - | - |
| | | 1000 mm | 1261/14 | 1261/8 | 1261/2 | 1260/14 | 1260/8 | 1260/2 |
| | | 1200 mm | 1261/16 | 1261/10 | 1261/4 | 1260/16 | 1260/10 | 1260/4 |
| | | 1500 mm | 1261/18 | 1261/12 | 1261/6 | 1260/18 | 1260/12 | 1260/6 |

i Arterferro products can be manufactured as well as customised.
I prodotti Arterferro sono realizzabili anche su misura.

A

| Sec.-Sez. | H1 | L1 |
|-----------|-------|-------|
| ∅ 12 mm | 75 mm | 35 mm |
| ∅ 12 mm | 77 mm | 33 mm |
| ∅ 14 mm | 87 mm | 41 mm |
| ∅ 14 mm | 86 mm | 38 mm |
| ∅ 16 mm | 95 mm | 46 mm |
| ∅ 16 mm | 92 mm | 43 mm |

B

| H1 | L1 | D1=∅ | D2=∅ |
|--------|-------|-------|------|
| 85 mm | 35 mm | 14 mm | 6 mm |
| 80 mm | 35 mm | 14 mm | 6 mm |
| 85 mm | 39 mm | 18 mm | 7 mm |
| 85 mm | 37 mm | 16 mm | 7 mm |
| 105 mm | 46 mm | 21 mm | 7 mm |
| 100 mm | 42 mm | 18 mm | 7 mm |

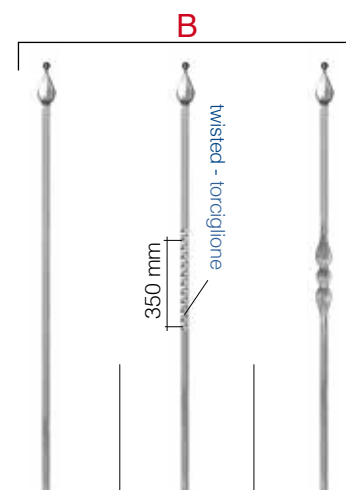
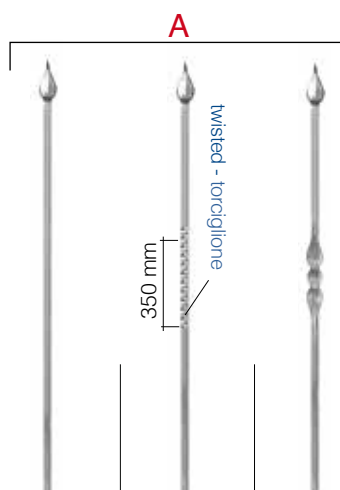
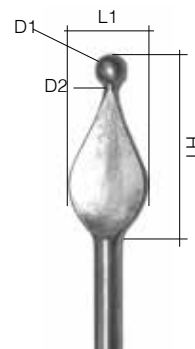
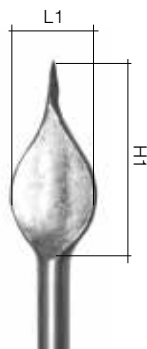

| Section - Sezione | Finish - Finitura | H | Art. | Art. | Art. | Art. | Art. | Art. |
|-------------------|-------------------|---------|---------|----------|---------|---------|---------|---------|
| ∅ 12 x 12 mm | | 150 mm | 1764/73 | - | - | 1764/43 | - | - |
| | | 1000 mm | 1764/76 | 1764/94 | 1764/85 | 1764/46 | 1764/64 | 1764/55 |
| | | 1200 mm | 1764/79 | 1764/97 | 1764/88 | 1764/49 | 1764/67 | 1764/58 |
| | | 1500 mm | 1764/82 | 1764/100 | 1764/91 | 1764/52 | 1764/70 | 1764/61 |
| ∅ 12 mm | | 150 mm | 1764/22 | - | 1764/34 | 1764/1 | - | - |
| | | 1000 mm | 1764/25 | - | 1764/37 | 1764/4 | - | 1764/13 |
| | | 1200 mm | 1764/28 | - | 1764/40 | 1764/7 | - | 1764/16 |
| | | 1500 mm | 1764/31 | - | - | 1764/10 | - | 1764/19 |
| ∅ 14 x 14 mm | | 150 mm | 1764/74 | - | - | 1764/44 | - | - |
| | | 1000 mm | 1764/77 | 1764/95 | 1764/86 | 1764/47 | 1764/65 | 1764/56 |
| | | 1200 mm | 1764/80 | 1764/98 | 1764/89 | 1764/50 | 1764/68 | 1764/59 |
| | | 1500 mm | 1764/83 | 1764/101 | 1764/92 | 1764/53 | 1764/71 | 1764/62 |
| ∅ 14 mm | | 150 mm | 1764/23 | - | - | 1764/2 | - | - |
| | | 1000 mm | 1764/26 | - | 1764/35 | 1764/5 | - | 1764/14 |
| | | 1200 mm | 1764/29 | - | 1764/38 | 1764/8 | - | 1764/17 |
| | | 1500 mm | 1764/32 | - | 1764/41 | 1764/11 | - | 1764/20 |
| ∅ 16 x 16 mm | | 150 mm | 1764/75 | - | - | 1764/45 | - | - |
| | | 1000 mm | 1764/78 | 1764/96 | 1764/87 | 1764/48 | 1764/66 | 1764/57 |
| | | 1200 mm | 1764/81 | 1764/99 | 1764/90 | 1764/51 | 1764/69 | 1764/60 |
| | | 1500 mm | 1764/84 | 1764/102 | 1764/93 | 1764/54 | 1764/72 | 1764/63 |
| ∅ 16 mm | | 150 mm | 1764/24 | - | - | 1764/3 | - | - |
| | | 1000 mm | 1764/27 | - | 1764/36 | 1764/6 | - | 1764/15 |
| | | 1200 mm | 1764/30 | - | 1764/39 | 1764/9 | - | 1764/18 |
| | | 1500 mm | 1764/33 | - | 1764/42 | 1764/12 | - | 1764/21 |

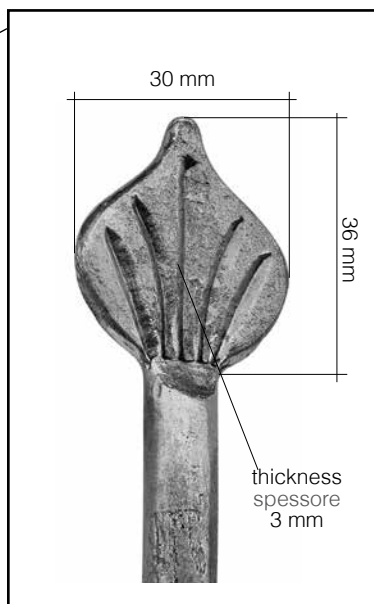

| Section - Sezione | Finish - Finitura | H | Art. |
|-------------------|---|---------|--------|
| Ø 10 mm | Plain - Liscio  | 150 mm | 1722/1 |
| | | 800 mm | 1722/2 |
| | | 1000 mm | 1722/3 |
| | | 1200 mm | 1722/4 |



Electrowelded pickets - Paletti elettrosaldati

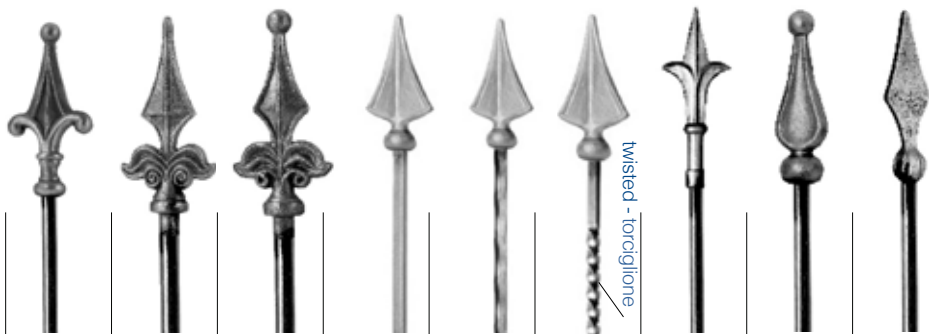

| Sec. - Sez. | Finish - Finitura | H | Art. | Art. | Art. | Art. | Art. | Art. | Art. | Art. | Art. |
|--------------|----------------------|---------|---------|---------|---------|--------|--------|--------|--------|--------|--------|
| ⌀ 12 x 12 mm | Plain - Liscio | 1000 mm | - | - | - | 727/24 | - | 727/26 | - | - | - |
| | | 1200 mm | - | - | - | 727/27 | - | 727/29 | - | - | - |
| | Hammered - Spigolato | 1000 mm | - | - | - | - | 727/25 | - | - | - | - |
| | | 1200 mm | - | - | - | - | 727/28 | - | - | - | - |
| Ø 12 mm | Plain - Liscio | 1000 mm | 1855/11 | 1855/23 | 1855/25 | - | - | - | 124/11 | 727/34 | 726/20 |
| | | 1200 mm | 1855/13 | 1855/24 | 1855/26 | - | - | - | 124/13 | 727/36 | 726/22 |
| ⌀ 14 x 14 mm | Plain - Liscio | 1000 mm | - | - | - | 727/18 | - | 727/20 | - | - | - |
| | | 1200 mm | - | - | - | 727/21 | - | 727/23 | - | - | - |
| | Hammered - Spigolato | 1000 mm | - | - | - | - | 727/19 | - | - | - | - |
| | | 1200 mm | - | - | - | - | 727/22 | - | - | - | - |
| Ø 14 mm | Plain - Liscio | 1000 mm | 1855/12 | - | - | - | - | - | 124/12 | 727/35 | 726/21 |
| | | 1200 mm | 1855/14 | - | - | - | - | - | 124/14 | 727/37 | 726/23 |
| ⌀ 16 x 16 mm | Plain - Liscio | 1000 mm | - | - | - | 727/12 | - | 727/14 | - | - | - |
| | | 1200 mm | - | - | - | 727/15 | - | 727/17 | - | - | - |
| | Hammered - Spigolato | 1000 mm | - | - | - | - | 727/13 | - | - | - | - |
| | | 1200 mm | - | - | - | - | 727/16 | - | - | - | - |
| Ø 16 mm | Plain - Liscio | 1000 mm | 1855/17 | - | - | - | - | - | - | - | - |
| | | 1200 mm | 1855/18 | - | - | - | - | - | - | - | - |
| Ø 18 mm | Plain - Liscio | 1000 mm | 1855/19 | - | - | - | - | - | - | 727/30 | - |
| | | 1200 mm | 1855/21 | - | - | - | - | - | - | 727/32 | - |
| Ø 20 mm | Plain - Liscio | 1000 mm | 1855/20 | - | - | - | - | - | - | 727/31 | - |
| | | 1200 mm | 1855/22 | - | - | - | - | - | - | 727/33 | - |

NEW



Spear point
Lancia
Art. 126/A/2



Spear points are electrowelded to the picket: electrical energy is used to obtain the union between metal parts, the junction between the components is precise and clean.

Le lance sono elettrosaldate ai paletti: sfruttando l'energia elettrica, per ottenere l'unione tra parti metalliche, la giunzione tra i componenti risulta precisa e pulita.

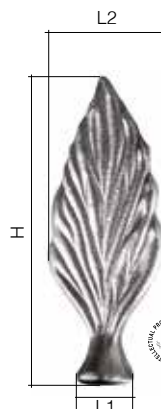

| Sec. - Sez. | Finish - Finitura | H | Art. |
|-------------|-----------------------|---------|----------|
| Ø 12 mm | Plain - Liscio | 1000 mm | 126/A/5 |
| | | 1200 mm | 126/A/6 |
| | Bark effect-Corteccia | 1000 mm | 126/A/3 |
| | | 1200 mm | 126/A/4 |
| Ø 14 mm | Plain - Liscio | 1000 mm | 126/A/9 |
| | | 1200 mm | 126/A/10 |
| | Bark effect-Corteccia | 1000 mm | 126/A/7 |
| | | 1200 mm | 126/A/8 |

| Picket section Sezione paletto | L1 | L2 | H |
|-----------------------------------|---------|-------|--------|
| Ø 12 mm | Ø 18 mm | 43 mm | 100 mm |
| Ø 14 mm | Ø 18 mm | 43 mm | 100 mm |



arteferro[®]
italian wrought iron

TECHNICAL SUPPORT ASSISTENZA TECNICA

Our technicians are available for a specialist consultation, and can develop made to customized projects. With our Gonzato Contract division, we can also supply turnkey solutions, from engineering to installation.

I nostri tecnici sono a disposizione per consulenze specializzate e sono in grado di sviluppare progetti su misura. Con la nostra divisione Gonzato Contract possiamo fornire anche soluzioni chiavi in mano, dalla progettazione all'installazione.

+39 0445 580 580

from Monday to Friday
dal Lunedì al Venerdì
08.00 -18.00 (GMT+1)

info@arteferro.com

www.arteferro.com

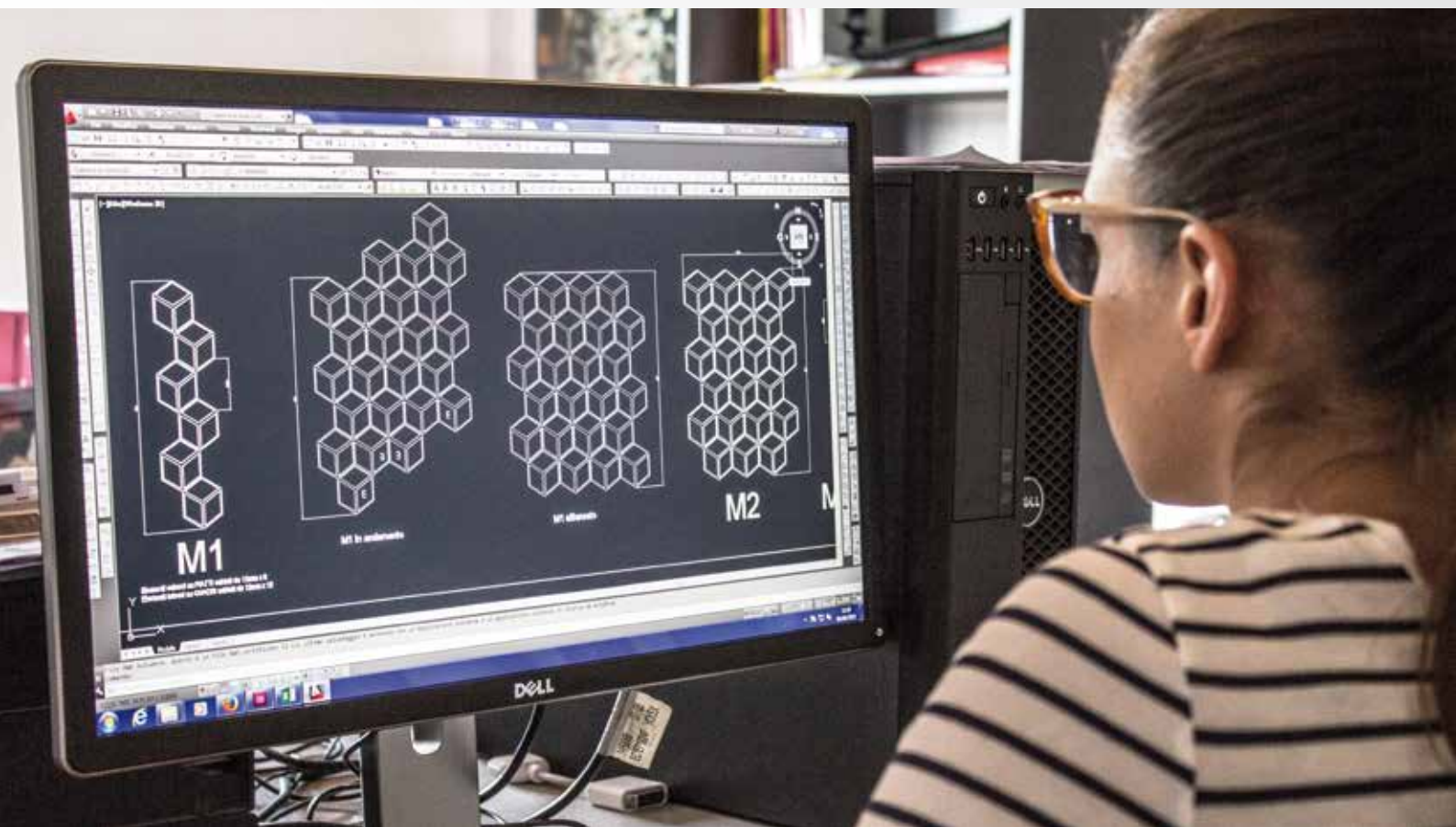



Arteferro spear points and tops reveal the nature of the buildings they protect. A historic symbol of protection for the most prestigious dwellings, you can embellish the pickets, posts and the columns of your fence. Designed to be positioned at the ends of the iron columns, these items reinforce and strengthen any wrought iron artefact.

Le lance ed i pomoli Arteferro rivelano la natura dell'edificio che proteggono. Simbolo storico di protezione delle dimore più prestigiose abbelliscono i paletti, i caposaldi e le colonne della tua recinzione. Ideati per essere posti alle estremità delle colonne in ferro, questi elementi conferiscono slancio e vigore ad ogni manufatto in ferro battuto.

LANCE, POMOLI E TERMINALI COLONNA SPEAR POINT AND POST TOPS



8.

Spear points and Post tops - Lance Terminali e Pomoli

| | | | | |
|---|--------------|---|---------------------------|---------|
| A | Spear points | A | Lance terminali | pag.174 |
| B | Tops | B | Pomoli | pag.181 |
| C | Post tops | C | Terminali a colonna | pag.183 |

HAND FORGED SPEAR POINTS
LANCE FORGIATE A MANO



Art. 120/1
Ø 40 mm
H 220 mm



Art. 120/2
Ø 35 mm
H 200 mm



Art. 120/3
Ø 30 mm
H 170 mm



Art. 1854/7
Ø 28 mm
H 160 mm



Art. 1854/10
Ø 30 mm
H 180 mm



Art. 1854/8
Ø 30 mm
H 160 mm



Art. 1854/9
Ø 32 mm
H 180 mm



Art. 121/5
Ø 25 x 25 mm
H 160 mm



Art. 121/6
Ø 30 x 30 mm
H 186 mm



Art. 121/8
Ø 30 x 30 mm
H 153 mm



Art. 167/15
Ø 30 x 30 mm
H 62 mm



Art. 129/15
Ø 32 mm
H 140 mm



Art. 121/4
Ø 33 mm
H 130 mm



Art. 723/5
Ø 28 mm
H 160 mm

Art. 121/7
Ø 40 x 40 mm
H 186 mm

Art. 121/9
Ø 40 x 40 mm
H 153 mm

Art. 167/16
Ø 40 x 40 mm
H 68 mm



NEW

Art. 121/10
Ø 50 x 50 mm
H 290 mm

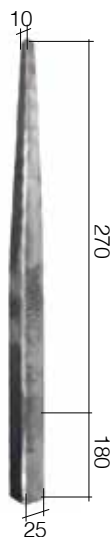

NEW

Art. 121/11
Ø 25 x 25 mm
H 450 mm

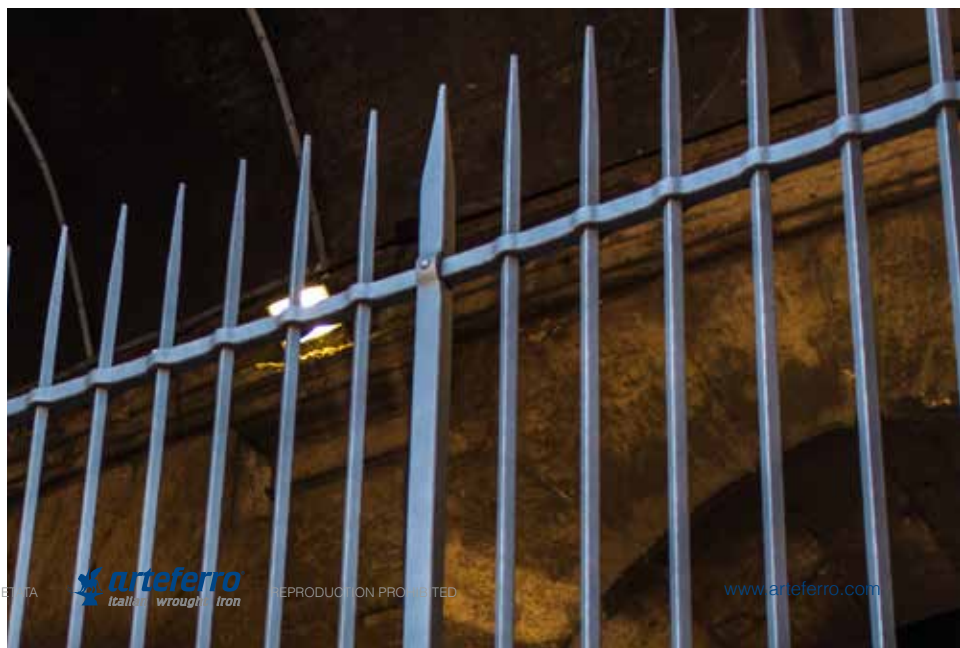

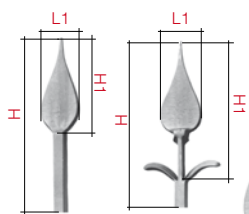

L1 x H1 x H
Hot forged
Fucinate a caldo



| Sec- Sez. | Art. | Art. | Art. | Art. | Art. | Art. | Art. | Art. |
|--------------|------------------------------------|-------------------------------------|------------------------------------|-------------------------------------|------------------------------------|-------------------------------------|------------------------------------|-----------------------------------|
| ∅ 12 x 12 mm | 129/10 43 x 115 x 165 mm | 722/5 43 x 132 x 150 mm | 1764/73 35 x 75 x 150 mm | 1764/43 35 x 85 x 150 mm | 129/8 43 x 145 x 200 mm | 722/3 43 x 132 x 200 mm | 129/12 46 x 165 x 200 mm | 722/1 46 x 180 x 200 mm |
| ∅ 14 x 14 mm | 129/9 50 x 128 x 180 mm | 722/6 50 x 143 x 170 mm | 1764/74 41 x 87 x 150 mm | 1764/44 39 x 85 x 150 mm | 129/7 50 x 156 x 200 mm | 722/4 50 x 143 x 220 mm | 129/11 52 x 185 x 230 mm | 722/2 52 x 200 x 230 mm |
| ∅ 16 x 16 mm | 129/16 54 x 135 x 170 mm | 722/7 53 x 145 x 210 mm | 1764/75 46 x 95 x 150 mm | 1764/45 46 x 105 x 150 mm | 129/19 53 x 170 x 220 mm | 128/D/9 53 x 170 x 240 mm | 129/20 H 230 mm | 722/8 H 240 mm |
| ∅ 12 mm | 1385/7 40 x 115 x 200 mm | 1385/13 40 x 125 x 200 mm | 1764/22 33 x 77 x 150 mm | 1764/1 35 x 80 x 150 mm | 1385/4 40 x 145 x 200 mm | 1385/10 40 x 150 x 200 mm | - | - |
| ∅ 14 mm | 1385/8 45 x 125 x 200 mm | 1385/14 45 x 140 x 200 mm | 1764/23 38 x 86 x 150 mm | 1764/2 37 x 85 x 150 mm | 1385/5 45 x 145 x 200 mm | 1385/11 45 x 163 x 200 mm | - | - |
| ∅ 16 mm | 1385/9 52 x 135 x 200 mm | 1385/15 51 x 140 x 200 mm | 1764/24 43 x 92 x 150 mm | 1764/3 42 x 100 x 150 mm | 1385/6 50 x 160 x 200 mm | 1385/12 50 x 175 x 200 mm | - | - |

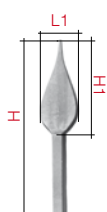

Hot forged
Fucinate a caldo

hammered
spigolato



| Sec- Sez. | Art. | Art. | Art. | Art. | Art. | Art. | Art. |
|--------------|-------------------------------------|------------------------------------|-----------------------------------|------------------------------------|------------------------------------|-----------------------------------|-----------------------------------|
| ∅ 12 x 12 mm | 1385/1 35 x 75 x 150 mm | - | - | - | - | 129/4 34 x 140 x 180 mm | 129/2 30 x 132 x 190 mm |
| ∅ 14 x 14 mm | 1385/2 40 x 90 x 150 mm | - | - | - | - | 129/3 38 x 148 x 190 mm | 129/1 40 x 147 x 200 mm |
| ∅ 16 x 16 mm | 1385/3 42 x 100 x 140 mm | - | - | - | - | - | - |
| ∅ 20 x 20 mm | 1385/16 51 x 125 x 250 mm | 129/17 60 x 147 x 250 mm | - | - | - | - | - |
| ∅ 30 x 30 mm | 1385/17 80 x 200 x 300 mm | 129/18 72 x 165 x 250 mm | - | - | - | - | - |
| ∇ 20 x 6 mm | - | - | 1765/4 32 x 90 x 200 mm | - | - | - | - |
| ∇ 30 x 8 mm | - | - | - | 1765/2 51 x 135 x 250 mm | 1765/3 53 x 165 x 250 mm | - | - |

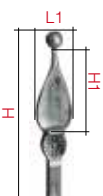

Cold stamped
Stampate a freddo



| Sec- Sez. | Art. | Art. | Art. |
|--------------|-------------------------------------|-------------------------------------|-------------------------------------|
| ∅ 12 x 12 mm | 1765/11 31 x 130 x 200 mm | 1765/26 31 x 130 x 200 mm | 1765/41 31 x 130 x 200 mm |
| ∅ 14 x 14 mm | 1765/16 37 x 130 x 200 mm | 1765/31 37 x 130 x 200 mm | 1765/46 37 x 130 x 200 mm |
| ∅ 16 x 16 mm | 1765/21 40 x 130 x 200 mm | 1765/36 40 x 130 x 200 mm | 1765/51 40 x 130 x 200 mm |



Spear points - Lance terminali

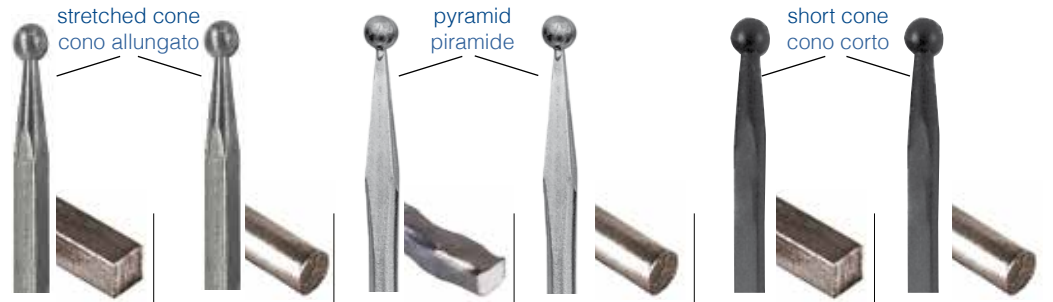

| Section Sezione | Height Altezza | Art. | Art. | Art. | Art. | Art. | Art. |
|--------------------|-------------------|---------|--------|---------|---------|----------|----------|
| 12 x 12 mm | 200 mm | 1759/45 | - | 1382/19 | 1382/13 | 118/C/63 | 118/C/66 |
| | 250 mm | - | - | - | - | - | - |
| 14 x 14 mm | 200 mm | 1759/46 | - | 1382/20 | 1382/14 | 118/C/64 | 118/C/67 |
| | 250 mm | - | - | - | - | - | - |
| 16 x 16 mm | 200 mm | 1759/47 | - | - | - | 118/C/65 | 118/C/68 |
| | 250 mm | - | - | - | - | - | - |
| 25 x 25 mm | 200 mm | 1382/2 | - | - | - | - | - |
| | 250 mm | - | - | - | - | - | - |
| 30 x 30 mm | 200 mm | 1382/3 | - | - | - | - | - |
| | 250 mm | - | 1382/4 | - | - | - | - |
| 40 x 40 mm | 200 mm | 1382/1 | - | - | - | - | - |
| | 250 mm | - | 1382/5 | - | - | - | - |



| Section Sezione | Height Altezza | Art. | Art. | Art. | Art. | Art. |
|--------------------|-------------------|----------|----------|--------|--------|--------|
| 12 x 12 mm | 250 mm | - | - | - | - | - |
| | 300 mm | 132/C/12 | 132/C/18 | 1381/1 | 1381/7 | - |
| 14 x 14 mm | 250 mm | - | - | - | - | 1380/2 |
| | 300 mm | 132/C/13 | 132/C/19 | 1381/2 | 1381/8 | - |
| 16 x 16 mm | 250 mm | - | - | - | - | - |
| | 300 mm | 132/C/13 | 132/C/20 | 1381/3 | 1381/9 | - |
| 20 x 20 mm | 250 mm | - | - | - | - | 1380/1 |
| | 300 mm | 132/C/15 | 132/C/21 | - | - | - |

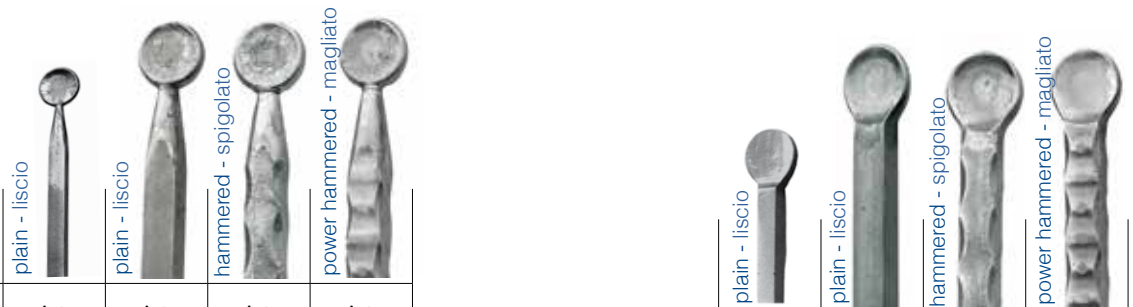

| Section Sezione | Height Altezza | Art. | Art. | Art. | Art. |
|--------------------|-------------------|---------|---------|---------|---------|
| 12 x 12 mm | 200 mm | 1754/45 | - | - | - |
| 14 x 14 mm | 200 mm | 1754/46 | - | - | - |
| 16 x 16 mm | 200 mm | 1754/47 | - | - | - |
| 25 x 25 mm | 300 mm | - | 1766/33 | 1766/35 | 1766/37 |
| 30 x 30 mm | 300 mm | - | 1766/34 | 1766/36 | 1766/38 |

| Section Sezione | Height Altezza | Art. | Art. | Art. | Art. |
|--------------------|-------------------|-------|---------|---------|---------|
| 12 x 12 mm | 100 mm | 129/6 | - | - | - |
| 14 x 14 mm | 110 mm | 129/5 | - | - | - |
| 25 x 25 mm | 300 mm | - | 1766/39 | 1766/41 | 1766/43 |
| 30 x 30 mm | 300 mm | - | 1766/40 | 1766/42 | 1766/44 |

STAMPED SPEAR POINTS - LANCE STAMPATE

Spear points - Lance terminali



New



18

Art. 126/A/2

H 100 mm

L 43 mm

base Ø 18 mm

BEST PRICE



10.000.000

are the spear points that are shipped from our factories every year, and go on to adorn the most beautiful villas in the world

sono le lance che escono ogni anno dai nostri stabilimenti e vanno ad ornare le più belle ville del mondo



Not all of the Arteferro items are available in **Arteferro Quick**, just a special selection. Find out about the entire range in the catalogue

In **Arteferro Quick** non sono presenti tutti gli articoli Arteferro, ma solo una speciale selezione. Scopri la gamma completa nel catalogo

Compendium





Art. 726/4
Ø 24 mm
H 125 mm
Art. 126/9
Ø 20 mm
H 90 mm



Art. 726/3
Ø 30 mm
H 180 mm



Art. 126/6
Ø 34 mm
H 190 mm
Art. 126/19
Ø 25 mm
H 140 mm
Art. 126/20
Ø 30 mm
H 160 mm



Art. 122/A/1
Ø 35 mm
H 200 mm

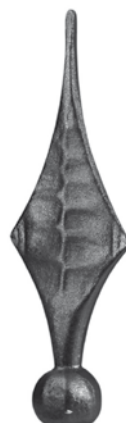

Art. 1855/10
Ø 30 mm
H 170 mm



Art. 1855/9
Ø 35 mm
H 200 mm

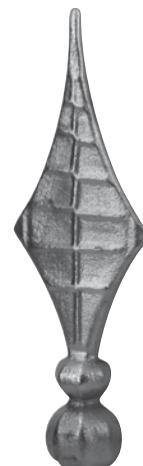

Art. 1855/8
Ø 40 mm
H 220 mm



Art. 125/1
Ø 35 mm
H 125 mm



Art. 125/2
Ø 14 x 14 mm
H 135 mm



Art. 1386/12
Ø 32 mm
60 x 125 mm
Art. 1386/13
Ø 25 mm
55 x 110 mm



Art. 727/1
Ø 32 mm
70 x 140 mm
Art. 727/2
Ø 30 mm
65 x 125 mm
Art. 727/3
Ø 25 mm
55 x 110 mm



Art. 1386/11
Ø 16 mm
650 x 150 mm



Art. 124/6
Ø 15 mm
H 155 mm



Art. 725/1
Ø 30 mm
H 165 mm



Art. 727/6
Ø 24 mm
60 x 160 mm
Art. 727/5
Ø 27 mm
70 x 185 mm
Art. 727/4
Ø 30 mm
80 x 210 mm



Art. 127/1
Ø 10 x 10 mm
H 70 mm
Art. 127/2
Ø 12 x 12 mm
H 70 mm

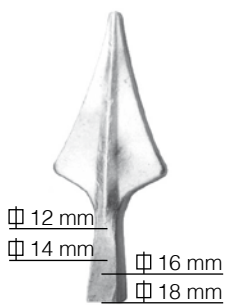

Art. 126/D/1
Ø 12 mm
Ø 14 mm
Ø 16 mm
Ø 18 mm
Ø 18 x 18 mm
60 x 155 mm



Art. 123/6
Ø 35 mm
H 180 mm



Art. 726/1
Ø 12 x 12 mm
H 185 mm



Art. 726/2
Ø 12 x 12 mm
H 165 mm



Art. 1386/6
Ø 12 x 12 mm
H 120 mm
Art. 1386/5
Ø 14 x 14 mm
H 140 mm

STAMPED SPEAR POINTS - LANCE STAMPATE

Spear points - Lance terminali



Art. 1386/10
Ø 21,5 mm
60 x 115 mm



Art. 126/8
Ø 20 mm
H 112 mm
Art. 126/21
Ø 25 mm
H 135 mm



Art. 1855/5
Ø 12 mm
60 x 135 mm



Art. 1855/4
Ø 12 mm
60 x 135 mm



Art. 726/6
Ø 22 mm
H 120 mm
Art. 726/7
Ø 26 mm
H 135 mm



Art. 1855/1
Ø 24 mm
65 x 128 mm
Art. 1855/2
Ø 25 mm
70 x 140 mm
Art. 1855/3
Ø 32 mm
86 x 170 mm



Art. 1386/7
Ø 16 mm
70 x 155 mm
Art. 1386/8
Ø 12 mm
60 x 130 mm



Art. 124/1
Ø 12 mm
H 125 mm
Art. 124/2
Ø 15 mm
H 160 mm
Art. 124/9
Ø 20 mm
H 190 mm



Art. 124/7
Ø 14 mm
H 127 mm



Art. 124/3
Ø 12 mm
H 125 mm
Art. 124/4
Ø 15 mm
H 160 mm
Art. 124/5
Ø 16,5 mm
H 190 mm



Art. 126/B/1
Ø 19 mm
82 x 195 mm
Art. 126/B/2
Ø 16 mm
68 x 160 mm
Art. 126/B/3
Ø 13 mm
54 x 130 mm



Art. 124/8
Ø 15 mm
72 x 215 mm



Art. 126/13
Ø 16 mm
64 x 170 mm
Art. 126/14
Ø 16 mm
55 x 140 mm



Art. 126/B/6
Ø 20 mm
45 x 80 mm
Art. 126/B/7
Ø 25 mm
64 x 125 mm
Art. 126/B/8
Ø 38 mm
80 x 140 mm



Art. 1387/1
Ø 23 x 23 mm
H 75 mm
Art. 1387/2
Ø 27 x 27 mm
H 100 mm



Art. 1387/3
Ø 20 x 20 mm
H 133 mm



Art. 727/7
Ø 40 x 40 mm
120 x 200 mm
Art. 727/8
Ø 32 x 32 mm
90 x 160 mm
Art. 727/9
Ø 25 x 25 mm
70 x 120 mm





Art. 726/12
Ø 18 mm
H 110 mm



Art. 726/10
H 100 mm
base Ø 12 mm
Art. 726/11
H 125 mm
base Ø 15 mm



Art. 126/E/1
Ø 15 mm
55 x 150 mm



Art. 126/A/1
Ø 15 mm
68 x 150 mm



Art. 126/B/9
Ø 22 mm
66 x 165 mm



Art. 726/9
Ø 35 mm
H 190 mm



Art. 725/2
Ø 32 mm
H 225 mm



Art. 724/1
Ø 35 mm
H 295 mm



Art. 126/18
Ø 40 x 40 mm
H 150 mm



Art. 123/5
Ø 25 x 25 mm
H 160 mm



Art. 123/3
Ø 32 mm
H 130 mm



Art. 1386/2
Ø 32 x 32 mm
H 135 mm



Art. 1386/1
Ø 40 x 40 mm
H 150 mm
Art. 1386/2
Ø 32 x 32 mm
H 135 mm
Art. 1386/3
Ø 25 x 25 mm
H 125 mm
Art. 1386/4
Ø 20 x 20 mm
H 100 mm



Art. 126/2
Ø 20 x 20 mm
H 130 mm
Art. 126/15
Ø 30 x 30 mm
H 160 mm
Art. 126/16
Ø 40 x 40 mm
H 190 mm



Art. 126/1
Ø 10 x 10 mm
H 140 mm



Art. 727/10
Ø 33 mm
40 x 150 mm
Art. 727/11
Ø 30 mm
35 x 120 mm



Art. 126/C/7
Ø 18 mm
H 125 mm
Art. 126/C/8
Ø 12 x 12 mm
H 100 mm



STAMPED TOPS - POMOLI STAMPATI

Tops - Pomoli

cast iron
ghisa

Art. 128/C/2
base Ø 160 mm
H 405 mm



Art. 749/8
base Ø 42 mm
H 85 mm
Art. 749/9
base Ø 55 mm
H 120 mm
Art. 749/10
base Ø 70 mm
H 150 mm



| Art. | Sphere diam. sfera | Diam. base diam. | H |
|--------|--------------------|------------------|--------|
| 1404/1 | 110 mm | 90 mm | 140 mm |
| 1404/2 | 90 mm | 70 mm | 125 mm |
| 1404/3 | 70 mm | 55 mm | 100 mm |
| 1404/4 | 55 mm | 45 mm | 85 mm |



| Art. | Sphere diam. sfera | Diam. base diam. | H |
|--------|--------------------|------------------|--------|
| 1404/5 | 95 mm | 100 x 100 mm | 150 mm |
| 1404/6 | 85 mm | 80 x 80 mm | 120 mm |
| 1404/7 | 70 mm | 60 x 60 mm | 105 mm |
| 1404/8 | 50 mm | 40 x 40 mm | 75 mm |
| 1404/9 | 30 mm | 25 x 25 mm | 45 mm |



Art. 749/13
base Ø 43 mm
H 85 mm
Art. 749/14
Base Ø 49 mm
H 125 mm



Art. 749/18
base Φ 40 x 40 mm
H 85 mm
Art. 749/19
base Φ 60 x 60 mm
H 125 mm



| Art. | Sphere diam. sfera | Diam. base diam. | H |
|--------|--------------------|------------------|--------|
| 128/31 | - | 100 mm | 180 mm |
| 128/35 | - | 50 mm | 90 mm |

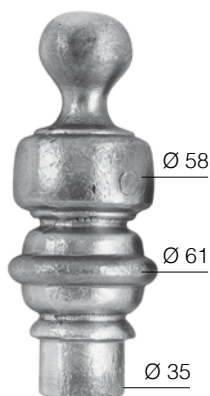

Art. 749/1
base Ø 35 mm
H 155 mm



Art. 749/2
base Ø 22 mm
H 95 mm



FORGED TOPS - POMOLI FORGIATI

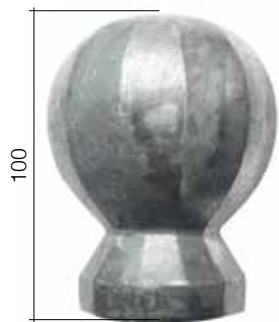

Art. 749/22
 Ø 70 mm
 base Ø 51 mm



Art. 116/A/20
 sfera Ø 55 mm
 base Ø 38 mm



Art. 116/A/21
 sfera Ø 40 mm
 base Ø 26 mm

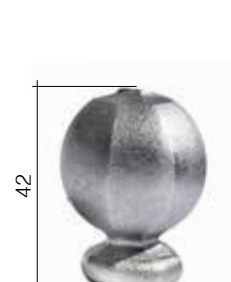

Art. 116/A/22
 sfera Ø 30 mm
 base Ø 22 mm

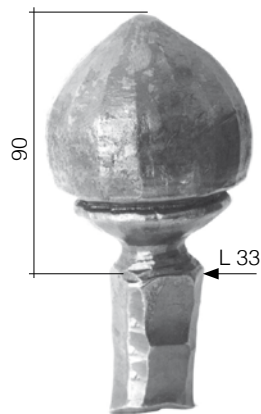

Art. 113/9
 Ø 75 mm

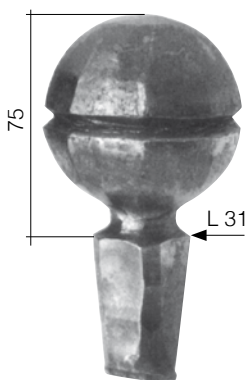

Art. 113/10
 Ø 70 mm

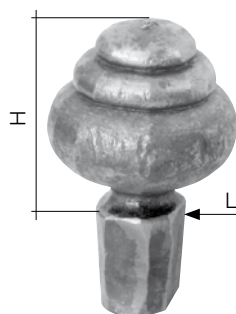

Art. 116/A/17
 Ø 72 mm
 L 40 x H 75 mm
 Art. 116/A/19
 Ø 55 mm
 L 30 x H 65 mm

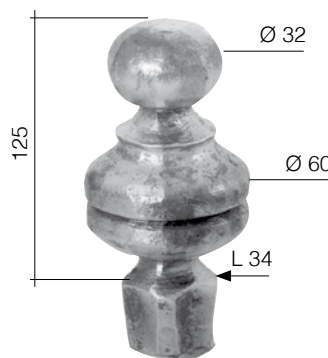

Art. 116/A/18
 Ø 60 mm



Art. 595/7/S
 Ø 20 mm
 H 150 mm

NEW

WELDED TOPS - POMOLI SALDATI



Art. 1400/2
 H 130 mm
 base Ø 30 mm
 Ø 120 mm



Art. 1400/1
 H 100 mm
 base Ø 25 mm
 Ø 160 mm



Art. 1398/1
 H 75 mm
 Ø 120 mm

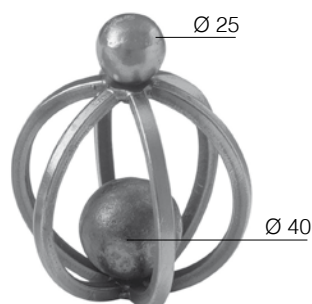

Art. 1398/2
 Ø 6 x 6 mm
 H 115 mm
 Ø 90 mm



Art. 1399/1
 H 140 mm
 base Ø 25 mm
 Ø 115 mm





Hollow sphere
Sfera vuota
Art. 1165/6

for tube - per tubo
Ø 30 x 30 mm
Ø 40 mm
Art. 1165/5
for tube - per tubo
Ø 40 x 40 mm
Ø 50 mm



Entirely welded sheet metal
Lamiera saldata interamente

Art. 1858/1

for tube - per tubo
Ø 50 x 50 mm
H 70 mm

Art. 1858/2

for tube - per tubo
Ø 60 x 60 mm
H 84 mm

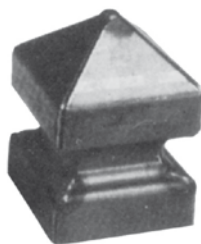

Steel sheet
Lamiera puntata
Art. 167/11

for tube - per tubo
Ø 80 x 80 mm
H 115 mm

Art. 167/14

for tube - per tubo
Ø 150 x 150 mm
H 192 mm



Hand forged
Forgiato a mano

Art. 167/15
Ø 30 x 30 mm
H 62 mm

Art. 167/16
Ø 40 x 40 mm
H 68 mm

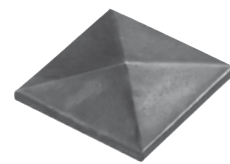

Art. 167/3

for tube - per tubo
Ø 30 x 30 mm

Art. 167/4

for tube - per tubo
Ø 40 x 40 mm

Art. 167/6

for tube - per tubo
Ø 60 x 60 mm

Art. 167/8

for tube - per tubo
Ø 100 x 100 mm



Hand forged
Forgiato a mano

Art. 178/35

Ø 40 mm
plain - liscio
120 x 300 mm

Art. 178/36

Ø 30 mm
120 x 300 mm
plain - liscio



Hand forged
Forgiato a mano

Art. 593/3/S1

Ø 40 mm
spigolato - spigolato
130 x 350 mm

Art. 593/3/S4

Ø 40 mm
plain - liscio
130 x 350 mm



BEST PRICE

Art. 593/10
Ø 50 x 6 mm
plain - liscio
70 x 300 mm

Art. 593/11
Ø 60 x 6 mm
plain - liscio
70 x 300 mm



NEW

Art. 6112/4/S
Ø 25 mm
L 150 x 250 mm



NEW

Art. 596/4/S3
Ø 25 mm
L150 x H 300 mm



plain

liscio

Art. 178/20
Ø 30 x 30 mm
H 300 mm
Art. 178/29
Ø 40 x 40 mm
H 300 mm



power
hammered

magliato

Art. 178/24
Ø 30 x 30 mm
H 300 mm
Art. 178/31
Ø 40 x 40 mm
H 300 mm



hammered

spigolato

Art. 178/22
Ø 30 x 30 mm
H 300 mm
Art. 178/30
Ø 40 x 40 mm
H 300 mm

GONZATO

C O N T R A C T

We forge your dreams

Gonzato Contract is a division of Ind.i.a. that deals with special supplies in wrought iron, stainless steel or any other metal, for prestigious private homes, public buildings, hotels, community centres and for all types of commissions that demand a custom made approach, from design to installation.

Mission: to meet the needs of designers, contractors and private individuals who are looking for a single supplier who can provide them with high quality metal products and a high level of service.

Gonzato Contract si occupa di forniture speciali, in ferro battuto, in acciaio inox o in qualsiasi altro metallo, per prestigiose proprietà private, edifici pubblici, alberghi, spazi comunitari e per ogni tipo di commissione che richieda un approccio custom made, dalla progettazione all'installazione.

Mission: rispondere alle esigenze di progettisti, contractors e privati alla ricerca di un unico interlocutore che fornisca loro prodotti in metallo di elevata qualità e un servizio di alto livello.



www.gonzatocontract.com



GONZATO GROUP

Gonzato Contract is a division of Ind.i.a. spa (Gonzato Group)
Via Vicenza, 6/14 (SP46) – 36034 Malo (Vicenza) Italy
Tel. +39 0445 580 580 • Fax +39 0445 580 874
info@gonzatocontract.com • www.gonzatocontract.com

 **ind.i.a.**





ROSACES

Arteferro rosaces are particularly elaborate decorative elements that can be used to embellish external and internal environments like gates and grilles, balustrades, stairs, walls and skylights too.













I rosoni Arteferro sono elementi decorativi particolarmente elaborati che possono essere impiegato per abbellire ambienti esterni ed interni come cancelli ed inferriate ma anche parapetti, scale, pareti e lucernari.

ROSONI

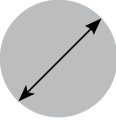











The rosaces have been listed by diameter:
after identifying this dimension, it is enough to
choose the section and then the art type

I rosioni sono stati catalogati per diametro:
identificata tale dimensione, basterà scegliere la
sezione e quindi la tipologia artistica.

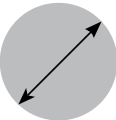











from-da Ø 112 mm
to-a Ø 250 mm

| | | | | | | |
|---|---|---|---|--|---|---|
| | plain liscio | notched tacchettato | notched tacchettato | notched tacchettato | notched tacchettato | notched tacchettato |
| |  |  |  |  |  |  |
| | stamped stampato | without collars senza fascette | without collars senza fascette | without collars senza fascette | without collars senza fascette | without collars senza fascette |
|  |  |  |  |  |  |  |
| Section-Sezione | Ø 112 mm | Ø 153 mm | Ø 160 mm | Ø 225 mm | Ø 250 mm | Ø 250 mm |
| | Art. | Art. | Art. | Art. | Art. | Art. |
| Φ 6 x 6 mm | - | 30/4 | - | - | - | - |
| Φ 8 x 8 mm | - | - | - | 22/A/2 | 20/5 | 20/6 |
| Φ 14 x 14 mm | 1393/2 | - | - | - | - | - |
| ∇ 10 x 5 mm | - | - | 30/7 | - | - | - |

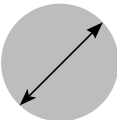
Ø 250 mm

| | | | | | | |
|---|--|--|--|---|--|--|
| | notched tacchettato | notched tacchettato | notched tacchettato | notched tacchettato | notched tacchettato | notched tacchettato |
| |  |  |  |  |  |  |
| | with collars con fascette | without collars senza fascette | without collars senza fascette | without collars senza fascette | without collars senza fascette | without collars senza fascette |
|  |  |  |  |  |  |  |
| Section-Sezione | Ø 250 mm | Ø 250 mm | Ø 250 mm | Ø 250 mm | Ø 250 mm | Ø 250 mm |
| | Art. | Art. | Art. | Art. | Art. | Art. |
| Φ 6 x 6 mm | - | - | - | - | - | - |
| Φ 8 x 8 mm | - | - | - | 18/A/1 | 18/1 | 18/2 |
| ∇ 10 x 5 mm | 23/1 | - | - | - | - | - |
| ∇ 20 x 4 mm | - | 23/3 | 23/2 | - | - | - |

from-da Ø 250 mm
to-a Ø 260 mm

| | | | | | | |
|---|---|---|---|--|---|---|
| | notched tacchettato | notched tacchettato | notched tacchettato | plain liscio | plain liscio | notched tacchettato |
| |  |  |  |  |  |  |
| | without collars senza fascette | without collars senza fascette | without collars senza fascette | without collars senza fascette | without collars senza fascette | without collars senza fascette |
|  |  |  |  |  |  |  |
| Section-Sezione | Ø 250 mm | Ø 250 mm | Ø 250 mm | Ø 250 mm | 250 x 250 mm | Ø 260 mm |
| | Art. | Art. | Art. | Art. | Art. | Art. |
| Φ 8 x 8 mm | 17/1 | 17/2 | 16/3 | 21/4 | - | - |
| ∇ 10 x 5 mm | - | - | - | - | - | - |
| ∇ 12 x 6 mm | - | - | - | - | 33/2 | - |
| ∇ 16 x 4 mm | - | - | - | - | 33/3 | - |
| Ø 8 mm | - | - | - | - | - | 26/2 |
| Ø 10 mm | - | - | - | - | - | 26/1 |

from-da Ø 260 mm
to-a Ø 290 mm











| | | | | | | |
|-----------------|--|---|--|--|--|--|
| | plain liscio with collars con fascette | plain liscio without collars senza fascette | plain liscio with collars con fascette | plain liscio with collars con fascette | plain liscio with collars con fascette | plain liscio with collars con fascette |
| Section-Sezione | Ø 260 mm | Ø 260 mm | Ø 270 mm | Ø 270 mm | Ø 275 mm | Ø 290 mm |
| Art. | Art. | Art. | Art. | Art. | Art. | Art. |
| Ø 8 x 8 mm | 16/1 | 16/2 | - | - | - | - |
| Ø 12 x 12 mm | - | - | 1014/1 | - | - | - |
| Ø 10 x 5 mm | - | - | - | - | - | 22/3 |
| Ø 14 x 8 mm | - | - | - | - | 21/5 | - |
| Ø 12 mm | - | - | 1014/2 | 1014/3 | - | - |

from-da Ø 295 mm
to-a Ø 380 mm



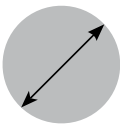

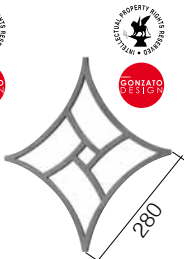
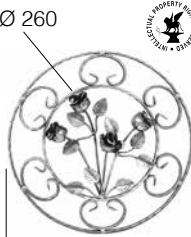

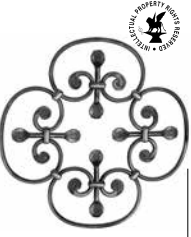
| | | | | | |
|-----------------|--|---|--|--|--------------|
| | plain liscio Rosettes 116/A/4 on both sides Rosette 116/A/4 sui 2 lati | notched tacchettato with collars con fascette | notched tacchettato without collars senza fascette | plain liscio with collars con fascette | plain liscio |
| Section-Sezione | Ø 295 mm | Ø 300 mm | Ø 300 mm | 320 x 320 mm | Ø 380 mm |
| Art. | Art. | Art. | Art. | Art. | Art. |
| Ø 8 x 8 mm | - | 18/3 | 18/4 | - | - |
| Ø 12 x 12 mm | 1013/2 | - | - | - | - |
| Ø 10 x 5 mm | - | - | - | - | 24/C/2 |
| Ø 12 x 6 mm | - | - | - | GD270/2 | - |
| Ø 12 mm | 1013/1 | - | - | - | - |





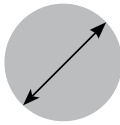

from-da Ø 360 mm
to-a Ø 380 mm

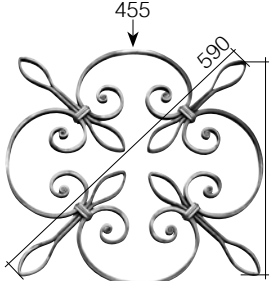
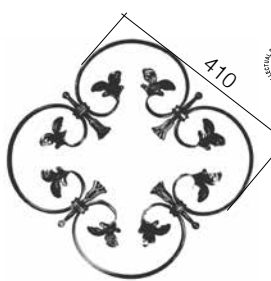
| | | | | | |
|-----------------|---|---|--|---|---|
| | plain liscio without collars senza fascette | plain liscio without collars senza fascette | notched tacchettato without collars senza fascette | notched tacchettato with collars con fascette | notched tacchettato with collars con fascette |
| Section-Sezione | Ø 360 mm | Ø 370 mm | Ø 380 mm | Ø 380 mm | Ø 380 mm |
| Art. | Art. | Art. | Art. | Art. | Art. |
| Ø 8 x 8 mm | - | - | - | - | - |
| Ø 12 x 12 mm | - | - | - | - | - |
| Ø 10 x 5 mm | - | - | 454/3 | 24/1 | 24/2 |
| Ø 12 x 6 mm | 1009/1 | 1009/2 | - | - | - |
| Ø 12 mm | - | - | - | - | - |

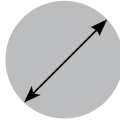

| | | | | | | |
|-----------------------------------|---|---|---|--|---|---|
| | plain liscio | plain liscio | diamond diamantato | plain liscio | plain liscio | plain liscio |
| |  |  |  |  |  |  |
| | 190 | | Ø 260 | | | |
| from-da Ø 325 mm to-a Ø 440 mm |  |  |  |  |  |  |
| Section-Sezione | Ø 325 mm | Ø 395 mm | Ø 415 mm | Ø 420 mm | Ø 440 mm | Ø 440 mm |
| | Art. | Art. | Art. | Art. | Art. | Art. |
| Ø 12 x 12 mm | - | GD211/2 | - | - | - | - |
| Ø 14 x 14 mm | - | - | - | - | - | 1659/1 |
| Ø 12 x 6 mm | - | - | 720/2 | 450/1 | - | - |
| Ø 14 x 8 mm | GD187/2 | - | - | - | - | - |
| Ø 10 mm | - | - | - | - | 1011/1 | - |

Rosettes 116/A/3 on both sides
Rosette 116/A/3 sui 2 lati

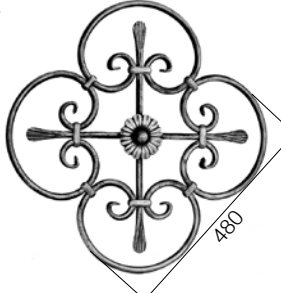
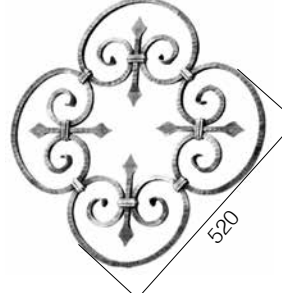

| | | | | |
|-----------------------------------|---|--|--|---|
| | plain liscio | plain liscio | plain liscio | plain liscio |
| |  |  |  |  |
| | | 455 | | 470 |
| from-da Ø 450 mm to-a Ø 470 mm |  |  |  |  |
| Section-Sezione | Ø 450 mm | Ø 455 mm | Ø 460 mm | Ø 470 mm |
| | Art. | Art. | Art. | Art. |
| Ø 12 x 6 mm | - | - | 24/B/1 | - |
| Ø 14 x 8 mm | - | 1667/1 | - | 1667/2 |
| Ø 12 mm | 455/2 | - | - | - |

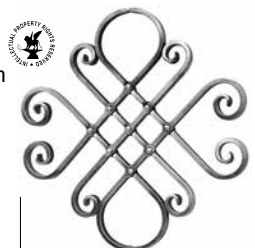
| | | | | |
|---|---|---|--|---|
| | plain liscio | plain liscio | martellato hammered | plain liscio |
| |  |  |  |  |
| inner circle cerchio interno Ø 450 mm | | | | |
| from-da Ø 500 mm to-a Ø 610 mm |  |  |  |  |
| Section-Sezione | Ø 500 mm | Ø 565 mm | Ø 600 mm | Ø 610 mm |
| | Art. | Art. | Art. | Art. |
| Ø 12 x 12 mm | - | - | 24/3 | - |
| Ø 14 x 14 mm | - | - | - | 452/1 |
| Ø 14 x 8 mm | GD268/1 | - | - | - |
| Ø 14 mm | - | 446/4 | - | - |

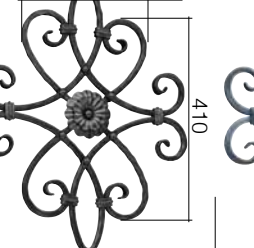
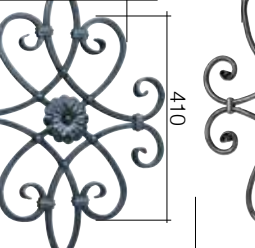
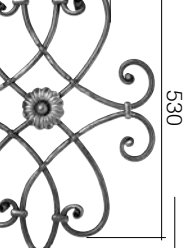
Rosettes 116/A/3 on both sides
Rosette 116/A/3 sui 2 lati

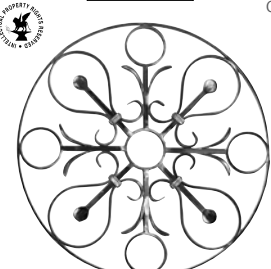
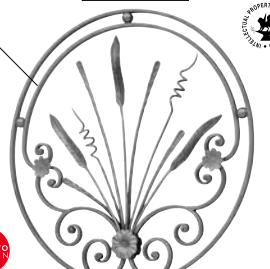
| | plain liscio | plain liscio | hammered spigolato | plain liscio | plain liscio |
|-----------------------------------|---|---|--|---|---|
| from-da L 400 mm to-a L 610 mm |  |  |  |  |  |
| Section-Sezione | L 410 x H 400 mm | L 400 x H 575 mm | L 430 x H 530 mm | L 430 x H 530 mm | L 475 x H 610 mm |
| | Art. | Art. | Art. | Art. | Art. |
| ∅ 12 x 12 mm | - | - | 26/C/1 | 1641/2 | - |
| ∅ 14 x 14 mm | - | - | 1641/6 | 1641/5 | - |
| ∅ 16 x 8 mm | 1657/1 | 1657/4 | - | - | - |
| ∅ 14 mm | - | - | - | - | 1641/1 |

| | power hammered magliato | plain liscio | plain liscio |
|-----------------------------------|--|---|--|
| from-da ∅ 610 mm to-a ∅ 620 mm |  |  |  |
| Section-Sezione | ∅ 610 mm | ∅ 615 mm | ∅ 620 mm |
| | Art. | Art. | Art. |
| ∅ 14 x 14 mm | 459/1 | - | - |
| ∅ 12 x 6 mm | - | 1024/1 | - |
| ∅ 14 x 8 mm | - | - | GD268/2 |

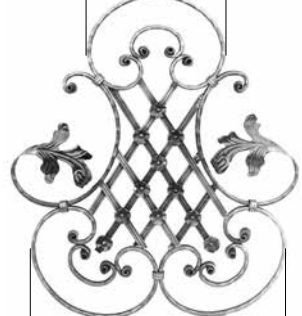
| | hammered spigolato | hammered spigolato | hammered spigolato |
|-----------------------------------|---|--|---|
| from-da L 515 mm to-a L 710 mm |  |  |  |
| Section-Sezione | L 515 x H 670 mm | L 515 x H 690 mm | L 640 x H 710 mm |
| | Art. | Art. | Art. |
| ∅ 14 x 14 mm | 720/1 | 719/1 | - |
| ∅ 16 x 8 mm | - | - | 719/2 |
| ∅ 14 mm | - | - | - |

plain
liscio



plain
liscio



plain
liscio



from-da Ø 470 mm
to-a Ø 840 mm

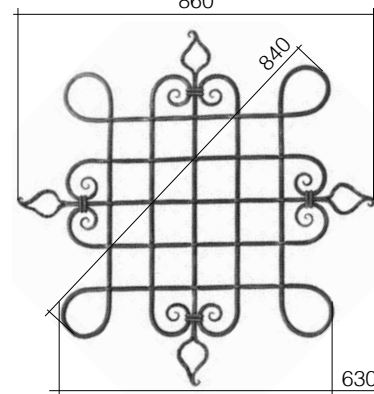
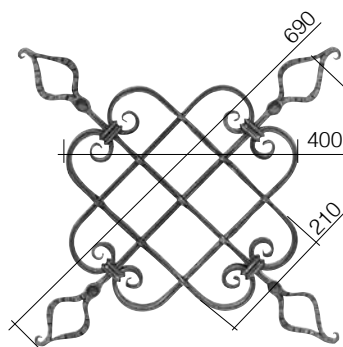
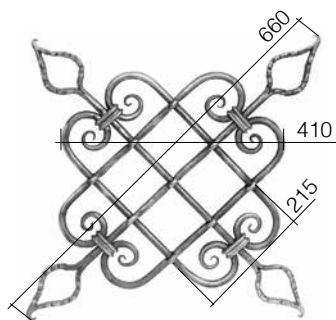
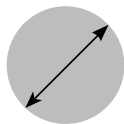

| | | | |
|-----------------|----------|----------|----------|
| Section-Sezione | Ø 660 mm | Ø 690 mm | Ø 840 mm |
| | Art. | Art. | Art. |
| ⊘ 16 x 8 mm | - | 680/1 | - |
| Ø 12 mm | 679/1 | - | 679/2 |
| Ø 14 mm | - | - | - |

plain
liscio



plain
liscio



plain
liscio



plain
liscio



hammered
spigolato



NEW

DESIGNER

DESIGNER

from-da Ø 600 mm
to-a Ø 910 mm

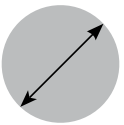

⊘ 16 x 8 mm ⊘ 8 x 8 mm

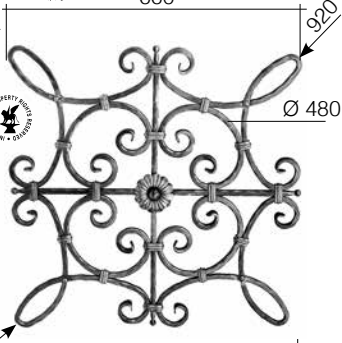
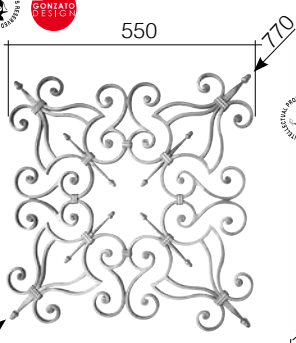
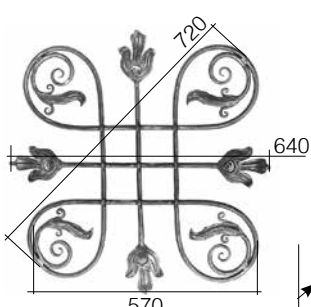
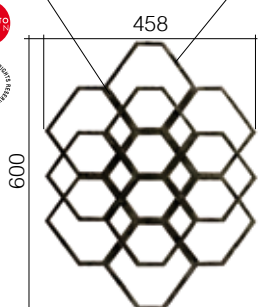

| | | | | |
|-----------------|----------|----------|----------|----------|
| Section-Sezione | Ø 600 mm | Ø 720 mm | Ø 770 mm | Ø 920 mm |
| | Art. | Art. | Art. | Art. |
| ⊘ 8 x 8 mm | GD299/4 | - | - | - |
| ⊘ 12 x 12 mm | - | - | - | 480/1 |
| ⊘ 14 x 8 mm | - | - | GD151/2 | - |
| Ø 12 mm | - | 679/3 | - | - |





In 1972
the first rosace
was sold as item no. 31,
today on sale as
art.no.18/2

Nel 1972
fu venduto
il primo rosone
art. 31 oggi in vendita
come art. 18/2

plain - liscio



EXTENSIBLE ROSACES
"ARTICULATED"
ROSONI ESTENSIBILI
"SNODATI"

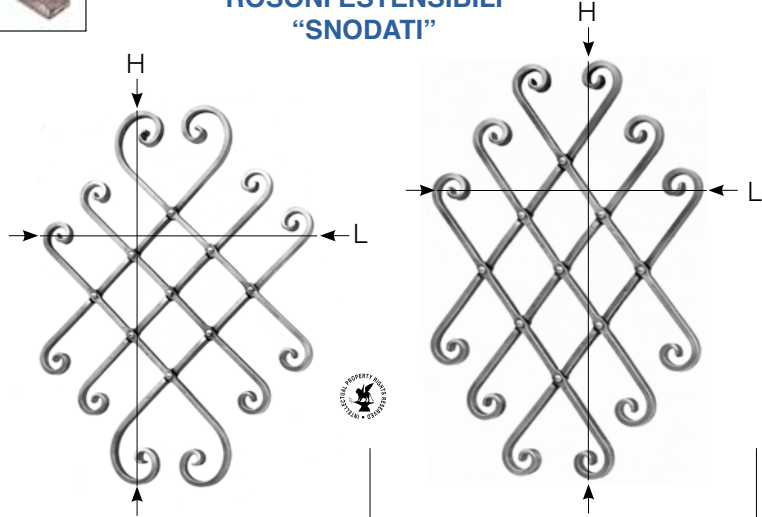

| | | |
|-----------------|---|---|
| Section-Sezione | from-da L. 440 x H. 580 mm to-a L. 380 x H. 620 mm | from-da L. 440 x H. 490 mm to-a L. 360 x H. 550 mm |
| | Art. | Art. |
| Ø 16 x 8 mm | * 1658/1 | * 1658/2 |

*articles not saleable in Spain
*articoli non vendibili in Spagna

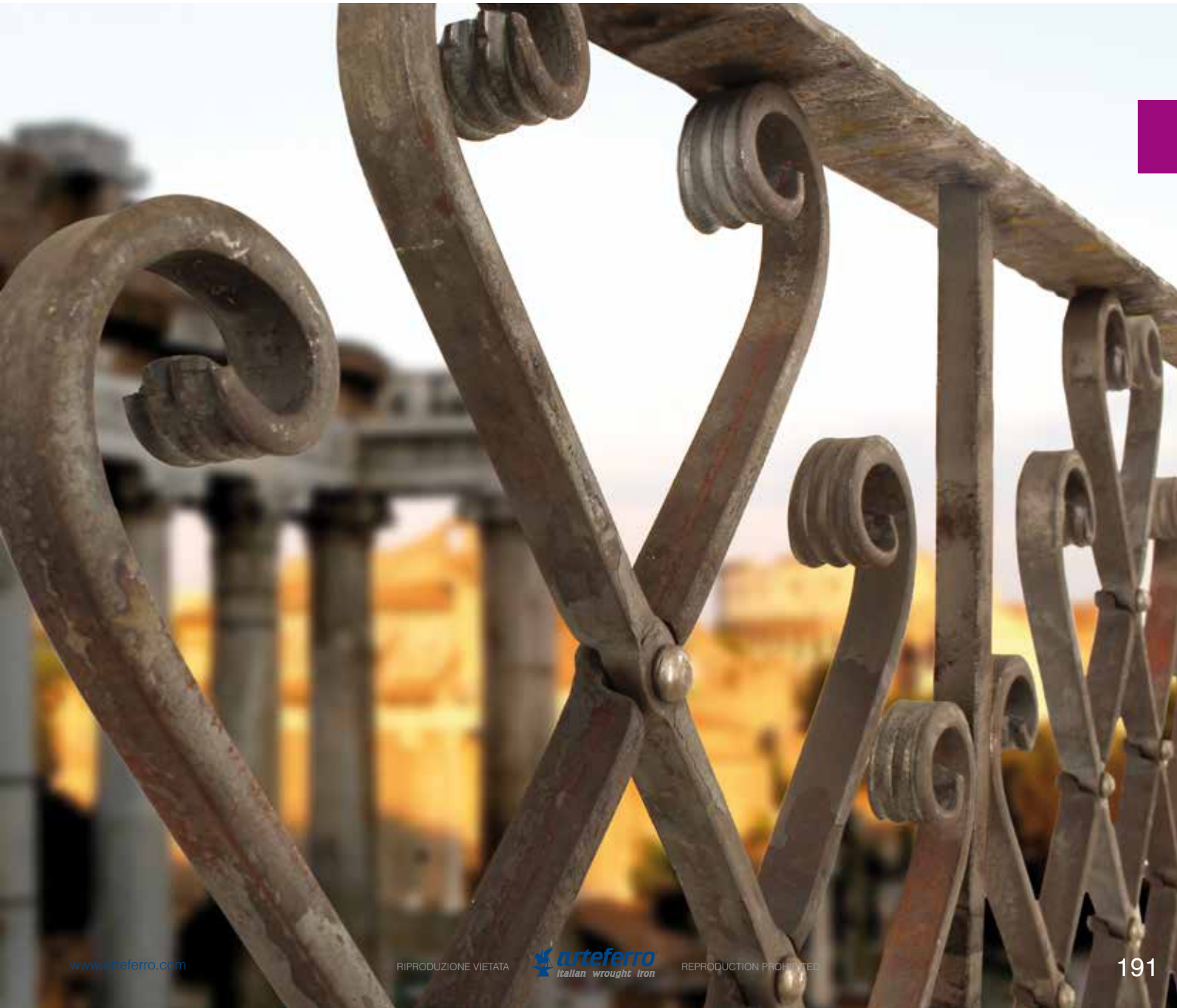



LOGISTIC SUPPORT ASSISTENZA LOGISTICA

With branches spread across the continents, we have the largest stock of articles in the branch worldwide, and, thanks to our agreements with major carriers, we can guarantee prompt deliveries in any country.

Con le nostre filiali sparse in tutti i continenti, disponiamo del più grande stock mondiale di articoli del settore e, grazie ai nostri accordi con i più importanti spedizionieri, possiamo garantire consegne celeri in qualsiasi paese.

+39 0445 580 580

from Monday to Friday
dal Lunedì al Venerdì
08.00 -18.00 (GMT+1)

info@arteferro.com

www.arteferro.com





RINGS

Arteferro circles, with their simple, discreet shape, are items that can complete any wrought iron composition. Since they can be used as decorations and joints, they even help to support items of great structural complexity. They are available with various types of section: rounded, half rounded, square with hot pressed ends and various types of finishes.

I cerchi Arteferro, con la loro forma semplice e discreta, sono elementi in grado di completare qualsiasi composizione in ferro battuto. Utilizzabili come decoro e congiunzione, aiutano a sostenere i manufatti anche di grande complessità strutturale. Sono disponibili in varie sezioni: tondo, mezzo tondo, quadre con estremità stampate a caldo e lavorazioni di vario tipo.

CERCHI



Arteferro products
can be manufactured
as well as customised.

I prodotti Arteferro
sono realizzabili
anche su misura.

PLAIN RINGS CERCHI LISCI



| Section Sezione | Ø 10 mm | Ø 12 mm | Ø 14 mm | Ø 16 mm | Φ 12 x 12 mm | Φ 14 x 14 mm | Φ 16 x 16 mm | Φ 18 x 18 mm | Φ 20 x 20 mm | Φ 25 x 25 mm | Φ 30 x 30 mm |
|--------------------|------------|------------|------------|------------|-----------------|-----------------|-----------------|-----------------|-----------------|-----------------|-----------------|
| | Art. | Art. | Art. | Art. | Art. | Art. | Art. | Art. | Art. | Art. | Art. |
| Ø 89 mm | - | - | - | - | 491/8/D89 | - | - | - | - | - | - |
| Ø 100 mm | 1317/6 | 1317/9 | 1803/4 | - | 491/8 | 491/16 | 491/17 | - | - | - | - |
| Ø 105 mm | - | 1317/28 | - | - | 1802/64 | 1802/65 | 1802/114 | - | - | - | - |
| Ø 110 mm | - | 1317/27 | 1803/7 | - | 1802/68 | 1802/69 | 1802/70 | - | - | - | - |
| Ø 115 mm | 1317/7 | 1317/10 | 1803/5 | - | 1317/1 | 1802/73 | 1802/74 | - | - | - | - |
| Ø 120 mm | 1317/24 | 1317/25 | - | - | 1802/77 | 1802/78 | 1802/79 | - | - | - | - |
| Ø 127 mm | - | - | - | - | 491/8/D127 | - | - | - | - | - | - |
| Ø 130 mm | 1317/8 | 1317/11 | 1803/6 | - | 1317/2 | 1802/82 | 1802/83 | 1802/84 | 1802/85 | - | - |
| Ø 133 mm | - | - | - | - | 491/8/D133 | - | - | - | - | - | - |
| Ø 135 mm | - | - | - | 1803/8 | - | - | 1802/115 | - | - | - | - |
| Ø 140 mm | - | - | - | - | 491/8/D140 | - | - | - | - | - | - |
| Ø 160 mm | - | - | - | - | 1802/88 | 1802/89 | 1802/90 | 1802/91 | 1802/92 | 1802/93 | - |
| Ø 180 mm | - | - | - | - | 1802/96 | 1802/97 | 1802/98 | 1802/99 | 1802/100 | 1802/101 | 1802/102 |
| Ø 190 mm | - | - | - | - | - | - | - | - | - | - | - |
| Ø 200 mm | - | - | - | - | 1802/105 | 1802/106 | 1802/107 | 1802/108 | 1802/109 | 1802/110 | 1802/111 |



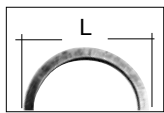

| Section Sezione | 12 x 6 mm | 14 x 6 mm | 14 x 8 mm | 16 x 4 mm | 16 x 6 mm | 16 x 8 mm | 20 x 4 mm | 20 x 6 mm | 20 x 8 mm | 25 x 4 mm | 30 x 8 mm | 40 x 8 mm |
|--------------------|--------------|--------------|--------------|--------------|--------------|--------------|--------------|--------------|--------------|--------------|--------------|--------------|
| | Art. | Art. | Art. | Art. | Art. | Art. | Art. | Art. | Art. | Art. | Art. | Art. |
| Ø 100 mm | 157/1 | 1320/7 | 1320/10 | 1320/1 | 1802/1 | 1802/2 | 157/6 | 1320/4 | 1802/3 | 157/11 | 1802/112 | 1802/113 |
| Ø 105 mm | 1802/4 | 1802/5 | 1802/6 | 1802/7 | 1802/8 | 1802/9 | 1802/10 | 1802/11 | 1802/12 | - | 1802/62 | 1802/63 |
| Ø 110 mm | 1802/13 | 1802/14 | 1802/15 | 1802/16 | 1802/17 | 1802/18 | 1802/19 | 1802/20 | 1802/21 | - | 1802/66 | 1802/67 |
| Ø 115 mm | 157/2 | 1320/8 | 1320/11 | 1320/2 | 1802/22 | 1802/23 | 157/7 | 1320/5 | 1802/24 | 157/12 | 1802/71 | 1802/72 |
| Ø 120 mm | 1802/25 | 1802/26 | 1802/27 | 1802/28 | 1802/29 | 1802/30 | 1802/31 | 1802/32 | 1802/33 | - | 1802/75 | 1802/76 |
| Ø 130 mm | 157/3 | 1320/9 | 1320/12 | 1320/3 | 1802/34 | 1802/35 | 157/8 | 1320/6 | 1802/36 | 157/13 | 1802/80 | 1802/81 |
| Ø 160 mm | 157/4 | 1802/37 | 1802/38 | 1802/39 | 1802/40 | 1802/41 | 157/9 | 1802/42 | 1802/43 | 157/14 | 1802/86 | 1802/87 |
| Ø 180 mm | 1802/44 | 1802/45 | 1802/46 | 1802/47 | 1802/48 | 1802/49 | 1802/50 | 1802/51 | 1802/52 | - | 1802/94 | 1802/95 |
| Ø 190 mm | 157/5 | - | - | - | - | - | 157/10 | - | - | 157/15 | - | - |
| Ø 200 mm | 1802/53 | 1802/54 | 1802/55 | 1802/56 | 1802/57 | 1802/58 | 1802/59 | 1802/60 | 1802/61 | - | 1802/103 | 1802/104 |

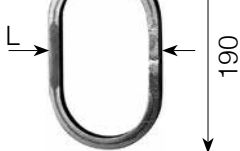

Section - Sezione
 \varnothing 12 x 12 mm

| | Art. | Art. | |
|----------------------------------|----------|---------|---------|
| plain liscio | L 100 mm | 491/8 | 1317/3 |
| | L 115 mm | 1317/1 | 1317/4 |
| | L 130 mm | 1317/2 | 1317/5 |
| Bark effect corteccia | L 100 mm | 1317/18 | 1317/21 |
| | L 115 mm | 1317/19 | 1317/22 |
| | L 130 mm | 1317/20 | 1317/23 |
| diamond diamantato | L 100 mm | 1318/1 | 1318/4 |
| | L 115 mm | 1318/2 | 1318/5 |
| | L 130 mm | 1318/3 | 1318/6 |
| hammered spigolato | L 100 mm | 491/9 | 1318/9 |
| | L 115 mm | 1318/7 | 1318/10 |
| | L 130 mm | 1318/8 | 1318/11 |
| rigato grooved | L 100 mm | 1318/12 | 1318/15 |
| | L 115 mm | 1318/13 | 1318/16 |
| | L 130 mm | 1318/14 | 1318/17 |
| four-leaf clover quadrifoglio | L 100 mm | - | - |
| | L 115 mm | 1319/2 | - |
| | L 130 mm | 1319/3 | 1319/6 |





OVAL RINGS - CERCHI OVALI

| H x L mm | \varnothing 10 mm | \varnothing 12 mm | \varnothing 12 x 12 mm | \varnothing 12 x 6 mm | \varnothing 14 x 6 mm | \varnothing 14 x 8 mm | \varnothing 16 x 4 mm | \varnothing 20 x 4 mm | \varnothing 20 x 6 mm |
|--------------|---------------------|---------------------|--------------------------|-------------------------|-------------------------|-------------------------|-------------------------|-------------------------|-------------------------|
| 190 x 100 mm | Art. 1317/12 | 1317/15 | 1317/3 | 1320/22 | 1320/19 | 1320/28 | 1320/13 | 1320/25 | 1320/16 |
| 190 x 115 mm | 1317/13 | 1317/16 | 1317/4 | 1320/23 | 1320/20 | 1320/29 | 1320/14 | 1320/26 | 1320/17 |
| 190 x 130 mm | 1317/14 | 1317/17 | 1317/5 | 1320/24 | 1320/21 | 1320/30 | 1320/15 | 1320/27 | 1320/18 |



plain - liscio
Art. 156/1
 \varnothing 12 x 12 mm
 117 x 165 mm



with 4 stamps
 con 4 stampe
Art. 156/2
 \varnothing 12 x 12 mm
 125 x 175 mm



with 8 stamps
 con 8 stampe
Art. 156/3
 \varnothing 12 x 12 mm
 130 x 170 mm



Art. 1321/9
 \varnothing 12 x 12 mm
 L 100 x 100 mm
Art. 1321/11
 \varnothing 14 x 14 mm
 L 100 x 100 mm



hammered
 spigolato
Art. 1803/1
 \varnothing 12 x 6 mm
 \varnothing 100 mm
Art. 1803/2
 \varnothing 12 x 6 mm
 \varnothing 115 mm
Art. 1803/3
 \varnothing 12 x 6 mm
 \varnothing 130 mm



plain
 liscio
 \varnothing 12 x 6 mm
Art. 1299/5
 \varnothing 100 mm
Art. 1299/6
 \varnothing 130 mm
 \varnothing 14 x 6 mm
Art. 1299/7
 \varnothing 100 mm
Art. 1299/8
 \varnothing 130 mm





Arteferro scrolls and snap-ons have been designed to embellish even the simplest wrought iron composition. Like the other Arteferro decorative elements, they can be used in many different projects, from gates to the railings, as well as on stairways and balconies. Even a fence or a balustrade with vertical posts made of plain iron can be embellished at a later time by these useful decorative items.

I ricci e gli snap-ons Arteferro sono stati ideati per impreziosire anche la più semplice composizione in ferro battuto. Come gli altri elementi decorativi Arteferro, trovano applicazione in molteplici realizzazioni, dalla cancellate alle inferriate, così come nelle scale e nelle balconate. Anche una recinzione o un parapetto in paletti verticali di ferro liscio può essere arricchita in un secondo momento con l'utilizzo di questi utili elementi decorativi.

RICCI E SNAP-ONS

SCROLLS AND SNAP-ONS

11

Scrolls and Snap-ons
Ricci e Snap-ons



11.A Scrolls pag.198
Ricci
11.B Snap-ons pag.215

This section will give you an overview of Arteferro scrolls. The main characteristic element of a scroll is the end. We have organised the items upon this, in accordance with their style or the manufacturing used. Once you've chosen the end, you can find your scroll.

Questo capitolo vi darà una panoramica dei ricci Arteferro. Principale elemento caratterizzante di un riccio è il terminale. Su questo abbiamo organizzato gli articoli, in base allo stile o alla lavorazione. Scelto il terminale, trovi il tuo riccio.

Cold cut ends
Terminali tranciati
a freddo



| | | | | | | |
|--------------------|------------------------------|------------------------------|------------------------------|------------------------------|-----------------------------|-----------------------------|
| Section Sezione | L 120 mm H 360 mm Art. | L 120 mm H 360 mm Art. | L 120 mm H 290 mm Art. | L 108 mm H 220 mm Art. | L 60 mm H 115 mm Art. | L 90 mm H 180 mm Art. |
| ∅ 8 x 8 mm | 74/6 | 74/12 | 74/18 | 74/24 | 78/6 | 78/12 |
| ∅ 10 x 5 mm | 74/1 | 74/7 | 74/13 | 74/19 | 78/1 | 78/7 |
| ∅ 12 x 6 mm | 74/2 | 74/8 | 74/14 | 74/20 | 78/2 | 78/8 |
| ∅ 14 x 6 mm | 74/25 | 74/27 | 74/26 | 74/28 | 78/14 | 78/13 |
| ∅ 16 x 4 mm | 74/3 | 74/9 | 74/15 | 74/21 | 78/3 | 78/9 |
| ∅ 20 x 4 mm | 74/4 | 74/10 | 74/16 | 74/22 | 78/4 | 78/10 |
| ∅ 20 x 6 mm | 74/5 | 74/11 | 74/17 | 74/23 | 78/5 | 78/11 |

Hot forged cut ends
Terminali fucinati
a caldo e tranciati



| | | | | | | |
|--------------------|-----------------------------|-----------------------------|-----------------------------|-----------------------------|-----------------------------|-----------------------------|
| Section Sezione | L 75 mm H 120 mm Art. | L 75 mm H 160 mm Art. | L 75 mm H 130 mm Art. | L 75 mm H 150 mm Art. | L 65 mm H 150 mm Art. | L 70 mm H 190 mm Art. |
| ∅ 12 x 6 mm | 80/B/8 | 88/H/4 | 88/H/3 | 88/H/2 | 80/A/11 | 80/A/12 |
| ∅ 14 x 6 mm | - | - | - | - | 80/A/26 | 80/A/27 |
| ∅ 16 x 4 mm | 80/B/3 | - | - | - | 80/A/19 | 80/A/20 |

Hot forged cut ends
Terminali fucinati
a caldo e tranciati



| | | | | |
|--------------------|-----------------------------|-----------------------------|-----------------------------|-----------------------------|
| Section Sezione | L 68 mm H 110 mm Art. | L 70 mm H 105 mm Art. | L 70 mm H 100 mm Art. | L 95 mm H 140 mm Art. |
| ∅ 12 x 6 mm | 80/A/31 | 80/A/9 | 80/A/32 | 80/A/10 |
| ∅ 14 x 6 mm | - | 80/A/24 | - | 80/A/25 |
| ∅ 16 x 4 mm | - | 80/A/17 | - | 80/A/18 |

Plain-Liscio
1368/2

∅ 8 x 8 mm

Plain-Liscio
1368/11

∅ 10 x 5 mm

∅ 12 x 6 mm

∅ 12 x 6 mm

1368/41

∅ 14 x 6 mm

1368/14

∅ 16 x 4 mm

1368/15

∅ 20 x 4 mm

1368/16

∅ 20 x 6 mm

Plain-Liscio
1368/12

∅ 12 x 6 mm

1368/41

∅ 14 x 6 mm

1368/14

∅ 16 x 4 mm

Plain-Liscio
1368/12

∅ 12 x 6 mm

1368/41

∅ 14 x 6 mm

1368/14

∅ 16 x 4 mm

Hot forged ends
Terminali fucinati
a caldo



| Section Sezione | L 65 mm H 95 mm Art. | L 70 mm H 110 mm Art. | L 60 mm H 120 mm Art. | L 80 mm H 130 mm Art. | L 80 mm H 145 mm Art. | L 80 mm H 190 mm Art. | L 100 mm H 260 mm Art. |
|--------------------|----------------------------|-----------------------------|-----------------------------|-----------------------------|-----------------------------|-----------------------------|------------------------------|
| ∅ 12 x 6 mm | 80/C/8 | 80/C/7 | 80/C/9 | 80/C/10 | 80/C/11 | 80/C/14 | 80/C/13 |
| ∅ 14 x 6 mm | 80/C/18 | 80/C/17 | 80/C/19 | 80/C/20 | 80/C/21 | 80/C/24 | 80/C/23 |

Plain
Liscio

1368/12

∅ 12 x 6 mm

1368/41

∅ 14 x 6 mm

Hot forged cut ends
Terminali fucinati
a caldo e tranciati



| Section Sezione | L 110 mm H 270 mm Art. | L 100 mm H 270 mm Art. | L 110 mm H 280 mm Art. | L 100 mm H 270 mm Art. |
|--------------------|------------------------------|------------------------------|------------------------------|------------------------------|
| ∅ 12 x 6 mm | 80/A/1 | 80/A/2 | 80/A/5 | 80/A/4 |
| ∅ 14 x 6 mm | 80/A/28 | - | 80/A/1/S8 | - |
| ∅ 16 x 4 mm | 80/A/21 | - | - | - |
| ∅ 16 x 6 mm | 80/A/14 | - | - | - |

Plain
Liscio

1368/12

∅ 12 x 6 mm

1368/41

∅ 14 x 6 mm

1368/14

∅ 16 x 4 mm

1368/43

∅ 16 x 6 mm

Hot forged cut ends
Terminali fucinati
a caldo e tranciati



| Section Sezione | L 60 mm H 100 mm Art. | L 60 mm H 110 mm Art. | L 60 mm H 115 mm Art. | L 75 mm H 125 mm Art. | L 110 mm H 150 mm Art. |
|--------------------|-----------------------------|-----------------------------|-----------------------------|-----------------------------|------------------------------|
| ∅ 12 x 6 mm | 80/A/6 | 80/A/3 | 80/A/7 | 80/A/8 | 80/A/13 |
| ∅ 14 x 6 mm | - | 80/A/29 | - | - | 80/A/30 |
| ∅ 16 x 4 mm | - | 80/A/22 | - | - | 80/A/23 |
| ∅ 16 x 6 mm | - | 80/A/15 | - | - | 80/A/16 |

Plain
Liscio

1368/12

∅ 12 x 6 mm

1368/41

∅ 14 x 6 mm

1368/14

∅ 16 x 4 mm

1368/43

∅ 16 x 6 mm





Plain-Liscio
1368/4
Φ 12 x 12 mm
1368/5
Φ 14 x 14 mm



Hammered Spigolato
118/1
Φ 12 x 12 mm
118/2
Φ 14 x 14 mm



Plain-Liscio
1368/4
Φ 12 x 12 mm



Hammered Spigolato
118/1
Φ 12 x 12 mm

Hot forged scroll
Venetian style
Riccio fucinato
a caldo "veneziana"



| Section Sezione | L 90 mm H 145 mm Art. | L 95 mm H 150 mm Art. | L 105 mm H 220 mm Art. | L 105 mm H 220 mm Art. | L 105 mm H 300 mm Art. |
|--------------------|-----------------------------|-----------------------------|------------------------------|------------------------------|------------------------------|
| Φ 12 x 12 mm | - | 94/Q/5 | 94/P/1 | 94/Q/1 | 94/P/9 |
| Φ 14 x 14 mm | 88/I/3 | 94/Q/6 | 94/P/2 | 94/Q/2 | 94/P/10 |

| | | | | | |
|--------------|--------|--------|--------|--------|---------|
| Φ 12 x 12 mm | 94/Q/3 | 94/Q/7 | 94/P/3 | 94/Q/3 | 94/P/11 |
| Φ 14 x 14 mm | 88/I/2 | 94/Q/8 | 94/P/4 | 94/Q/4 | 94/P/12 |

Hot forged scroll
Venetian style
Riccio fucinato
a caldo "veneziana"



| Section Sezione | L 65 mm H 105 mm Art. | L 110 mm H 160 mm Art. | L 185 mm H 160 mm Art. | L 180 mm H 445 mm Art. | L 240 mm H 455 mm Art. |
|--------------------|-----------------------------|------------------------------|------------------------------|------------------------------|------------------------------|
| Φ 12 x 12 mm | 1046/7 | 1046/6 | 1046/4 | 1046/5 | 1046/3 |

Hot forged ends
Terminali fucinati
a caldo



| Section Sezione | L 190 mm H 385 mm Art. | L 80 mm H 560 mm Art. |
|--------------------|------------------------------|-----------------------------|
| Φ 12 x 12 mm | 88/L/3 | 88/L/4 |



Hot forged ends
Baroque style
Terminali fucinati
a caldo "barocco"



| | | | | | | | |
|--------------------|------------------------------|------------------------------|------------------------------|------------------------------|------------------------------|-----------------------------|-----------------------------|
| Section Sezione | L 120 mm H 360 mm Art. | L 120 mm H 360 mm Art. | L 120 mm H 290 mm Art. | L 120 mm H 220 mm Art. | L 115 mm H 255 mm Art. | L 90 mm H 180 mm Art. | L 60 mm H 115 mm Art. |
| Ø 12 mm | 1295/1 | 1295/2 | 1295/3 | 1295/4 | 1295/5 | 1295/6 | 1295/7 |

Plain-Liscio

1368/9
Ø 12 mm

Hot forged ends
Baroque style
Terminali fucinati
a caldo "barocco"



| | | | | | |
|--------------------|------------------------------|-----------------------------|------------------------------|-----------------------------|-----------------------------|
| Section Sezione | L 120 mm H 260 mm Art. | L 95 mm H 260 mm Art. | L 100 mm H 260 mm Art. | L 90 mm H 135 mm Art. | L 70 mm H 110 mm Art. |
| Ø 12 mm | 1296/9 | 1296/10 | 1296/11 | 1296/12 | 1296/13 |

Hammered
Battuto

600/4
Ø 12 mm

Hot forged ends
Baroque style
Terminali fucinati
a caldo "barocco"



| | | | | |
|--------------------|-----------------------------|-----------------------------|-----------------------------|-----------------------------|
| Section Sezione | L 60 mm H 115 mm Art. | L 70 mm H 115 mm Art. | L 90 mm H 140 mm Art. | L 90 mm H 180 mm Art. |
| Ø 12 x 6 mm | 1296/6 | 1296/8 | 1296/7 | 1296/5 |

Diamond
Diamantato

623/1
Ø 12 x 6 mm

Hot forged ends
Baroque style
Terminali fucinati
a caldo "barocco"



| | | | | |
|--------------------|------------------------------|------------------------------|------------------------------|------------------------------|
| Section Sezione | L 120 mm H 220 mm Art. | L 120 mm H 290 mm Art. | L 120 mm H 360 mm Art. | L 120 mm H 360 mm Art. |
| Ø 12 x 6 mm | 1296/4 | 1296/3 | 1296/2 | 1296/1 |

Diamond
Diamantato

623/1
Ø 12 x 6 mm

Hot forged ends
"baroque cut"
Terminali fucinati
a caldo
"barocco rifilato"

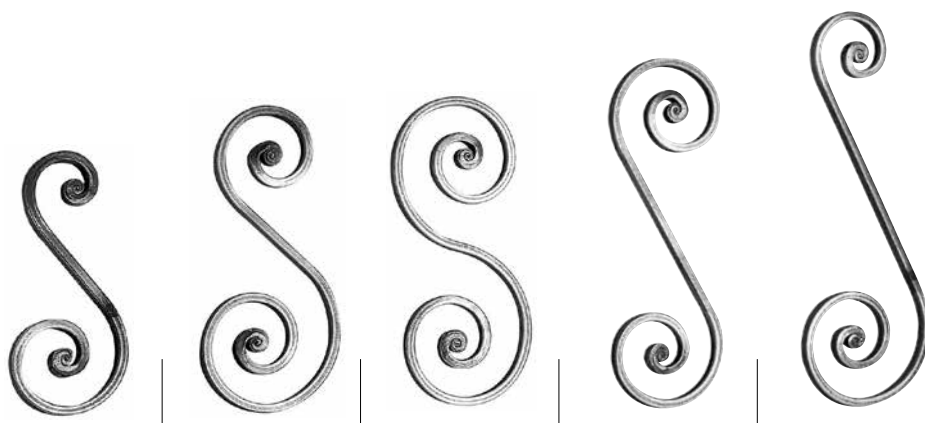

| | | | | | |
|--------------------|------------------------------|------------------------------|------------------------------|------------------------------|------------------------------|
| Section Sezione | L 100 mm H 220 mm Art. | L 120 mm H 280 mm Art. | L 120 mm H 280 mm Art. | L 120 mm H 330 mm Art. | L 120 mm H 390 mm Art. |
| ∅ 14 x 8 mm | 1301/5 | 1301/4 | 1301/3 | 1301/2 | 1301/1 |

Plain-Liscio
1368/13
∅ 14 x 8 mm

Hot forged ends
"baroque cut"
Terminali fucinati
a caldo
"barocco rifilato"



| | | | | | |
|--------------------|-----------------------------|------------------------------|------------------------------|------------------------------|------------------------------|
| Section Sezione | L 70 mm H 130 mm Art. | L 100 mm H 160 mm Art. | L 100 mm H 210 mm Art. | L 120 mm H 260 mm Art. | L 120 mm H 325 mm Art. |
| ∅ 14 x 8 mm | 1301/10 | 1301/8 | 1301/9 | 1301/7 | 1301/6 |

Plain-Liscio
1368/13
∅ 14 x 8 mm



Hot forged ends
Terminali fucinati
a caldo



Plain-Liscio

- 1368/4
- Ø 12 x 12 mm
- 1368/5
- Ø 14 x 14 mm
- 1368/13
- Ø 14 x 8 mm

| Section Sezione | L 80 mm H 130 mm Art. | L 80 mm H 160 mm Art. | L 130 mm H 290 mm Art. | L 110 mm H 220 mm Art. | L 110 mm H 220 mm Art. | L 110 mm H 300 mm Art. |
|--------------------|-----------------------------|-----------------------------|------------------------------|------------------------------|------------------------------|------------------------------|
| Ø 12 x 12 mm | - | - | - | 78/B/1 | 78/B/2 | 78/B/3 |
| Ø 14 x 14 mm | - | - | - | 78/B/4 | 78/B/5 | 78/B/6 |
| Ø 14 x 8 mm | 88/P/3 | 88/P/2 | 88/P/1 | - | - | - |

Cold stamped scrolls
Ricci stampati
a freddo



Plain-Liscio

- 1368/12
- Ø 12 x 6 mm

| Section Sezione | L 70 mm H 110 mm Art. | L 73 mm H 123 mm Art. | L 80 mm H 130 mm Art. | L 80 mm H 150 mm Art. | L 90 mm H 160 mm Art. | L 95 mm H 210 mm Art. |
|--------------------|-----------------------------|-----------------------------|-----------------------------|-----------------------------|-----------------------------|-----------------------------|
| Ø 12 x 6 mm | 88/A/3 | 88/10 | 87/1 | 87/6 | 87/5 | 86/5 |



i Arteferro products can be manufactured as well as customised.
I prodotti Arteferro sono realizzabili anche su misura.

Scrolls - Ricci

Cold cut ends
Terminali tranciati
a freddo



| | | | | | | |
|--------------------|-----------------------------|-----------------------------|------------------------------|------------------------------|------------------------------|------------------------------|
| Section Sezione | L 60 mm H 115 mm Art. | L 90 mm H 180 mm Art. | L 120 mm H 220 mm Art. | L 120 mm H 290 mm Art. | L 120 mm H 360 mm Art. | L 120 mm H 360 mm Art. |
| ∅ 12 x 6 mm | 641/3 | 641/4 | 641/5 | 641/6 | 641/7 | 641/8 |

Diamond
Diamantato
623/1
∅ 12 x 6 mm

Hot forged
scrolls
Ricci fucinati
a caldo



| | | |
|--------------------|-----------------------------|-----------------------------|
| Section Sezione | L 70 mm H 105 mm Art. | L 70 mm H 130 mm Art. |
| ∅ 12 x 6 mm | 641/1 | 641/2 |

Diamond
Diamantato
623/1
∅ 12 x 6 mm

Hot forged ends
Terminali fucinati
a caldo



| | | | |
|--------------------|-----------------------------|------------------------------|------------------------------|
| Section Sezione | L 60 mm H 120 mm Art. | L 120 mm H 290 mm Art. | L 120 mm H 360 mm Art. |
| ∅ 10 mm | 1297/7 | 1297/3 | 1297/2 |



Notched
Tacchettato
622/1

∅ 12 x 6 mm



Hot forged ends
Terminali fucinati a caldo



Art. 64/G/3
∅ 12 x 6 mm
105 x 150 mm

Art. 64/G/6
∅ 12 x 6 mm
50 x 230 mm

Art. 64/G/4
∅ 12 x 6 mm
60 x 105 mm

Art. 64/G/5
∅ 12 x 6 mm
60 x 105 mm

Scrolls - Ricci

Ends with sphere
Terminali con pallina



| | | |
|--------------------|------------------------------|------------------------------|
| Section Sezione | L 150 mm H 350 mm Art. | L 150 mm H 350 mm Art. |
| ∅ 12 x 12 mm | 1308/12 | - |
| ∅ 14 x 14 mm | 1308/13 | |
| ∅ 12 mm | - | |
| ∅ 14 mm | - | 1308/8 |
| ∅ 16 mm | - | 1308/9 |

Hot forged ends
Terminali fucinati a caldo

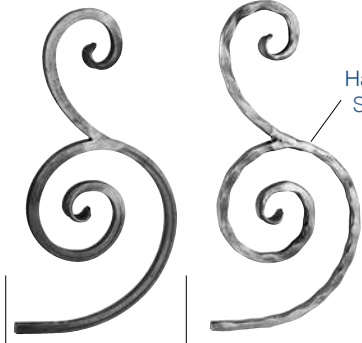

Hammered
Spigolato

| | | |
|--------------------|------------------------------|------------------------------|
| Section Sezione | L 180 mm H 360 mm Art. | L 180 mm H 360 mm Art. |
| ∅ 12 x 12 mm | 1308/1 | 1308/3 |
| ∅ 14 x 14 mm | 1308/2 | 1308/4 |
| ∅ 12 mm | - | - |
| ∅ 14 mm | 1308/11 | - |
| ∅ 16 mm | 1308/7 | - |

Hot forged ends
Terminali fucinati a caldo



| | | |
|--------------------|-----------------------------|-----------------------------|
| Section Sezione | L 65 mm H 130 mm Art. | L 80 mm H 130 mm Art. |
| ∅ 12 x 12 mm | 658/8 | 658/7 |
| ∅ 12 mm | 659/11 | 659/10 |

Hot forged end
Terminale fucinato a caldo



Notched
Tacchettato
622/1
∅ 12 x 6 mm

| | | |
|--------------------|-----------------------------|------------------------------|
| Section Sezione | L 60 mm H 110 mm Art. | L 110 mm H 270 mm Art. |
| ∅ 12 x 6 mm | 88/N/6 | 88/N/3 |

Hot forged scroll
Riccio battuti a caldo



NEW

Art. 78/15
∅ 30 x 8 mm
60 x 130 mm

Hot forged scroll
Venetian style
Riccio fucinato a caldo "veneziana"



NEW

Art. 78/16
∅ 30 x 8 mm
60 x 130 mm





Notched - Tacchettato

622/1
Ø 12 x 6 mm

Cold cut ends
Terminali tranciati
a freddo



| | | | | | |
|--------------------|----------------------------|-----------------------------|-----------------------------|------------------------------|------------------------------|
| Section Sezione | L 50 mm H 75 mm Art. | L 60 mm H 115 mm Art. | L 90 mm H 180 mm Art. | L 120 mm H 290 mm Art. | L 120 mm H 360 mm Art. |
| Ø 10 x 5 mm | 88/N/7 | - | - | - | - |
| Ø 12 x 6 mm | - | 88/N/5 | 88/N/4 | 88/N/2 | 88/N/1 |



Plain - Liscio

1368/7
Ø 8 mm
1368/78
Ø 10 mm



*Notched - Tacchettato

622/2
Ø 8 x 8 mm

Cold stamped scrolls
Ricci stampati
a freddo



| | | | | |
|--------------------|-----------------------------|-----------------------------|-----------------------------|-----------------------------|
| Section Sezione | L 85 mm H 115 mm Art. | L 73 mm H 122 mm Art. | L 73 mm H 122 mm Art. | L 73 mm H 122 mm Art. |
| Ø 8 x 8 mm | 81/1 | * 81/3 | * 81/5 | * 81/7 |
| Ø 8 mm | - | - | - | 82/3 |
| Ø 10 mm | - | - | - | 82/5 |



Plain - Liscio

1368/16
Ø 20 x 6 mm

Cold cut ends
Terminali tranciati
a freddo

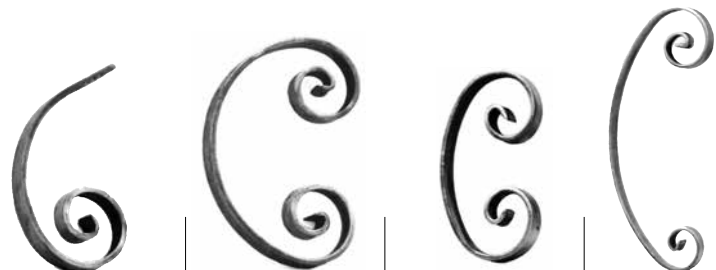

| | | | | |
|--------------------|-----------------------------|------------------------------|-----------------------------|------------------------------|
| Section Sezione | L 95 mm H 190 mm Art. | L 150 mm H 225 mm Art. | L 70 mm H 140 mm Art. | L 120 mm H 300 mm Art. |
| Ø 16 x 4 mm | - | - | 84/6 | 84/5 |
| Ø 20 x 6 mm | 84/8 | 84/7 | - | - |



Plain - Liscio

1368/14
Ø 16 x 4 mm

Cold cut ends
Terminali tranciati
a freddo



| | | | | |
|--------------------|-----------------------------|-----------------------------|------------------------------|------------------------------|
| Section Sezione | L 75 mm H 120 mm Art. | L 90 mm H 240 mm Art. | L 125 mm H 270 mm Art. | L 120 mm H 305 mm Art. |
| Ø 16 x 4 mm | 87/3 | 84/2 | 87/4 | 84/1 |

Cold stamped scrolls
Ricci stampati
a freddo



| | | | | |
|--------------------|------------------------------|------------------------------|------------------------------|------------------------------|
| Section Sezione | L 270 mm H 130 mm Art. | L 100 mm H 180 mm Art. | L 150 mm H 210 mm Art. | L 130 mm H 270 mm Art. |
| Ø 10 mm | 642/3 | 1290/3 | 1291/3 | 1291/5 |

Plain - Liscio

1368/8
Ø 10 mm

Cold stamped scrolls
Ricci stampati
a freddo



| | | | | |
|--------------------|------------------------------|------------------------------|------------------------------|------------------------------|
| Section Sezione | L 110 mm H 230 mm Art. | L 110 mm H 300 mm Art. | L 400 mm H 180 mm Art. | L 210 mm H 280 mm Art. |
| Ø 10 mm | 1290/2 | 1290/1 | 642/4 | 1291/4 |

Plain - Liscio

1368/8
Ø 10 mm

i Arterferro products can be manufactured as well as customised.
I prodotti Arterferro sono realizzabili anche su misura.

Cold stamped scrolls
Ricci stampati
a freddo

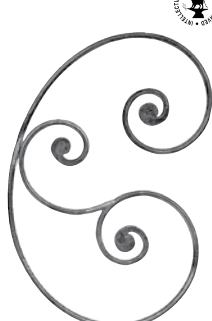
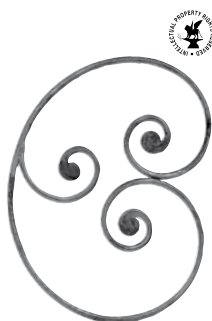

| | | | | |
|--------------------|------------------------------|------------------------------|------------------------------|------------------------------|
| Section Sezione | L 300 mm H 400 mm Art. | L 315 mm H 475 mm Art. | L 130 mm H 900 mm Art. | L 220 mm H 900 mm Art. |
| Ø 10 mm | 1291/2 | 1291/1 | 642/1 | 642/2 |

Plain - Liscio

1368/8
Ø 10 mm



Cold stamped scrolls
Ricci stampati a freddo



Plain - Liscio
1368/2
Ø 8 x 8 mm



Art. 73/1
Ø 8 x 8 mm
110 x 300 mm



Art. 73/2
Ø 8 x 8 mm
110 x 230 mm



Art. 73/3
Ø 8 x 8 mm
80 x 180 mm

Hot forged ends
Baroque style
Terminali fucinati
a caldo "barocco"



| | | | | | | |
|--------------------|-----------------------------|------------------------------|------------------------------|------------------------------|------------------------------|------------------------------|
| Section Sezione | L 70 mm H 120 mm Art. | L 100 mm H 160 mm Art. | L 200 mm H 300 mm Art. | L 200 mm H 320 mm Art. | L 200 mm H 320 mm Art. | L 110 mm H 690 mm Art. |
| Ø 16 x 8 mm | 655/1 | 655/2 | 655/3 | 655/4 | 655/5 | 656/1 |

Hammered
4 edges
Spigolato
4 spigoli
1839/24
Ø 16 x 8 mm



Plain - Liscio

- 1368/12
- Ø 12 x 6 mm
- 1368/14
- Ø 16 x 4 mm
- 1368/15
- Ø 20 x 4 mm

Cold cut ends
Terminali tranciati
a freddo



| | | | |
|--------------------|-----------------------------|-----------------------------|------------------------------|
| Section Sezione | L 90 mm H 130 mm Art. | L 80 mm H 320 mm Art. | L 100 mm H 320 mm Art. |
| Ø 12 x 6 mm | 88/4 | 88/1 | 76/1 |
| Ø 16 x 4 mm | 88/5 | 88/2 | 76/2 |
| Ø 20 x 4 mm | 88/6 | 88/3 | 76/3 |

i Arterferro products can be manufactured as well as customised.
I prodotti Arterferro sono realizzabili anche su misura.

Hot forged ends
Terminali fucinati
a caldo



| | | | | |
|---------|-----------------------------|------------------------------|-----------------------------|------------------------------|
| Sezione | L 90 mm H 180 mm Art. | L 120 mm H 220 mm Art. | L 80 mm H 245 mm Art. | L 120 mm H 290 mm Art. |
| Ø 8 mm | 646/4 | 646/5 | 646/3 | 646/8 |

Hammered
Battuto
Art. 600/2
Ø 8 mm

Hot forged ends
Terminali fucinati
a caldo



| | | | | |
|---------|------------------------------|------------------------------|------------------------------|------------------------------|
| Sezione | L 120 mm H 360 mm Art. | L 120 mm H 360 mm Art. | L 100 mm H 900 mm Art. | L 250 mm H 900 mm Art. |
| Ø 8 mm | 646/6 | 646/7 | - | - |
| Ø 12 mm | - | - | 646/1 | 646/2 |

Hammered
Battuto
Art. 600/2
Ø 12 mm
Art. 600/4
Ø 12 mm

Cold cut ends
Terminali tranciati
a freddo



| | |
|-------------|------------------------------|
| Sezione | L 125 mm H 350 mm Art. |
| Ø 10 x 5 mm | 75/31 |
| Ø 12 x 6 mm | 75/32 |
| Ø 8 x 8 mm | 75/33 |

Plain
Liscio
1368/2
Ø 8 x 8 mm
1368/11
Ø 10 x 5 mm
1368/12
Ø 12 x 6 mm



Scrolls - Ricci

Hot forged scroll
Venetian style
Riccio fucinato
a caldo "veneziana"



Plain - Liscio
1368/22
20 x 20 mm

| | | | | | | |
|--------------------|------------------------------|-----------------------------|------------------------------|------------------------------|------------------------------|-----------------------------|
| Section Sezione | L 100 mm H 120 mm Art. | L 80 mm H 130 mm Art. | L 120 mm H 190 mm Art. | L 115 mm H 260 mm Art. | L 125 mm H 310 mm Art. | L 80 mm H 320 mm Art. |
| 20 x 10 mm | 630/5 | 630/6 | 630/4 | 630/3 | 630/9 | - |
| 40 x 10 mm | - | - | - | - | - | 630/2 |

Plain - Liscio

1368/49
20 x 10 mm
1368/73
40 x 10 mm

Hot forged scroll
Venetian style
Riccio fucinato
a caldo "veneziana"



| | | | | | | | |
|--------------------|------------------------------|------------------------------|------------------------------|------------------------------|------------------------------|------------------------------|------------------------------|
| Section Sezione | L 125 mm H 330 mm Art. | L 112 mm H 339 mm Art. | L 205 mm H 360 mm Art. | L 210 mm H 400 mm Art. | L 200 mm H 470 mm Art. | L 240 mm H 470 mm Art. | L 190 mm H 580 mm Art. |
| 20 x 10 mm | - | 630/1 | - | 630/7 | 630/10 | - | 630/13 |
| 40 x 10 mm | 630/12 | - | 630/11 | - | - | - | - |
| 20 x 20 mm | - | - | - | - | - | 630/8 | - |

Plain - Liscio

1368/13
14 x 8 mm

Hot forged ends
"baroque cut"
Terminali fucinati
a caldo
"barocco rifilato"

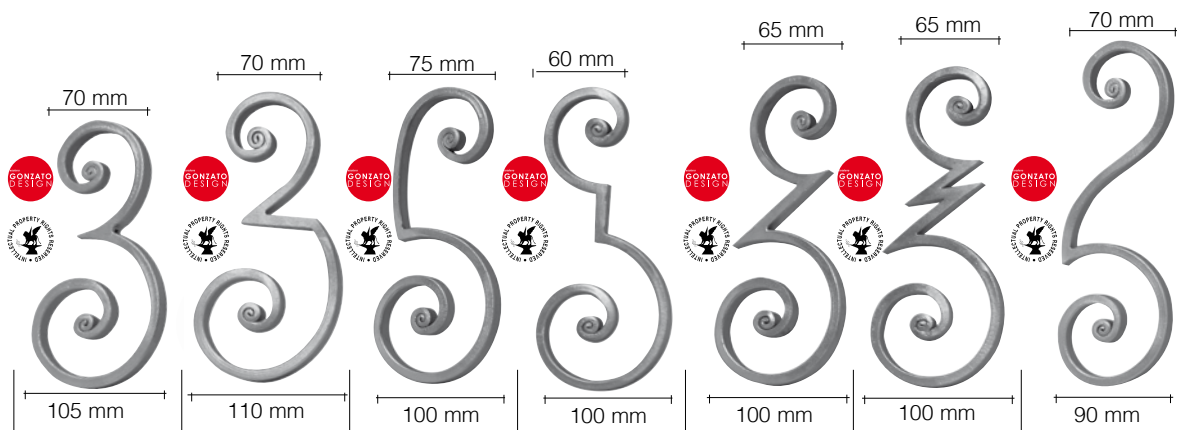

| | | | | | | | |
|-----------|------------------------------|------------------------------|------------------------------|------------------------------|------------------------------|------------------------------|-----------------------------|
| Sezione | L 105 mm H 200 mm Art. | L 110 mm H 215 mm Art. | L 100 mm H 220 mm Art. | L 100 mm H 220 mm Art. | L 100 mm H 230 mm Art. | L 100 mm H 237 mm Art. | L 95 mm H 270 mm Art. |
| 14 x 8 mm | GD262/1 | GD262/2 | GD263/2 | GD263/3 | GD262/3 | GD262/4 | GD263/1 |

Hot forged cut ends
Terminali fucinati
a caldo rifilati



NEW



NEW



NEW



NEW



NEW



Plain - Liscio

1368/12

12 x 6 mm

1368/43

16 x 6 mm

| Section Sezione | L 60 mm H 100 mm Art. | L 75 mm H 125 mm Art. | L 70 mm H 190 mm Art. | L 125 mm H 260 mm Art. | L 130 mm H 260 mm Art. | L 130 mm H 350 mm Art. |
|--------------------|-----------------------------|-----------------------------|-----------------------------|------------------------------|------------------------------|------------------------------|
| 16 x 6 mm | 1294/10 | 1294/11 | 1294/12 | 1294/13 | 1294/14 | 1294/15 |
| 12 x 6 mm | 1294/16 | 1294/17 | 1294/18 | 1294/19 | - | 1294/20 |



Pag.
112

In chapter 4
you'll find the
composite panels

Nel capitolo 4
troverai i pannelli
composti





Not all of the Arterferro items are available in **Arterferro Quick**, just a special selection. Find out about the entire range in the catalogue

In **Arterferro Quick** non sono presenti tutti gli articoli Arterferro, ma solo una speciale selezione. Scopri la gamma completa nel catalogo

Compendium

Hot forged plain ends
Terminali fucinati a caldo lisci



Hot forged plain ends
Terminali fucinati a caldo lisci



| | | | | |
|--------------------|------------------------------|------------------------------|------------------------------|------------------------------|
| | | | | |
| Section Sezione | L 180 mm H 180 mm Art. | L 190 mm H 190 mm Art. | L 210 mm H 210 mm Art. | L 210 mm H 210 mm Art. |
| Φ 14 x 14 mm | 1665/10 | * 1665/8 | 1665/14 | * 1665/12 |
| Φ 16 x 16 mm | 1665/11 | * 1665/9 | 1665/15 | * 1665/13 |

* articles not saleable in Spain

* articoli non vendibili in Spagna

Plain - Liscio

1368/5

Φ 14 x 14 mm

1368/20

Φ 16 x 16 mm

Hot forged ends
Venetian style
Terminali fucinati a caldo con veneziana



Hot forged ends
Venetian style
Terminali fucinati a caldo con veneziana



Hot forged plain ends
Terminali fucinati a caldo lisci



| | | | | | | | | |
|--------------------|-----------------------------|------------------------------|------------------------------|------------------------------|------------------------------|------------------------------|------------------------------|------------------------------|
| | | | | | | | | |
| Section Sezione | L 85 mm H 110 mm Art. | L 100 mm H 340 mm Art. | L 100 mm H 340 mm Art. | L 200 mm H 340 mm Art. | L 200 mm H 390 mm Art. | L 180 mm H 380 mm Art. | L 180 mm H 380 mm Art. | L 180 mm H 380 mm Art. |
| Φ 14 x 14 mm | 1665/1 | 1665/2 | 1665/3 | 1665/18 | * 1665/16 | 1665/6 | 1665/4 | 1665/5 |
| Φ 16 x 16 mm | - | - | - | - | * 1665/17 | 1665/7 | 1665/5 | 1665/5 |

* articles not saleable in Spain

* articoli non vendibili in Spagna



Art. 94/1
 ∅ 12 x 6 mm
 200 x 300 mm



Art. 94/2
 ∅ 12 x 6 mm
 150 x 200 mm



Art. 94/3
 ∅ 12 x 6 mm
 150 x 200 mm

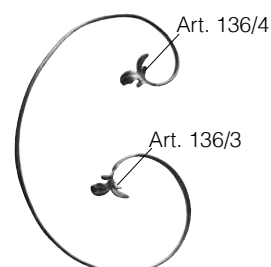

Art. 93/1
 ∅ 12 x 6 mm
 320 x 450 mm

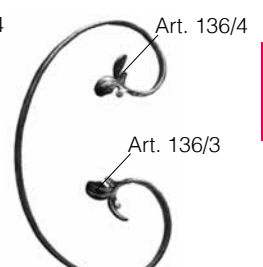

Art. 93/2
 ∅ 12 x 6 mm
 200 x 300 mm

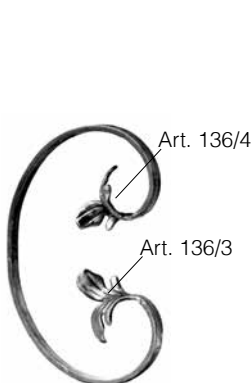

Art. 92/B/4
 ∅ 12 x 6 mm
 160 x 250 mm



Art. 93/4
 ∅ 12 x 6 mm
 230 x 350 mm



Art. 92/B/3
 ∅ 12 x 6 mm
 80 x 350 mm



Art. 92/C/3
 ∅ 12 x 6 mm
 95 x 380 mm



Art. 93/3
 ∅ 12 x 6 mm
 200 x 450 mm

Arteferro scrolls from the 94 line adorn the balconies of the Chechen government headquarters in Grozny. I ricci Arteferro della linea 94 ornano i parapetti della sede del governo ceceno a Grozny.



Art. 94/C/2
16 x 2,5 mm
140 x 170 mm



Art. 94/C/1
16 x 2,5 mm
78 x 140 mm

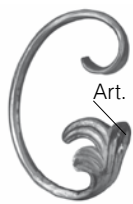

Art. 94/C/4
Ø 10 mm
110 x 170 mm



Art. 94/C/3
Ø 10 mm
110 x 170 mm



Art. 94/C/6
Ø 10 mm
190 x 270 mm

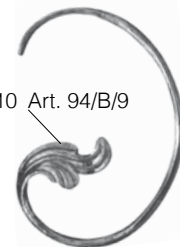

Art. 94/C/5
Ø 10 mm
190 x 270 mm

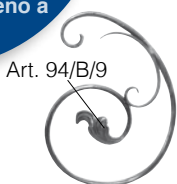

right - destro
Art. 94/C/9
Ø 12 mm
280 x 390 mm



left - sinistro
Art. 94/C/10
Ø 12 mm
280 x 390 mm

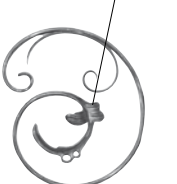

right - destro
Art. 94/C/11
Ø 12 mm
330 x 370 mm

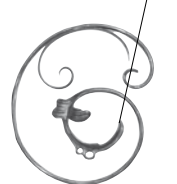

left - sinistro
Art. 94/C/12
Ø 12 mm
330 x 370 mm

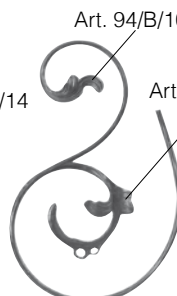

right - destro
Art. 94/C/13
Ø 12 mm
330 x 510 mm

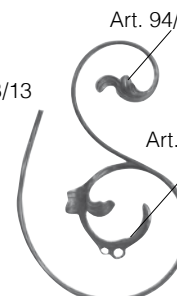

left - sinistro
Art. 94/C/14
Ø 12 mm
330 x 510 mm

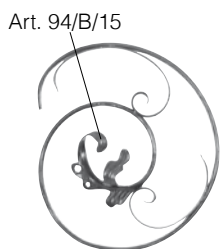

right - destro
Art. 94/E/1
Ø 12 mm
440 x 460 mm



left - sinistro
Art. 94/E/2
Ø 12 mm
440 x 460 mm

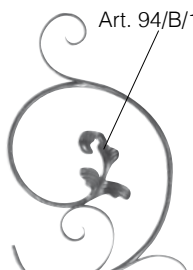

right - destro
Art. 94/E/4
Ø 12 mm
310 x 540 mm

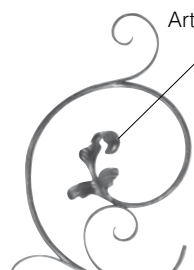

left - sinistro
Art. 94/E/3
Ø 12 mm
310 x 540 mm

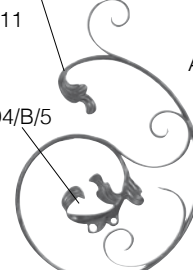

right - destro
Art. 94/E/5
Ø 12 mm
410 x 620 mm

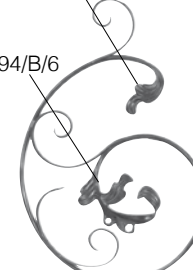

left - sinistro
Art. 94/E/6
Ø 12 mm
410 x 620 mm

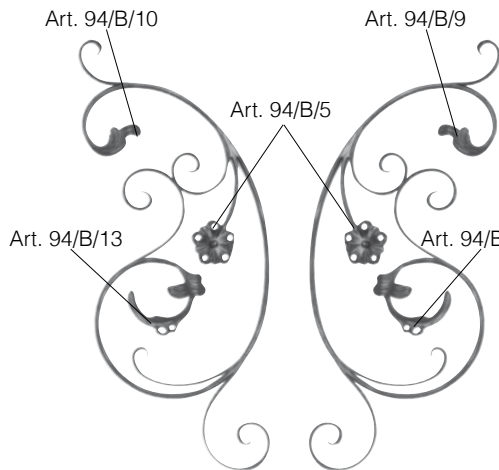

right - destro
Art. 94/F/6
Ø 12 mm
420 x 970 mm



left - sinistro
Art. 94/F/5
Ø 12 mm
420 x 970 mm

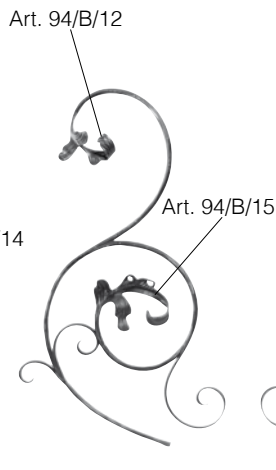

right - destro
Art. 94/F/4
Ø 12 mm
490 x 800 mm

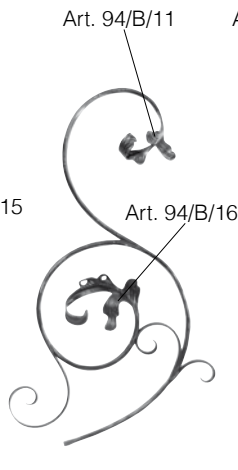

left - sinistro
Art. 94/F/3
Ø 12 mm
490 x 800 mm

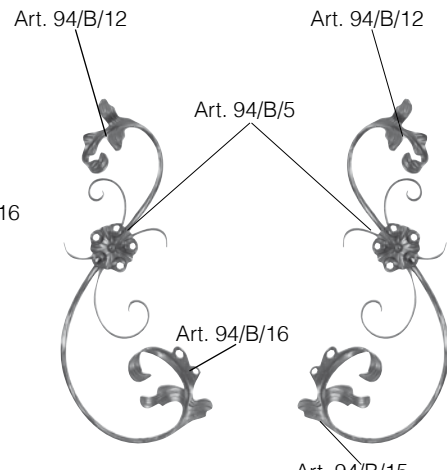

right - destro
Art. 94/F/2
Ø 12 mm
320 x 690 mm



left - sinistro
Art. 94/F/1
Ø 12 mm
320 x 690 mm

TO BE LAID OVERLAPPED ON $\varnothing 12 \times 12 \text{ mm}$
DA SOVRAPPORRE AL $\varnothing 12 \times 12 \text{ mm}$



Art. 35/1
 $\varnothing 12 \times 6 \text{ mm}$
205 x 445 mm



Art. 582/1
 $\varnothing 12 \times 6 \text{ mm}$
175 x 350 mm



Art. 35/2
 $\varnothing 12 \times 6 \text{ mm}$
200 x 345 mm

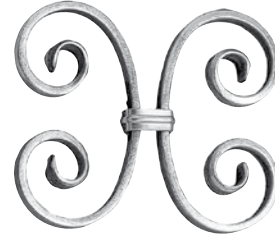

Art. 1300/2
 $\varnothing 12 \times 6 \text{ mm}$
145 x 175 mm



Art. 37/3
 $\varnothing 12 \times 6 \text{ mm}$
95 x 95 mm



A fence or a balcony made with pickets of simple plain iron, can be enhanced at a later time by the use of snap-ons

Una recinzione o un parapetto, realizzata con tamponatura in paletti di semplice ferro liscio, può essere arricchita in un secondo momento con l'utilizzo di snap-ons





arteferro
italian wrought iron

VERTICAL METALS

Si chiama Vertical Metals ed è la nuova linea di sistemi per facciate ornamentali marchiate Arteferro. Design brevettato, materiale green, può essere un rivestimento ma anche una struttura a sé stante, a copertura parziale o totale. Dalle epoche del Romanticismo e dell'Art Nouveau è la prima rielaborazione concettuale dell'utilizzo di un materiale classico come il ferro battuto che, pur mantenendo la tipica finitura artigianale, assume un design completamente nuovo dalle insolite tridimensionalità.

arteferro.com/vertical_metals

It's called Vertical Metals and is the new line for ornamental façades systems branded Arteferro. Patented design, green material, it can be a siding but also a stand-alone structure or a partial/total coverage. From the eras of Romanticism and Art Nouveau this is the first conceptual reworking of a classic material like wrought iron that, also maintaining the typical craftmade finishing, takes on a completely new design characterized by unusual tridimensionality.



www.arteferro.com

Arteferro is a division of Ind.i.a. spa (Gonzato Group)
Via Vicenza, 6/14 (SP46) – 36034 Malo (Vicenza) Italy
Tel. +39 0445 580 580 • Fax +39 0445 580 874
info@arteferro.com • www.arteferro.com

GONZATO GROUP

 **ind.i.a.**





Arteferro produces spheres with different finishes: plain, faceted, forged and hollow. The spheres are often combined with other wrought iron items, making it possible to create high quality decorative articles: they can be used as terminals for pickets or posts, as spacers, or as compositional elements for creating different organic shapes, like bunches of grapes.

Arteferro produce sfere con diverse finiture: lisce, diamantate, spicchiate e vuote. Le sfere vengono spesso abbinare ad altri elementi in ferro battuto, permettendo di realizzare manufatti decorativi di elevato pregio: possono essere utilizzate come terminali per paletti o caposaldi, come distanziali o come elementi compositivi per la realizzazione di diverse forme organiche come i grappoli d'uva.

| |  |  |   |  |  |
|----------------------|--|--|---|---|---|
| Diameter Diametro | Hot stamped plain spheres Sfere lisce stampate a caldo | Handforged spheres Sfere forgiate a mano | Hollow spheres Sfere vuote | Welded hollow spheres 12.5 mm hole 2 mm thick Sfere vuote saldate foro 12,5 mm spess. 2 mm | hollow spheres not welded 3 mm thick Sfere vuote non saldate spessore 3 mm |
| | Art. | Art. | Art. | Art. | Art. |
| Ø 16 mm | 117/1/L | BEST PRICE 117/1 | - | - | - |
| Ø 20 mm | 116/F/1 | 117/2 | - | - | - |
| Ø 22 mm | - | - | 1394/2 Hole-Foro Ø 6 mm Thickn.-Spess. 2 mm | - | - |
| Ø 25 mm | 116/F/2 | 117/3 | 1394/3 Hole-Foro Ø 6 mm Thickn.-Spess. 2 mm | 1394/25 | 1395/5 hole-foro Ø 6 mm |
| Ø 30 mm | 116/F/3 | 117/4 | 1394/4 Hole-Foro Ø 6 mm Thickn.-Spess. 2 mm | 1394/24 | 1395/4 hole-foro Ø 6 mm |
| Ø 35 mm | 123/1 | 117/5 | - | - | 1395/3 hole-foro Ø 12,5 mm |
| Ø 40 mm | 116/F/4 | 117/6 | 1394/6 Hole-Foro Ø 7 mm Thickn.-Spess. 2 mm | 1394/23 | - |
| Ø 45 mm | - | - | 1394/7 Hole-Foro Ø 8 mm Thickn.-Spess. 2 mm | - | - |
| Ø 50 mm | 116/F/5 | 117/7 | 1394/8 Hole-Foro Ø 9 mm Thickn.-Spess. 2 mm | 1394/22 | 1395/2 hole-foro Ø 16 mm |
| Ø 55 mm | - | - | 1394/9 Hole-Foro Ø 9 mm Thickn.-Spess. 2 mm | - | - |
| Ø 60 mm | 116/F/6 | 117/8 | 1394/10 Hole-Foro Ø 10 mm Thickn.-Spess. 2 mm | 1394/21 | - |
| Ø 70 mm | 116/F/7 | 117/9 | 1394/11 Hole-Foro Ø 10 mm Thickn.-Spess. 2 mm | - | - |
| Ø 80 mm | 116/F/8 | 113/12 | 1394/12 Hole-Foro Ø 11 mm Thickn.-Spess. 2 mm | - | 1395/1 hole-foro Ø 35 mm |
| Ø 90 mm | 116/F/9 | - | 1394/13 Without hole-Senza foro Thickn.-Spess. 2 mm | - | - |
| Ø 100 mm | 116/F/10 | 113/11 | 1394/14 Without hole-Senza foro Thickn.-Spess. 2 mm | - | - |
| Ø 110 mm | - | - | 1394/15 Without hole-Senza foro Thickn.-Spess. 2,5 mm | - | - |
| Ø 120 mm | 116/F/17 | 117/15 | 1394/16 Without hole-Senza foro Thickn.-Spess. 2 mm | - | - |
| Ø 130 mm | - | - | 1394/17 Without hole-Senza foro Thickn.-Spess. 2 mm | - | - |
| Ø 140 mm | - | - | 1394/18 Without hole-Senza foro Thickn.-Spess. 2 mm | - | - |
| Ø 150 mm | 116/F/19 | 117/16 | 1394/19 Without hole-Senza foro Thickn.-Spess. 2 mm | - | - |
| Ø 200 mm | - | - | 1394/20 Without hole-Senza foro Thickn.-Spess. 1,5 mm | - | - |

| |  |  |
|----------------------|---|---|
| Diameter Diametro | Half hollow spheres hole 12.5 mm 2 mm thick Mezze sfere vuote foro 12,5 mm spess. 2 mm | Half full spheres Mezze sfere piene |
| | Art. | Art. |
| Ø 25 mm | 1395/10 | - |
| Ø 30 mm | 1395/9 | - |
| Ø 35 mm | - | 819/14 H = 17,5 mm |
| Ø 40 mm | 1395/8 | 819/13 H = 20 mm |
| Ø 50 mm | 1395/7 | 819/12 H = 20 mm |
| Ø 55 mm | 1395/6 | - |
| Ø 60 mm | - | - |
| Ø 80 mm | - | - |



| |  |
|----------------------|---|
| Diameter Diametro | Pressed plain spheres Sfere lisce schiacciate |
| Ø 40 x H 25 mm | 202/7 |
| Ø 45 x H 28 mm | 202/6 |
| Ø 60 x H 35 mm | 202/5 |
| Ø 70 x H 40 mm | 202/4 |
| Ø 80 x H 51 mm | 202/3 |
| Ø 90 x H 57 mm | 202/2 |
| Ø 110 x H 67 mm | 202/1 |

| |  |
|----------------------|---|
| Diameter Diametro | Hot forged oval spheres Sfere forgiate ovali |
| Ø 28 x H 38 mm | 1396/5 |
| Ø 30 x H 50 mm | 1396/4 |
| Ø 40 x H 60 mm | 1396/3 |
| Ø 55 x H 75 mm | 1396/2 |
| Ø 65 x H 95 mm | 1396/1 |

| |  |
|----------------------|---|
| Diameter Diametro | Hot forged faceted spheres Sfere diamantate |
| Ø 20 mm | 116/F/11 |
| Ø 25 mm | 116/F/12 |
| Ø 30 mm | 116/F/13 |
| Ø 35 mm | 116/F/14 |
| Ø 40 mm | 116/F/15 |
| Ø 50 mm | 116/F/16 |
| Ø 60 mm | 116/F/18 |



BUSHES

Arteferro bushes are compositional elements that are often used for the construction of wrought iron fences, railings, gates and balconies. Available in a range of versions, stamped, lathed, forged or tubular; with or without through holes, they can be fitted to pickets or posts and serve as a decorative element.

Le borchie Arteferro sono elementi compositivi spesso utilizzati per la realizzazione di recinzioni, inferriate, cancelli e balconate in ferro battuto. Disponibili in varie versioni, stampate, tornite, forgiate o in tubolare; con o senza foro passante, possono essere assemblate ai paletti o ai piantoni e fungono da elemento decorativo.

BORCHIE

HAND FORGED BUSHES - BORCHIE FORGIATE A MANO



Art. 1389/1
33 x 200 mm
□ 12 x 12 mm



Art. 1389/2
53 x 200 mm
□ 12 x 12 mm



Art. 1389/3
53 x 200 mm
Ø 12 mm



Art. 1389/4
30 x 150 mm
□ 12 x 12 mm



Art. 1389/5
30 x 150 mm
□ 12 x 12 mm



Art. 1389/6
30 x 150 mm
Ø 12 mm



Art. 738/1
37 x 150 mm
Ø 12 mm



Art. 738/2
35 x 120 mm
Ø 12 mm



Art. 738/3
45 x 120 mm
Ø 12 mm



Art. 738/4
35 x 120 mm
Ø 12 mm



Art. 738/5
50 x 170 mm
□ 14 x 14 mm



Art. 738/6
50 x 170 mm
□ 14 x 14 mm



Art. 738/7
40 x 170 mm
Ø 12 mm



Art. 738/8
42 x 120 mm
Ø 12 mm



Art. 738/9
40 x 120 mm
Ø 12 mm



Art. 738/10
70 x 150 mm
Ø 30 mm



Art. 738/11
70 x 150 mm
Ø 30 mm



H 40 mm
Ø 45 mm

Art. 737/1
hole - foro
for/per Ø 16 mm

Art. 737/2
hole - foro
for/per Ø 18 mm

Art. 737/3
hole - foro
for/per Ø 20 mm



H 68 mm
Ø 45 mm

Art. 737/4
hole - foro
for/per Ø 16 mm

Art. 737/5
hole - foro
for/per Ø 18 mm

Art. 737/6
hole - foro
for/per Ø 20 mm



Art. 737/7
H 40 mm
L 42 mm



Art. 737/8
H 85 mm
L 42 mm

TUBE BUSHING
 Ø 30 mm thickness 1,5 mm

BORCHIE IN TUBO
 Ø 30 mm spessore 1,5 mm



Art. 1243/1
 H 180 mm
 Ø 30 mm
 hole for
 foro per
 Ø 12 mm



Art. 1243/2
 H 140 mm
 Ø 30 mm
 hole for
 foro per
 Ø 12 mm



Art. 1243/3
 H 60 mm
 Ø 30 mm
 hole for
 foro per
 Ø 12 mm



Art. 1243/4
 H 150 mm
 Ø 30 mm
 hole for
 foro per
 Ø 12 mm



Art. 1243/5
 H 330 mm
 Ø 30 mm
 hole for
 foro per
 Ø 12 mm



Art. 1243/6
 H 185 mm
 Ø 30 mm
 hole for
 foro per
 Ø 12 mm



Art. 1243/7
 H 100 mm
 Ø 30 mm
 hole for
 foro per
 Ø 12 mm



Art. 1243/8
 H 70 mm
 Ø 30 mm
 hole for
 foro per
 Ø 12 mm



Art. 1243/9
 H 155 mm
 Ø 30 mm
 hole for
 foro per
 Ø 12 mm



Art. 1243/10
 H 145 mm
 Ø 30 mm
 hole for
 foro per
 Ø 12 mm



Art. 1243/11
 H 155 mm
 Ø 30 mm
 hole for
 foro per
 Ø 12 mm



Art. 1243/12
 H 90 mm
 Ø 30 mm
 hole for
 foro per
 Ø 12 mm



TUBE BUSHING - BORCHIE IN TUBO

Ø 30 mm thickn.-spess. 1,5 mm - Ø 40 mm thickn.-spess. 2 mm - Ø 50 mm thickn.-spess. 2 mm



Art. 154/1
H 120 mm
Ø 30 mm

hole for - foro per dia.
Ø 12 mm



Art. 154/2
H 150 mm
Ø 30 mm

hole for - foro per dia.
Ø 12 mm



Art. 154/3
H 105 mm
Ø 30 mm

hole for - foro per dia.
Ø 12 mm



Art. 154/4
H 140 mm
Ø 30 mm

hole for - foro per dia.
Ø 12 mm



Art. 154/5
H 100 mm
Ø 30 mm

hole for - foro per dia.
Ø 12 mm

Art. 154/A/3

H 180 mm
Ø 40 mm

hole for - foro per dia.
Ø 16 mm



Art. 154/A/1
H 105 mm
Ø 40 mm

hole for - foro per dia.
Ø 14 mm



Art. 154/A/2
H 75 mm
Ø 40 mm

hole for - foro per dia.
Ø 14 mm



Art. 154/A/4
H 120 mm
Ø 40 mm

hole for - foro per dia.
Ø 16 mm



Art. 155/1
H 85 mm
Ø 30 mm

hole for - foro per dia.
Ø 12 mm



Art. 155/5
H 85 mm
Ø 30 mm

hole for - foro per dia.
Ø 12 mm



Art. 155/6
H 65 mm
Ø 30 mm

hole for - foro per dia.
Ø 12 mm

Art. 154/A/5

H 105 mm
Ø 40 mm

hole for - foro per dia.
Ø 16 mm

Art. 154/A/6

H 75 mm
Ø 40 mm

hole for - foro per dia.
Ø 16 mm

Art. 154/B/1

H 105 mm
Ø 40 mm

hole for - foro per dia.
Ø 12 mm

Art. 154/B/2

H 75 mm
Ø 40 mm

hole for - foro per dia.
Ø 12 mm

Art. 155/2

H 65 mm
Ø 30 mm

hole for - foro per dia.
Ø 12 mm

Art. 155/3

H 50 mm
Ø 30 mm

hole for - foro per dia.
Ø 12 mm



Art. 155/4
H 20 mm
Ø 30 mm

hole for - foro per dia.
Ø 12 mm



Art. 155/7
H 30 mm
Ø 30 mm

hole for - foro per dia.
Ø 12 mm



Art. 154/B/3
H 120 mm
Ø 40 mm

hole for - foro per dia.
Ø 14 mm



Art. 154/B/5
H 95 mm
Ø 40 mm

hole for - foro per dia.
Ø 14 mm



Art. 1793/7
H 83 mm
Ø 50 mm

hole for - foro per dia.
Ø 22 mm



Art. 1793/8
H 65 mm
Ø 50 mm

hole for - foro per dia.
Ø 22 mm

Art. 154/A/7

H 25 mm
Ø 40 mm

hole for - foro per dia.
Ø 16 mm

Art. 154/A/8

H 45 mm
Ø 40 mm

hole for - foro per dia.
16 mm

Art. 154/B/4

H 120 mm
Ø 40 mm

hole for - foro per dia.
Ø 16 mm

Art. 154/B/6

H 95 mm
Ø 40 mm

hole for - foro per dia.
Ø 16 mm

TUBE BUSHING - BORCHIE IN TUBO

hole for - foro per dia. 12 mm

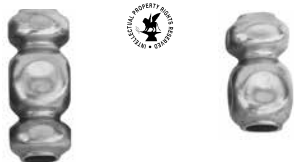

Art. 742/3
H 65 mm
25 x 25 mm
thickn.-spess.
1,5 mm

Art. 742/4
H 50 mm
25 x 25 mm
thickn.-spess.
1,5 mm

hole for - foro per dia. 14 mm



Art. 742/1
H 105 mm
34 x 34 mm
thickn.-spess.
2 mm

Art. 742/2
H 75 mm
34 x 34 mm
thickn.-spess.
2 mm

hole for - foro per dia. 14 mm



Art. 742/5
H 120 mm
34 x 34 mm
thickn.-spess.
2 mm

Art. 742/6
H 90 mm
34 x 34 mm
thickn.-spess.
2 mm

GROOVED STEEL TUBE BUSHING - BORCHIE IN TUBO RIGATO

Hole for - Foro per dia. 12 mm thickn. - spess. 1,5 mm



Art. 1244/4
H 150 mm
Ø 30 mm



Art. 1244/1
H 180 mm
Ø 30 mm



Art. 1244/2
H 140 mm
Ø 30 mm



Art. 1244/3
H 60 mm
Ø 30 mm



Art. 1244/8
H 70 mm
Ø 30 mm



Art. 1244/7
H 100 mm
Ø 30 mm



Art. 1244/6
H 185 mm
Ø 30 mm



Art. 1244/5
H 330 mm
Ø 30 mm



Art. 1244/9
H 140 mm
Ø 30 mm



Art. 1244/10
H 85 mm
Ø 30 mm



Art. 1244/11
H 100 mm
Ø 30 mm



Art. 1244/12
H 120 mm
Ø 30 mm



Art. 1244/13
H 85 mm
Ø 30 mm



Art. 1244/14
H 65 mm
Ø 30 mm



Art. 1244/15
H 30 mm
Ø 30 mm



Art. 1244/16
H 155 mm
Ø 30 mm



Art. 1244/17
H 145 mm
Ø 30 mm



Art. 1244/18
H 155 mm
Ø 30 mm



Art. 1244/19
H 90 mm
Ø 30 mm



Art. 1244/20
H 150 mm
Ø 30 mm



Art. 1244/21
H 105 mm
Ø 30 mm



Art. 1244/22
H 65 mm
Ø 30 mm



Art. 1244/23
H 50 mm
Ø 30 mm

STAMPED AND CAST BUSHES- BORCHIE STAMPATE E DI FUSIONE

| Dimensions Dimensioni | Section Sezione | hole - foro | | Hole - Foro | |
|--------------------------|-------------------------|---------------|---------------|-------------|----------------|
| | | Art. | Art. | Art. | Art. |
| H 63 mm Ø 38 mm | Without hole-Senza foro | 128/3 | - | - | - |
| | 12 mm | 128/6 | 747/18 | 12 x 12 mm | 126/F/1 |
| | 14 mm | 128/7 | 747/19 | 14 x 14 mm | - |
| | 16 mm | 128/8 | 747/20 | 16 x 16 mm | - |
| H 68 mm Ø 45 mm | Without hole-Senza foro | 128/4 | - | - | - |
| | 12 mm | - | - | 12 x 12 mm | 126/F/2 |
| | 14 mm | - | - | 14 x 14 mm | 126/F/3 |
| | 16 mm | 128/9 | - | 16 x 16 mm | - |
| | 18 mm | 128/10 | - | 18 x 18 mm | - |
| | 20 mm | 128/11 | - | 20 x 20 mm | - |
| H 78 mm Ø 50 mm | Without hole-Senza foro | 128/5 | - | - | - |
| | 12 mm | - | - | 12 x 12 mm | - |
| | 14 mm | - | - | 14 x 14 mm | 126/F/4 |
| | 16 mm | 128/12 | - | 16 x 16 mm | 126/F/5 |
| | 18 mm | 128/13 | - | 18 x 18 mm | - |
| | 20 mm | 128/14 | - | 20 x 20 mm | - |
| | 22 mm | 128/15 | - | 22 x 22 mm | - |

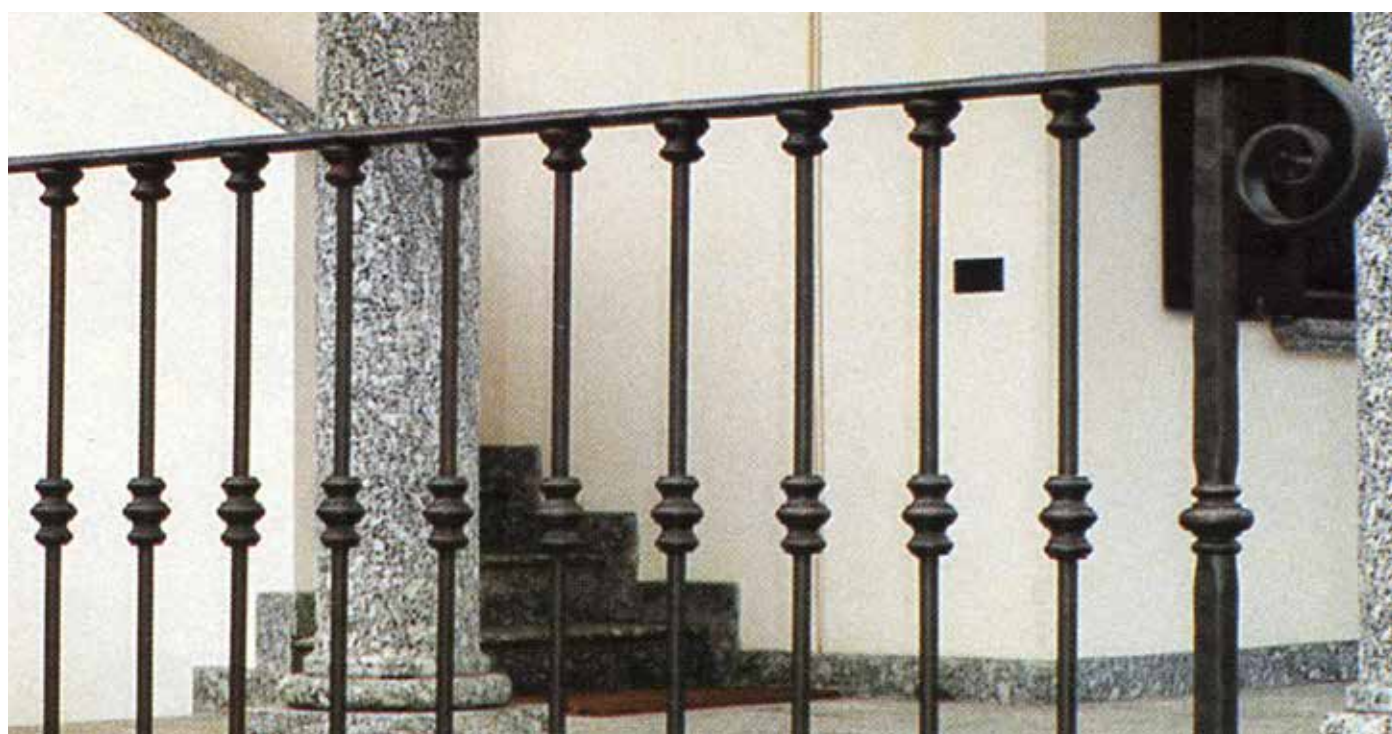

STAMPED AND CAST BUSHES - BORCHIE STAMPATE E DI FUSIONE

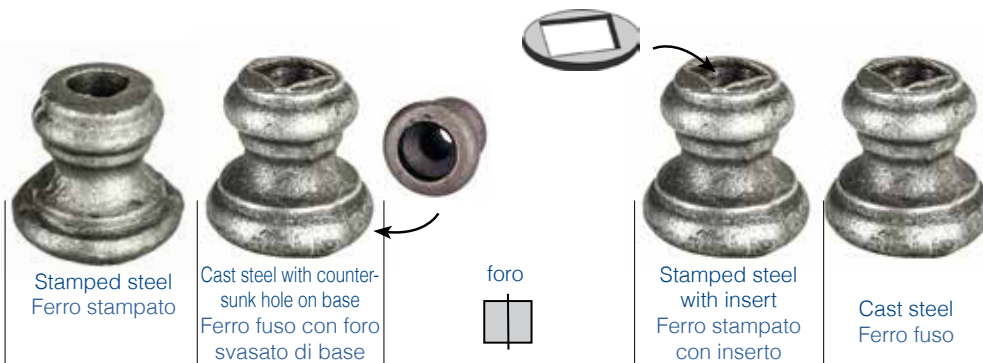

| Dimensions Dimensioni | Section Sezione | Art. | Art. | Section Sezione | Art. | Art. |
|--------------------------|-------------------------|--------|--------|-------------------------|----------|--------|
| H 35 mm Ø 38 mm | Without hole-Senza foro | 128/16 | - | Without hole-Senza foro | - | - |
| | 12 mm | 128/17 | 747/21 | 12 x 12 mm | 126/F/6 | 747/15 |
| | 14 mm | 128/18 | 747/22 | 14 x 14 mm | - | - |
| | 16 mm | 128/19 | 747/23 | 16 x 16 mm | - | - |
| H 44 mm Ø 45 mm | Without hole-Senza foro | 128/20 | - | - | - | - |
| | 12 mm | - | - | 12 x 12 mm | 126/F/7 | 1392/3 |
| | 14 mm | - | - | 14 x 14 mm | 126/F/8 | 747/16 |
| | 16 mm | 128/21 | - | 16 x 16 mm | - | - |
| | 18 mm | 128/22 | - | 18 x 18 mm | - | - |
| | 20 mm | 128/23 | - | 20 x 20 mm | - | - |
| H 46 mm Ø 50 mm | Without hole-Senza foro | 128/24 | - | - | - | - |
| | 12 mm | - | - | 12 x 12 mm | - | - |
| | 14 mm | - | - | 14 x 14 mm | 126/F/9 | 1392/4 |
| | 16 mm | 128/25 | - | 16 x 16 mm | 126/F/10 | 747/17 |
| | 18 mm | 128/26 | - | 18 x 18 mm | - | - |
| | 20 mm | 128/27 | - | 20 x 20 mm | - | - |
| | 22 mm | 128/28 | - | 22 x 22 mm | - | - |



Ø 40 mm - H 23 mm

hole - foro



| Hole for section Foro per sezione | Art. |
|--------------------------------------|--------|
| 12 x 12 mm | 128/38 |
| 14 x 14 mm | 128/2 |
| 16 x 16 mm | 128/39 |



Ø 40 mm - H 24 mm

hole - foro



| Hole for section Foro per sezione | Art. |
|--------------------------------------|---------|
| 12 x 12 mm | 1393/25 |
| 14 x 14 mm | 1393/26 |



L 33 mm - H 22 mm

hole - foro



| Hole for section Foro per sezione | Art. |
|--------------------------------------|---------|
| 12 x 12 mm | 1393/19 |

L 55 mm - H 35 mm

hole - foro



| Hole for section Foro per sezione | Art. |
|--------------------------------------|---------|
| 20 x 20 mm | 1393/18 |

hole - foro



| Hole for diameter Foro per diametro | Art. |
|--|--------|
| Ø 12 mm | 128/36 |
| Ø 14 mm | 128/1 |
| Ø 16 mm | 128/37 |

hole - foro



| Hole for diameter Foro per diametro | Art. |
|--|---------|
| Ø 12 mm | 1393/27 |
| Ø 14 mm | 1393/28 |

STAMPED BUSHES - BORCHIE STAMPATE



Hot stamped
Stampata a caldo
Ø 35 mm - H 63 mm



| Hole for dia. - Foro per dia. | Art. |
|-------------------------------|-----------------|
| Without hole - Senza Foro | 126/F/11 |
| 12 mm | 739/4 |
| 14 mm | 739/5 |
| 16 mm | 739/6 |



Hot stamped
Stampata a caldo
Ø 35 mm - H 40 mm



| Hole for dia. - Foro per dia. | Art. |
|-------------------------------|---------------|
| 12 mm | 1854/1 |
| 14 mm | 1854/2 |



Hot stamped with insert
Stampata a caldo con inserto
Ø 35 mm - H 40 mm



| hole for sec. - foro per sez. | Art. |
|-------------------------------|---------------|
| 12 x 12 mm | 1854/3 |



Hot stamped
Stampata a caldo
Ø 60 mm - H 65 mm



| Hole for dia. - Foro per dia. | Art. |
|-------------------------------|----------------|
| 16 mm | 1393/20 |
| 20 mm | 1393/21 |
| 24 mm | 1393/22 |



Cast steel
Ferro fuso
Ø 60 mm - H 65 mm



| hole for sec. - foro per sez. | Art. |
|-------------------------------|----------------|
| 14 x 14 mm | 1393/23 |
| 16 x 16 mm | 1393/24 |



Not all of the Arteferro items are available in **Arteferro Quick**, just a special selection. Find out about the entire range in the catalogue

In **Arteferro Quick** non sono presenti tutti gli articoli Arteferro, ma solo una speciale selezione. Scopri la gamma completa nel catalogo

Compendium



Hot stamped with insert
Stampata a caldo con inserto
Ø 45 mm - H 54 mm



| hole for sec. - foro per sez. | Art. |
|-------------------------------|-----------------|
| Without hole - Senza Foro | 126/F/12 |
| 12 x 12 mm | 126/F/13 |
| 14 x 14 mm | 126/F/14 |



Cast steel
Ferro fuso
Ø 45 mm - H 54 mm



| hole for sec. - foro per sez. | Art. |
|-------------------------------|---------------|
| Without hole - Senza Foro | 1392/5 |
| 12 x 12 mm | 1392/6 |
| 14 x 14 mm | 1392/7 |



Hot stamped
Stampata a caldo
Ø 45 mm - H 54 mm



| Hole for dia. - Foro per dia. | Art. |
|-------------------------------|--------------|
| 12 mm | 739/1 |
| 14 mm | 739/2 |
| 16 mm | 739/3 |

STAMPED BUSHES - BORCHIE STAMPATE



H 120 mm
Ø 32 mm

H 63 mm
Ø 32 mm

| | | |
|-------------------------------|----------|----------|
| Hole for dia. - Foro per dia. | Art. | Art. |
| Without hole - Senza foro | - | 128/C/15 |
| Ø 12 mm | 128/C/9 | 128/C/12 |
| Ø 14 mm | 128/C/10 | 128/C/13 |
| Ø 16 mm | 128/C/11 | 128/C/14 |



H 78 mm
Ø 69 mm

H 50 mm
Ø 69 mm

| | | |
|-------------------------------|---------|-------|
| Hole for dia. - Foro per dia. | Art. | Art. |
| Without hole - Senza foro | 128/C/3 | 741/6 |
| Ø 20 mm | 128/C/4 | 741/1 |
| Ø 25 mm | 128/C/5 | 741/2 |
| Ø 30 mm | 128/C/6 | 741/3 |
| Ø 35 mm | 128/C/7 | 741/4 |
| Ø 40 mm | 128/C/8 | 741/5 |



Cast steel
Ferro fuso
H 78 mm
Ø 69 mm

| | |
|-------------------------------|-------|
| hole for sec. - foro per sez. | Art. |
| 25 x 25 mm | 741/7 |
| 30 x 30 mm | 741/8 |



Arteferro products are available in raw metal as well as sandblasted or galvanized on request.

I prodotti Arteferro sono disponibili in metallo grezzo e, su richiesta, anche sabbiati o zincati a freddo.



| Dim. | Art. | Art. | Art. | Art. |
|--------------------|--|--|---|---|
| H 55 mm Ø 35 mm | 1393/14 hole for dia. - foro per dia. Ø 12 mm | 1393/15 hole for dia. - foro per dia. Ø 14 mm | 1393/16 hole for sec. - foro per sez. ⌀ 12 x 12 mm | - |
| H 75 mm Ø 50 mm | 1393/10 hole for dia. - foro per dia. Ø 18 mm | 1393/11 hole for dia. - foro per dia. Ø 20 mm | 1393/12 hole for sec. - foro per sez. ⌀ 14 x 14 mm | 1393/13 hole for sec. - foro per sez. ⌀ 16 x 16 mm |



| |  | Stamped steel with insert Ferro stampato con inserto | Cast steel Ferro fuso | Cast steel Ferro fuso | Cast steel Ferro fuso |
|--------------------|---|---|--------------------------|--------------------------|--------------------------|
| Dim. | Hole for sec. - Foro per sez. | Art. | Art. | Art. | Art. |
| H 45 mm L 40 mm | 12 x 12 mm | - | - | - | 1391/21 |
| | 14 x 14 mm | - | - | - | 1391/22 |
| | 16 x 16 mm | - | - | - | 1391/23 |
| H 65 mm L 40 mm | 12 x 12 mm | - | - | 1391/4 | - |
| | 14 x 14 mm | - | - | 1391/5 | - |
| | 16 x 16 mm | - | - | 1391/6 | - |
| H 67 mm L 40 mm | Without hole-Senza foro | 127/5 | 1391/18 | - | - |
| | 12 x 12 mm | 127/7 | 1391/7 | - | - |
| | 14 x 14 mm | 127/8 | 1391/8 | - | - |
| | 16 x 16 mm | 127/9 | 1391/9 | - | - |
| H 88 mm L 45 mm | Without hole-Senza foro | 127/3 | 1391/17 | - | - |
| | 14 x 14 mm | 127/10 | 1391/10 | - | - |
| | 16 x 16 mm | 127/11 | 1391/11 | - | - |



Arteferro products are available in raw metal as well as sandblasted or galvanized on request.

I prodotti Arteferro sono disponibili in metallo grezzo e, su richiesta, anche sabbiati o zincati a freddo.



| |  | Stamped steel with insert Ferro stampato con inserto | Cast steel Ferro fuso | Cast steel Ferro fuso |
|--------------------|---|---|--------------------------|--------------------------|
| Dimens. | Hole for sec. - Foro per sez. | Art. | Art. | Art. |
| H 38 mm L 40 mm | Without hole - Senza Foro | 127/6 | 1391/20 | - |
| | 12 x 12 mm | 127/12 | 1391/12 | - |
| | 14 x 14 mm | 127/13 | 1391/13 | - |
| | 16 x 16 mm | 127/14 | 1391/14 | - |
| H 40 mm L 40 mm | 12 x 12 mm | - | - | 1391/1 |
| | 14 x 14 mm | - | - | 1391/2 |
| | 16 x 16 mm | - | - | 1391/3 |
| H 45 mm L 45 mm | Without hole - Senza Foro | 127/4 | 1391/19 | - |
| | 14 x 14 mm | 127/15 | 1391/15 | - |
| | 16 x 16 mm | 127/16 | 1391/16 | - |





Arteferro baskets are central decorations, and are installed by welding the ends to the pickets they are inserted into. Their ornamental function confers an artistic dynamism to any structural element they are applied to, creating an elegant and sinuous wrought iron artefact.

Le pigne Arteferro sono decori centrali e vengono installate saldandone le estremità al paletto nel quale vengono inserite. La loro funzione ornamentale conferisce dinamicità artistica all'elemento strutturale al quale vien applicata, creando un manufatto in ferro battuto elegante e sinuoso.

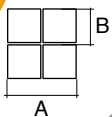

| Art. | Ø | H | A | B |
|-------------------------|--------|--------|------------|------------|
| 159/1 | 35 mm | 90 mm | 8 x 8 mm | 4 x 4 mm |
| 159/2 | 55 mm | 110 mm | 10 x 10 mm | 5 x 5 mm |
| 159/3 BEST PRICE | 60 mm | 125 mm | 12 x 12 mm | 6 x 6 mm |
| 159/4 | 60 mm | 125 mm | 14 x 14 mm | 7 x 7 mm |
| 159/5 | 65 mm | 145 mm | 16 x 16 mm | 8 x 8 mm |
| 159/6 | 80 mm | 165 mm | 20 x 20 mm | 10 x 10 mm |
| 159/7 | 95 mm | 180 mm | 24 x 24 mm | 12 x 12 mm |
| 159/9 | 100 mm | 220 mm | 30 x 30 mm | 15 x 15 mm |
| 159/10 | 130 mm | 280 mm | 40 x 40 mm | 20 x 20 mm |

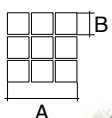

| Art. | Ø | H | A | B |
|---------|-------|--------|------------|------------|
| 158/B/1 | 55 mm | 130 mm | 12 x 12 mm | 4 x 4 mm |
| 158/B/2 | 60 mm | 145 mm | 15 x 15 mm | 5 x 5 mm |
| 158/B/3 | 80 mm | 170 mm | 21 x 21 mm | 7 x 7 mm |
| 158/B/4 | 95 mm | 220 mm | 24 x 24 mm | 8 x 8 mm |
| 158/B/5 | 95 mm | 270 mm | 30 x 30 mm | 10 x 10 mm |



The baskets were included in our product range in 1981 in response to requests from the emerging German market

Le pigne sono state inserite nella nostra produzione nel 1981 per rispondere alla richiesta dell'emergente mercato tedesco

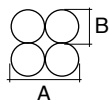
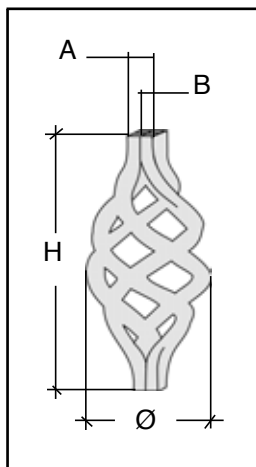

BASKETS WITH ROD - PIGNE CON TONDINO

| Art. | Ø | H | A | B |
|--------|--------|--------|------------|---------|
| 1163/1 | 35 mm | 90 mm | 8 x 8 mm | Ø 4 mm |
| 1163/2 | 55 mm | 110 mm | 10 x 10 mm | Ø 5 mm |
| 1163/3 | 55 mm | 125 mm | 12 x 12 mm | Ø 6 mm |
| 1163/4 | 60 mm | 125 mm | 14 x 14 mm | Ø 7 mm |
| 1163/5 | 70 mm | 145 mm | 16 x 16 mm | Ø 8 mm |
| 1163/6 | 75 mm | 165 mm | 20 x 20 mm | Ø 10 mm |
| 1163/7 | 100 mm | 180 mm | 24 x 24 mm | Ø 12 mm |
| 1163/8 | 110 mm | 220 mm | 30 x 30 mm | Ø 15 mm |



Art. 1163/10
 Ø 70 mm
 B = 8 x 8 mm



Art. 158/B/7
 Ø 70 mm
 B = 6 x 6 mm



Art. 158/B/6
 Ø 70 mm
 B = 8 x 8 mm



Art. 1163/12
 Ø 90 mm
 B = 6 x 6 mm

Art. 1163/11
 Ø 115 mm
 B = 12 x 12 mm

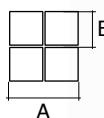

Art. 158/B/8
 Ø 40 mm
 H 125 mm
 A = 12 x 12 mm
 B = 6 x 6 mm



Art. 1163/9
 Ø 70 mm
 B = Ø 6 mm

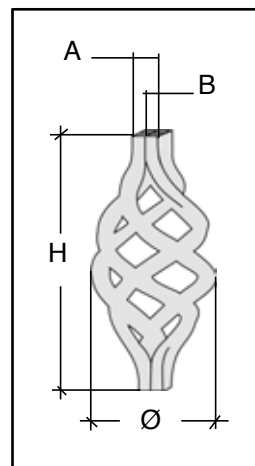

Art. 1164/3
 Ø 80 mm
 H 180 mm
 A = Ø 20 mm
 B = 10 x 10 mm
 Hole - Foro Ø 10 mm



Art. 1164/2
 Ø 70 mm
 B = 6 x 6 mm
 Hole - Foro Ø 6 mm

Art. 1164/4
 Ø 75 mm
 H 160 mm
 A = Ø 16 mm
 B = 8 x 8 mm
 Hole - Foro Ø 8 mm

Art. 1164/5
 Ø 60 mm
 H 125 mm
 A = Ø 12 mm
 B = 6 x 6 mm
 Hole - Foro Ø 6 mm



Art. 1164/1
 Ø 90 mm
 B = 6 x 6 mm
 Hole - Foro Ø 6 mm





The flowers and ornaments made by Arteferro are mainly characterised by floral motifs, threadlike ribs and metallic decorations inspired by nature. They find an application in various contexts and can embellish and enhance the structure they seem to be growing from.

I fiori e gli ornamenti realizzati da Arteferro sono principalmente caratterizzati da motivi floreali, nervature filiformi e decorazioni metalliche si ispirano alla natura. Trovano applicazione in diversi contesti e sono in grado di arricchire e valorizzare il manufatto dal quale sembreranno sbocciare.

FIORI E ROSETTE

FLOWERS AND ROSETTES

Cast steel
Ferro fusoArt. 40/B/12
Ø 48 mm
Ø 2 mmArt. 1393/6
Ø 55 mm
Spess. 8 mmArt. 138/1
10 mm - Ø 60 mm
Ø 2 mmArt. 138/2
Ø 60 mm
Ø 2 mmArt. 138/15
Ø 60 mm
Ø 2 mmArt. 664/1
Ø 60 mm
Foro Ø 8 mm
Ø 3 mmArt. 116/A/4
Ø 65 mm
Ø 3 mmArt. 697/4
Ø 65 mm
Ø 3 mmArt. 1393/5
Ø 90 mm
Spess. 8 mmArt. 660/11
Ø 90 mm
Ø 4 mmArt. 660/12
Ø 90 mm
Ø 4 mmArt. 697/1
Ø 90 mm
Ø 3 mm

Ferro fuso

Art. 664/2
Ø 90 mm
Foro Ø 16 mm
Ø 3 mmArt. 116/A/3
Ø 95 mm
Ø 3 mmArt. 116/A/5
Ø 95 mm
Ø 3 mmArt. 697/3
Ø 95 mm
Ø 3 mmArt. 94/B/5
Ø 105 mm
Ø 4 mmArt. 711/5
17 mm - Ø 107 mm
Ø 0,5 mm

116/A/3+116/A/4 + 41/5

Art. 94/B/6
Ø 115 mm
Ø 4 mmArt. 660/10
Ø 115 mm
Ø 4 mmArt. 1393/4
Ø 125 mm
Spess. 8 mmArt. 705/1
20 mm - Ø 46 mm
Thread - Filetto M3
Ø 0,3 mmArt. 695/4
Ø 85 mm
Ø 4 mmArt. 138/4
10 mm - Ø 90 mm
Ø 2 mmArt. 701/5
50 mm - Ø 110 mm
Ø 0,4 mmArt. 665/1
Ø 130 mm
Ø 4 mmArt. 665/2
Ø 140 mm
Ø 4 mmArt. 711/3
Ø 140 mm
Ø 2 mmArt. 711/6
28 mm - Ø 150 mm
Ø 0,3 mmArt. 1328/6
30 mm - Ø 180 mm
Ø 4 mm



Art. 705/3
45 mm - Ø 55 mm
Thread - Filetto M3
Ø 0,3 mm



Art. 705/5
36 mm - Ø 40 mm
Thread - Filetto M3
Ø 0,3 mm



Art. 701/6
40 mm - Ø 65 mm
Ø 0,3 mm



Art. 700/1
45 mm - Ø 60 mm
Ø 1 mm



Art. 700/5
H 45 mm - Ø 30 mm
Ø 1 mm



Art. 140/1/3
68 mm - Ø 60 mm
Ø 4 mm



Art. 700/10
Ø 6 mm
H 320 mm



Art. 700/4
Ø 5 mm
H 300 mm



Art. 691/6
80 x 100 mm
Ø 12 mm
Ø 5 mm



Art. 691/7
80 x 100 mm
Ø 12 mm
Ø 5 mm



Art. 140/1/2
H 110 x L 50 mm
Ø 4 mm



Art. 666/2
55 x 90 mm
Ø 4 mm



Art. 666/5
45 x 190 mm
Ø 4 mm



Art. 666/6
77 x 240 mm
Ø 4 mm



Art. 750/3
Ø 35 mm
H 195 mm



Art. 692/8
100 x 330 mm
Ø 4 mm



Art. 666/9
155 x 390 mm
Ø 4 mm



Art. 136/3
70 x 60 mm
Ø 2,5 mm



Art. 136/4
70 x 60 mm
Ø 2,5 mm



Art. 140/F/4
H 160 x L 70 mm
Ø 5 mm



Art. 140/F/3
H 160 x L 70 mm
Ø 5 mm



Art. 136/1
110 x 40 mm
Ø 3 mm
Art. 136/13
90 x 30 mm
Ø 3 mm



Art. 136/2
110 x 40 mm
Ø 3 mm
Art. 136/12
90 x 30 mm
Ø 3 mm



Art. 1328/3
Stem-Gambo
Ø 6 mm
H 200 x L 45 mm

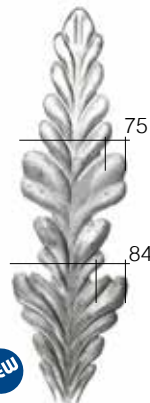

Art. 717/5/S1
H 285 mm
Ø 2 mm

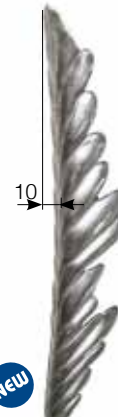

Art. 717/5/S3
L 25 x H 290 mm
Ø 2 mm



Art. 717/5/S4
L 25 x H 285 mm
Ø 2 mm



Stamped
Stampata

Art. 751/1
95 x 185 mm



stem - gambo Ø 12 mm

Art. 94/B/11
180 x 130 mm
□ 4 mm



Art. 94/B/12
180 x 130 mm
□ 4 mm



stem - gambo Ø 12 mm

Art. 94/B/7
90 x 65 mm
□ 4 mm



Art. 94/B/8
90 x 65 mm
□ 4 mm



Forged - Forgiato
Art. 140/H/1
130 x 270 mm



Forged - Forgiato
Art. 140/H/2
90 x 170 mm



Forged - Forgiato
Art. 673/2
170 x 90 mm

CAST STEEL - FERRO FUSO



Art. 662/5
□ 16 x 6 mm
150 x 250 mm



Art. 662/6
□ 16 x 6 mm
150 x 250 mm



Art. 662/1
□ 16 x 8 mm
105 x 220 mm



Art. 662/2
□ 16 x 8 mm
105 x 220 mm



Art. 661/1
□ 16 x 8 mm
140 x 155 mm



Art. 661/2
□ 16 x 8 mm
140 x 155 mm



Art. 663/5
Ø 12 mm
115 x 180 mm



Art. 663/6
Ø 12 mm
115 x 180 mm



Art. 663/1
□ 16 x 6 mm
110 x 140 mm



Art. 663/2
□ 16 x 6 mm
110 x 140 mm



Art. 661/3
Ø 8 mm
110 x 155 mm



Art. 661/4
Ø 8 mm
75 x 125 mm
Art. 661/5
Ø 6 mm
80 x 125 mm



Art. 664/8
130 x 250 mm
□ 3 mm



Art. 664/7
50 x 285 mm
□ 3 mm



Arteferro manufactures an entire range of wrought iron elements including: meshes, plates, cover plates, mailboxes, letters and numbers, symbols, hinges and weather vanes.

Arteferro realizza molteplici elementi in ferro battuto come ad esempio: maglie, piastre, copri maniglia, cassette postali, lettere e numeri, simboli, cerniere e segnamento.

DECORI IN LAMIERA

DECORATIONS IN STEEL SHEET



Art. 852/8

spess. 6 mm

H 70 mm - L 1218 mm

Art. 852/9

thickn.-spess. 2 mm

H 45 mm - L 1212 mm



Art. 852/10

thickn.-spess. 8 mm

H 124 mm - L 1206 mm

Art. 852/11

thickn.-spess. 2 mm

H 45 mm - L 1215 mm



Art. 852/6

thickn.-spess. 6 mm

H 84 mm - L 1152 mm

Art. 852/7

thickn.-spess. 2 mm

H 45 mm - L 1213 mm



Art. 852/12

thickn.-spess. 6 mm

H 70 mm - L 1196 mm

Art. 852/13

thickn.-spess. 2 mm

H 45 mm - L 1212 mm



Art. 852/14

thickn.-spess. 6 mm

H 84 mm - L 1160 mm

Art. 852/15

thickn.-spess. 2 mm

H 45 mm - L 1242 mm

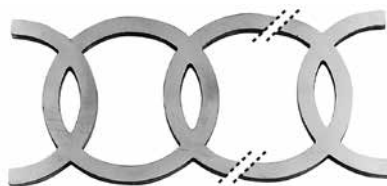

Art. 852/4

thickn.-spess. 8 mm

H 124 mm - L 1129 mm



Art. 852/5

thickn.-spess. 6 mm

H 84 mm - L 1140 mm



Art. 1813/1

14 x 6 mm

H 155 mm

L 755 mm



Art. 1813/2

14 x 6 mm

H 155 mm

L 250 mm



BEST PRICE



Art. 1813/6

14 x 6 mm

H 190 mm

L 960 mm





thickn.-spess. 3 mm - H 55 mm - L 1000 mm
Art. 1409/1
 plain - liscio



thickn.-spess. 3 mm - H 55 mm - L 990 mm
Art. 1410/1
 stamped - coniato



thickn.-spess. 3 mm - H 55 mm - L 990 mm
Art. 1409/2
 plain - liscio



thickn.-spess. 3 mm - H 45 mm - L 990 mm
Art. 1410/2
 stamped - coniato



thickn.-spess. 3 mm - H 37 mm - L 990 mm
Art. 1409/3
 plain - liscio



thickn.-spess. 3 mm - H 63 mm - L 960 mm
Art. 1410/3
 stamped - coniato



thickn.-spess. 3 mm - H 55 mm - L 960 mm
Art. 1409/4
 plain - liscio



thickn.-spess. 3 mm - H 55 mm - L 993 mm
Art. 1410/4
 stamped - coniato

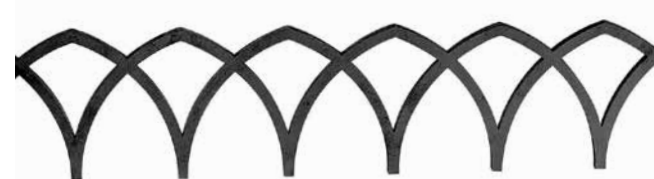

Art. 1411/1
 12 x 6 mm - H 165 mm - L 1230 mm



Art. 1411/2
 12 x 6 mm - H 165 mm - L 1160 mm - incl. 30°



Art. 1411/3
 thickn.-spess. 2 mm - H 45 mm - L 1230 mm
Art. 1411/4
 thickn.-spess. 6 mm - H 84 mm - L 1250 mm



Art. 1411/5
 thickn.-spess. 6 mm - H 84 mm - L 1225 mm
 incl. 30°

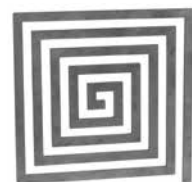

Art. 1411/6
 10 x 5 mm
 H 200 mm
 L 200 mm



Art. 1411/9
 thickn.-spess.
 5 mm
 Ø 100 mm



12 x 12 mm
Art. 1321/1
 100 x 100 mm



12 x 12 mm
Art. 1321/5
 100 x 100 mm



12 x 12 mm
Art. 1321/9
 100 x 100 mm



Art. 1411/7
 thickn.-spess.
 5 mm
 H 100 mm
 L 100 mm



Art. 1411/8
 thickn.-spess.
 5 mm
 H 115 mm
 L 187 mm



125 x 125 mm
Art. 1321/2
 100 x 100 mm
Art. 1321/4
 125 x 125 mm

125 x 125 mm
Art. 1321/6
 100 x 100 mm
Art. 1321/8
 125 x 125 mm

125 x 125 mm
Art. 1321/10
 100 x 100 mm
Art. 1321/12
 125 x 125 mm

Galvanized and painted
Zincate e verniciate

Raw
Grezzo

Raw
Grezzo

Raw
Grezzo

Raw
Grezzo



| | Stamped Coniato | Stamped Coniato | Plain Liscio | Plain Liscio | Plain Liscio | Plain Liscio |
|---|--------------------|--------------------|-----------------|------------------|-----------------|-----------------|
| | H 120 mm | H 200 ÷ 250 mm | H 200 ÷ 250 mm | 130 x 170 x 6 mm | 55 x 80 x 3 mm | 40 x 80 mm |
| | Art. | Art. | Art. | Art. | Art. | Art. |
| 1 | 171/1 | 1414/1 | 1414/12 | - | - | *851/1 |
| 2 | 171/2 | 1414/2 | 1414/13 | - | - | *851/2 |
| 3 | 171/3 | 1414/3 | 1414/14 | - | - | *851/3 |
| 4 | 171/4 | 1414/4 | 1414/15 | - | - | *851/4 |
| 5 | 171/5 | 1414/5 | 1414/16 | - | - | *851/5 |
| 6 | 171/6 | 1414/6 | 1414/17 | - | - | *851/6 |
| 7 | 171/7 | 1414/7 | 1414/18 | - | - | *851/7 |
| 8 | 171/8 | 1414/8 | 1414/19 | - | - | *851/8 |
| 9 | 171/9 | 1414/9 | 1414/20 | - | - | *851/9 |
| 0 | 171/10 | 1414/10 | 1414/21 | - | - | *851/10 |
| A | 171/11 | 1412/1 | 1413/1 | 850/1 | *850/27 | - |
| B | 171/12 | 1412/2 | 1413/2 | 850/2 | *850/28 | - |
| C | 171/13 | 1412/3 | 1413/3 | 850/3 | *850/29 | - |
| D | 171/14 | 1412/4 | 1413/4 | 850/4 | *850/30 | - |
| E | - | 1412/5 | 1413/5 | 850/5 | *850/31 | - |
| F | - | 1412/6 | 1413/6 | 850/6 | *850/32 | - |
| G | - | 1412/7 | 1413/7 | 850/7 | *850/33 | - |
| H | - | 1412/8 | 1413/8 | 850/8 | *850/34 | - |
| I | - | 1412/9 | 1413/9 | 850/9 | *850/35 | - |
| J | - | 1412/10 | 1413/10 | 850/24 | *850/50 | - |
| K | - | 1412/11 | 1413/11 | 850/10 | *850/36 | - |
| L | - | 1412/12 | 1413/12 | 850/11 | *850/37 | - |
| M | - | 1412/13 | 1413/13 | 850/12 | *850/38 | - |
| N | - | 1412/14 | 1413/14 | 850/13 | *850/39 | - |
| O | - | 1412/15 | 1413/15 | 850/14 | *850/40 | - |
| P | - | 1412/16 | 1413/16 | 850/15 | *850/41 | - |
| Q | - | 1412/17 | 1413/17 | 850/16 | *850/42 | - |
| R | - | 1412/18 | 1413/18 | 850/17 | *850/43 | - |
| S | - | 1412/19 | 1413/19 | 850/18 | *850/44 | - |
| T | - | 1412/20 | 1413/20 | 850/19 | *850/45 | - |
| U | - | 1412/21 | 1413/21 | 850/20 | *850/46 | - |
| V | - | 1412/22 | 1413/22 | 850/21 | *850/47 | - |
| W | - | 1412/23 | 1413/23 | 850/22 | *850/48 | - |
| X | - | 1412/24 | 1413/24 | 850/25 | *850/51 | - |
| Y | - | 1412/25 | 1413/25 | 850/26 | *850/52 | - |
| Z | - | 1412/26 | 1413/26 | 850/23 | *850/49 | - |

* Letter and number can be matched with the frame of items from no. 851/12 to 851/18

* Lettera e numero abbinabili alla cornice dall'art. 851/12 all'art.851/18

FRAMES FOR NUMBERS AND LETTERS - CORNICI PORTA NUMERI E LETTERE



* Art. 851/12
143 x 186 mm
for one number
per un numero

* Art. 851/14
169 x 302 mm
up to 5 numbers
fino a 5 numeri

* Art. 851/15
169 x 392 mm
up to 7 numbers
fino a 7 numeri



Art. 851/11
80 x 40 mm



* Art. 851/16
145 x 193 mm
up to 3 numbers
fino a 3 numeri

* Art. 851/17
145 x 273 mm
up to 5 numbers
fino a 5 numeri

* Art. 851/18
151 x 353 mm
up to 7 numbers
fino a 7 numeri

example - esempio



Art. 852/1
∅ 12 mm
H 290 mm
L 230 mm



Art. 852/2
∅ 12 mm
H 240 mm
L 180 mm



Art. 1412/27
stamped
coniato
Art. 1413/27
plain - liscio



H 220 x L 170 mm

Art. 1412/28
stamped
coniato
Art. 1413/28
plain - liscio



Art. 1414/22
plain - liscio

H 315 x L 245 mm

H 250 x L 250 mm



Art. 199/1
∅ 3 mm
25 x 25 mm



Art. 199/2
∅ 3 mm
120 x 120 mm



Art. 199/3
∅ 3 mm
60 x 160 mm



Art. 199/4
∅ 3 mm
60 x 160 mm



Art. 199/5
∅ 3 mm
120 x 160 mm



Art. 199/6
∅ 3 mm
150 x 230 mm



Art. 199/12
collars for
fasciette per



Art. 199/7
∅ 3 mm
30 x 70 mm

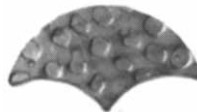

Art. 199/8
∅ 3 mm
80 x 70 mm



Art. 199/10
collars
fascette



Art. 199/11
∅ 3 mm
45 x 25 mm



Art. 199/13
∅ 3 mm
40 x 105 mm



Art. 199/14
∅ 3 mm
40 x 105 mm



Art. 199/9
collars
fascette



Art. 199/15
∅ 3 mm
80 x 105 mm



Art. 199/16
∅ 3 mm
75 x 230 mm



Art. 199/17
∅ 3 mm
75 x 230 mm



MARKETING SUPPORT ASSISTENZA MARKETING

Our marketing department is available to organise promotional activities and develop customised advertising materials bearing the customer's logo. We have many years' experience in producing custom leaflets and catalogues for our most loyal customers.

Il nostro ufficio marketing è a disposizione per organizzare attività ed elaborare materiale promozionale personalizzato con il logo del cliente. Da anni ormai realizziamo volantini e cataloghi ad hoc per i nostri clienti più affezionati.

+39 0445 580 580

from Monday to Friday
dal Lunedì al Venerdì
08.00 -18.00 (GMT+1)

info@arteferro.com

www.arteferro.com

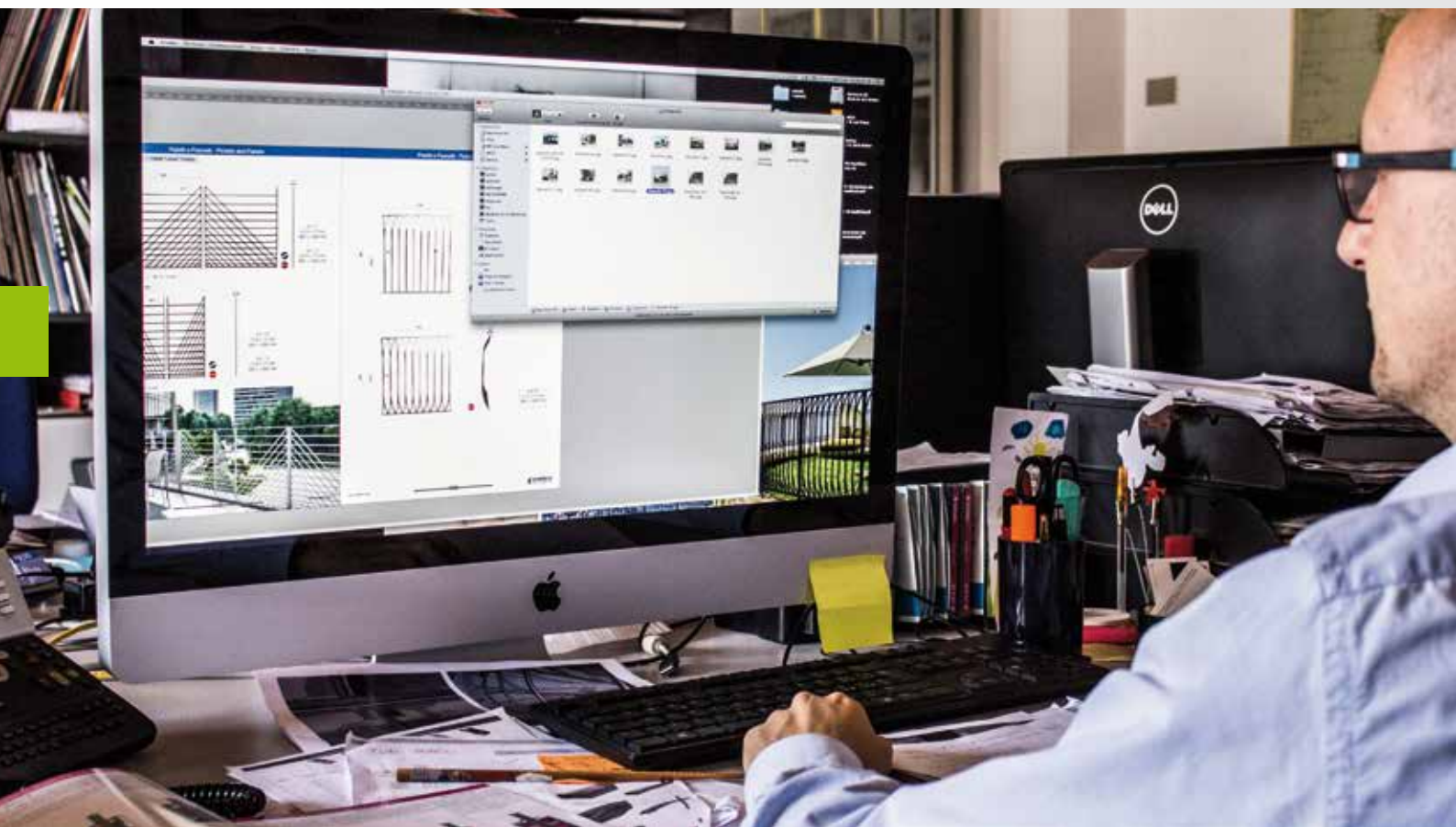



Arteferro plates are decorative elements that can either be positioned at the base or alongside posts, and can be manufactured with a rounded or square shape, depending on the client's aesthetic requirements. Arteferro accessories are mainly complementary elements and have no structural function, such as: handles, knobs, hinges and locks.

Le piastre Arteferro sono elementi decorativi poste o alla base o a lato dei montanti e possono essere realizzate di forma tonda o quadrata a seconda delle esigenze estetiche della committenza. Gli accessori Arteferro invece sono principalmente elementi di complemento e non hanno funzione strutturale, quali: maniglie, pomolini, cardini e serrature.

PIASTRE ED ACCESSORI PLATES AND ACCESSORIES

17

Plates and Accessories
Piastre ed Accessori



17.A Anchor plates Piastre di ancoraggiopag.244
 17.B Rivets Ribattini pag.248
 17.C Chains Catene pag.249
 17.D Door handles Manigliepag.250

17.E Locks covers Copriserratura pag.253
 17.F Locks Serrature pag.254
 17.G Hinges Cardini pag.255
 17.H Paints and varnishes Patine e Vernici pag.257
 17.I Weathervanes and Mail boxes Segnavento e Casette postali pag.258

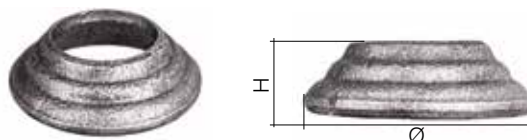
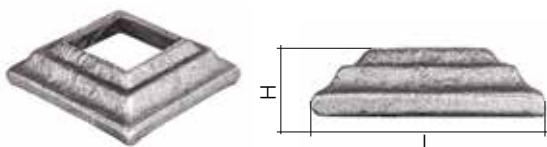

| L/H | Hole - Foro | Art. |
|-------------------------|------------------------------------|--------|
| L 40 x 40 mm H 17 mm | without hole - senza foro | 819/11 |
| | for - per \varnothing 12 x 12 mm | 819/8 |
| | for - per \varnothing 14 x 14 mm | 819/7 |
| | for - per \varnothing 16 x 16 mm | 819/6 |
| L 50 x 50 mm H 19 mm | without hole - senza foro | 819/10 |
| | for - per \varnothing 16 x 16 mm | 819/5 |
| | for - per \varnothing 18 x 18 mm | 819/4 |
| | for - per \varnothing 20 x 20 mm | 819/3 |
| L 60 x 60 mm H 19 mm | without hole - senza foro | 819/9 |
| | for - per \varnothing 25 x 25 mm | 819/2 |
| | for - per \varnothing 30 x 30 mm | 819/1 |
| L 80 x 80 mm H 22 mm | without hole - senza foro | 819/17 |
| | for - per \varnothing 25 x 25 mm | 819/18 |
| | for - per \varnothing 30 x 30 mm | 819/15 |
| | for - per \varnothing 40 x 40 mm | 819/16 |

| Ø/H | Hole - Foro | Art. |
|----------------------|---------------------------|---------|
| Ø 30 mm H 17 mm | without hole - senza foro | 1408/18 |
| | per Ø 12 mm | 1408/21 |
| Ø 40 mm H 18,5 mm | without hole - senza foro | 1408/17 |
| | for - per Ø 12 mm | 1408/5 |
| | for - per Ø 14 mm | 1408/19 |
| Ø 50 mm H 18 mm | for - per Ø 16 mm | 1408/20 |
| | without hole - senza foro | 1408/16 |
| | for - per Ø 16 mm | 1408/13 |
| Ø 60 mm H 18 mm | for - per Ø 18 mm | 1408/12 |
| | for - per Ø 20 mm | 1408/11 |
| | without hole - senza foro | 1408/15 |
| Ø 80 mm H 19 mm | for - per Ø 25 mm | 1408/7 |
| | for - per Ø 30 mm | 1408/6 |
| | without hole - senza foro | 1408/14 |
| Ø 80 mm H 19 mm | for - per Ø 30 mm | 1408/10 |
| | for - per Ø 35 mm | 1408/9 |
| | for - per Ø 40 mm | 1408/8 |

ROUNDED BASES
BASI BOMBATE

BORDERED FLAT BASES
BASI PIANE BORDATE

LENS BASES
BASI ALENTE



Art. 1860/1
Ø 580 mm
H 45 mm
∇ 6 mm

Art. 1860/2
Ø 680 mm
H 50 mm
∇ 8 mm

Art. 1860/3
Ø 780 mm
H 55 mm
∇ 8 mm

Art. 1860/4
Ø 360 mm
H 31,5 mm
∇ 3 mm

Art. 1860/5
Ø 415 mm
H 33 mm
∇ 4 mm

Art. 1860/6
Ø 414 mm
H 44 mm
∇ 4 mm



| Art. | Ø | H | Thickness Spessore |
|--------|--------|-------|--------------------|
| 1861/1 | 170 mm | 20 mm | 3 mm |
| 1861/2 | 200 mm | 25 mm | 4 mm |
| 1861/3 | 220 mm | 32 mm | 4 mm |
| 1861/4 | 240 mm | 25 mm | 6 mm |
| 1861/5 | 260 mm | 28 mm | 6 mm |
| 1861/6 | 290 mm | 31 mm | 6 mm |
| 1861/7 | 320 mm | 32 mm | 6 mm |
| 1861/8 | 370 mm | 38 mm | 5 mm |
| 1861/9 | 500 mm | 28 mm | 5 mm |



| Art. | Ø | H | Thickness Spessore |
|-----------|--------|-------|--------------------|
| 1861/10 | 120 mm | 13 mm | 3 mm |
| 1861/11 | 140 mm | 13 mm | 3 mm |
| 1861/12 | 160 mm | 16 mm | 4 mm |
| 1861/13 | 185 mm | 21 mm | 3 mm |
| 1861/14 | 195 mm | 20 mm | 4 mm |
| 1861/16/S | 275 mm | 30 mm | 6 mm |
| 1861/17 | 295 mm | 40 mm | 6 mm |
| 1861/18 | 340 mm | 35 mm | 6 mm |
| 1861/19 | 380 mm | 35 mm | 6 mm |
| 1861/20 | 480 mm | 40 mm | 6 mm |

BORDERED SQUARE BASES
BASI QUADRATE BORDATE



| Art. | Side Lato | H | Thickness Spessore |
|---------|-----------|-------|--------------------|
| 1861/21 | 143 mm | 14 mm | 6 mm |
| 1861/22 | 200 mm | 19 mm | 6 mm |

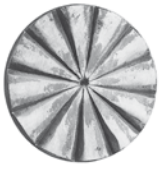

Art. 654/5
Ø 60 mm
⊘ 6 mm



Art. 1393/7
Ø 68 mm
hole - foro
Ø 12,5 mm
⊘ 10 mm



Art. 1857/13
Ø 82 mm
⊘ 4 mm



Art. 1857/14
Ø 82 mm
hole - foro
Ø 8,5 mm
⊘ 4 mm



Art. 1857/15
Ø 82 mm
hole - foro
Ø 15 mm ⊘ 4 mm
H 10 mm



Art. 660/11
Ø 90 mm
⊘ 4 mm



Art. 660/12
Ø 90 mm
⊘ 4 mm



Art. 660/10
Ø 115 mm
⊘ 4 mm

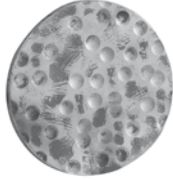

Art. 1408/3
Ø 160 mm
⊘ 10 mm



Art. 116/A/1
70 x 70 mm
Hole - Foro
⊘ 13 x 13 mm
⊘ 5 mm



Art. 802/5
70 x 70 mm
⊘ 6 mm



Art. 116/A/2
75 x 75 mm
hole - foro
⊘ 13 x 13 mm
⊘ 5 mm



Art. 1408/1
80 x 80 mm
hole - foro
⊘ 26 x 26 mm
H 18 mm



Art. 116/A/6
100 x 100 mm
without hole
senza foro
⊘ 10 mm



Art. 116/A/7
100 x 100 mm
hole - foro
⊘ 30 x 30 mm
⊘ 10 mm



Art. 1857/5
100 x 100 mm
⊘ 8 mm
Art. 1857/6
120 x 120 mm
⊘ 8 mm



Art. 1857/7
100 x 100 mm
⊘ 8 mm
Art. 1857/8
120 x 120 mm
⊘ 8 mm



Art. 802/4
100 x 100 mm
⊘ 10 mm



Art. 181/6
120 x 120 mm
⊘ 8 mm

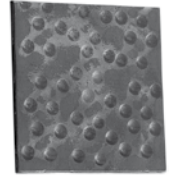

Art. 1408/4
160 x 160 mm
⊘ 10 mm



Art. NEW0049
⊘ 6 mm
H 280 mm
L 130 mm

Art. NEW0050
⊘ 6 mm
H 220 mm
L 100 mm



Art. NEW0054
Base 35 mm
⊘ 6 mm
H 140 mm
L 130 mm

Art. NEW0055
Base 32 mm
⊘ 6 mm
H 110 mm
L 100 mm



Art. 94/A/7
H 165 mm
L 100 mm
Art. 94/A/8
H 150 mm
L 85 mm



Art. 1470/9
H 220 mm
L 75 mm
⊘ 3 mm



Art. 1470/8
H 300 mm
L 75 mm
⊘ 3 mm
Art. 841/7
H 520 mm
L 75 mm
⊘ 3 mm

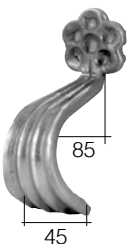

Art. 1857/2
⊘ 8 mm



Art. 1857/4
⊘ 8 mm

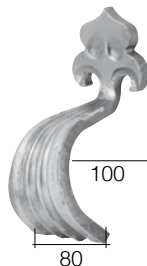

Art. 1857/3
⊘ 8 mm



NEW0051
⊘ 8 mm
80 x 235 mm



NEW0052
⊘ 8 mm
65 x 220 mm



Art. F060
 Ø 33 x 4 mm
 Art. F061
 Ø 42 x 4 mm
 Art. F062
 Ø 48 x 4 mm
 Art. F063
 Ø 60 x 4 mm
 Art. F0631
 Ø 70 x 6 mm
 Art. F064
 Ø 80 x 4 mm
 Art. F065
 Ø 100 x 4 mm
 Art. F066
 Ø 100 x 6 mm
 Art. F069
 Ø 120 x 6 mm

Art. F06910
 Ø 70 x 6 mm
 Art. F06911
 Ø 80 x 6 mm
 Art. F06912
 Ø 100 x 8 mm
 Art. F06913
 Ø 120 x 8 mm

Art. F06920
 Ø 70 x 6 mm
 Art. F06921
 Ø 80 x 6 mm
 Art. F06922
 Ø 100 x 8 mm
 Art. F06923
 Ø 120 x 8 mm

Art. F0681
 Ø 80 x 6 mm
 Art. F0682
 Ø 100 x 6 mm

Art. F0181
 Ø 62 mm
 H 15 mm

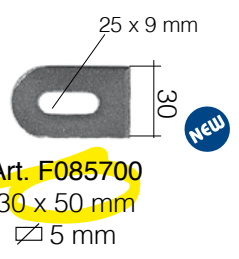

Art. F085700
 30 x 50 mm
 5 mm

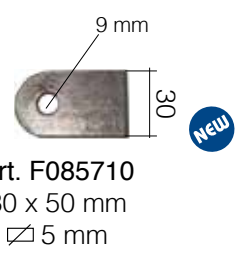

Art. F085710
 30 x 50 mm
 5 mm



Art. F085720
 30 x 38 mm
 5 mm

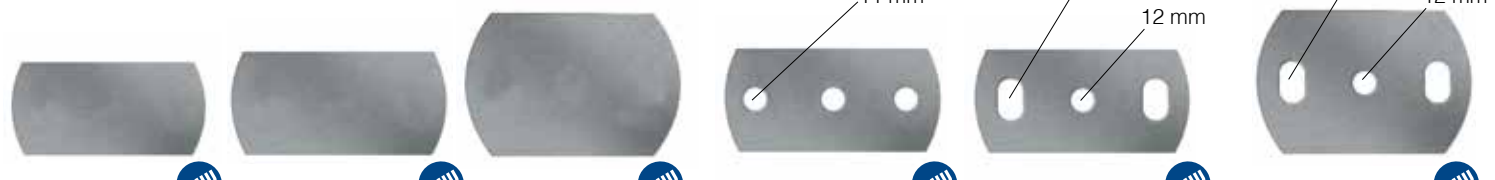

Art. F083500
 50 x 100 mm
 8 mm

Art. F083510
 60 x 120 mm
 8 mm

Art. F083520
 80 x 120 mm
 8 mm

Art. F083600
 50 x 100 mm
 8 mm

Art. F083610
 60 x 120 mm
 8 mm

Art. F083620
 120 x 80 mm
 8 mm



Art. F085500
 100 x 100 mm
 6 mm



Art. F085600
 100 x 100 mm
 6 mm

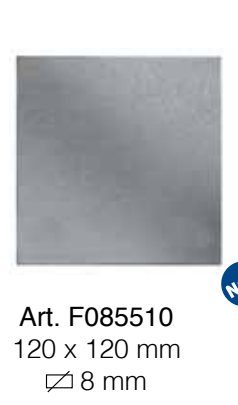

Art. F085510
 120 x 120 mm
 8 mm



Art. F085610
 120 x 120 mm
 8 mm



Art. F0222

NEW

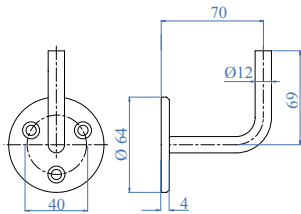

Art. F02231

NEW

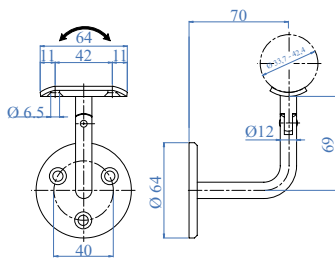

Art. F0223

NEW

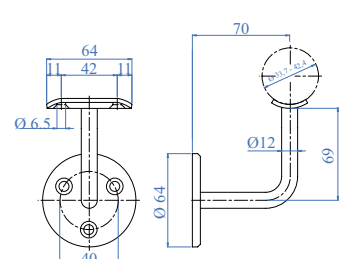

NEW

Art. F01197

25 x 64 mm
for tube - per tubo
Ø 33,7 - Ø 42,4 mm
∇ 4 mm



NEW

Art. F011976

25 x 64 mm
flat surf. - sup. piana
∇ 4 mm



NEW

Art. F011974

for tube - per tubo
Ø 33,7 - Ø 42,4 mm
∇ 4 mm



NEW

Art. F011971

for tube - per tubo
Ø 33,7 - Ø 42,4 mm
∇ 4 mm

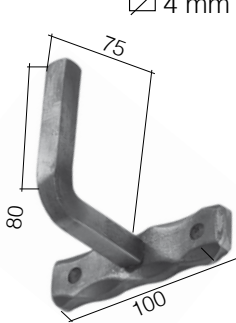

Art. 1405/1

Base 25 x 8 mm
holes-foi Ø 8,5 mm
∅ 12 x 12 mm

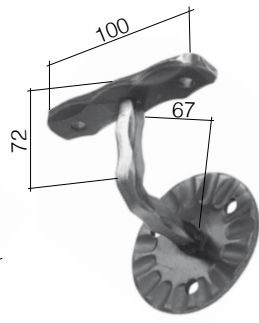

Art. 1405/2

Base Ø 80 x 4 mm
holes-foi Ø 8,5 mm
∅ 12 x 12 mm

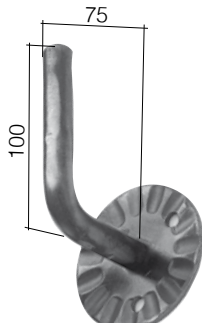

Art. 1405/3

Base Ø 80 x 4 mm
holes-foi Ø 8,5 mm
Ø 16 mm



Art. 94/A/1

90 x 160 mm



Art. 94/A/2

90 x 160 mm



Art. 116/33

16 x 16 mm
H 110 mm
L 150 mm
lathed-tornito Ø 14 mm

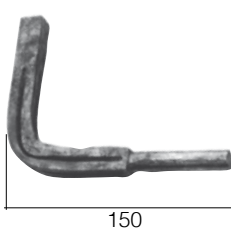

Art. 116/34

16 x 16 mm
H 110 mm
L 150 mm
lathed-tornito Ø 14 mm



Art. 116/35

Ø 65 mm
∇ 8 mm
hole - foro Ø 15 mm

Rivets - Ribattini

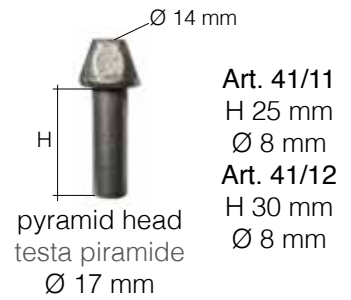
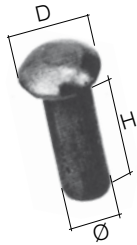

| Art. | Ø | H | D |
|-------|------|-------|-------|
| 41/17 | 6 mm | 20 mm | 11 mm |
| 41/18 | 6 mm | 25 mm | 11 mm |
| 41/19 | 6 mm | 30 mm | 11 mm |
| 41/20 | 6 mm | 35 mm | 11 mm |
| 41/21 | 6 mm | 40 mm | 11 mm |
| 41/22 | 6 mm | 45 mm | 11 mm |
| 41/23 | 6 mm | 50 mm | 11 mm |
| 41/24 | 6 mm | 60 mm | 11 mm |
| 41/13 | 7 mm | 25 mm | 11 mm |
| 41/14 | 8 mm | 8 mm | 16 mm |
| 41/15 | 8 mm | 20 mm | 16 mm |
| 41/1 | 8 mm | 25 mm | 16 mm |
| 41/4 | 8 mm | 30 mm | 16 mm |
| 41/5 | 8 mm | 35 mm | 16 mm |
| 41/6 | 8 mm | 40 mm | 16 mm |
| 41/16 | 8 mm | 45 mm | 16 mm |
| 41/7 | 8 mm | 50 mm | 16 mm |
| 41/8 | 8 mm | 60 mm | 16 mm |

ORNAMENTAL RIVETS
CHIODI ORNAMENTALI



STUDS
BROCCHIE DI COPERTURA



These items appeared scenes of the film "Sangue Del Tuo Sangue" (2015) by Marco Bellocchio, which was shown at the 72nd Venice International Film Festival.
Questi articoli compaiono nelle scene del film Sangue del tuo sangue (2015) di Marco Bellocchio, presentato alla 72° Mostra Internazionale del Cinema di Venezia.



FORGED RIVETS
CHIODI FORGIATI



| Art. | Head Testa | Shank Sotto testa \square | H |
|---------|------------|-----------------------------|----------|
| 1474/6 | 30 mm | 14 x 14 mm | L 285 mm |
| 1474/7 | 30 mm | 12 x 12 mm | L 210 mm |
| 1474/8 | 25 mm | 10 x 10 mm | L 160 mm |
| 1474/9 | 20 mm | 8 x 8 mm | L 105 mm |
| 1474/10 | 13 mm | 5 x 5 mm | L 70 mm |

RIVET HEADS TO BE WELDED
TESTE DI RIBATTINI TORNITE A SALDARE



SELF-TAPPING SCREWS - VITI AUTOFILETTANTI
forged head - testa forgiata



| Art. | Head Testa \square | Thread MA Filetto MA | H |
|-------|----------------------|----------------------|-------|
| 695/6 | 30 x 30 mm | 10 mm | 90 mm |
| 695/7 | 22 x 22 mm | 8 mm | 75 mm |
| 695/8 | 16 x 16 mm | 8 mm | 62 mm |

| Art. | Head Testa | Thread MA Filetto MA | H |
|--------|------------|----------------------|-------|
| 695/9 | Ø 35 mm | 10 mm | 90 mm |
| 695/10 | Ø 24 mm | 8 mm | 85 mm |
| 695/11 | Ø 18 mm | 8 mm | 62 mm |

| Art. | Diameter Diametro | Hole Foro |
|-------|-------------------|-----------|
| 697/5 | Ø 16 mm | Ø 8 mm |
| 697/7 | Ø 12 mm | Ø 6 mm |
| 697/8 | Ø 12 mm | Ø 5 mm |

Length of the chains
Lunghezza delle catene
= 10.000 mm (10 mt.)



Not all of the Arterferro items are available in **Arterferro Quick**, just a special selection. Find out about the entire range in the catalogue

In **Arterferro Quick** non sono presenti tutti gli articoli Arterferro, ma solo una speciale selezione. Scopri la gamma completa nel catalogo

Compendium



Art. 156/A/7
5 x 5 mm

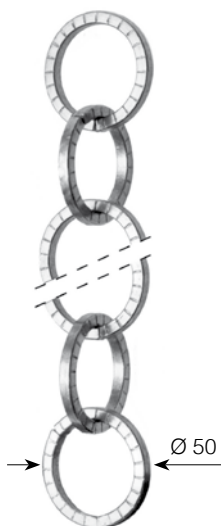

Art. 156/A/8
5 x 5 mm



Art. 156/A/10
5 x 5 mm



Art. 156/A/11
3,5 x 3,5 mm

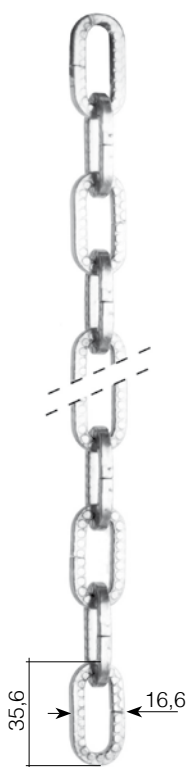

Art. 156/A/12
3,8 x 3,8 mm





Art. 168/4
250 x 38 mm
(couple-coppia)



Art. 168/6
250 x 56 mm
(couple-coppia)



Art. 168/5
265 x 48 mm
(couple-coppia)



Art. 168/3
265 x 48 mm
(couple-coppia)



Art. 833/4
280 x 60 mm
(couple-coppia)



Art. 836/1
250 x 50 mm
(couple-coppia)



Art. 831/1
255 x 55 mm
(couple-coppia)



Art. 169/12
70 x 135 mm
(couple-coppia)



Art. 835/6
Rosetta Ø 30 mm
(couple-coppia)



Art. 169/13
80 x 140 mm
(couple-coppia)



Art. 835/8
90 x 50 mm
(couple-coppia)



Art. 835/7
90 x 50 mm
(couple-coppia)



Art. 835/9
100 x 40 mm
(couple-coppia)



Art. 169/15
40 x 110 mm
(couple-coppia)

handle complete with rosette
maniglia completa di rosetta



Art. 169/14 **BEST PRICE**
70 x 135 mm
(couple-coppia)

handle complete with rosette
maniglia completa di rosetta



Art. 169/11
70 x 125 mm
(couple-coppia)

handle complete with rosette
maniglia completa di rosetta

TOPS - POMOLI

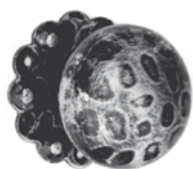

Art. 169/1
Ø 68 mm
rotating-girevole
(couple-coppia)

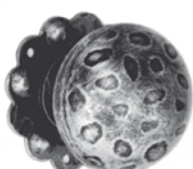

Art. 169/2
Ø 60 mm
fixed-fisso



Art. 169/3
Ø 60 mm
rotating-girevole
(couple-coppia)



Art. 834/1
Ø 67 mm
H 75 mm
rotating-girevole
(couple-coppia)



Art. 838/1
57 x 57 mm
H 70 mm
rotating-girevole
(couple-coppia)
Art. 838/2
57 x 57 mm
H 70 mm
fixed-fisso

TOPS - POMOLI



Art. 838/3
60 x 60 mm
H 45 mm
fixed-fisso



Art. 838/4
75 x 75 mm
H 60 mm
fixed-fisso



Art. 1474/5
Ø 70 mm
Ø 8MA
thread hole-foro filetto



Even today, most
of the accessories
are produced manually
just like they were in 1971

Ancora oggi
la gran parte degli
accessori vengono
prodotti manualmente
come nel 1971



Art. 833/3
77 x 35 mm
(couple-coppia)



Art. 833/2
Ø 53 mm
(couple-coppia)



Art. 833/1
58 x 58 mm
(couple-coppia)



Art. 1475/7
37 x 75 mm
Plain-Liscio



Art. 833/6
240 x 260 mm
(couple-coppia)



Art. 834/3
265 x 80 mm
(couple-coppia)



Art. 836/4
275 x 60 mm
rotating-girevole

**MECHANISM GRAZ FOR CREMONESI HANDLES
GIOCHI GRAZ PER CREMONESI**

Art. 835/1
200 x 40 mm
built-in - incasso



Art. 835/2
160 x 55 mm
built-in - incasso



Art. 835/3
150 x 45 mm
built-in - incasso



Art. 835/4
140 x 33 mm
backed - ridosso



Art. 835/5
190 x 35 mm
built-in - incasso

KNOBS - BATTENTI

Art. 837/2
Ø 150 mm
rosette - rosetta
Ø 80 mm



Art. 1474/4
Ø 120 mm
base Ø 90 mm



Art. 1474/4
Ø 110 mm
rosette - rosetta
Ø 95 mm



Art. 170/A/5
49 x 43 mm



Art. 170/7
170 x 105 mm



Art. 837/3
Ø 100 mm
rosette - rosetta
Ø 60 mm

FIXED HANDLES - MANIGLIONI FISSI

Art. 839/3
480 x 80 mm
□ 18 mm



Art. 1474/3
315 x 40 mm



Art. 839/4
250 x 70 mm
□ 18 mm



Art. 170/6
310 x 60 mm



Art. 839/1
H 300 mm
Ø 32 mm
rosette - rosetta
Ø 80 mm



Art. 1474/2
H 340 mm
rosette - rosettes
Ø 90 mm



Art. 1474/1
270 x 55 mm

Art. 839/2
H 200 mm
Ø 25 mm
rosette - rosetta
Ø 60 mm





Art. 170/A/10
49 x 43 mm



Art. 170/A/6
90 x 33 mm



Art. 170/A/4
90 x 38 mm



Art. 170/A/8
58 x 27 mm



Art. 170/A/11
58 x 27 mm



Art. 170/A/1
31 x 121 mm



Art. 170/A/7
48 x 48 mm



Art. 170/A/9
48 x 48 mm



Art. 834/2
Ø 67 mm



Art. 170/1
Ø 65 mm



Art. 170/2
Ø 65 mm



Art. 170/3
Ø 50 mm



Art. 170/5
Ø 50 mm



Art. 839/5
85 x 35 mm
∇ 2 mm



Art. 839/6
85 x 35 mm
∇ 2 mm



Art. 839/7
85 x 35 mm
spess. 2 mm
hole-foro Ø 14 mm



Art. 839/8
70 x 35 mm
∇ 2 mm



Art. 839/9
100 x 40 mm
∇ 2 mm



Art. 839/10
100 x 40 mm
spess. 2 mm
hole-foro Ø 14 mm



Art. 169/6
250 x 56 mm



Art. 169/7
250 x 38 mm



Art. 169/8
265 x 48 mm



Art. 169/9
265 x 48 mm



Art. 169/10
250 x 38 mm



Art. 169/4
40 x 250 mm



Art. 169/5

Locks - Serrature

Art. 181/10
285 x 105 mm
☒ 30 mm

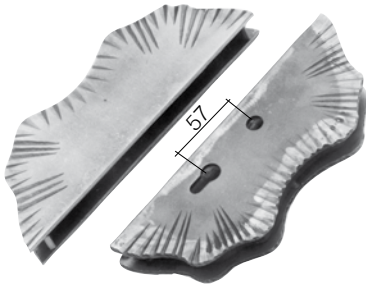

Art. 181/11
285 x 105 mm
☒ 30 mm

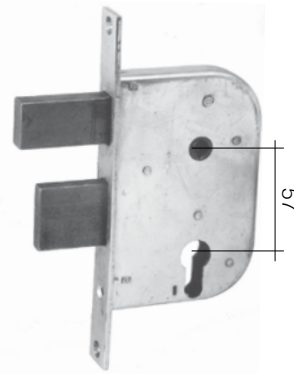

Art. 181/12
Double-lock latch
Serratura doppia mandata

YALE LOCKS
BLOCCETTI YALE



Art. 181/15

BOLTS - CATENACCI



Art. 170/B/1
45 x 190 mm



Art. 170/B/2
30 x 150 mm



Art. 170/B/3
30 x 105 mm



Art. 170/B/5
81 x 137 mm



Art. 840/4
30 x 160 mm



Art. 840/5
30 x 200 mm



Art. 840/6
50 x 150 mm



Art. 840/1
65 x 300 mm



Art. 840/2
65 x 350 mm



Art. 840/3
65 x 400 mm



Art. 182/1
60 x 100 mm



Art. 182/2
60 x 280 mm



Hinges - Cardini

power hammered
magliato

plain
liscio

power hammered
magliato



Art. 170/B/4
Ø 14 mm
H 100 mm
thread - filetto
8MA mm



Art. 830/1
Ø 22 mm
H 100 mm
thread - filetto
14MA mm



Art. 830/2
Ø 22 mm
H 100 mm
thread - filetto
14MA mm



Art. 181/13
Ø 38 mm
H 230 mm
thread - filetto
22MA mm
Art. 181/14
Ø 32 mm
H 175 mm
thread - filetto
18MA mm

Welding hinge
Cardine a saldare



Art. 164/1
thread - filetto
18MA mm
Art. 164/2
thread - filetto
22MA
Art. 830/17
thread - filetto
27MA mm

Wall hinge
Cardine a muro



Art. 164/3
thread - filetto
18MA mm
Art. 164/4
thread - filetto
22MA
Art. 830/18
thread - filetto
27MA mm



Hinge with orthogonal regulation
opening of up to 180°
Cardine a regolazione ortogonale
con apertura fino a 180°

Art. 830/19
thread - filetto
18MA mm
Art. 830/20
thread - filetto
22MA mm
Art. 830/21
thread - filetto
27MA mm

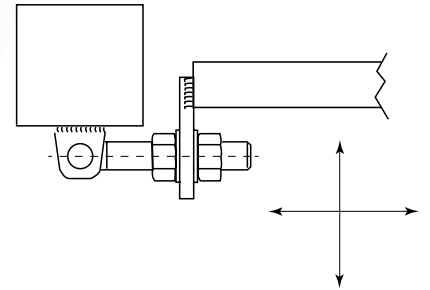

Passing hinge
Cardine passante



Art. 830/3
thread - filetto
20MA mm



Art. 164/5
thread - filetto
18MA mm
Art. 164/6
thread - filetto
22MA mm



Art. 830/7
H 89 mm - Ø 28 mm

Art. 830/9
H 89 mm - Ø 23 mm

Art. 830/10
H 89 mm - Ø 28 mm

Pivot
Perno



With hinge
Con cardine
18MA
Art. 164/7
to be coupled with
da abbinare con
art. 164/9

With hinge
Con cardine
22MA
Art. 164/8
to be coupled with
da abbinare con
art. 164/10

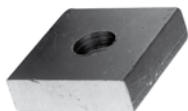

Art. 830/13
H 20 mm - L 80 mm

Art. 830/15
H 20 mm - L 70 mm

Art. 830/16
H 20 mm - L 80 mm

Plate
Piastra

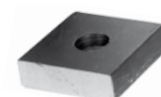

With hinge
Con cardine
18MA
Art. 164/9
With hinge
Con cardine
22MA
Art. 164/10

LATCHES/LIGHT HINGES FOR FURNITURE
CATENACCI/CERNIERE LEGGERI PER MOBILI



Art. 837/4
H 145 mm
60 x 2 mm



Art. 837/5
H 260 mm
55 x 2 mm



Art. 837/7
H 95 mm
70 x 2 mm



Art. 837/9
H 145 mm
110 x 2 mm



Art. 837/8
H 100 mm
70 x 2 mm



Art. 837/10
H 160 mm
120 x 2 mm



Art. 170/A/3
92 x 55 x 2 mm



Art. 170/A/2
68 x 125 x 2 mm

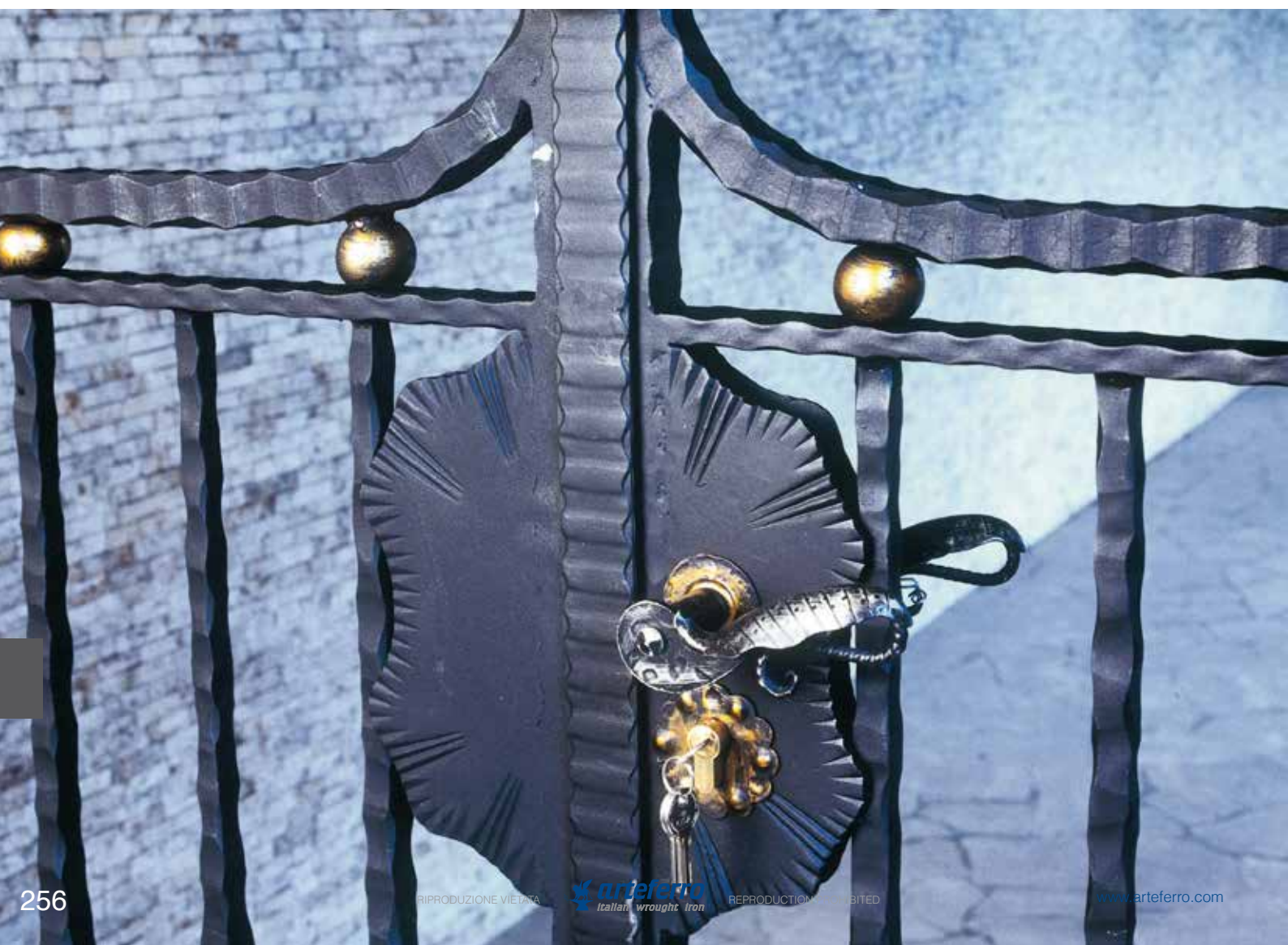

Arteferro supplies paints and patinas for finishing your wrought ironwork, both indoors and outdoors. They can be used to colour handrails, stairs, gates, bars, fences and other decorative elements in forged iron.

Arteferro mette a disposizione vernici e patine per rifinire al meglio le vostre realizzazioni in ferro battuto, sia in interni che in esterni. Possono essere utilizzate per la colorazione di corrimani, scale, cancelli, inferriate, recinzioni ed altri elementi decorativi in ferro forgiato.

Varnishes - Vernici

Arteferro **paints**, available either as transparent varnishes or coloured paints, provide a finishing and at the same time prevent the natural deterioration of metal caused by atmospheric agents. To obtain better and longer lasting results, we recommend you to "prepare" the iron using other Arteferro products such as nitro thinner or an iron brush.

Le **vernici** Arteferro, disponibili sia trasparenti che colorate, rifiniscono e al contempo prevengono il naturale deterioramento del metallo dovuto agli agenti atmosferici. Per ottenere risultati migliori e duraturi consigliamo di "preparare" il ferro utilizzando gli altri prodotti Arteferro come il diluente nitro o la spazzola per ferro.

Patinas - Patine

Arteferro **patinas** are special paints, very opaque and dense, which allow an elegant oxidation effect to be produced on the metal, thus giving the painted product a refined style with a thick decorative finish. Available in gold, copper, silver and green, they can be applied after painting as well as directly onto the iron.

Le **patine** Arteferro sono vernici particolari, molto coprenti e dense, che consentono di riprodurre un elegante effetto ossidazione sul metallo, conferendo così al prodotto verniciato uno stile ricercato di grande spessore decorativo. Disponibili in colore oro, rame, argento e verde possono essere applicate dopo la verniciatura ma anche direttamente sul ferro.



Wrought Iron Black
Nero forgia
Art. 227/1 Lt. 0,75
Art. 227/2 Lt. 2,50



Graphite gray
Grafite
Art. 227/3 Lt. 0,75
Art. 227/4 Lt. 2,50



Dark brown
Testa di moro
Art. 227/35 Lt. 0,75
Art. 227/36 Lt. 2,50



Rust colour coating
Ruggine trasparente
Art. 227/53 Lt. 0,75
Art. 227/54 Lt. 2,50



Black gray
Grigio nero
Art. 227/45 Lt. 0,75
Art. 227/20 Lt. 2,50



Dark gray
Grigio scuro
Art. 227/46 Lt. 0,75
Art. 227/22 Lt. 2,50



Bronze
Bronzo
Art. 227/47 Lt. 0,75
Art. 227/24 Lt. 2,50



English red
Rosso inglese
Art. 227/39 Lt. 0,75
Art. 227/40 Lt. 2,50



Dark green
Verde scuro
Art. 227/55 Lt. 0,75
Art. 227/56 Lt. 2,50



Antique white
Bianco antico
Art. 227/33 Lt. 0,75
Art. 227/34 Lt. 2,50



Pearl grey
Grigio perla
Art. 227/41 Lt. 0,75
Art. 227/42 Lt. 2,50



Art. 227/43
Silver gray
Grigio argento
Art. 227/43 Lt. 0,75
Art. 227/16 Lt. 2,50



Light chiaro
Grigio chiaro
Art. 227/44 Lt. 0,75
Art. 227/18 Lt. 2,50



Green wagon
Verde vagone
Art. 227/37 Lt. 0,75
Art. 227/38 Lt. 2,50



Gold patina
Patina oro
Art. 227/29 Lt. 0,25



Copper patina
Patina rame
Art. 227/30 Lt. 0,25



Green patina
Patina verde
Art. 227/31 Lt. 0,25



Silver patina
Patina argento
Art. 227/32 Lt. 0,25



Thinner
Diluente sintetico
Art. 227/27 Lt. 1,00
Art. 227/28 Lt. 5,00



Pale gold patina
Patina oro pallido
Art. 227/51 Lt. 0,25



Antique gold patina
Patina oro antico
Art. 227/52 Lt. 0,25



Verdigris mat patina
Patina verde rame opaco
Art. 227/30 Lt. 0,25

Nitre thinner
Diluente Nitro
Art. 227/57 Lt. 1,00
Art. 227/58 Lt. 5,00

Weathervanes and Mail boxes - Segnavento e Cassette postali



Art. 10314/1
762 x 762 mm



Art. 10314/2
698 x 965 mm



Art. 10314/3
482 x 673 mm



Art. 10314/4
546 x 546 mm



Art. 10315/1
635 x 508 mm



Art. 10315/2
635 x 546 mm



Art. 10315/3
685 x 698 mm



Art. 10316/1
787 x 571 mm



Art. 10315/6
558 x 520 mm



Art. 10301/2
H 455 mm - L 400 mm
P 155 mm
cast iron
ghisa



Art. 5069/3
H 1100 mm
Base 330 x 240 mm
cast iron - ghisa



Art. 10301/1
H 405 mm - L 255 mm
P 90 mm
cast iron - ghisa



Art. 849/1
Aluminium - White colour
Alluminio - Colore bianco

Art. 849/2
Aluminium - Black colour
Alluminio - Colore bianco

Art. 849/3
Aluminium - Red colour
Alluminio - Colore rosso

Art. 849/4
Aluminium - Green colour
Alluminio - Colore verde





TOOLS

UTENSILI

The fabrication tools include all blacksmith's accessories, such as: anvils, hammers, shapers, templates, forging pliers and much more. With the right tools, installation becomes easier, faster and safer. Arteferro has chosen to make available to its customers a range of tools dedicated to the correct assembly of its semi-finished products.

Gli strumenti fabbrili comprendono tutta l'accessoristica per fabbri quali: incudini, martelli, sagomatori, dime, pinze da forgiatore e molto altro ancora. Con i giusti strumenti l'installazione diventa più facile, più veloce e più sicura. Arteferro ha scelto di mettere a disposizione dei propri clienti una gamma di strumenti dedicati al corretto montaggio dei suoi semilavorati.

Art. 869/1
150 kg



Art. 869/2
H 500 mm
Ø 500 mm

Art. 870/1
50 kg



Art. 870/2
H 580 mm
Ø 350 mm

Art. 870/3
100 kg



Art. 870/4
H 530 mm
Ø 400 mm

ANVIL ENGRAVERS AND SHAPERS - INCISORI E SAGOMATORI PER INCUDINE



| Art. | Ø |
|-------|-------|
| 872/1 | 5 mm |
| 872/2 | 10 mm |
| 872/3 | 20 mm |
| 872/4 | 25 mm |
| 872/5 | 30 mm |



| Art. | Ø |
|--------|-------|
| 872/6 | 5 mm |
| 872/7 | 10 mm |
| 872/8 | 15 mm |
| 872/9 | 20 mm |
| 872/10 | 25 mm |
| 872/11 | 30 mm |



Art. 873/1
Flat shaping engraver
Sagomatore piano



Art. 873/2
Notched engraver
Incisore a tacche



Art. 873/3
Conic engraver
Incisore puntale



Art. 871/1
H 840 mm
L 350 mm
Calibrating template
Dima calibratrice

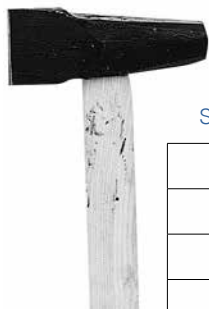

SHAPED CHISELS
SCALPELLI SAGOMATORI

| Art. | Ø |
|-------|-------|
| 876/1 | 5 mm |
| 876/2 | 10 mm |
| 876/3 | 20 mm |
| 876/4 | 25 mm |
| 876/5 | 30 mm |



SQUARE HEAD WEDGE
CACCIA CUNEO A PUNTA QUADRA

| Art. | □ |
|-------|-------|
| 877/1 | 10 mm |
| 877/2 | 15 mm |
| 877/3 | 20 mm |
| 877/4 | 25 mm |



ROUND HEAD WEDGE
CACCIA CUNEO A PUNTA TONDA

| Art. | Ø |
|-------|-------|
| 877/5 | 10 mm |
| 877/6 | 15 mm |
| 877/7 | 20 mm |
| 877/8 | 25 mm |

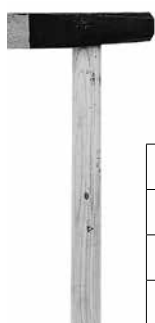

KNIFE CHISELS
SCALPELLI A COLTELLO

| Art. | Peso |
|-------|--------|
| 875/7 | 1,0 Kg |
| 875/8 | 1,5 Kg |
| 875/9 | 2,0 Kg |

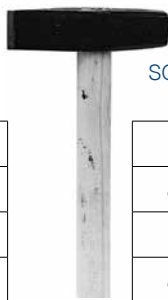

SQUARE HEAD WEDGE CHISELS
SCALPELLI INCISORI

| Art. | Peso |
|--------|--------|
| 875/10 | 1,0 Kg |
| 875/11 | 1,5 Kg |
| 875/12 | 2,0 Kg |



SHAPED CHISELS
SCALPELLI SAGOMATORI

| Art. | Ø |
|--------|-------|
| 876/6 | 5 mm |
| 876/7 | 10 mm |
| 876/8 | 15 mm |
| 876/9 | 20 mm |
| 876/10 | 25 mm |
| 876/11 | 30 mm |

FLAT SHAPING CHISELS
SCALPELLI SAGOMATORI PIANI



Art. 874/4
70 x 70 mm



Art. 874/5
50 x 50 mm



Art. 874/1
1,5 kg



Art. 874/2
1,5 kg



Art. 874/3
2,0 kg

SLEDGEHAMMERS - MAZZE



Art. 875/1
3,0 kg



Art. 875/2
4,0 kg



Art. 875/3
5,0 kg



Art. 875/4
6,0 kg



Art. 875/5
8,0 kg



Art. 875/6
10,0 kg

HOT STAMPED BLACKSMITH'S TONGS TENAGLIE STAMPATE L 500 mm



Art. 878/1



Art. 878/5



Art. 878/2



Art. 878/6

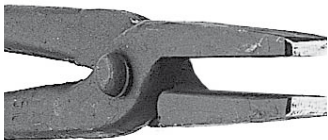

Art. 878/3

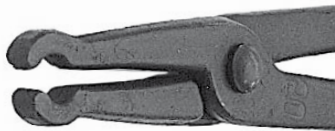

Art. 878/7



Art. 878/4

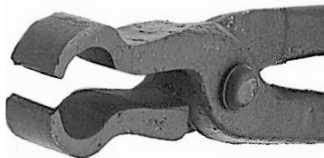

Art. 878/8

FORGING TOOLS TENAGLIE FORGIATE L 450 mm

Art. 879/2



Art. 879/3

SINGLE OVEN - FORNO SINGOLO

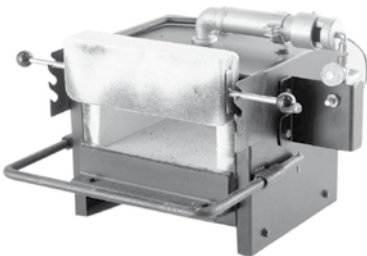

Art. 1559/1

External measures - Misure esterne
L 310 mm - H 255 mm - P 255 mm
Internal measures - Misure interne
L 200 mm - H 250 mm - P 90 mm

SMALL FORGE™ TRANSPORTABLE BY HAND

MAIN FEATURES:

- Maximum Temperature 1300°C
- Easy ignition
- Safety device, in case of any sudden or accidental malfunction
- Opening on two sides (front / back) to insert long bars
- The combustion chamber is isolated with ceramicfiber panels made of refractory material
- The front screen with its adjustable opening, allow for energy saving and guarantees the maximum security



The ovens fulfill
the current international
guidelines of security, in
accordance with the
EC rules

I forni rispondono
alle vigenti direttive
internazionali di
sicurezza, in conformità
alla normativa CE

DOUBLE OVEN - FORNO DOPPIO

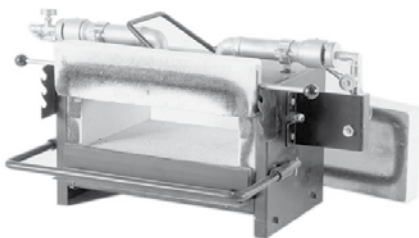

Art. 1559/2

External measures - Misure esterne
L 410 mm - H 255 mm - P 255 mm
Internal measures - Misure interne
L 300 mm - H 250 mm - P 90 mm

PICCOLA "FORGIA" TRASPORTABILE A MANO

CARATTERISTICHE PRINCIPALI:

- Temperatura massima 1300 °C
- Accensione facilitata
- Dispositivo di sicurezza in caso di spegnimento accidentale
- Forno a passaggio totale (avanti / dietro) per l'inserimento anche di verghe lunghe
- La camera di combustione è isolata con pannelli in fibroceramica e base in refrattario
- Lo schermo a chiusura regolabile permette un risparmio di energia e garantisce la massima sicurezza

WORKING GLOVES - GUANTI DA LAVORO



Swine skin
Crosta di Maiale
Art. 880/1



Swine skin
Crosta di Maiale
Art. 880/2



Cotton and latex
Cotone e Lattice
Art. 880/3



Welding gloves-long
Lungo per la saldatura
Art. 880/4



Welding gloves-short
Corto per la saldatura
Art. 880/5

CUT-OFF WHEELS
DISCHI DA TAGLIO

- Art. 881/1
Ø 115 mm
3,40 x 22 mm
Art. 881/2
Ø 230 mm
3,40 x 22 mm
Art. 881/3
Ø 300 mm
3,00 x 22 mm
fix/fissi

GRINDING WHEELS
DISCHI SMERIGLIO

- Art. 881/4
Ø 115 mm
6,00 x 22 mm
Art. 881/5
Ø 230 mm
6,00 x 22 mm

LAMINATED WHEELS
DISCHI LAMELLARI

- Art. 881/6
Ø 115 x 22 mm
grain-grana 40
Art. 881/7
Ø 230 x 22 mm
grain-grana 60
Art. 881/8
Ø 115 x 22 mm
grain-grana 80
Art. 881/9
Ø 115 x 22 mm
grain-grana 120



WELDING ELECTRODES - ELETTRODI PER SALDATURA



| Art. | * 882/1 | * 882/2 | * 882/3 |
|--|----------------------|-----------------------|-----------------------|
| Measurements Misure | Ø 2,5 mm L 300 mm | Ø 3,25 mm L 350 mm | Ø 3,25 mm L 400 mm |
| Boxes per pallet - Scatole sul bancale | 240 | 234 | 160 |
| * Pieces in each box - Pezzi in ogni scatola | 290 | 180 | 157 |
| Weight per pallet - Peso per bancale | 1200 kg | 1200 kg | 1200 kg |

LIQUID ZINC SPRAY
ZINCO LIQUIDO SPRAY
400 ml

Art. 185/9

ANTI SOLDER
WELDING SPRAY
ANTI SPRUZZO DI
SALDATURA
400 ml

Art. 883/1

UNLOCKING SPRAY
SPRAY SBLOCCANTE
400 ml

Art. 883/3

CHEMICAL ANCHOR
(adaptable silicone piston)
ANCORANTE CHIMICO
(adattabili su pistone per silicone)

Art. 883/4

**STAIR MEASUREMENT SYSTEM
SISTEMA MISURAZIONE SCALE**

**Stair
shaper**

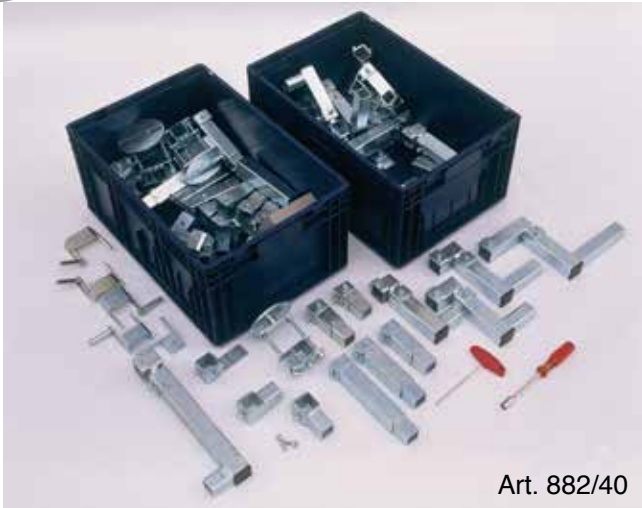

Art. 882/40

Kit with 2 boxes
Total 72 pieces
galvanized
Kit di 2 casse
Totale 72 pezzi
zincati a freddo

Arteferro also supplies Stair Shaper a special system that allows you to measure stairs, even with an irregular form, and to reconstruct the profile at a 1: 1 scale in your workshop. In this way you can work on sizing the staircase easily with all your tools and only need to go back to the construction site for the final installation.

Arteferro fornisce anche Stair Shaper, uno speciale sistema che consente di misurare una scala, anche a sviluppo irregolare, e ricostruirne il profilo in rapporto 1:1 nella propria officina. Potrai quindi comodamente lavorare al dimensionamento della scala con tutti i tuoi attrezzi e recarti nuovamente in cantiere solo per l'installazione finale.

The advantages of the system are:

- it's easy to use
- you can work in the comfort of your workshop
- the time spent on the construction site is reduced
- you can save up to 10 hours of labour for every railing

I vantaggi del sistema:

- facile da usare
- lavori nella comodità della tua officina
- riduci il tempo passato in cantiere
- risparmi fino a 10 ore di manodopera per ogni ringhiera

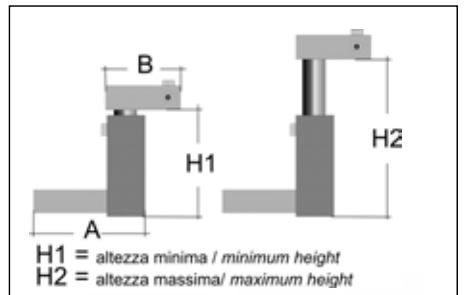

RAISING COMPONENTS OF STEPS - COMPONENTI DI ALZATA

| | | | | | | |
|-------------|-------------|-------------|-------------|-------------|-------------|-------------|
| | | | | | | |
| Art. 1905/1 | Art. 1905/2 | Art. 1905/3 | Art. 1905/4 | Art. 1905/5 | Art. 1905/6 | Art. 1905/7 |
| A = 120 mm | A = 120 mm | A = 210 mm | A = 90 mm | A = 150 mm | A = 90 mm | A = 90 mm |
| B = 55 mm | B = 85 mm | B = 155 mm | B = 55 mm | B = 85 mm | B = 55 mm | B = 55 mm |
| H1 = 160 mm | H1 = 160 mm | H1 = 160 mm | H1 = 160 mm | H1 = 160 mm | H1 = 160 mm | H1 = 310 mm |
| H2 = 235 mm | H2 = 235 mm | H2 = 235 mm | H2 = 235 mm | H2 = 235 mm | H2 = 235 mm | H2 = 500 mm |

TREAD COMPONENTS OF STEPS - COMPONENTI DI PROFONDITÀ PEDATE

| | | | | |
|-------------|-------------|--------------|--------------|--------------|
| | | | | |
| Art. 1905/8 | Art. 1905/9 | Art. 1905/10 | Art. 1905/12 | Art. 1905/13 |
| L 200 mm | L 150 mm | L 100 mm | L 80 mm | L 50 mm |

ELABORATION / SUPPORT / SLIDING COMPONENTS - COMPONENTI DI SVILUPPO/APPOGGIO/SCORRIMENTO

| | | | | | |
|--------------|--------------|---|-------------------------|-------------------------|--------------|
| | | | | | |
| Art. 1905/14 | Art. 1905/15 | Art. 1905/16 | Art. 1905/17 | Art. 1905/18 | Art. 1905/19 |
| | | hole-foro 35 x 35 mm H 100 mm flange-flangia Ø 140 mm | hole-foro 35 x 35 mm | hole-foro 35 x 35 mm | |

Not all of the Arterferro items are available in **Arterferro Quick**, just a special selection.

Find out about the entire range in the catalogue

In **Arterferro Quick** non sono presenti tutti gli articoli Arterferro, ma solo una speciale selezione.

Scopri la gamma completa nel catalogo

Compendium

INDEX - INDICE

| | | | | | | | | | | | |
|------------|-----|-------------|-----|-----------|-----|---------|-----|-----------|-----|-----------|-----|
| 16/1 | 187 | 41/20 | 248 | 46/5 | 159 | 49/2 | 111 | 64/H/20 | 84 | 78/B/5 | 203 |
| 16/2 | 187 | 41/21 | 248 | 46/6 | 159 | 49/3 | 97 | 64/H/9/S | 84 | 78/B/6 | 203 |
| 16/3 | 186 | 41/22 | 248 | 46/10 | 159 | 49/4 | 110 | 64/H/10/S | 84 | 80/A/1 | 199 |
| 17/1 | 186 | 41/23 | 248 | 46/11 | 159 | 50/5 | 89 | 65/8 | 94 | 80/A/1/S8 | 199 |
| 17/2 | 186 | 41/24 | 248 | 46/12 | 159 | 50/6 | 89 | 70/D/2 | 94 | 80/A/2 | 199 |
| 18/1 | 186 | 42/1 | 44 | 47/3 | 153 | 50/7 | 89 | 70/D/3 | 94 | 80/A/3 | 199 |
| 18/2 | 186 | 42/2 | 44 | 47/3/1000 | 153 | 50/8 | 89 | 70/D/4 | 155 | 80/A/4 | 199 |
| 18/3 | 187 | 42/3 | 44 | 47/4 | 160 | 50/9 | 89 | 70/D/5 | 155 | 80/A/5 | 199 |
| 18/4 | 187 | 42/4 | 44 | 47/5 | 153 | 50/10 | 89 | 70/D/9 | 155 | 80/A/6 | 199 |
| 18/A/1 | 186 | 42/5 | 44 | 47/6 | 153 | 50/11 | 89 | 70/E/8 | 111 | 80/A/7 | 199 |
| 20/5 | 186 | 42/6 | 44 | 47/9 | 153 | 50/12 | 89 | 73/1 | 208 | 80/A/8 | 199 |
| 20/6 | 186 | 42/7 | 44 | 47/10 | 160 | 50/13 | 89 | 73/2 | 208 | 80/A/9 | 198 |
| 21/4 | 186 | 42/8 | 45 | 47/11 | 153 | 50/14 | 89 | 73/3 | 208 | 80/B/3 | 198 |
| 21/5 | 187 | 42/9 | 45 | 47/12 | 153 | 50/15 | 89 | 74/1 | 198 | 80/B/8 | 198 |
| 22/3 | 187 | 42/10 | 45 | 47/13 | 153 | 50/16 | 89 | 74/2 | 198 | 80/C/7 | 199 |
| 22/A/2 | 186 | 42/11 | 45 | 47/14 | 153 | 51/3 | 111 | 74/3 | 198 | 80/C/8 | 199 |
| 23/1 | 186 | 42/12 | 45 | 47/15 | 153 | 52/1 | 106 | 74/4 | 198 | 80/C/9 | 199 |
| 23/2 | 186 | 42/13 | 45 | 47/16 | 153 | 52/2 | 97 | 74/5 | 198 | 80/A/10 | 198 |
| 23/3 | 186 | 42/14 | 45 | 47/17 | 153 | 52/A/2 | 97 | 74/6 | 198 | 80/A/11 | 198 |
| 24/1 | 187 | 42/15 | 45 | 47/18 | 153 | 52/A/3 | 97 | 74/7 | 198 | 80/A/12 | 198 |
| 24/2 | 187 | 42/16 | 45 | 47/19 | 153 | 52/A/4 | 109 | 74/8 | 198 | 80/A/13 | 199 |
| 24/3 | 188 | 42/17 | 45 | 47/20 | 153 | 52/A/5 | 97 | 74/9 | 198 | 80/A/14 | 199 |
| 24/B/1 | 188 | 42/18 | 45 | 47/22 | 153 | 52/E/1 | 109 | 74/10 | 198 | 80/A/15 | 199 |
| 24/C/2 | 187 | 42/19 | 45 | 47/23 | 153 | 52/E/2 | 110 | 74/11 | 198 | 80/A/16 | 199 |
| 24/F/1 | 105 | 42/20 | 45 | 47/24 | 153 | 52/G/1 | 106 | 74/12 | 198 | 80/A/17 | 198 |
| 26/1 | 186 | 42/21 | 45 | 47/25 | 153 | 53/2 | 111 | 74/13 | 198 | 80/A/18 | 198 |
| 26/2 | 186 | 42/22 | 45 | 47/26 | 153 | 53/3 | 94 | 74/14 | 198 | 80/A/19 | 198 |
| 26/C/1 | 189 | 42/23 | 45 | 47/27 | 153 | 58/3 | 110 | 74/15 | 198 | 80/A/20 | 198 |
| 30/4 | 186 | 42/24 | 45 | 47/28 | 153 | 59/1 | 110 | 74/16 | 198 | 80/A/21 | 199 |
| 30/7 | 186 | 42/25 | 45 | 47/29 | 153 | 62/1 | 105 | 74/17 | 198 | 80/A/22 | 199 |
| 33/2 | 186 | 42/26 | 45 | 47/30 | 153 | 62/2 | 105 | 74/18 | 198 | 80/A/23 | 199 |
| 33/3 | 186 | 42/27 | 45 | 47/31 | 153 | 63/4 | 105 | 74/19 | 198 | 80/A/24 | 198 |
| 35/1 | 215 | 42/28 | 45 | 47/32 | 153 | 64/A/3 | 96 | 74/20 | 198 | 80/A/25 | 198 |
| 35/2 | 215 | 42/A/1 | 44 | 47/33 | 153 | 64/A/7 | 96 | 74/21 | 198 | 80/A/26 | 198 |
| 37/3 | 215 | 42/A/2 | 44 | 47/34 | 153 | 64/B/2 | 96 | 74/22 | 198 | 80/A/27 | 198 |
| 38/1 | 59 | 42/A/3 | 44 | 47/35 | 153 | 64/B/5 | 96 | 74/23 | 198 | 80/A/28 | 199 |
| 38/2 | 59 | 42/A/4 | 44 | 47/36 | 153 | 64/D/1 | 160 | 74/24 | 198 | 80/A/29 | 199 |
| 38/3 | 59 | 42/A/5 | 45 | 48/1 | 102 | 64/D/3 | 157 | 74/25 | 198 | 80/A/30 | 199 |
| 38/4 | 59 | 42/A/6 | 45 | 48/2 | 102 | 64/D/4 | 157 | 74/26 | 198 | 80/A/31 | 198 |
| 40/1 | 59 | 42/A/7 | 45 | 48/3 | 102 | 64/D/5 | 157 | 74/27 | 198 | 80/A/32 | 198 |
| 40/2 | 59 | 42/A/8 | 45 | 48/4 | 102 | 64/D/6 | 157 | 74/28 | 198 | 80/C/10 | 199 |
| 40/3 | 59 | 42/A/9 | 45 | 48/6 | 102 | 64/D/7 | 157 | 75/31 | 209 | 80/C/11 | 199 |
| 40/4 | 59 | 42/B/5 | 163 | 48/7 | 102 | 64/D/8 | 157 | 75/32 | 209 | 80/C/13 | 199 |
| 40/5 | 59 | 42/B/6 | 163 | 48/8 | 102 | 64/D/9 | 157 | 75/33 | 209 | 80/C/14 | 199 |
| 40/A/1 | 59 | 42/B/7 | 163 | 48/9 | 102 | 64/E/1 | 96 | 76/1 | 208 | 80/C/17 | 199 |
| 40/A/2 | 59 | 42/B/8 | 163 | 48/11 | 102 | 64/E/2 | 96 | 76/2 | 208 | 80/C/18 | 199 |
| 40/A/3 | 59 | 42/A/10 | 45 | 48/12 | 102 | 64/E/3 | 96 | 76/3 | 208 | 80/C/19 | 199 |
| 40/B/10 | 58 | 42/A/11 | 45 | 48/13 | 102 | 64/F/1 | 84 | 78/1 | 198 | 80/C/20 | 199 |
| 40/B/12 | 234 | 42/A/12 | 45 | 48/14 | 102 | 64/F/2 | 84 | 78/2 | 198 | 80/C/21 | 199 |
| 40/A/1/S | 59 | 42/A/13 | 45 | 48/A/1 | 102 | 64/F/3 | 84 | 78/3 | 198 | 80/C/23 | 199 |
| 40/B/10/S1 | 58 | 42/A/14 | 45 | 48/A/2 | 102 | 64/F/4 | 84 | 78/4 | 198 | 80/C/24 | 199 |
| 41/1 | 248 | 42/A/15 | 45 | 48/A/3 | 102 | 64/F/5 | 84 | 78/5 | 198 | 81/1 | 206 |
| 41/4 | 248 | 42/A/16 | 45 | 48/A/4 | 102 | 64/F/6 | 84 | 78/6 | 198 | 81/3 | 206 |
| 41/5 | 248 | 42/A/17 | 45 | 48/A/5 | 102 | 64/F/7 | 84 | 78/7 | 198 | 81/5 | 206 |
| 41/6 | 248 | 42/A/18 | 45 | 48/A/7 | 102 | 64/F/8 | 84 | 78/8 | 198 | 81/7 | 206 |
| 41/7 | 248 | 42/A/15/S | 45 | 48/A/8 | 102 | 64/F/9 | 84 | 78/9 | 198 | 82/3 | 206 |
| 41/8 | 248 | 42/B/4/S16 | 55 | 48/A/9 | 102 | 64/G/1 | 84 | 78/10 | 198 | 82/5 | 206 |
| 41/10 | 248 | 42/B/4/S17 | 55 | 48/B/1 | 103 | 64/G/2 | 84 | 78/11 | 198 | 84/1 | 206 |
| 41/11 | 248 | 42/A/16/SP3 | 45 | 48/B/2 | 103 | 64/G/3 | 204 | 78/12 | 198 | 84/2 | 206 |
| 41/12 | 248 | 44/11 | 160 | 48/B/3 | 103 | 64/G/4 | 204 | 78/13 | 198 | 84/5 | 206 |
| 41/13 | 248 | 44/12 | 160 | 48/B/4 | 103 | 64/G/5 | 204 | 78/14 | 198 | 84/6 | 206 |
| 41/14 | 248 | 44/13 | 160 | 48/B/5 | 103 | 64/G/6 | 204 | 78/15 | 205 | 84/7 | 206 |
| 41/15 | 248 | 45/19 | 160 | 48/B/6 | 103 | 64/H/9 | 84 | 78/16 | 205 | 84/8 | 206 |
| 41/16 | 248 | 45/20 | 160 | 48/B/7 | 103 | 64/I/1 | 91 | 78/B/1 | 203 | 85/8 | 39 |
| 41/17 | 248 | 45/22 | 160 | 48/B/8 | 103 | 64/D/10 | 157 | 78/B/2 | 203 | 85/9 | 39 |
| 41/18 | 248 | 46/3 | 159 | 48/A/11 | 102 | 64/H/10 | 84 | 78/B/3 | 203 | 86/5 | 203 |
| 41/19 | 248 | 46/4 | 159 | 48/A/12 | 102 | 64/H/19 | 84 | 78/B/4 | 203 | 87/1 | 203 |

Not all of the Arteferro items are available in **Arteferro Quick**, just a special selection.

Find out about the entire range in the catalogue

In **Arteferro Quick** non sono presenti tutti gli articoli Arteferro, ma solo una speciale selezione.

Scopri la gamma completa nel catalogo

Compendium

INDEX - INDICE

| | | | | | | | | | | | |
|--------|-----|----------|-----|-----------------|----|----------|-----|-------------|-----|----------|-----|
| 87/3 | 206 | 94/P/2 | 200 | 114/6 | 34 | 116/13 | 34 | 116/F/18 | 218 | 118/C/2 | 163 |
| 87/4 | 206 | 94/P/3 | 200 | 114/7 | 34 | 116/14 | 32 | 116/F/19 | 218 | 118/C/3 | 163 |
| 87/5 | 203 | 94/P/4 | 200 | 114/8 | 34 | 116/15 | 34 | 116/10/S1 | 32 | 118/C/4 | 163 |
| 87/6 | 203 | 94/P/9 | 200 | 114/9 | 22 | 116/16 | 34 | 116/10/S3 | 32 | 118/C/5 | 163 |
| 88/1 | 208 | 94/Q/1 | 200 | 114/10 | 32 | 116/25 | 34 | 116/10/S7 | 32 | 118/C/6 | 163 |
| 88/2 | 208 | 94/Q/2 | 200 | 114/11 | 34 | 116/26 | 33 | 116/10/XL | 32 | 118/C/7 | 163 |
| 88/3 | 208 | 94/Q/3 | 200 | 114/12 | 34 | 116/27 | 34 | 116/11/XL | 34 | 118/C/8 | 163 |
| 88/4 | 208 | 94/Q/4 | 200 | 114/13 | 32 | 116/28 | 34 | 116/36/S1 | 32 | 118/C/9 | 163 |
| 88/5 | 208 | 94/Q/5 | 200 | 114/14 | 32 | 116/29 | 34 | 116/37/S1 | 32 | 118/E/1 | 24 |
| 88/6 | 208 | 94/Q/6 | 200 | 114/A/1 | 28 | 116/30 | 33 | 117/1 | 218 | 118/E/2 | 24 |
| 88/10 | 203 | 94/Q/7 | 200 | 114/A/2 | 28 | 116/31 | 34 | 117/2 | 218 | 118/E/3 | 24 |
| 88/A/3 | 203 | 94/Q/8 | 200 | 114/A/3 | 26 | 116/32 | 34 | 117/3 | 218 | 118/E/4 | 24 |
| 88/H/2 | 198 | 94/B/11 | 236 | 114/A/5 | 35 | 116/33 | 247 | 117/4 | 218 | 118/E/5 | 24 |
| 88/H/3 | 198 | 94/B/12 | 236 | 114/A/6 | 35 | 116/34 | 247 | 117/5 | 218 | 118/E/6 | 24 |
| 88/H/4 | 198 | 94/C/10 | 214 | 114/B/1 | 28 | 116/35 | 247 | 117/6 | 218 | 118/E/7 | 24 |
| 88/I/2 | 200 | 94/C/11 | 214 | 114/B/2 | 28 | 116/36 | 32 | 117/7 | 218 | 118/E/8 | 24 |
| 88/I/3 | 200 | 94/C/12 | 214 | 114/B/3 | 31 | 116/37 | 32 | 117/8 | 218 | 118/E/9 | 24 |
| 88/L/3 | 200 | 94/C/13 | 214 | 114/B/4 | 34 | 116/39 | 33 | 117/9 | 218 | 118/F/1 | 37 |
| 88/L/4 | 200 | 94/C/14 | 214 | 114/B/5 | 32 | 116/6/S | 32 | 117/10 | 37 | 118/F/2 | 37 |
| 88/N/1 | 206 | 94/P/10 | 200 | 114/B/6 | 34 | 116/A/1 | 245 | 117/11 | 37 | 118/F/3 | 37 |
| 88/N/2 | 206 | 94/P/11 | 200 | 114/B/7 | 34 | 116/A/2 | 245 | 117/12 | 37 | 118/F/4 | 37 |
| 88/N/3 | 205 | 94/P/12 | 200 | 114/B/8 | 34 | 116/A/3 | 234 | 117/13 | 37 | 118/F/5 | 37 |
| 88/N/4 | 206 | 97/2 | 110 | 114/B/9 | 32 | 116/A/4 | 234 | 117/14 | 37 | 118/F/6 | 37 |
| 88/N/5 | 206 | 98/1 | 76 | 114/10/S | 32 | 116/A/5 | 234 | 117/15 | 218 | 118/F/7 | 34 |
| 88/N/6 | 205 | 99/1/C | 76 | 114/9/S2 | 22 | 116/A/6 | 245 | 117/16 | 218 | 118/F/8 | 34 |
| 88/N/7 | 206 | 99/2/C | 76 | 114/B/10 | 34 | 116/A/7 | 245 | 117/1/L | 218 | 118/F/9 | 34 |
| 88/P/1 | 203 | 102/4 | 110 | 114/B/11 | 34 | 116/A/8 | 34 | 118/1 | 20 | 118/H/1 | 94 |
| 88/P/2 | 203 | 104/3 | 77 | 114/B/12 | 32 | 116/A/9 | 33 | 118/2 | 20 | 118/H/2 | 94 |
| 88/P/3 | 203 | 104/4 | 77 | 114/B/13 | 26 | 116/D/1 | 69 | 118/3 | 20 | 118/H/3 | 94 |
| 92/B/3 | 213 | 105/3 | 78 | 114/B/14 | 26 | 116/D/2 | 69 | 118/4 | 20 | 118/H/4 | 94 |
| 92/B/4 | 213 | 105/1/C | 78 | 114/B/15 | 26 | 116/E/1 | 70 | 118/5 | 20 | 118/H/5 | 36 |
| 92/C/3 | 213 | 105/2/C | 78 | 114/B/5/S | 32 | 116/E/2 | 70 | 118/6 | 20 | 118/H/6 | 36 |
| 93/1 | 213 | 105/5/C | 78 | 114/4/6000 | 34 | 116/E/3 | 70 | 118/7 | 22 | 118/H/7 | 36 |
| 93/2 | 213 | 109/3 | 76 | 114/5/6000 | 32 | 116/E/4 | 70 | 118/8 | 22 | 118/H/8 | 36 |
| 93/3 | 213 | 110/3 | 77 | 114/6/6000 | 34 | 116/E/6 | 69 | 118/10 | 23 | 118/H/9 | 36 |
| 93/4 | 213 | 112/3 | 95 | 114/7/6000 | 34 | 116/F/1 | 218 | 118/11 | 23 | 118/15/S | 21 |
| 94/1 | 213 | 112/4 | 95 | 114/8/6000 | 34 | 116/F/2 | 218 | 118/12 | 23 | 118/23/S | 21 |
| 94/2 | 213 | 112/5 | 76 | 114/9/35X8 | 22 | 116/F/3 | 218 | 118/13 | 23 | 118/24/S | 20 |
| 94/3 | 213 | 112/6 | 76 | 114/9/6000 | 22 | 116/F/4 | 218 | 118/14 | 23 | 118/7/S1 | 22 |
| 94/A/1 | 247 | 112/7 | 77 | 114/B/5/S3 | 32 | 116/F/5 | 218 | 118/15 | 21 | 118/8/S1 | 22 |
| 94/A/2 | 247 | 112/8 | 77 | 114/B13/S9 | 26 | 116/F/6 | 218 | 118/16 | 21 | 118/9/S1 | 22 |
| 94/A/7 | 245 | 112/9 | 77 | 114/10/6000 | 32 | 116/F/7 | 218 | 118/17 | 21 | 118/A/10 | 19 |
| 94/A/8 | 245 | 112/11 | 75 | 114/11/6000 | 34 | 116/F/8 | 218 | 118/18 | 21 | 118/A/11 | 19 |
| 94/B/5 | 234 | 112/B/9 | 104 | 114/12/6000 | 34 | 116/F/9 | 218 | 118/19 | 21 | 118/A/12 | 19 |
| 94/B/6 | 234 | 112/B/10 | 104 | 114/13/6000 | 32 | 116/14/S | 32 | 118/20 | 21 | 118/A/13 | 19 |
| 94/B/7 | 236 | 112/B/11 | 104 | 114/14/6000 | 32 | 116/2/S1 | 32 | 118/21 | 21 | 118/A/14 | 19 |
| 94/B/8 | 236 | 112/B/12 | 104 | 114/A/3/6000 | 26 | 116/2/S2 | 32 | 118/22 | 21 | 118/A/15 | 19 |
| 94/C/1 | 214 | 112/B/13 | 104 | 114/A/5/6000 | 35 | 116/A/10 | 34 | 118/23 | 21 | 118/A/16 | 19 |
| 94/C/2 | 214 | 112/B/14 | 104 | 114/A/6/6000 | 35 | 116/A/11 | 34 | 118/24 | 20 | 118/C/10 | 163 |
| 94/C/3 | 214 | 112/B/15 | 104 | 114/9/35X8/6000 | 22 | 116/A/12 | 34 | 118/25 | 20 | 118/C/11 | 163 |
| 94/C/4 | 214 | 112/B/16 | 104 | 115/1 | 31 | 116/A/14 | 34 | 118/26 | 23 | 118/C/12 | 163 |
| 94/C/5 | 214 | 113/1 | 104 | 115/2 | 31 | 116/A/15 | 34 | 118/27 | 23 | 118/C/13 | 163 |
| 94/C/6 | 214 | 113/2 | 104 | 115/3 | 31 | 116/A/16 | 33 | 118/28 | 23 | 118/C/14 | 163 |
| 94/C/9 | 214 | 113/3 | 104 | 115/4 | 31 | 116/A/17 | 182 | 118/29 | 23 | 118/C/15 | 163 |
| 94/E/1 | 214 | 113/4 | 104 | 115/5 | 31 | 116/A/18 | 182 | 118/29/6000 | 23 | 118/C/16 | 163 |
| 94/E/2 | 214 | 113/5 | 89 | 116/1 | 34 | 116/A/19 | 182 | 118/30 | 23 | 118/C/17 | 163 |
| 94/E/3 | 214 | 113/6 | 89 | 116/2 | 32 | 116/A/20 | 182 | 118/7/S | 22 | 118/C/18 | 163 |
| 94/E/4 | 214 | 113/7 | 95 | 116/3 | 34 | 116/A/21 | 182 | 118/A/1 | 20 | 118/C/19 | 163 |
| 94/E/5 | 214 | 113/8 | 95 | 116/4 | 34 | 116/A/22 | 182 | 118/A/2 | 20 | 118/C/20 | 163 |
| 94/E/6 | 214 | 113/9 | 182 | 116/5 | 34 | 116/F/10 | 218 | 118/A/3 | 20 | 118/C/21 | 163 |
| 94/F/1 | 214 | 113/10 | 182 | 116/6 | 32 | 116/F/11 | 218 | 118/A/4 | 20 | 118/C/22 | 163 |
| 94/F/2 | 214 | 113/11 | 218 | 116/7 | 34 | 116/F/12 | 218 | 118/A/5 | 20 | 118/C/23 | 163 |
| 94/F/3 | 214 | 113/12 | 218 | 116/8 | 34 | 116/F/13 | 218 | 118/A/5 | 65 | 118/C/24 | 163 |
| 94/F/4 | 214 | 114/1 | 30 | 116/9 | 34 | 116/F/14 | 218 | 118/A/7 | 23 | 118/C/25 | 163 |
| 94/F/5 | 214 | 114/2 | 30 | 116/10 | 32 | 116/F/15 | 218 | 118/A/8 | 23 | 118/C/26 | 163 |
| 94/F/6 | 214 | 114/4 | 34 | 116/11 | 34 | 116/F/16 | 218 | 118/A/9 | 23 | 118/C/27 | 163 |
| 94/P/1 | 200 | 114/5 | 32 | 116/12 | 34 | 116/F/17 | 218 | 118/C/1 | 163 | 118/C/28 | 163 |

Not all of the Arterferro items are available in **Arterferro Quick**, just a special selection.

Find out about the entire range in the catalogue

In **Arterferro Quick** non sono presenti tutti gli articoli Arterferro, ma solo una speciale selezione.

Scopri la gamma completa nel catalogo

Compendium

INDEX - INDICE

| | | | | | | | | | | | |
|----------|-----|-------------------|-----|-------------------|-----|----------|-----|----------|-----|--------|-----|
| 118/C/29 | 163 | 118/H/24 | 36 | 118/A/4/6000 | 20 | 123/3 | 180 | 127/2 | 178 | 129/4 | 165 |
| 118/C/30 | 163 | 118/H/25 | 36 | 118/A/5/6000 | 20 | 123/5 | 180 | 127/3 | 228 | 129/5 | 165 |
| 118/C/31 | 163 | 118/H/26 | 36 | 118/A/6/50X8 | 23 | 123/6 | 178 | 127/4 | 228 | 129/6 | 165 |
| 118/C/32 | 163 | 118/H/30 | 94 | 118/A/6/6000 | 23 | 124/1 | 179 | 127/5 | 228 | 129/7 | 167 |
| 118/C/33 | 163 | 118/13/S | 23 | 118/A/6/S/L6 | 23 | 124/2 | 179 | 127/6 | 228 | 129/8 | 167 |
| 118/C/34 | 163 | 118/13/S/6000 | 23 | 118/A/7/6000 | 23 | 124/3 | 179 | 127/7 | 228 | 129/9 | 166 |
| 118/C/35 | 163 | 118/10/S1 | 23 | 118/A/8/6000 | 23 | 124/4 | 179 | 127/8 | 228 | 129/10 | 166 |
| 118/C/36 | 163 | 118/13/S1 | 23 | 118/A/9/6000 | 23 | 124/5 | 179 | 127/9 | 228 | 129/11 | 168 |
| 118/C/37 | 163 | 118/14/S2 | 23 | 118/C/40/T16 | 163 | 124/6 | 178 | 127/10 | 228 | 129/12 | 168 |
| 118/C/38 | 163 | 118/14/S2/6000 | 23 | 118/F/7/3000 | 34 | 124/7 | 179 | 127/11 | 228 | 129/15 | 174 |
| 118/C/39 | 163 | 118/14/S3 | 23 | 118/F/8/3000 | 34 | 124/8 | 179 | 127/12 | 228 | 129/16 | 175 |
| 118/C/40 | 163 | 118/27/S | 23 | 118/24/6000/S | 20 | 124/9 | 179 | 127/13 | 228 | 129/17 | 166 |
| 118/C/41 | 163 | 118/27/6000 | 23 | 118/7/S1/6000 | 22 | 124/11 | 171 | 127/14 | 228 | 129/18 | 166 |
| 118/C/42 | 163 | 118/A/6/S | 23 | 118/8/S1/6000 | 22 | 124/12 | 171 | 127/15 | 228 | 129/19 | 175 |
| 118/C/43 | 163 | 118/A/6/20X8 | 23 | 118/9/S1/6000 | 22 | 124/13 | 171 | 127/16 | 228 | 129/20 | 175 |
| 118/C/44 | 163 | 118/A/6/20X8/6000 | 23 | 118/C/13/1200 | 163 | 124/14 | 171 | 128/1 | 225 | 130/1 | 167 |
| 118/C/45 | 163 | 118/A/9/S | 23 | 118/C/16/1200 | 163 | 125/1 | 178 | 128/2 | 225 | 130/2 | 167 |
| 118/C/46 | 163 | 118/C/106 | 163 | 118/C/20/1200 | 163 | 125/2 | 178 | 128/3 | 224 | 130/3 | 167 |
| 118/C/47 | 163 | 118/1/6000 | 20 | 118/C/23/1200 | 163 | 126/1 | 180 | 128/4 | 224 | 130/4 | 167 |
| 118/C/48 | 163 | 118/15/Q/6 | 21 | 118/C/27/1200 | 163 | 126/2 | 180 | 128/5 | 224 | 130/5 | 167 |
| 118/C/49 | 163 | 118/2/6000 | 20 | 118/C/28/1200 | 163 | 126/6 | 178 | 128/6 | 224 | 130/6 | 167 |
| 118/C/50 | 163 | 118/3/6000 | 20 | 118/C/39/1200 | 163 | 126/8 | 179 | 128/7 | 224 | 130/7 | 167 |
| 118/C/51 | 163 | 118/4/6000 | 20 | 118/C/42/1200 | 163 | 126/9 | 178 | 128/8 | 224 | 130/8 | 165 |
| 118/C/52 | 163 | 118/5/6000 | 20 | 118/C/44/1200 | 163 | 126/13 | 179 | 128/9 | 224 | 130/9 | 167 |
| 118/C/53 | 163 | 118/6/6000 | 20 | 118/1/Q10/6000 | 20 | 126/14 | 179 | 128/10 | 224 | 130/10 | 167 |
| 118/C/54 | 163 | 118/7/6000 | 22 | 118/A/6/S/6000 | 23 | 126/15 | 180 | 128/11 | 224 | 130/11 | 165 |
| 118/C/55 | 163 | 118/8/6000 | 22 | 118/A/9/S/6000 | 23 | 126/16 | 180 | 128/12 | 224 | 130/12 | 165 |
| 118/C/56 | 163 | 118/A/6/SS | 23 | 118/7/20X6/6000 | 22 | 126/18 | 180 | 128/13 | 224 | 130/13 | 165 |
| 118/C/57 | 163 | 118/E/2/S1 | 25 | 118/A/6/50X8/6000 | 23 | 126/19 | 178 | 128/14 | 224 | 130/14 | 165 |
| 118/C/58 | 163 | 118/E/2/S2 | 25 | 119/1 | 37 | 126/20 | 178 | 128/15 | 224 | 130/15 | 165 |
| 118/C/59 | 163 | 118/E/3/S4 | 25 | 119/1/5400 | 37 | 126/21 | 179 | 128/16 | 225 | 130/16 | 165 |
| 118/C/60 | 163 | 118/E/3/S5 | 25 | 119/2 | 37 | 126/A/1 | 180 | 128/17 | 225 | 130/17 | 165 |
| 118/C/61 | 163 | 118/E/4/S2 | 25 | 119/2/5400 | 37 | 126/A/2 | 177 | 128/18 | 225 | 130/18 | 165 |
| 118/C/62 | 163 | 118/E/4/S3 | 25 | 119/3 | 37 | 126/A/3 | 171 | 128/19 | 225 | 130/19 | 165 |
| 118/C/63 | 176 | 118/E/4/S4 | 25 | 119/3/5400 | 37 | 126/A/4 | 171 | 128/20 | 225 | 130/20 | 165 |
| 118/C/64 | 163 | 118/E/5/S3 | 25 | 119/4 | 94 | 126/A/5 | 171 | 128/21 | 225 | 130/21 | 165 |
| 118/C/65 | 163 | 118/E/6/S1 | 25 | 119/5 | 94 | 126/A/6 | 171 | 128/22 | 225 | 130/22 | 165 |
| 118/C/66 | 163 | 118/E/6/S3 | 25 | 119/6 | 94 | 126/A/7 | 171 | 128/23 | 225 | 130/23 | 165 |
| 118/C/67 | 163 | 118/E/6/S4 | 25 | 119/9 | 94 | 126/A/8 | 171 | 128/24 | 225 | 130/24 | 165 |
| 118/C/68 | 163 | 118/E/6/S5 | 25 | 119/10 | 94 | 126/A/9 | 171 | 128/25 | 225 | 130/25 | 165 |
| 118/C/72 | 163 | 118/E/7/S3 | 25 | 119/11 | 94 | 126/B/1 | 179 | 128/26 | 225 | 130/26 | 165 |
| 118/C/96 | 163 | 118/E/7/S5 | 25 | 119/12 | 94 | 126/B/2 | 179 | 128/27 | 225 | 130/27 | 165 |
| 118/C/97 | 163 | 118/E/8/S1 | 24 | 119/13 | 94 | 126/B/3 | 179 | 128/28 | 225 | 130/29 | 165 |
| 118/E/10 | 24 | 118/E/9/S1 | 25 | 119/16 | 94 | 126/B/6 | 179 | 128/31 | 181 | 130/30 | 165 |
| 118/E/12 | 24 | 118/E/9/S2 | 25 | 119/17 | 94 | 126/B/7 | 179 | 128/35 | 181 | 130/31 | 166 |
| 118/E/13 | 24 | 118/11/6000 | 23 | 119/18 | 94 | 126/B/8 | 179 | 128/36 | 225 | 130/32 | 166 |
| 118/E/14 | 24 | 118/12/6000 | 23 | 119/19 | 94 | 126/B/9 | 180 | 128/37 | 225 | 130/33 | 166 |
| 118/E/15 | 24 | 118/13/6000 | 23 | 119/20 | 94 | 126/C/7 | 180 | 128/38 | 225 | 130/34 | 166 |
| 118/E/16 | 25 | 118/14/6000 | 23 | 119/23 | 94 | 126/C/8 | 180 | 128/39 | 225 | 130/35 | 166 |
| 118/E/17 | 24 | 118/15/6000 | 21 | 119/24 | 94 | 126/D/1 | 178 | 128/C/2 | 181 | 130/36 | 166 |
| 118/E/18 | 24 | 118/16/6000 | 21 | 119/25 | 95 | 126/E/1 | 180 | 128/C/3 | 227 | 130/37 | 166 |
| 118/E/19 | 24 | 118/17/6000 | 21 | 119/26 | 95 | 126/F/1 | 224 | 128/C/4 | 227 | 130/38 | 166 |
| 118/F/10 | 34 | 118/18/6000 | 21 | 119/27 | 95 | 126/F/2 | 224 | 128/C/5 | 227 | 130/39 | 166 |
| 118/H/10 | 36 | 118/19/6000 | 21 | 119/28 | 100 | 126/F/3 | 224 | 128/C/6 | 227 | 130/40 | 166 |
| 118/H/11 | 36 | 118/20/6000 | 21 | 120/1 | 174 | 126/F/4 | 224 | 128/C/7 | 227 | 130/41 | 168 |
| 118/H/12 | 36 | 118/21/6000 | 21 | 120/2 | 174 | 126/F/5 | 224 | 128/C/8 | 227 | 130/42 | 168 |
| 118/H/13 | 36 | 118/22/6000 | 21 | 120/3 | 174 | 126/F/6 | 225 | 128/C/9 | 226 | 130/43 | 168 |
| 118/H/14 | 36 | 118/23/6000 | 21 | 121/4 | 174 | 126/F/7 | 225 | 128/D/9 | 175 | 130/44 | 168 |
| 118/H/15 | 36 | 118/24/6000 | 20 | 121/5 | 174 | 126/F/8 | 225 | 128/C/10 | 226 | 130/45 | 168 |
| 118/H/16 | 36 | 118/25/6000 | 20 | 121/6 | 174 | 126/F/9 | 225 | 128/C/11 | 226 | 130/46 | 168 |
| 118/H/17 | 36 | 118/C/1/Q16 | 163 | 121/7 | 174 | 126/A/10 | 171 | 128/C/12 | 227 | 130/47 | 168 |
| 118/H/18 | 36 | 118/C/7/Q16 | 163 | 121/8 | 174 | 126/F/10 | 225 | 128/C/13 | 227 | 130/48 | 168 |
| 118/H/19 | 36 | 118/7/S/6000 | 22 | 121/9 | 174 | 126/F/11 | 226 | 128/C/14 | 227 | 130/49 | 168 |
| 118/H/20 | 36 | 118/9/S/6000 | 22 | 121/10 | 174 | 126/F/12 | 226 | 128/C/15 | 227 | 130/50 | 168 |
| 118/H/21 | 36 | 118/A/1/6000 | 20 | 121/11 | 174 | 126/F/13 | 226 | 129/1 | 165 | 130/51 | 165 |
| 118/H/22 | 36 | 118/A/2/6000 | 20 | 122/A/1 | 178 | 126/F/14 | 226 | 129/2 | 165 | 130/52 | 165 |
| 118/H/23 | 36 | 118/A/3/6000 | 20 | 123/1 | 218 | 127/1 | 178 | 129/3 | 165 | 130/53 | 165 |

Not all of the Arterferro items are available in **Arterferro Quick**, just a special selection.

Find out about the entire range in the catalogue

In **Arterferro Quick** non sono presenti tutti gli articoli Arterferro, ma solo una speciale selezione.

Scopri la gamma completa nel catalogo

Compendium

INDEX - INDICE

| | | | | | | | | | | | |
|----------|-----|----------|-----|----------|-----|---------------|-----|----------|-----|-------------|-----|
| 130/54 | 165 | 132/B/88 | 164 | 148/2 | 92 | 158/18 | 40 | 164/8 | 255 | 171/39 | 248 |
| 130/55 | 165 | 132/C/10 | 164 | 149/1 | 92 | 158/19 | 40 | 164/9 | 255 | 171/40 | 248 |
| 130/56 | 165 | 132/C/12 | 164 | 149/2 | 92 | 158/20 | 38 | 164/10 | 255 | 171/41 | 248 |
| 130/57 | 165 | 132/C/13 | 164 | 154/1 | 222 | 158/21 | 38 | 167/3 | 183 | 171/42 | 248 |
| 130/58 | 165 | 132/C/14 | 164 | 154/2 | 222 | 158/22 | 38 | 167/4 | 183 | 178/20 | 183 |
| 130/59 | 165 | 132/C/15 | 164 | 154/3 | 222 | 158/23 | 38 | 167/6 | 183 | 178/22 | 183 |
| 130/60 | 165 | 132/C/16 | 164 | 154/4 | 222 | 158/24 | 38 | 167/8 | 183 | 178/24 | 183 |
| 132/48 | 164 | 132/C/17 | 164 | 154/5 | 222 | 158/25 | 38 | 167/11 | 183 | 178/29 | 183 |
| 132/C/1 | 164 | 132/C/18 | 164 | 154/A/1 | 222 | 158/26 | 38 | 167/14 | 183 | 178/30 | 183 |
| 132/C/2 | 164 | 132/C/19 | 164 | 154/A/2 | 222 | 158/27 | 38 | 167/15 | 174 | 178/31 | 183 |
| 132/C/3 | 164 | 132/C/20 | 164 | 154/A/3 | 222 | 158/28 | 38 | 167/16 | 174 | 178/35 | 183 |
| 132/C/4 | 164 | 132/C/21 | 164 | 154/A/4 | 222 | 158/29 | 38 | 168/3 | 250 | 178/36 | 183 |
| 132/C/5 | 164 | 132/C/22 | 164 | 154/A/5 | 222 | 158/30 | 38 | 168/4 | 250 | 180/50 | 20 |
| 132/C/6 | 164 | 132/C/23 | 164 | 154/A/6 | 222 | 158/31 | 39 | 168/5 | 250 | 180/51 | 23 |
| 132/C/7 | 164 | 132/C/28 | 164 | 154/A/7 | 222 | 158/32 | 39 | 168/6 | 250 | 180/53 | 20 |
| 132/C/8 | 164 | 132/C/29 | 164 | 154/A/8 | 222 | 158/33 | 39 | 169/1 | 251 | 180/54 | 20 |
| 132/C/9 | 164 | 132/D/10 | 164 | 154/B/1 | 222 | 158/34 | 41 | 169/2 | 251 | 180/50/6000 | 20 |
| 132/C/32 | 164 | 132/D/11 | 164 | 154/B/2 | 222 | 158/35 | 41 | 169/3 | 251 | 180/53/6000 | 20 |
| 132/D/1 | 164 | 132/D/12 | 164 | 154/B/3 | 222 | 158/36 | 41 | 169/4 | 250 | 180/54/6000 | 20 |
| 132/D/2 | 164 | 132/D/13 | 164 | 154/B/4 | 222 | 158/37 | 41 | 169/5 | 253 | 181/6 | 245 |
| 132/D/3 | 164 | 132/D/14 | 164 | 154/B/5 | 222 | 158/38 | 41 | 169/6 | 253 | 181/7 | 39 |
| 132/D/4 | 164 | 132/D/15 | 164 | 154/B/6 | 222 | 158/39 | 41 | 169/7 | 253 | 181/8 | 39 |
| 132/D/5 | 164 | 132/D/16 | 164 | 155/1 | 222 | 158/40 | 41 | 169/8 | 253 | 181/10 | 254 |
| 132/D/6 | 164 | 132/D/17 | 164 | 155/2 | 222 | 158/41 | 41 | 169/9 | 253 | 181/11 | 254 |
| 132/D/7 | 164 | 132/D/18 | 164 | 155/3 | 222 | 158/42 | 41 | 169/10 | 253 | 181/12 | 254 |
| 132/D/8 | 164 | 132/D/19 | 164 | 155/4 | 222 | 158/43 | 41 | 169/11 | 250 | 181/13 | 255 |
| 132/D/9 | 164 | 132/D/20 | 164 | 155/5 | 222 | 158/44 | 41 | 169/12 | 250 | 181/14 | 255 |
| 132/B/37 | 164 | 134/2 | 80 | 155/6 | 222 | 158/49 | 40 | 169/13 | 250 | 181/15 | 254 |
| 132/B/38 | 164 | 134/4 | 80 | 155/7 | 222 | 158/50 | 40 | 169/15 | 250 | 182/1 | 254 |
| 132/B/39 | 164 | 134/7 | 167 | 156/1 | 195 | 158/51 | 40 | 170/1 | 253 | 182/2 | 254 |
| 132/B/40 | 164 | 134/10 | 80 | 156/2 | 195 | 158/52 | 40 | 170/2 | 253 | 185/9 | 263 |
| 132/B/41 | 164 | 134/12 | 80 | 156/3 | 195 | 158/53 | 40 | 170/3 | 253 | 199/1 | 241 |
| 132/B/42 | 164 | 134/18 | 167 | 156/5 | 195 | 158/54 | 40 | 170/5 | 253 | 199/2 | 241 |
| 132/B/43 | 164 | 134/19 | 167 | 156/6 | 195 | 158/9/C | 26 | 170/6 | 252 | 199/3 | 241 |
| 132/B/44 | 164 | 134/20 | 167 | 156/A/7 | 249 | 158/B/1 | 230 | 170/7 | 252 | 199/4 | 241 |
| 132/B/45 | 164 | 134/21 | 167 | 156/A/8 | 249 | 158/B/2 | 230 | 170/A/1 | 253 | 199/5 | 241 |
| 132/B/46 | 164 | 134/22 | 167 | 156/A/10 | 249 | 158/B/3 | 230 | 170/A/2 | 256 | 199/6 | 241 |
| 132/B/47 | 164 | 134/B/2 | 80 | 156/A/11 | 249 | 158/B/4 | 230 | 170/A/3 | 256 | 199/7 | 241 |
| 132/B/49 | 164 | 134/B/4 | 80 | 156/A/12 | 249 | 158/B/5 | 230 | 170/A/4 | 253 | 199/8 | 241 |
| 132/B/50 | 164 | 134/C/2 | 80 | 157/1 | 194 | 158/B/6 | 231 | 170/A/5 | 252 | 199/9 | 241 |
| 132/B/51 | 164 | 134/C/3 | 80 | 157/2 | 194 | 158/B/7 | 231 | 170/A/6 | 253 | 199/10 | 241 |
| 132/B/52 | 164 | 134/C/5 | 80 | 157/3 | 194 | 158/B/8 | 231 | 170/A/7 | 253 | 199/11 | 241 |
| 132/B/53 | 164 | 134/C/6 | 80 | 157/4 | 194 | 158/10/C | 26 | 170/A/8 | 253 | 199/12 | 241 |
| 132/B/54 | 164 | 134/D/9 | 80 | 157/5 | 194 | 158/12/C | 26 | 170/A/9 | 253 | 199/13 | 241 |
| 132/B/55 | 164 | 134/G/1 | 110 | 157/6 | 194 | 158/45/C | 26 | 170/B/1 | 254 | 199/14 | 241 |
| 132/B/56 | 164 | 134/G/2 | 110 | 157/7 | 194 | 158/47/C | 26 | 170/B/2 | 254 | 199/15 | 241 |
| 132/B/57 | 164 | 136/1 | 235 | 157/8 | 194 | 158/9/C/6000 | 26 | 170/B/3 | 254 | 199/16 | 241 |
| 132/B/58 | 164 | 136/2 | 235 | 157/9 | 194 | 158/10/C/6000 | 26 | 170/B/4 | 255 | 199/17 | 241 |
| 132/B/59 | 164 | 136/3 | 235 | 157/10 | 194 | 158/12/C/6000 | 26 | 170/B/5 | 254 | 200/3 | 54 |
| 132/B/60 | 164 | 136/4 | 235 | 157/11 | 194 | 158/45/C/6000 | 26 | 170/A/10 | 253 | 200/5 | 54 |
| 132/B/61 | 164 | 136/12 | 235 | 157/12 | 194 | 158/47/C/6000 | 26 | 170/A/11 | 253 | 200/9 | 54 |
| 132/B/62 | 164 | 136/13 | 235 | 157/13 | 194 | 159/1 | 230 | 171/1 | 240 | 200/12 | 54 |
| 132/B/63 | 164 | 138/1 | 234 | 157/14 | 194 | 159/2 | 230 | 171/2 | 240 | 200/14 | 54 |
| 132/B/64 | 164 | 138/2 | 234 | 157/15 | 194 | 159/3 | 230 | 171/3 | 240 | 200/16 | 54 |
| 132/B/65 | 164 | 138/4 | 234 | 158/1 | 40 | 159/4 | 230 | 171/4 | 240 | 200/18 | 54 |
| 132/B/66 | 164 | 138/15 | 234 | 158/2 | 40 | 159/5 | 230 | 171/5 | 240 | 200/5/S28 | 55 |
| 132/B/67 | 164 | 140/F/3 | 235 | 158/3 | 38 | 159/6 | 230 | 171/6 | 240 | 200/5/S44 | 55 |
| 132/B/68 | 164 | 140/F/4 | 235 | 158/4 | 39 | 159/7 | 230 | 171/7 | 240 | 200/5/S45 | 55 |
| 132/B/69 | 164 | 140/H/1 | 236 | 158/5 | 41 | 159/9 | 230 | 171/8 | 240 | 200/5/S46 | 55 |
| 132/B/70 | 164 | 140/H/2 | 236 | 158/6 | 41 | 159/10 | 230 | 171/9 | 240 | 200/18/S12 | 55 |
| 132/B/71 | 164 | 140/I/2 | 235 | 158/7 | 41 | 164/1 | 255 | 171/10 | 240 | 200/18/S13 | 55 |
| 132/B/72 | 164 | 140/I/3 | 235 | 158/8 | 41 | 164/2 | 255 | 171/11 | 240 | 200/18/S14 | 55 |
| 132/B/83 | 164 | 145/3 | 93 | 158/13 | 40 | 164/3 | 255 | 171/12 | 240 | 200/18/S24 | 55 |
| 132/B/84 | 164 | 145/4 | 93 | 158/14 | 40 | 164/4 | 255 | 171/13 | 240 | 202/1 | 218 |
| 132/B/85 | 164 | 146/1 | 93 | 158/15 | 40 | 164/5 | 255 | 171/14 | 240 | 202/2 | 218 |
| 132/B/86 | 164 | 146/4 | 93 | 158/16 | 40 | 164/6 | 255 | 171/37 | 248 | 202/3 | 218 |
| 132/B/87 | 164 | 148/1 | 92 | 158/17 | 40 | 164/7 | 255 | 171/38 | 248 | 202/4 | 218 |

Not all of the Arteferro items are available in **Arteferro Quick**, just a special selection.

Find out about the entire range in the catalogue

In **Arteferro Quick** non sono presenti tutti gli articoli Arteferro, ma solo una speciale selezione.

Scopri la gamma completa nel catalogo

Compendium

INDEX - INDICE

| | | | | | | | | | | | |
|--------|-----|------------|-----|------------|-----|-------------|-----|-------------|-----|--------------|----|
| 202/5 | 218 | 491/8 | 194 | 573/7 | 84 | 587/2 | 81 | 599/1 | 19 | 617/4 | 99 |
| 202/6 | 218 | 491/9 | 195 | 573/8 | 84 | 587/4 | 81 | 599/2 | 19 | 617/5 | 99 |
| 202/7 | 218 | 491/16 | 194 | 573/9 | 84 | 587/5 | 81 | 599/3 | 19 | 617/6 | 99 |
| 227/1 | 257 | 491/17 | 194 | 573/10 | 84 | 587/6 | 81 | 599/4 | 19 | 617/7 | 99 |
| 227/2 | 257 | 491/8/D89 | 194 | 576/1 | 85 | 587/7 | 81 | 599/5 | 19 | 620/1 | 59 |
| 227/3 | 257 | 491/8/D127 | 194 | 576/2 | 85 | 587/8 | 81 | 599/6 | 19 | 621/1 | 59 |
| 227/4 | 257 | 491/8/D133 | 194 | 576/3 | 85 | 587/9 | 81 | 599/7 | 19 | 622/1 | 22 |
| 227/16 | 257 | 491/8/D140 | 194 | 576/5 | 85 | 587/10 | 81 | 599/8 | 19 | 622/3 | 22 |
| 227/18 | 257 | 492/1 | 78 | 576/6 | 85 | 587/12 | 81 | 599/9 | 19 | 622/4 | 22 |
| 227/20 | 257 | 492/2 | 78 | 577/1 | 85 | 587/13 | 154 | 599/2/6000 | 19 | 622/5 | 22 |
| 227/22 | 257 | 493/1 | 76 | 577/2 | 85 | 587/14 | 81 | 599/3/6000 | 19 | 622/6 | 22 |
| 227/24 | 257 | 493/2 | 76 | 577/4 | 85 | 587/15 | 81 | 599/4/6000 | 19 | 622/4/S | 22 |
| 227/27 | 257 | 494/1 | 78 | 577/5 | 85 | 587/16 | 81 | 599/5/6000 | 19 | 622/5/S | 22 |
| 227/28 | 257 | 494/2 | 78 | 577/7 | 85 | 587/17 | 81 | 599/6/6000 | 19 | 622/5/S1 | 22 |
| 227/29 | 257 | 496/C1/C | 74 | 577/8 | 85 | 587/18 | 81 | 599/7/6000 | 19 | 622/5/S2 | 22 |
| 227/30 | 257 | 496/C2/C | 74 | 577/9 | 85 | 587/19 | 81 | 599/8/6000 | 19 | 622/1/6000 | 22 |
| 227/31 | 257 | 496/C3/C | 74 | 577/10 | 85 | 587/20 | 81 | 599/9/6000 | 19 | 622/3/6000 | 22 |
| 227/32 | 257 | 497/1/C | 74 | 578/1 | 85 | 587/22 | 81 | 600/1 | 19 | 622/4/6000 | 22 |
| 227/33 | 257 | 497/2/C | 74 | 578/2 | 85 | 587/24 | 81 | 600/2 | 19 | 622/5/6000 | 22 |
| 227/34 | 257 | 499/1/C | 72 | 578/3 | 85 | 587/25 | 81 | 600/3 | 19 | 622/6/6000 | 22 |
| 227/35 | 257 | 499/2/C | 72 | 578/4 | 85 | 587/26 | 81 | 600/4 | 19 | 622/4/S/6000 | 22 |
| 227/36 | 257 | 501/1 | 73 | 578/5 | 85 | 587/27 | 81 | 600/5 | 19 | 623/1 | 22 |
| 227/37 | 257 | 501/2 | 73 | 578/6 | 85 | 587/28 | 81 | 600/6 | 19 | 623/2 | 22 |
| 227/38 | 257 | 503/1 | 73 | 578/7 | 85 | 587/29 | 81 | 600/7 | 19 | 623/3 | 22 |
| 227/39 | 257 | 504/2/C | 73 | 578/8 | 85 | 587/30 | 81 | 600/8 | 19 | 623/4 | 21 |
| 227/40 | 257 | 504/3/C | 73 | 578/9 | 85 | 587/32 | 81 | 600/9 | 19 | 623/5 | 21 |
| 227/41 | 257 | 505/1 | 79 | 578/10 | 85 | 587/34 | 81 | 600/10 | 19 | 623/6 | 21 |
| 227/42 | 257 | 505/2 | 79 | 578/11 | 85 | 587/35 | 81 | 600/3/6000 | 19 | 623/7 | 21 |
| 227/43 | 257 | 505/3 | 79 | 578/12 | 85 | 587/36 | 81 | 600/4/6000 | 19 | 623/8 | 21 |
| 227/44 | 257 | 505/4 | 79 | 578/13 | 86 | 587/37 | 81 | 600/5/6000 | 19 | 623/9 | 21 |
| 227/45 | 257 | 507/1 | 76 | 578/14 | 86 | 587/38 | 81 | 600/6/6000 | 19 | 623/11 | 21 |
| 227/46 | 257 | 507/2 | 76 | 578/15 | 86 | 587/39 | 81 | 600/7/6000 | 19 | 623/12 | 22 |
| 227/47 | 257 | 508/1 | 78 | 578/16 | 86 | 587/40 | 81 | 600/8/6000 | 19 | 623/13 | 22 |
| 227/51 | 257 | 508/3/C | 74 | 578/17 | 86 | 587/42 | 80 | 600/9/6000 | 19 | 623/2/S | 22 |
| 227/52 | 257 | 508/4/C | 74 | 578/18 | 86 | 587/44 | 80 | 600/10/6000 | 19 | 623/1/6000 | 22 |
| 227/53 | 257 | 509/1 | 78 | 578/19 | 86 | 587/46 | 80 | 604/6 | 129 | 623/2/6000 | 22 |
| 227/54 | 257 | 510/1 | 110 | 578/20 | 86 | 587/48 | 80 | 605/1 | 45 | 623/3/6000 | 22 |
| 227/55 | 257 | 511/1 | 110 | 578/18/S1 | 157 | 589/4 | 159 | 605/2 | 45 | 623/4/6000 | 21 |
| 227/56 | 257 | 537/1 | 93 | 582/1 | 215 | 589/5 | 159 | 605/3 | 45 | 623/5/6000 | 21 |
| 227/57 | 257 | 537/2 | 93 | 584/1 | 96 | 591/1 | 160 | 605/4 | 45 | 623/6/6000 | 21 |
| 227/58 | 257 | 537/3 | 93 | 584/2 | 96 | 591/2 | 160 | 605/5 | 45 | 623/7/6000 | 21 |
| 446/4 | 188 | 537/8 | 92 | 584/4 | 96 | 591/3 | 160 | 605/6 | 45 | 623/8/6000 | 21 |
| 450/1 | 188 | 537/9 | 92 | 584/5 | 96 | 591/4 | 160 | 605/7 | 45 | 623/9/6000 | 21 |
| 452/1 | 188 | 539/2 | 111 | 584/6 | 110 | 593/10 | 183 | 605/8 | 45 | 623/11/6000 | 21 |
| 454/3 | 187 | 540/2 | 105 | 584/7 | 110 | 593/11 | 183 | 606/1 | 44 | 623/12/6000 | 22 |
| 455/2 | 188 | 541/1 | 106 | 584/A/4 | 96 | 593/3/S1 | 183 | 606/2 | 44 | 623/13/6000 | 22 |
| 459/1 | 189 | 541/2 | 106 | 584/A/5 | 96 | 593/3/S4 | 183 | 606/3 | 44 | 625/1 | 21 |
| 462/1 | 103 | 561/1 | 84 | 584/A/6 | 96 | 595/7/S | 55 | 606/4 | 44 | 625/2 | 21 |
| 462/2 | 103 | 561/2 | 84 | 584/B/1 | 96 | 596/4/S3 | 55 | 607/1 | 44 | 625/3 | 21 |
| 462/3 | 103 | 561/3 | 84 | 584/B/2 | 96 | 598/1 | 74 | 607/2 | 44 | 625/4 | 21 |
| 462/4 | 103 | 561/4 | 84 | 584/B/3 | 97 | 598/2 | 19 | 607/3 | 44 | 625/5 | 21 |
| 473/1 | 112 | 561/5 | 84 | 585/1 | 80 | 598/3 | 19 | 607/4 | 44 | 625/6 | 21 |
| 474/1 | 112 | 561/6 | 84 | 585/2 | 80 | 598/4 | 19 | 608/5 | 49 | 625/7 | 21 |
| 475/1 | 112 | 562/1 | 84 | 586/1 | 80 | 598/5 | 19 | 608/6 | 49 | 625/8 | 21 |
| 475/2 | 112 | 562/2 | 84 | 586/6 | 81 | 598/6 | 74 | 608/7 | 49 | 625/9 | 21 |
| 479/1 | 110 | 572/1 | 84 | 586/7 | 81 | 598/7 | 74 | 608/8 | 49 | 626/1 | 37 |
| 479/2 | 112 | 572/2 | 84 | 586/8 | 81 | 598/8 | 19 | 609/2 | 51 | 626/2 | 37 |
| 479/3 | 110 | 572/3 | 84 | 586/9 | 81 | 598/10 | 19 | 614/4 | 57 | 626/3 | 37 |
| 480/1 | 190 | 572/4 | 84 | 586/10 | 81 | 598/11 | 19 | 614/5 | 57 | 626/4 | 37 |
| 483/1 | 108 | 572/5 | 153 | 586/11 | 81 | 598/12 | 19 | 614/6 | 57 | 626/5 | 37 |
| 483/2 | 108 | 572/6 | 153 | 586/12 | 81 | 598/13 | 19 | 615/1 | 99 | 626/6 | 37 |
| 487/1 | 111 | 572/7 | 153 | 586/13 | 81 | 598/14 | 19 | 615/2 | 99 | 626/7 | 37 |
| 488/1 | 111 | 572/8 | 153 | 586/14 | 81 | 598/15 | 19 | 615/3 | 99 | 626/8 | 37 |
| 489/1 | 77 | 573/1 | 84 | 586/15 | 81 | 598/16 | 19 | 615/4 | 99 | 626/9 | 37 |
| 489/2 | 77 | 573/2 | 84 | 586/16 | 154 | 598/18 | 19 | 617/1 | 99 | 626/10 | 21 |
| 490/1 | 77 | 573/3 | 84 | 586/17 | 154 | 598/11/6000 | 19 | 617/2 | 99 | 626/12 | 21 |
| 490/2 | 77 | 573/4 | 84 | 586/9/1500 | 154 | 598/13/6000 | 19 | 617/3 | 99 | 626/13 | 21 |

Not all of the Arterferro items are available in **Arterferro Quick**, just a special selection.

Find out about the entire range in the catalogue

In **Arterferro Quick** non sono presenti tutti gli articoli Arterferro, ma solo una speciale selezione.

Scopri la gamma completa nel catalogo

Compendium

INDEX - INDICE

| | | | | | | | | | | | |
|-------------|-----|--------|-----|----------|-----|--------|-----|------------|-----|--------------|-----|
| 626/14 | 21 | 661/3 | 236 | 713/2 | 131 | 727/29 | 171 | 749/18 | 181 | 810/B/14/T | 30 |
| 626/15 | 21 | 661/4 | 236 | 714/1 | 150 | 727/30 | 171 | 749/19 | 181 | 810/B/15/T | 30 |
| 626/16 | 21 | 661/5 | 236 | 715/1 | 131 | 727/31 | 171 | 749/22 | 182 | 810/B/16/T | 30 |
| 626/10/6000 | 21 | 662/1 | 236 | 715/2 | 131 | 727/32 | 171 | 750/3 | 235 | 810/B/17/T | 30 |
| 626/12/6000 | 21 | 662/2 | 236 | 716/1 | 131 | 727/33 | 171 | 751/1 | 236 | 810/B/18/T | 30 |
| 626/13/6000 | 21 | 662/5 | 236 | 716/2 | 131 | 727/34 | 171 | 797/1 | 73 | 810/B/19/T | 30 |
| 626/14/6000 | 21 | 662/6 | 236 | 716/3 | 131 | 727/35 | 171 | 797/2 | 72 | 810/B/20/T | 30 |
| 626/15/6000 | 21 | 663/1 | 236 | 716/4 | 131 | 727/36 | 171 | 797/4 | 74 | 810/12/6000 | 26 |
| 626/16/6000 | 21 | 663/2 | 236 | 717/5/S1 | 131 | 727/37 | 171 | 797/5 | 73 | 810/13/6000 | 26 |
| 630/1 | 210 | 663/5 | 236 | 717/5/S3 | 131 | 737/1 | 220 | 797/6 | 72 | 810/7/C/6000 | 26 |
| 630/2 | 210 | 663/6 | 236 | 717/5/S4 | 131 | 737/2 | 220 | 797/7 | 72 | 810/8/C/6000 | 26 |
| 630/3 | 210 | 664/1 | 234 | 719/1 | 189 | 737/3 | 220 | 799/1 | 79 | 811/1 | 28 |
| 630/4 | 210 | 664/2 | 234 | 719/2 | 189 | 737/4 | 220 | 800/4 | 79 | 811/2 | 28 |
| 630/5 | 210 | 664/7 | 236 | 720/1 | 189 | 737/5 | 220 | 801/1 | 84 | 811/3 | 28 |
| 630/6 | 210 | 664/8 | 236 | 720/2 | 188 | 737/6 | 220 | 801/2 | 86 | 811/5 | 28 |
| 630/7 | 210 | 665/1 | 234 | 722/1 | 168 | 737/7 | 220 | 801/3 | 104 | 811/8 | 28 |
| 630/8 | 210 | 665/2 | 234 | 722/2 | 168 | 737/8 | 220 | 801/4 | 104 | 811/3/T | 30 |
| 630/9 | 210 | 666/2 | 235 | 722/3 | 167 | 738/1 | 220 | 801/5 | 86 | 811/4/T | 30 |
| 630/10 | 210 | 666/5 | 235 | 722/4 | 167 | 738/2 | 220 | 801/6 | 78 | 811/5/T | 30 |
| 630/11 | 210 | 666/6 | 235 | 722/5 | 166 | 738/3 | 220 | 801/7 | 84 | 811/6/T | 30 |
| 630/12 | 210 | 666/9 | 235 | 722/6 | 166 | 738/4 | 220 | 801/8 | 86 | 811/7/T | 30 |
| 630/13 | 210 | 673/2 | 236 | 722/7 | 175 | 738/5 | 220 | 802/1 | 77 | 811/8/T | 30 |
| 641/1 | 204 | 679/1 | 190 | 722/8 | 175 | 738/6 | 220 | 802/4 | 245 | 811/9/T | 30 |
| 641/2 | 204 | 679/2 | 190 | 723/5 | 174 | 738/7 | 220 | 802/5 | 245 | 811/10/T | 30 |
| 641/3 | 204 | 679/3 | 190 | 724/1 | 180 | 738/8 | 220 | 810/1 | 26 | 812/1 | 26 |
| 641/4 | 204 | 680/1 | 190 | 725/1 | 178 | 738/9 | 220 | 810/2 | 26 | 812/2 | 26 |
| 641/5 | 204 | 681/1 | 107 | 725/2 | 180 | 738/10 | 220 | 810/3 | 26 | 812/3 | 26 |
| 641/6 | 204 | 681/2 | 107 | 726/1 | 178 | 738/11 | 220 | 810/5 | 26 | 812/4 | 26 |
| 641/7 | 204 | 681/3 | 107 | 726/2 | 178 | 739/1 | 226 | 810/10 | 26 | 812/5 | 26 |
| 641/8 | 204 | 681/4 | 107 | 726/3 | 178 | 739/2 | 226 | 810/11 | 26 | 812/6 | 26 |
| 642/1 | 207 | 685/1 | 107 | 726/4 | 178 | 739/3 | 226 | 810/12 | 26 | 812/7 | 26 |
| 642/2 | 207 | 685/2 | 107 | 726/6 | 179 | 739/4 | 226 | 810/13 | 26 | 812/8 | 26 |
| 642/3 | 207 | 685/3 | 107 | 726/7 | 179 | 739/5 | 226 | 810/7/C | 26 | 812/9 | 29 |
| 642/4 | 207 | 685/4 | 107 | 726/9 | 180 | 739/6 | 226 | 810/8/C | 26 | 812/10 | 29 |
| 646/1 | 209 | 685/5 | 107 | 726/10 | 180 | 741/1 | 227 | 810/A/1 | 26 | 812/11 | 29 |
| 646/2 | 209 | 685/6 | 107 | 726/11 | 180 | 741/2 | 227 | 810/A/2 | 26 | 812/12 | 28 |
| 646/3 | 209 | 691/6 | 235 | 726/12 | 180 | 741/3 | 227 | 810/A/3 | 26 | 812/13 | 28 |
| 646/4 | 209 | 691/7 | 235 | 726/20 | 171 | 741/4 | 227 | 810/A/4 | 26 | 812/14 | 28 |
| 646/5 | 209 | 692/8 | 235 | 726/21 | 171 | 741/5 | 227 | 810/A/5 | 26 | 812/15 | 28 |
| 646/6 | 209 | 695/4 | 234 | 726/22 | 171 | 741/6 | 227 | 810/A/6 | 26 | 812/5/S | 26 |
| 646/7 | 209 | 695/6 | 248 | 726/23 | 171 | 741/7 | 227 | 810/A/7 | 26 | 812/6/S | 26 |
| 646/8 | 209 | 695/7 | 248 | 727/1 | 178 | 741/8 | 227 | 810/A/9 | 26 | 812/1/S4 | 26 |
| 653/1 | 65 | 695/8 | 248 | 727/2 | 178 | 742/1 | 223 | 810/A/10 | 26 | 812/1/S8 | 26 |
| 653/2 | 65 | 695/9 | 248 | 727/3 | 178 | 742/2 | 223 | 810/A/11 | 26 | 812/1/S9 | 26 |
| 653/3 | 65 | 695/10 | 248 | 727/4 | 178 | 742/3 | 223 | 810/A/12 | 26 | 812/12/S | 28 |
| 653/4 | 65 | 695/11 | 248 | 727/5 | 178 | 742/4 | 223 | 810/A/13 | 26 | 812/12/T | 30 |
| 653/5 | 66 | 696/1 | 70 | 727/6 | 178 | 742/5 | 223 | 810/A/14 | 26 | 812/13/T | 30 |
| 654/1 | 65 | 696/3 | 131 | 727/7 | 179 | 742/6 | 223 | 810/A/15 | 26 | 812/15/T | 30 |
| 654/2 | 66 | 697/1 | 234 | 727/8 | 179 | 747/12 | 224 | 810/A/16 | 26 | 812/16/S | 28 |
| 654/3 | 66 | 697/3 | 234 | 727/9 | 179 | 747/13 | 224 | 810/A/18 | 26 | 812/3/S1 | 26 |
| 654/4 | 66 | 697/4 | 234 | 727/10 | 180 | 747/14 | 224 | 810/A/23 | 26 | 812/3/S2 | 26 |
| 654/5 | 65 | 697/5 | 248 | 727/11 | 180 | 747/15 | 225 | 810/A/24 | 26 | 812/5/S1 | 26 |
| 655/1 | 208 | 697/7 | 248 | 727/12 | 171 | 747/16 | 225 | 810/B/19 | 28 | 812/5/S4 | 26 |
| 655/2 | 208 | 697/8 | 248 | 727/13 | 171 | 747/17 | 225 | 810/B/20 | 28 | 812/5/S6 | 26 |
| 655/3 | 208 | 700/1 | 235 | 727/14 | 171 | 747/18 | 224 | 810/B/1/T | 30 | 812/5/S8 | 26 |
| 655/4 | 208 | 700/4 | 235 | 727/15 | 171 | 747/19 | 224 | 810/B/2/T | 30 | 812/5/S9 | 26 |
| 655/5 | 208 | 700/5 | 235 | 727/16 | 171 | 747/20 | 224 | 810/B/3/T | 30 | 812/14/XL | 28 |
| 656/1 | 208 | 700/10 | 235 | 727/17 | 171 | 747/21 | 225 | 810/B/4/T | 30 | 812/5/S10 | 26 |
| 658/7 | 205 | 701/5 | 234 | 727/18 | 171 | 747/22 | 225 | 810/B/5/T | 30 | 812/8/S/2 | 26 |
| 658/8 | 205 | 701/6 | 235 | 727/19 | 171 | 747/23 | 225 | 810/B/6/T | 30 | 812/12/T/S | 30 |
| 659/10 | 205 | 705/1 | 234 | 727/20 | 171 | 749/1 | 181 | 810/B/7/T | 30 | 819/1 | 244 |
| 659/11 | 205 | 705/3 | 235 | 727/21 | 171 | 749/2 | 181 | 810/B/8/T | 30 | 819/2 | 244 |
| 660/10 | 234 | 705/5 | 235 | 727/22 | 171 | 749/8 | 181 | 810/1/6000 | 26 | 819/3 | 244 |
| 660/11 | 234 | 711/3 | 234 | 727/23 | 171 | 749/9 | 181 | 810/2/6000 | 26 | 819/4 | 244 |
| 660/12 | 234 | 711/5 | 234 | 727/25 | 171 | 749/10 | 181 | 810/A/19/T | 35 | 819/5 | 244 |
| 661/1 | 236 | 711/6 | 234 | 727/26 | 171 | 749/13 | 181 | 810/A/20/T | 35 | 819/6 | 244 |
| 661/2 | 236 | 713/1 | 131 | 727/28 | 171 | 749/14 | 181 | 810/B/13/T | 30 | 819/7 | 244 |

Not all of the Arterferro items are available in **Arterferro Quick**, just a special selection.

Find out about the entire range in the catalogue

In **Arterferro Quick** non sono presenti tutti gli articoli Arterferro, ma solo una speciale selezione.

Scopri la gamma completa nel catalogo

Compendium

INDEX - INDICE

| | | | | | | | | | | | |
|--------|-----|--------|-----|--------|-----|--------|-----|------------|-----|---------|-----|
| 819/8 | 244 | 840/2 | 254 | 851/6 | 240 | 876/11 | 261 | 1050/3 | 105 | 1138/8 | 85 |
| 819/9 | 244 | 840/3 | 254 | 851/7 | 240 | 877/1 | 261 | 1050/4 | 105 | 1138/9 | 85 |
| 819/10 | 244 | 840/4 | 254 | 851/8 | 240 | 877/2 | 261 | 1051/1 | 109 | 1138/10 | 85 |
| 819/11 | 244 | 840/5 | 254 | 851/9 | 240 | 877/3 | 261 | 1051/2 | 109 | 1148/2 | 94 |
| 819/12 | 218 | 840/6 | 254 | 851/10 | 240 | 877/4 | 261 | 1051/3 | 109 | 1148/3 | 94 |
| 819/13 | 218 | 841/7 | 245 | 851/11 | 241 | 877/5 | 261 | 1051/4 | 106 | 1148/5 | 94 |
| 819/14 | 218 | 849/1 | 258 | 851/12 | 241 | 877/6 | 261 | 1051/5 | 106 | 1148/6 | 94 |
| 819/15 | 244 | 849/2 | 258 | 851/14 | 241 | 877/7 | 261 | 1064/1 | 111 | 1148/8 | 94 |
| 819/16 | 244 | 849/3 | 258 | 851/15 | 241 | 877/8 | 261 | 1064/2 | 111 | 1148/9 | 94 |
| 819/17 | 244 | 849/4 | 258 | 851/16 | 241 | 878/1 | 262 | 1064/3 | 111 | 1148/11 | 94 |
| 819/18 | 244 | 850/1 | 240 | 851/17 | 241 | 878/2 | 262 | 1066/4 | 146 | 1148/12 | 94 |
| 830/1 | 255 | 850/2 | 240 | 851/18 | 241 | 878/3 | 262 | 1066/5 | 146 | 1148/14 | 94 |
| 830/2 | 255 | 850/3 | 240 | 852/1 | 241 | 878/4 | 262 | 1074/1 | 136 | 1148/15 | 94 |
| 830/3 | 255 | 850/4 | 240 | 852/2 | 241 | 878/5 | 262 | 1074/2 | 136 | 1148/17 | 94 |
| 830/7 | 255 | 850/5 | 240 | 852/4 | 238 | 878/6 | 262 | 1080/9 | 165 | 1148/18 | 94 |
| 830/10 | 255 | 850/6 | 240 | 852/5 | 238 | 878/7 | 262 | 1080/9/S1 | 165 | 1149/1 | 102 |
| 830/13 | 255 | 850/7 | 240 | 852/6 | 238 | 878/8 | 262 | 1080/9/S3 | 165 | 1149/2 | 102 |
| 830/15 | 255 | 850/8 | 240 | 852/7 | 238 | 879/2 | 262 | 1080/9/S4 | 165 | 1149/3 | 102 |
| 830/16 | 255 | 850/9 | 240 | 852/8 | 238 | 879/3 | 262 | 1080/9/S8 | 165 | 1149/4 | 102 |
| 830/17 | 255 | 850/10 | 240 | 852/10 | 238 | 880/1 | 263 | 1080/9/S9 | 165 | 1149/5 | 102 |
| 830/18 | 255 | 850/11 | 240 | 852/11 | 238 | 880/2 | 263 | 1080/9/200 | 165 | 1149/6 | 102 |
| 830/19 | 255 | 850/12 | 240 | 852/12 | 238 | 880/3 | 263 | 1080/9/S10 | 165 | 1149/7 | 104 |
| 830/20 | 255 | 850/13 | 240 | 852/13 | 238 | 880/4 | 263 | 1080/9/S11 | 165 | 1149/8 | 104 |
| 830/21 | 255 | 850/14 | 240 | 852/14 | 238 | 880/5 | 263 | 1080/9/S12 | 165 | 1150/3 | 103 |
| 831/1 | 250 | 850/15 | 240 | 852/15 | 238 | 881/1 | 263 | 1080/9/S13 | 165 | 1150/4 | 103 |
| 833/1 | 251 | 850/16 | 240 | 869/1 | 260 | 881/2 | 263 | 1080/9/S14 | 165 | 1150/7 | 103 |
| 833/2 | 251 | 850/17 | 240 | 869/2 | 260 | 881/3 | 263 | 1082/1 | 115 | 1150/8 | 103 |
| 833/3 | 251 | 850/18 | 240 | 870/1 | 260 | 881/4 | 263 | 1082/2 | 115 | 1151/1 | 102 |
| 833/4 | 250 | 850/19 | 240 | 870/2 | 260 | 881/5 | 263 | 1124/1 | 97 | 1151/2 | 102 |
| 833/6 | 251 | 850/20 | 240 | 870/3 | 260 | 881/6 | 263 | 1124/2 | 97 | 1151/3 | 102 |
| 834/1 | 251 | 850/21 | 240 | 870/4 | 260 | 881/7 | 263 | 1127/1 | 96 | 1151/4 | 102 |
| 834/2 | 253 | 850/22 | 240 | 871/1 | 260 | 881/8 | 263 | 1127/2 | 96 | 1151/5 | 94 |
| 834/3 | 251 | 850/23 | 240 | 872/1 | 260 | 881/9 | 263 | 1135/1 | 85 | 1151/6 | 94 |
| 835/1 | 252 | 850/24 | 240 | 872/2 | 260 | 882/1 | 263 | 1135/2 | 85 | 1151/7 | 94 |
| 835/2 | 252 | 850/25 | 240 | 872/3 | 260 | 882/2 | 263 | 1135/3 | 85 | 1158/5 | 153 |
| 835/3 | 252 | 850/26 | 240 | 872/4 | 260 | 882/3 | 263 | 1135/4 | 85 | 1158/6 | 153 |
| 835/4 | 252 | 850/27 | 240 | 872/5 | 260 | 882/40 | 264 | 1136/1 | 85 | 1158/8 | 155 |
| 835/5 | 252 | 850/28 | 240 | 872/6 | 260 | 883/1 | 263 | 1136/2 | 85 | 1163/1 | 230 |
| 835/6 | 250 | 850/29 | 240 | 872/7 | 260 | 883/3 | 263 | 1136/3 | 85 | 1163/2 | 230 |
| 835/7 | 250 | 850/30 | 240 | 872/8 | 260 | 883/4 | 263 | 1136/4 | 85 | 1163/3 | 230 |
| 835/8 | 250 | 850/31 | 240 | 872/9 | 260 | 1009/1 | 187 | 1136/5 | 85 | 1163/4 | 230 |
| 835/9 | 250 | 850/32 | 240 | 872/10 | 260 | 1009/2 | 187 | 1136/6 | 85 | 1163/5 | 230 |
| 836/1 | 250 | 850/33 | 240 | 872/11 | 260 | 1011/1 | 188 | 1136/7 | 85 | 1163/6 | 230 |
| 836/4 | 251 | 850/34 | 240 | 873/1 | 260 | 1013/1 | 187 | 1136/8 | 85 | 1163/7 | 230 |
| 837/2 | 252 | 850/35 | 240 | 873/2 | 260 | 1013/2 | 187 | 1136/9 | 85 | 1163/8 | 230 |
| 837/3 | 252 | 850/36 | 240 | 873/3 | 260 | 1014/1 | 187 | 1136/10 | 85 | 1163/10 | 231 |
| 837/4 | 256 | 850/37 | 240 | 874/1 | 261 | 1014/2 | 187 | 1137/1 | 84 | 1163/11 | 231 |
| 837/5 | 256 | 850/38 | 240 | 874/2 | 261 | 1014/3 | 187 | 1137/2 | 84 | 1163/12 | 231 |
| 837/7 | 256 | 850/39 | 240 | 874/3 | 261 | 1024/1 | 189 | 1137/3 | 84 | 1164/1 | 231 |
| 837/8 | 256 | 850/40 | 240 | 874/4 | 261 | 1038/1 | 108 | 1137/4 | 84 | 1164/2 | 231 |
| 837/9 | 256 | 850/41 | 240 | 874/5 | 261 | 1038/2 | 108 | 1137/5 | 84 | 1164/3 | 231 |
| 837/10 | 256 | 850/42 | 240 | 875/1 | 261 | 1039/1 | 108 | 1137/6 | 84 | 1164/4 | 231 |
| 838/1 | 251 | 850/43 | 240 | 875/2 | 261 | 1040/1 | 108 | 1137/7 | 84 | 1164/5 | 231 |
| 838/2 | 251 | 850/44 | 240 | 875/3 | 261 | 1043/2 | 148 | 1137/8 | 84 | 1165/5 | 183 |
| 838/3 | 251 | 850/45 | 240 | 875/4 | 261 | 1045/5 | 105 | 1137/9 | 84 | 1165/6 | 183 |
| 838/4 | 251 | 850/46 | 240 | 875/5 | 261 | 1045/6 | 105 | 1137/10 | 84 | 1166/1 | 130 |
| 839/1 | 252 | 850/47 | 240 | 875/6 | 261 | 1045/7 | 105 | 1137/11 | 157 | 1166/2 | 130 |
| 839/2 | 252 | 850/48 | 240 | 876/1 | 261 | 1045/8 | 105 | 1137/12 | 157 | 1166/3 | 130 |
| 839/3 | 252 | 850/49 | 240 | 876/2 | 261 | 1046/1 | 105 | 1137/13 | 157 | 1166/4 | 130 |
| 839/4 | 252 | 850/50 | 240 | 876/3 | 261 | 1046/2 | 105 | 1137/14 | 157 | 1167/1 | 130 |
| 839/5 | 253 | 850/51 | 240 | 876/4 | 261 | 1046/3 | 200 | 1138/1 | 84 | 1167/2 | 130 |
| 839/6 | 253 | 850/52 | 240 | 876/5 | 261 | 1046/4 | 200 | 1138/2 | 84 | 1167/3 | 130 |
| 839/7 | 253 | 851/1 | 240 | 876/6 | 261 | 1046/5 | 200 | 1138/3 | 84 | 1167/4 | 130 |
| 839/8 | 253 | 851/2 | 240 | 876/7 | 261 | 1046/6 | 200 | 1138/4 | 84 | 1170/1 | 129 |
| 839/9 | 253 | 851/3 | 240 | 876/8 | 261 | 1046/7 | 200 | 1138/5 | 84 | 1170/2 | 129 |
| 839/10 | 253 | 851/4 | 240 | 876/9 | 261 | 1049/1 | 109 | 1138/6 | 84 | 1170/5 | 129 |
| 840/1 | 254 | 851/5 | 240 | 876/10 | 261 | 1050/1 | 105 | 1138/7 | 85 | 1170/6 | 129 |

Not all of the Arterferro items are available in **Arterferro Quick**, just a special selection.

Find out about the entire range in the catalogue

In **Arterferro Quick** non sono presenti tutti gli articoli Arterferro, ma solo una speciale selezione.

Scopri la gamma completa nel catalogo

Compendium

INDEX - INDICE

| | | | | | | | | | | | |
|----------|-----|---------|-----|---------|-----|---------|-----|-----------|-----|---------|-----|
| 1171/1 | 129 | 1244/10 | 223 | 1260/44 | 167 | 1261/49 | 167 | 1263/5 | 167 | 1294/10 | 211 |
| 1171/2 | 130 | 1244/11 | 223 | 1260/45 | 167 | 1261/50 | 167 | 1263/6 | 167 | 1294/11 | 211 |
| 1176/1/S | 91 | 1244/12 | 223 | 1260/46 | 167 | 1261/51 | 167 | 1263/7 | 167 | 1294/12 | 211 |
| 1176/2/S | 91 | 1244/13 | 223 | 1260/47 | 167 | 1261/52 | 167 | 1263/8 | 167 | 1294/13 | 211 |
| 1176/3/S | 91 | 1244/14 | 223 | 1260/48 | 167 | 1261/53 | 167 | 1263/9 | 167 | 1294/14 | 211 |
| 1176/4/S | 91 | 1244/15 | 223 | 1260/49 | 167 | 1261/54 | 167 | 1263/10 | 167 | 1294/15 | 211 |
| 1177/1 | 91 | 1244/16 | 223 | 1260/50 | 167 | 1261/55 | 167 | 1263/11 | 167 | 1294/16 | 211 |
| 1177/2 | 91 | 1244/17 | 223 | 1260/51 | 167 | 1261/57 | 167 | 1263/12 | 167 | 1294/17 | 211 |
| 1177/3 | 91 | 1244/18 | 223 | 1260/52 | 167 | 1261/59 | 167 | 1263/13 | 166 | 1294/18 | 211 |
| 1177/4 | 91 | 1244/19 | 223 | 1260/53 | 167 | 1261/61 | 167 | 1263/14 | 166 | 1294/19 | 211 |
| 1177/5 | 91 | 1244/20 | 223 | 1260/54 | 167 | 1261/63 | 167 | 1263/15 | 166 | 1294/20 | 211 |
| 1177/6 | 91 | 1244/21 | 223 | 1260/55 | 167 | 1261/65 | 167 | 1263/16 | 166 | 1295/1 | 201 |
| 1177/7 | 91 | 1244/22 | 223 | 1260/57 | 167 | 1261/67 | 167 | 1263/17 | 166 | 1295/2 | 201 |
| 1177/8 | 91 | 1244/23 | 223 | 1260/59 | 167 | 1261/69 | 167 | 1263/18 | 166 | 1295/3 | 201 |
| 1177/9 | 91 | 1251/1 | 80 | 1260/61 | 167 | 1261/71 | 167 | 1263/19 | 166 | 1295/4 | 201 |
| 1177/10 | 91 | 1251/2 | 80 | 1260/63 | 167 | 1262/1 | 167 | 1263/20 | 166 | 1295/5 | 201 |
| 1179/1 | 91 | 1251/3 | 80 | 1260/65 | 167 | 1262/2 | 167 | 1263/21 | 166 | 1295/6 | 201 |
| 1179/2 | 91 | 1251/4 | 80 | 1260/67 | 167 | 1262/3 | 167 | 1263/22 | 166 | 1295/7 | 201 |
| 1179/3 | 91 | 1251/7 | 80 | 1260/69 | 167 | 1262/4 | 167 | 1263/23 | 166 | 1296/1 | 201 |
| 1179/4 | 91 | 1251/8 | 80 | 1260/71 | 167 | 1262/5 | 167 | 1263/24 | 166 | 1296/2 | 201 |
| 1184/1 | 73 | 1251/9 | 80 | 1261/1 | 168 | 1262/6 | 167 | 1263/25 | 167 | 1296/3 | 201 |
| 1184/2 | 73 | 1251/10 | 80 | 1261/2 | 168 | 1262/7 | 167 | 1263/26 | 167 | 1296/4 | 201 |
| 1184/3 | 75 | 1251/11 | 80 | 1261/3 | 167 | 1262/8 | 167 | 1263/27 | 166 | 1296/5 | 201 |
| 1184/5 | 73 | 1251/12 | 80 | 1261/4 | 168 | 1262/9 | 167 | 1263/28 | 166 | 1296/6 | 201 |
| 1184/6 | 73 | 1260/1 | 168 | 1261/5 | 168 | 1262/10 | 167 | 1263/29 | 166 | 1296/7 | 201 |
| 1185/1 | 75 | 1260/2 | 168 | 1261/6 | 168 | 1262/11 | 167 | 1263/30 | 166 | 1296/8 | 201 |
| 1185/2 | 73 | 1260/3 | 168 | 1261/7 | 168 | 1262/12 | 167 | 1263/31 | 166 | 1296/9 | 201 |
| 1185/4 | 73 | 1260/4 | 168 | 1261/8 | 168 | 1262/13 | 166 | 1263/32 | 166 | 1296/10 | 201 |
| 1187/3 | 74 | 1260/5 | 168 | 1261/9 | 168 | 1262/14 | 166 | 1264/5 | 155 | 1296/11 | 201 |
| 1187/4 | 75 | 1260/6 | 168 | 1261/10 | 168 | 1262/15 | 166 | 1267/9 | 158 | 1296/12 | 201 |
| 1199/2 | 79 | 1260/7 | 168 | 1261/11 | 168 | 1262/16 | 166 | 1268/52 | 158 | 1296/13 | 201 |
| 1199/3 | 74 | 1260/8 | 168 | 1261/12 | 168 | 1262/17 | 166 | 1268/53 | 158 | 1297/2 | 204 |
| 1203/1 | 104 | 1260/9 | 168 | 1261/13 | 168 | 1262/18 | 166 | 1269/7 | 160 | 1297/3 | 204 |
| 1203/2 | 104 | 1260/10 | 168 | 1261/14 | 168 | 1262/19 | 166 | 1269/11 | 160 | 1297/7 | 204 |
| 1204/1 | 104 | 1260/11 | 168 | 1261/15 | 168 | 1262/20 | 166 | 1270/29 | 155 | 1299/5 | 195 |
| 1205/1 | 91 | 1260/12 | 168 | 1261/16 | 168 | 1262/21 | 166 | 1271/3 | 158 | 1299/6 | 195 |
| 1205/2 | 91 | 1260/13 | 168 | 1261/17 | 168 | 1262/22 | 166 | 1271/4 | 158 | 1299/7 | 195 |
| 1229/1 | 92 | 1260/14 | 168 | 1261/18 | 168 | 1262/23 | 166 | 1271/5 | 158 | 1299/8 | 195 |
| 1229/2 | 92 | 1260/15 | 168 | 1261/19 | 166 | 1262/24 | 166 | 1276/1 | 159 | 1300/2 | 183 |
| 1229/3 | 93 | 1260/16 | 168 | 1261/20 | 166 | 1262/25 | 167 | 1279/3 | 69 | 1301/1 | 202 |
| 1229/4 | 92 | 1260/17 | 168 | 1261/21 | 166 | 1262/26 | 167 | 1279/4 | 69 | 1301/2 | 202 |
| 1229/5 | 92 | 1260/18 | 168 | 1261/22 | 166 | 1262/27 | 167 | 1281/1 | 68 | 1301/3 | 202 |
| 1230/2 | 93 | 1260/19 | 166 | 1261/23 | 166 | 1262/28 | 167 | 1281/2 | 68 | 1301/4 | 202 |
| 1230/4 | 93 | 1260/20 | 166 | 1261/24 | 166 | 1262/29 | 167 | 1281/3 | 68 | 1301/5 | 202 |
| 1231/1 | 92 | 1260/21 | 166 | 1261/25 | 166 | 1262/30 | 167 | 1281/4 | 68 | 1301/6 | 202 |
| 1231/2 | 92 | 1260/22 | 166 | 1261/26 | 166 | 1262/31 | 167 | 1281/5 | 67 | 1301/7 | 202 |
| 1243/1 | 221 | 1260/23 | 166 | 1261/27 | 166 | 1262/32 | 167 | 1281/6 | 67 | 1301/8 | 202 |
| 1243/2 | 221 | 1260/24 | 166 | 1261/28 | 166 | 1262/33 | 167 | 1281/7 | 67 | 1301/9 | 202 |
| 1243/3 | 221 | 1260/25 | 166 | 1261/29 | 166 | 1262/34 | 167 | 1281/8 | 67 | 1301/10 | 202 |
| 1243/4 | 221 | 1260/26 | 166 | 1261/30 | 166 | 1262/35 | 167 | 1281/9 | 67 | 1308/1 | 153 |
| 1243/5 | 221 | 1260/27 | 166 | 1261/31 | 166 | 1262/36 | 167 | 1281/10 | 67 | 1308/2 | 153 |
| 1243/6 | 221 | 1260/28 | 166 | 1261/32 | 166 | 1262/37 | 166 | 1281/11 | 67 | 1308/3 | 153 |
| 1243/7 | 221 | 1260/29 | 166 | 1261/33 | 166 | 1262/38 | 166 | 1281/12 | 67 | 1308/4 | 153 |
| 1243/8 | 221 | 1260/30 | 166 | 1261/34 | 166 | 1262/39 | 166 | 1281/13 | 70 | 1308/7 | 153 |
| 1243/9 | 221 | 1260/31 | 166 | 1261/35 | 166 | 1262/40 | 166 | 1281/14 | 70 | 1308/8 | 153 |
| 1243/10 | 221 | 1260/32 | 166 | 1261/36 | 166 | 1262/41 | 166 | 1281/1/S | 68 | 1308/9 | 153 |
| 1243/11 | 221 | 1260/33 | 166 | 1261/37 | 167 | 1262/42 | 166 | 1281/3/S | 68 | 1308/11 | 153 |
| 1243/12 | 221 | 1260/34 | 166 | 1261/38 | 167 | 1262/43 | 166 | 1281/2/S2 | 68 | 1308/12 | 153 |
| 1244/1 | 223 | 1260/35 | 166 | 1261/40 | 167 | 1262/44 | 166 | 1281/4/S2 | 68 | 1308/13 | 153 |
| 1244/2 | 223 | 1260/36 | 166 | 1261/41 | 167 | 1262/45 | 166 | 1290/1 | 207 | 1311/1 | 63 |
| 1244/3 | 223 | 1260/37 | 167 | 1261/42 | 167 | 1262/46 | 166 | 1290/2 | 207 | 1311/2 | 63 |
| 1244/4 | 223 | 1260/38 | 167 | 1261/43 | 167 | 1262/47 | 166 | 1290/3 | 207 | 1311/3 | 63 |
| 1244/5 | 223 | 1260/39 | 167 | 1261/44 | 167 | 1262/48 | 166 | 1291/1 | 207 | 1311/4 | 63 |
| 1244/6 | 223 | 1260/40 | 167 | 1261/45 | 167 | 1263/1 | 167 | 1291/2 | 207 | 1317/1 | 194 |
| 1244/7 | 223 | 1260/41 | 167 | 1261/46 | 167 | 1263/2 | 167 | 1291/3 | 207 | 1317/2 | 194 |
| 1244/8 | 223 | 1260/42 | 167 | 1261/47 | 167 | 1263/3 | 167 | 1291/4 | 207 | 1317/3 | 195 |
| 1244/9 | 223 | 1260/43 | 167 | 1261/48 | 167 | 1263/4 | 167 | 1291/5 | 207 | 1317/4 | 195 |

Not all of the Arterferro items are available in **Arterferro Quick**, just a special selection.

Find out about the entire range in the catalogue

In **Arterferro Quick** non sono presenti tutti gli articoli Arterferro, ma solo una speciale selezione.

Scopri la gamma completa nel catalogo

Compendium

INDEX - INDICE

| | | | | | | | | | | | |
|---------|-----|---------|-----|---------|----|--------------|----|----------------|----|--------------|----|
| 1317/5 | 195 | 1320/25 | 195 | 1368/27 | 17 | 1368/96 | 18 | 1368/60/6000 | 18 | 1370/17 | 20 |
| 1317/6 | 194 | 1320/26 | 195 | 1368/28 | 17 | 1368/97 | 18 | 1368/61/6000 | 18 | 1370/18 | 20 |
| 1317/7 | 194 | 1320/27 | 195 | 1368/29 | 17 | 1368/98 | 18 | 1368/62/6000 | 18 | 1370/19 | 20 |
| 1317/8 | 194 | 1320/28 | 195 | 1368/30 | 17 | 1368/99 | 18 | 1368/63/6000 | 18 | 1370/20 | 20 |
| 1317/9 | 194 | 1320/29 | 195 | 1368/31 | 17 | 1368/100 | 18 | 1368/64/6000 | 18 | 1370/21 | 20 |
| 1317/10 | 194 | 1320/30 | 195 | 1368/32 | 17 | 1368/101 | 18 | 1368/65/6000 | 18 | 1370/22 | 20 |
| 1317/11 | 194 | 1321/1 | 239 | 1368/33 | 17 | 1368/102 | 18 | 1368/66/6000 | 18 | 1370/23 | 20 |
| 1317/12 | 195 | 1321/2 | 239 | 1368/34 | 17 | 1368/103 | 18 | 1368/67/6000 | 18 | 1370/24 | 20 |
| 1317/13 | 195 | 1321/4 | 239 | 1368/35 | 17 | 1368/22/S | 17 | 1368/68/6000 | 18 | 1370/25 | 20 |
| 1317/14 | 195 | 1321/5 | 239 | 1368/37 | 18 | 1368/25/S | 17 | 1368/69/6000 | 18 | 1370/1/6000 | 35 |
| 1317/15 | 195 | 1321/6 | 239 | 1368/38 | 18 | 1368/1/6000 | 17 | 1368/70/6000 | 18 | 1370/2/6000 | 35 |
| 1317/16 | 195 | 1321/8 | 239 | 1368/39 | 18 | 1368/2/6000 | 17 | 1368/71/6000 | 18 | 1370/3/6000 | 35 |
| 1317/17 | 195 | 1321/9 | 195 | 1368/40 | 18 | 1368/3/6000 | 17 | 1368/72/6000 | 18 | 1370/4/6000 | 35 |
| 1317/18 | 195 | 1321/10 | 239 | 1368/41 | 18 | 1368/4/6000 | 17 | 1368/73/6000 | 18 | 1370/13/6000 | 20 |
| 1317/19 | 195 | 1321/11 | 195 | 1368/42 | 18 | 1368/5/6000 | 17 | 1368/74/6000 | 18 | 1370/14/6000 | 20 |
| 1317/20 | 195 | 1321/12 | 239 | 1368/43 | 18 | 1368/6/6000 | 17 | 1368/75/6000 | 18 | 1370/15/6000 | 20 |
| 1317/21 | 195 | 1328/3 | 235 | 1368/44 | 18 | 1368/7/6000 | 17 | 1368/76/6000 | 18 | 1370/16/6000 | 20 |
| 1317/22 | 195 | 1328/6 | 234 | 1368/45 | 18 | 1368/8/6000 | 17 | 1368/77/6000 | 18 | 1370/17/6000 | 20 |
| 1317/23 | 195 | 1358/1 | 59 | 1368/46 | 18 | 1368/9/6000 | 17 | 1368/78/6000 | 18 | 1370/18/6000 | 20 |
| 1317/24 | 194 | 1358/2 | 59 | 1368/47 | 18 | 1368/10/6000 | 17 | 1368/79/6000 | 18 | 1370/19/6000 | 20 |
| 1317/25 | 194 | 1360/1 | 45 | 1368/48 | 18 | 1368/11/6000 | 18 | 1368/80/6000 | 18 | 1370/20/6000 | 20 |
| 1317/27 | 194 | 1360/2 | 45 | 1368/49 | 18 | 1368/12/6000 | 18 | 1368/81/6000 | 18 | 1370/21/6000 | 20 |
| 1317/28 | 194 | 1360/3 | 45 | 1368/50 | 18 | 1368/13/6000 | 18 | 1368/82/6000 | 18 | 1370/22/6000 | 20 |
| 1318/1 | 195 | 1360/4 | 45 | 1368/51 | 18 | 1368/14/6000 | 18 | 1368/83/6000 | 18 | 1370/23/6000 | 20 |
| 1318/2 | 195 | 1360/5 | 45 | 1368/52 | 18 | 1368/15/6000 | 18 | 1368/84/6000 | 18 | 1370/24/6000 | 20 |
| 1318/3 | 195 | 1360/6 | 44 | 1368/53 | 18 | 1368/16/6000 | 18 | 1368/85/6000 | 18 | 1370/25/6000 | 20 |
| 1318/4 | 195 | 1360/7 | 45 | 1368/54 | 18 | 1368/17/6000 | 18 | 1368/86/6000 | 18 | 1373/1 | 35 |
| 1318/5 | 195 | 1360/8 | 52 | 1368/55 | 18 | 1368/18/6000 | 18 | 1368/87/6000 | 18 | 1373/2 | 26 |
| 1318/6 | 195 | 1360/9 | 52 | 1368/57 | 18 | 1368/19/6000 | 18 | 1368/88/6000 | 18 | 1373/3 | 26 |
| 1318/7 | 195 | 1360/10 | 52 | 1368/58 | 18 | 1368/20/6000 | 17 | 1368/89/6000 | 18 | 1373/4 | 26 |
| 1318/8 | 195 | 1360/11 | 52 | 1368/59 | 18 | 1368/21/6000 | 17 | 1368/90/6000 | 18 | 1373/1/6000 | 35 |
| 1318/9 | 195 | 1360/12 | 52 | 1368/60 | 18 | 1368/22/6000 | 17 | 1368/91/6000 | 18 | 1373/2/6000 | 26 |
| 1318/10 | 195 | 1360/13 | 52 | 1368/61 | 18 | 1368/23/6000 | 17 | 1368/92/6000 | 18 | 1373/3/6000 | 26 |
| 1318/11 | 195 | 1361/1 | 45 | 1368/62 | 18 | 1368/24/6000 | 17 | 1368/93/6000 | 18 | 1373/4/6000 | 26 |
| 1318/12 | 195 | 1361/2 | 45 | 1368/63 | 18 | 1368/25/6000 | 17 | 1368/94/6000 | 18 | 1374/1 | 24 |
| 1318/13 | 195 | 1361/3 | 45 | 1368/64 | 18 | 1368/26/6000 | 17 | 1368/95/6000 | 18 | 1374/2 | 24 |
| 1318/14 | 195 | 1361/4 | 45 | 1368/65 | 18 | 1368/27/6000 | 17 | 1368/96/6000 | 18 | 1374/3 | 24 |
| 1318/15 | 195 | 1361/5 | 45 | 1368/66 | 18 | 1368/28/6000 | 17 | 1368/97/6000 | 18 | 1374/4 | 24 |
| 1318/16 | 195 | 1361/6 | 45 | 1368/67 | 18 | 1368/29/6000 | 17 | 1368/98/6000 | 18 | 1374/5 | 24 |
| 1318/17 | 195 | 1361/7 | 45 | 1368/68 | 18 | 1368/30/6000 | 17 | 1368/99/6000 | 18 | 1374/6 | 24 |
| 1319/2 | 195 | 1361/8 | 45 | 1368/69 | 18 | 1368/31/6000 | 17 | 1368/100/6000 | 18 | 1374/7 | 24 |
| 1319/3 | 195 | 1368/1 | 17 | 1368/70 | 18 | 1368/32/6000 | 17 | 1368/101/6000 | 18 | 1374/8 | 24 |
| 1319/6 | 195 | 1368/2 | 17 | 1368/71 | 18 | 1368/33/6000 | 17 | 1368/102/6000 | 18 | 1374/9 | 24 |
| 1320/1 | 194 | 1368/3 | 17 | 1368/72 | 18 | 1368/34/6000 | 17 | 1368/103/6000 | 18 | 1374/10 | 24 |
| 1320/2 | 194 | 1368/4 | 17 | 1368/73 | 18 | 1368/35/6000 | 17 | 1368/22/S/6000 | 17 | 1374/11 | 24 |
| 1320/3 | 194 | 1368/5 | 17 | 1368/74 | 18 | 1368/37/6000 | 18 | 1368/23/6000/Z | 17 | 1374/12 | 24 |
| 1320/4 | 194 | 1368/6 | 17 | 1368/75 | 18 | 1368/38/6000 | 18 | 1368/25/S/6000 | 17 | 1374/13 | 24 |
| 1320/5 | 194 | 1368/7 | 17 | 1368/76 | 18 | 1368/39/6000 | 18 | 1369/1 | 22 | 1374/14 | 24 |
| 1320/6 | 194 | 1368/8 | 17 | 1368/77 | 18 | 1368/40/6000 | 18 | 1369/1/S | 22 | 1374/15 | 24 |
| 1320/7 | 194 | 1368/9 | 17 | 1368/78 | 18 | 1368/41/6000 | 18 | 1369/1/S1 | 22 | 1374/16 | 24 |
| 1320/8 | 194 | 1368/10 | 17 | 1368/79 | 18 | 1368/42/6000 | 18 | 1369/1/S2 | 22 | 1374/17 | 24 |
| 1320/9 | 194 | 1368/11 | 18 | 1368/80 | 18 | 1368/43/6000 | 18 | 1369/1/6000 | 22 | 1374/18 | 24 |
| 1320/10 | 194 | 1368/12 | 18 | 1368/81 | 18 | 1368/44/6000 | 18 | 1369/1/S/6000 | 22 | 1374/19 | 24 |
| 1320/11 | 194 | 1368/13 | 18 | 1368/82 | 18 | 1368/45/6000 | 18 | 1369/1/S1/6000 | 22 | 1374/20 | 24 |
| 1320/12 | 194 | 1368/14 | 18 | 1368/83 | 18 | 1368/46/6000 | 18 | 1369/1/S2/6000 | 22 | 1374/21 | 24 |
| 1320/13 | 195 | 1368/15 | 18 | 1368/84 | 18 | 1368/47/6000 | 18 | 1369/2 | 22 | 1374/22 | 24 |
| 1320/14 | 195 | 1368/16 | 18 | 1368/85 | 18 | 1368/48/6000 | 18 | 1369/2/6000 | 22 | 1374/23 | 24 |
| 1320/15 | 195 | 1368/17 | 18 | 1368/86 | 18 | 1368/49/6000 | 18 | 1370/1 | 35 | 1374/24 | 24 |
| 1320/16 | 195 | 1368/18 | 18 | 1368/87 | 18 | 1368/50/6000 | 18 | 1370/2 | 35 | 1374/25 | 24 |
| 1320/17 | 195 | 1368/19 | 18 | 1368/88 | 18 | 1368/51/6000 | 18 | 1370/3 | 35 | 1374/26 | 24 |
| 1320/18 | 195 | 1368/20 | 17 | 1368/89 | 18 | 1368/52/6000 | 18 | 1370/4 | 35 | 1374/27 | 24 |
| 1320/19 | 195 | 1368/21 | 17 | 1368/90 | 18 | 1368/53/6000 | 18 | 1370/11 | 75 | 1374/29 | 24 |
| 1320/20 | 195 | 1368/22 | 17 | 1368/91 | 18 | 1368/54/6000 | 18 | 1370/12 | 75 | 1374/30 | 24 |
| 1320/21 | 195 | 1368/23 | 17 | 1368/92 | 18 | 1368/55/6000 | 18 | 1370/13 | 20 | 1374/5/S | 25 |
| 1320/22 | 195 | 1368/24 | 17 | 1368/93 | 18 | 1368/57/6000 | 18 | 1370/14 | 20 | 1374/9/S | 25 |
| 1320/23 | 195 | 1368/25 | 17 | 1368/94 | 18 | 1368/58/6000 | 18 | 1370/15 | 20 | 1374/13/S | 24 |
| 1320/24 | 195 | 1368/26 | 17 | 1368/95 | 18 | 1368/59/6000 | 18 | 1370/16 | 20 | 1374/2/S1 | 25 |

Not all of the Arterferro items are available in **Arterferro Quick**, just a special selection.

Find out about the entire range in the catalogue

In **Arterferro Quick** non sono presenti tutti gli articoli Arterferro, ma solo una speciale selezione.

Scopri la gamma completa nel catalogo

Compendium

INDEX - INDICE

| | | | | | | | | | | | |
|------------|-----|---------|-----|---------|-----|---------|-----|---------|-----|---------|-----|
| 1374/2/S2 | 25 | 1380/2 | 176 | 1391/11 | 228 | 1395/6 | 218 | 1411/9 | 239 | 1414/15 | 240 |
| 1374/3/S2 | 25 | 1381/1 | 176 | 1391/12 | 228 | 1395/7 | 218 | 1412/1 | 240 | 1414/16 | 240 |
| 1374/3/S4 | 25 | 1381/2 | 176 | 1391/13 | 228 | 1395/8 | 218 | 1412/2 | 240 | 1414/17 | 240 |
| 1374/4/S1 | 25 | 1381/3 | 176 | 1391/14 | 228 | 1395/9 | 218 | 1412/3 | 240 | 1414/18 | 240 |
| 1374/9/S1 | 25 | 1381/7 | 176 | 1391/15 | 228 | 1395/10 | 218 | 1412/4 | 240 | 1414/19 | 240 |
| 1374/10/S2 | 25 | 1381/8 | 176 | 1391/16 | 228 | 1396/1 | 218 | 1412/5 | 240 | 1414/20 | 240 |
| 1374/10/S3 | 25 | 1381/9 | 176 | 1391/17 | 228 | 1396/2 | 218 | 1412/6 | 240 | 1414/21 | 240 |
| 1374/10/S4 | 24 | 1382/1 | 163 | 1391/18 | 228 | 1396/3 | 218 | 1412/7 | 240 | 1414/22 | 241 |
| 1374/10/S6 | 25 | 1382/2 | 163 | 1391/19 | 228 | 1396/4 | 218 | 1412/8 | 240 | 1470/8 | 245 |
| 1374/11/S1 | 25 | 1382/3 | 163 | 1391/20 | 228 | 1396/5 | 218 | 1412/9 | 240 | 1470/9 | 245 |
| 1374/11/S2 | 25 | 1382/4 | 163 | 1391/21 | 228 | 1398/1 | 182 | 1412/10 | 240 | 1474/1 | 252 |
| 1374/11/S3 | 25 | 1382/5 | 163 | 1391/22 | 228 | 1398/2 | 182 | 1412/11 | 240 | 1474/2 | 252 |
| 1374/11/S4 | 25 | 1382/6 | 163 | 1391/23 | 228 | 1399/1 | 182 | 1412/12 | 240 | 1474/3 | 252 |
| 1374/11/S5 | 24 | 1382/7 | 163 | 1392/1 | 224 | 1400/1 | 182 | 1412/13 | 240 | 1474/4 | 252 |
| 1374/12/S1 | 25 | 1382/8 | 163 | 1392/3 | 225 | 1400/2 | 182 | 1412/14 | 240 | 1474/5 | 251 |
| 1374/12/S2 | 25 | 1382/13 | 176 | 1392/4 | 225 | 1404/1 | 181 | 1412/15 | 240 | 1474/6 | 248 |
| 1374/12/S4 | 25 | 1382/14 | 176 | 1392/5 | 226 | 1404/2 | 181 | 1412/16 | 240 | 1474/7 | 248 |
| 1374/15/S2 | 25 | 1382/19 | 176 | 1392/6 | 226 | 1404/3 | 181 | 1412/17 | 240 | 1474/8 | 248 |
| 1377/5 | 28 | 1382/20 | 176 | 1392/7 | 226 | 1404/4 | 181 | 1412/18 | 240 | 1474/9 | 248 |
| 1377/11 | 26 | 1385/1 | 175 | 1393/2 | 186 | 1404/5 | 181 | 1412/19 | 240 | 1474/10 | 248 |
| 1377/18 | 28 | 1385/2 | 175 | 1393/4 | 234 | 1404/6 | 181 | 1412/20 | 240 | 1475/7 | 251 |
| 1377/23 | 26 | 1385/3 | 175 | 1393/5 | 234 | 1404/7 | 181 | 1412/21 | 240 | 1559/1 | 262 |
| 1377/40 | 28 | 1385/4 | 167 | 1393/6 | 234 | 1404/8 | 181 | 1412/22 | 240 | 1559/2 | 262 |
| 1377/41 | 28 | 1385/5 | 167 | 1393/7 | 245 | 1404/9 | 181 | 1412/23 | 240 | 1641/1 | 189 |
| 1377/42 | 28 | 1385/6 | 175 | 1393/10 | 227 | 1405/1 | 247 | 1412/24 | 240 | 1641/2 | 189 |
| 1377/1/T | 30 | 1385/7 | 166 | 1393/11 | 227 | 1405/2 | 247 | 1412/25 | 240 | 1641/5 | 189 |
| 1377/2/T | 30 | 1385/8 | 166 | 1393/12 | 227 | 1405/3 | 247 | 1412/26 | 240 | 1641/6 | 189 |
| 1377/3/T | 30 | 1385/9 | 175 | 1393/13 | 227 | 1408/1 | 245 | 1412/27 | 241 | 1647/3 | 112 |
| 1377/4/T | 30 | 1385/10 | 167 | 1393/14 | 227 | 1408/3 | 245 | 1412/28 | 241 | 1657/1 | 189 |
| 1377/5/T | 30 | 1385/11 | 167 | 1393/15 | 227 | 1408/4 | 245 | 1413/1 | 240 | 1657/4 | 189 |
| 1377/7/T | 30 | 1385/12 | 175 | 1393/16 | 227 | 1408/5 | 244 | 1413/2 | 240 | 1658/1 | 191 |
| 1377/8/T | 30 | 1385/13 | 166 | 1393/18 | 225 | 1408/6 | 244 | 1413/4 | 240 | 1658/2 | 191 |
| 1377/9/T | 30 | 1385/14 | 166 | 1393/19 | 225 | 1408/7 | 244 | 1413/5 | 240 | 1659/1 | 188 |
| 1377/10/T | 30 | 1385/15 | 175 | 1393/23 | 226 | 1408/8 | 244 | 1413/6 | 240 | 1665/1 | 212 |
| 1377/14/T | 30 | 1385/16 | 175 | 1393/24 | 226 | 1408/9 | 244 | 1413/7 | 240 | 1665/2 | 212 |
| 1377/15/T | 30 | 1385/17 | 175 | 1393/25 | 225 | 1408/10 | 244 | 1413/8 | 240 | 1665/3 | 212 |
| 1377/16/T | 30 | 1386/1 | 180 | 1393/26 | 225 | 1408/11 | 244 | 1413/9 | 240 | 1665/4 | 212 |
| 1377/17/T | 30 | 1386/2 | 180 | 1393/27 | 225 | 1408/12 | 244 | 1413/10 | 240 | 1665/5 | 212 |
| 1377/18/T | 30 | 1386/3 | 180 | 1393/28 | 225 | 1408/13 | 244 | 1413/11 | 240 | 1665/6 | 212 |
| 1377/20/T | 30 | 1386/4 | 180 | 1394/2 | 218 | 1408/14 | 244 | 1413/12 | 240 | 1665/7 | 212 |
| 1377/21/T | 30 | 1386/5 | 178 | 1394/3 | 218 | 1408/15 | 244 | 1413/13 | 240 | 1665/8 | 212 |
| 1377/22/T | 30 | 1386/6 | 178 | 1394/4 | 218 | 1408/16 | 244 | 1413/14 | 240 | 1665/9 | 212 |
| 1377/41/T | 30 | 1386/7 | 179 | 1394/6 | 218 | 1408/17 | 244 | 1413/15 | 240 | 1665/10 | 212 |
| 1377/42/T | 30 | 1386/8 | 179 | 1394/7 | 218 | 1408/18 | 244 | 1413/16 | 240 | 1665/11 | 212 |
| 1378/1 | 34 | 1386/10 | 179 | 1394/8 | 218 | 1408/19 | 244 | 1413/17 | 240 | 1665/12 | 212 |
| 1378/2 | 32 | 1386/11 | 178 | 1394/9 | 218 | 1408/20 | 244 | 1413/18 | 240 | 1665/13 | 212 |
| 1378/3 | 34 | 1386/12 | 178 | 1394/10 | 218 | 1408/21 | 244 | 1413/19 | 240 | 1665/14 | 212 |
| 1378/4 | 34 | 1386/13 | 178 | 1394/11 | 218 | 1409/1 | 239 | 1413/20 | 240 | 1665/15 | 212 |
| 1378/5 | 34 | 1387/1 | 179 | 1394/12 | 218 | 1409/2 | 239 | 1413/21 | 240 | 1665/16 | 212 |
| 1378/6 | 32 | 1387/2 | 179 | 1394/13 | 218 | 1409/3 | 239 | 1413/22 | 240 | 1665/17 | 212 |
| 1378/7 | 34 | 1387/3 | 179 | 1394/14 | 218 | 1409/4 | 239 | 1413/23 | 240 | 1665/18 | 212 |
| 1378/8 | 34 | 1389/1 | 220 | 1394/15 | 218 | 1409/5 | 239 | 1413/24 | 240 | 1667/2 | 188 |
| 1378/9 | 32 | 1389/2 | 220 | 1394/16 | 218 | 1409/6 | 239 | 1413/25 | 240 | 1670/1 | 106 |
| 1378/10 | 34 | 1389/3 | 220 | 1394/17 | 218 | 1410/1 | 239 | 1413/26 | 240 | 1670/2 | 106 |
| 1378/11 | 32 | 1389/4 | 220 | 1394/18 | 218 | 1410/2 | 239 | 1414/1 | 240 | 1671/1 | 106 |
| 1378/12 | 34 | 1389/5 | 220 | 1394/19 | 218 | 1410/3 | 239 | 1414/2 | 240 | 1671/2 | 106 |
| 1378/13 | 34 | 1389/6 | 220 | 1394/20 | 218 | 1410/4 | 239 | 1414/3 | 240 | 1671/3 | 106 |
| 1378/14 | 34 | 1391/1 | 228 | 1394/21 | 218 | 1410/5 | 239 | 1414/4 | 240 | 1671/4 | 106 |
| 1378/15 | 32 | 1391/2 | 228 | 1394/22 | 218 | 1410/6 | 239 | 1414/5 | 240 | 1671/6 | 106 |
| 1378/16 | 34 | 1391/3 | 228 | 1394/23 | 218 | 1411/1 | 239 | 1414/6 | 240 | 1678/2 | 111 |
| 1378/17 | 34 | 1391/4 | 228 | 1394/24 | 218 | 1411/2 | 239 | 1414/7 | 240 | 1680/2 | 137 |
| 1378/18 | 32 | 1391/5 | 228 | 1394/25 | 218 | 1411/3 | 239 | 1414/8 | 240 | 1681/1 | 137 |
| 1378/2/S | 32 | 1391/6 | 228 | 1395/1 | 218 | 1411/4 | 239 | 1414/9 | 240 | 1682/1 | 142 |
| 1378/5/S | 26 | 1391/7 | 228 | 1395/2 | 218 | 1411/5 | 239 | 1414/10 | 240 | 1685/3 | 144 |
| 1378/14/S | 26 | 1391/8 | 228 | 1395/3 | 218 | 1411/6 | 239 | 1414/12 | 240 | 1688/3 | 98 |
| 1378/11/S1 | 32 | 1391/9 | 228 | 1395/4 | 218 | 1411/7 | 239 | 1414/13 | 240 | 1688/4 | 98 |
| 1380/1 | 176 | 1391/10 | 228 | 1395/5 | 218 | 1411/8 | 239 | 1414/14 | 240 | 1695/1 | 98 |

Not all of the Arteferro items are available in **Arteferro Quick**, just a special selection.

Find out about the entire range in the catalogue

In **Arteferro Quick** non sono presenti tutti gli articoli Arteferro, ma solo una speciale selezione.

Scopri la gamma completa nel catalogo

Compendium

INDEX - INDICE

| | | | | | | | | | | | |
|---------|-----|---------|----|---------|-----|---------|-----|---------|-----|---------|-----|
| 1695/2 | 98 | 1709/10 | 82 | 1716/11 | 83 | 1724/31 | 100 | 1729/7 | 88 | 1757/9 | 162 |
| 1695/3 | 98 | 1709/11 | 82 | 1716/12 | 83 | 1724/32 | 100 | 1729/8 | 88 | 1757/10 | 162 |
| 1695/4 | 98 | 1709/12 | 82 | 1716/13 | 82 | 1724/33 | 100 | 1729/11 | 88 | 1757/11 | 162 |
| 1695/5 | 98 | 1709/13 | 87 | 1716/14 | 82 | 1724/34 | 100 | 1729/12 | 88 | 1757/12 | 162 |
| 1695/6 | 98 | 1709/14 | 87 | 1716/15 | 82 | 1724/35 | 100 | 1730/1 | 89 | 1757/13 | 162 |
| 1701/1 | 82 | 1709/15 | 87 | 1716/16 | 82 | 1724/36 | 100 | 1730/2 | 89 | 1757/14 | 162 |
| 1701/2 | 82 | 1709/16 | 87 | 1716/17 | 82 | 1724/37 | 100 | 1730/3 | 89 | 1757/15 | 162 |
| 1701/3 | 82 | 1709/17 | 87 | 1716/18 | 82 | 1724/38 | 100 | 1730/4 | 89 | 1757/16 | 162 |
| 1701/5 | 82 | 1709/18 | 87 | 1716/19 | 82 | 1724/39 | 100 | 1730/5 | 89 | 1757/17 | 162 |
| 1701/7 | 82 | 1709/19 | 87 | 1716/20 | 82 | 1724/40 | 100 | 1730/6 | 89 | 1757/18 | 162 |
| 1701/8 | 82 | 1709/20 | 87 | 1716/21 | 82 | 1724/41 | 100 | 1730/7 | 89 | 1757/19 | 162 |
| 1701/9 | 82 | 1709/21 | 87 | 1716/22 | 82 | 1724/42 | 100 | 1730/8 | 89 | 1757/20 | 162 |
| 1701/10 | 82 | 1709/22 | 82 | 1716/23 | 82 | 1724/43 | 100 | 1730/9 | 88 | 1757/21 | 162 |
| 1701/11 | 82 | 1709/23 | 87 | 1716/24 | 82 | 1724/44 | 100 | 1730/10 | 88 | 1757/22 | 162 |
| 1701/12 | 82 | 1709/24 | 82 | 1718/1 | 90 | 1724/45 | 100 | 1730/11 | 88 | 1757/23 | 162 |
| 1701/13 | 156 | 1710/1 | 83 | 1718/2 | 90 | 1724/46 | 100 | 1730/12 | 88 | 1757/24 | 162 |
| 1701/14 | 82 | 1710/2 | 83 | 1718/3 | 90 | 1724/47 | 100 | 1730/13 | 88 | 1757/25 | 162 |
| 1701/15 | 82 | 1710/3 | 83 | 1718/4 | 90 | 1724/48 | 100 | 1730/14 | 88 | 1757/26 | 162 |
| 1702/1 | 87 | 1710/4 | 82 | 1718/5 | 90 | 1724/49 | 100 | 1730/15 | 88 | 1757/27 | 162 |
| 1702/2 | 87 | 1710/5 | 83 | 1718/6 | 90 | 1724/50 | 100 | 1730/16 | 88 | 1757/28 | 162 |
| 1702/3 | 87 | 1710/7 | 83 | 1718/7 | 90 | 1724/51 | 100 | 1730/17 | 88 | 1757/29 | 162 |
| 1702/4 | 87 | 1710/8 | 83 | 1718/8 | 90 | 1724/52 | 100 | 1733/1 | 83 | 1757/30 | 162 |
| 1702/5 | 87 | 1710/9 | 83 | 1718/9 | 90 | 1724/53 | 100 | 1733/2 | 83 | 1757/31 | 162 |
| 1702/6 | 87 | 1710/10 | 83 | 1718/10 | 90 | 1724/54 | 100 | 1733/4 | 83 | 1757/32 | 162 |
| 1702/7 | 87 | 1710/11 | 83 | 1718/11 | 90 | 1724/55 | 100 | 1733/5 | 87 | 1757/33 | 162 |
| 1702/8 | 87 | 1710/12 | 83 | 1718/12 | 90 | 1724/56 | 100 | 1733/6 | 87 | 1757/34 | 162 |
| 1702/9 | 87 | 1710/13 | 82 | 1718/13 | 90 | 1724/57 | 100 | 1733/7 | 87 | 1757/35 | 162 |
| 1702/10 | 87 | 1710/14 | 82 | 1718/14 | 90 | 1724/58 | 100 | 1733/8 | 87 | 1757/36 | 162 |
| 1702/11 | 87 | 1710/17 | 82 | 1718/15 | 90 | 1724/59 | 100 | 1733/9 | 82 | 1757/37 | 162 |
| 1702/12 | 87 | 1710/19 | 82 | 1718/16 | 90 | 1724/60 | 100 | 1733/11 | 82 | 1757/38 | 162 |
| 1702/13 | 87 | 1710/20 | 82 | 1718/17 | 90 | 1724/61 | 100 | 1733/12 | 82 | 1757/39 | 162 |
| 1702/14 | 87 | 1710/21 | 82 | 1722/1 | 170 | 1724/62 | 100 | 1733/13 | 88 | 1757/40 | 162 |
| 1702/15 | 87 | 1710/23 | 82 | 1722/2 | 170 | 1725/1 | 100 | 1733/14 | 88 | 1757/41 | 162 |
| 1705/1 | 83 | 1713/1 | 87 | 1722/3 | 170 | 1725/2 | 100 | 1733/15 | 88 | 1757/42 | 162 |
| 1705/2 | 83 | 1713/2 | 87 | 1722/4 | 170 | 1725/3 | 100 | 1733/16 | 88 | 1757/43 | 162 |
| 1705/3 | 83 | 1713/3 | 87 | 1723/3 | 94 | 1725/4 | 100 | 1733/17 | 102 | 1757/44 | 162 |
| 1705/4 | 83 | 1713/4 | 87 | 1723/4 | 94 | 1725/5 | 100 | 1733/18 | 102 | 1757/45 | 162 |
| 1705/5 | 83 | 1713/5 | 87 | 1724/1 | 100 | 1725/6 | 100 | 1733/19 | 102 | 1757/49 | 162 |
| 1705/6 | 83 | 1713/6 | 87 | 1724/2 | 100 | 1725/7 | 100 | 1733/20 | 102 | 1757/50 | 162 |
| 1705/7 | 83 | 1713/7 | 87 | 1724/3 | 100 | 1725/8 | 100 | 1734/1 | 86 | 1757/51 | 162 |
| 1705/8 | 83 | 1713/8 | 87 | 1724/4 | 100 | 1725/9 | 100 | 1734/2 | 86 | 1757/52 | 162 |
| 1705/9 | 83 | 1713/9 | 87 | 1724/5 | 100 | 1725/10 | 100 | 1746/1 | 91 | 1757/53 | 162 |
| 1705/10 | 83 | 1713/10 | 87 | 1724/6 | 100 | 1725/11 | 100 | 1746/2 | 91 | 1757/54 | 162 |
| 1705/11 | 83 | 1713/11 | 87 | 1724/7 | 100 | 1725/12 | 100 | 1746/3 | 91 | 1757/55 | 162 |
| 1705/12 | 83 | 1713/12 | 87 | 1724/8 | 100 | 1725/13 | 100 | 1746/4 | 91 | 1757/56 | 162 |
| 1705/13 | 156 | 1714/1 | 87 | 1724/9 | 100 | 1725/14 | 100 | 1746/5 | 91 | 1757/57 | 162 |
| 1705/14 | 83 | 1714/2 | 87 | 1724/10 | 100 | 1725/15 | 100 | 1746/6 | 91 | 1757/58 | 162 |
| 1705/15 | 83 | 1714/3 | 87 | 1724/11 | 100 | 1725/16 | 100 | 1749/9 | 80 | 1757/59 | 162 |
| 1707/1 | 83 | 1714/4 | 87 | 1724/12 | 100 | 1725/17 | 100 | 1749/10 | 80 | 1757/60 | 162 |
| 1707/2 | 83 | 1714/5 | 87 | 1724/13 | 100 | 1725/18 | 100 | 1749/11 | 80 | 1757/61 | 162 |
| 1707/3 | 83 | 1714/6 | 87 | 1724/14 | 100 | 1725/19 | 100 | 1749/12 | 80 | 1757/62 | 162 |
| 1707/4 | 83 | 1714/7 | 87 | 1724/15 | 100 | 1725/20 | 100 | 1751/5 | 95 | 1757/63 | 162 |
| 1707/5 | 83 | 1714/8 | 87 | 1724/16 | 100 | 1725/21 | 100 | 1753/1 | 97 | 1757/64 | 162 |
| 1707/6 | 83 | 1714/9 | 87 | 1724/17 | 100 | 1725/22 | 100 | 1753/2 | 110 | 1757/65 | 162 |
| 1707/7 | 83 | 1714/10 | 87 | 1724/18 | 100 | 1725/23 | 100 | 1753/6 | 111 | 1757/66 | 162 |
| 1707/8 | 83 | 1714/11 | 87 | 1724/19 | 100 | 1725/24 | 100 | 1753/7 | 97 | 1757/67 | 162 |
| 1707/9 | 83 | 1714/12 | 87 | 1724/20 | 100 | 1727/1 | 88 | 1754/45 | 176 | 1757/68 | 162 |
| 1707/10 | 83 | 1716/1 | 83 | 1724/21 | 100 | 1727/2 | 88 | 1754/46 | 176 | 1757/69 | 162 |
| 1707/11 | 83 | 1716/2 | 83 | 1724/22 | 100 | 1727/3 | 88 | 1754/47 | 176 | 1757/70 | 162 |
| 1707/12 | 83 | 1716/3 | 83 | 1724/23 | 100 | 1727/4 | 88 | 1757/1 | 162 | 1757/71 | 162 |
| 1709/1 | 82 | 1716/4 | 83 | 1724/24 | 100 | 1727/7 | 88 | 1757/2 | 162 | 1757/72 | 162 |
| 1709/2 | 82 | 1716/5 | 83 | 1724/25 | 100 | 1727/8 | 88 | 1757/3 | 162 | 1757/73 | 162 |
| 1709/3 | 82 | 1716/6 | 83 | 1724/26 | 100 | 1729/1 | 88 | 1757/4 | 162 | 1757/74 | 162 |
| 1709/5 | 82 | 1716/7 | 83 | 1724/27 | 100 | 1729/2 | 88 | 1757/5 | 162 | 1757/75 | 162 |
| 1709/7 | 82 | 1716/8 | 83 | 1724/28 | 100 | 1729/3 | 88 | 1757/6 | 162 | 1757/76 | 162 |
| 1709/8 | 82 | 1716/9 | 83 | 1724/29 | 100 | 1729/4 | 88 | 1757/7 | 162 | 1757/77 | 162 |
| 1709/9 | 82 | 1716/10 | 83 | 1724/30 | 100 | 1729/6 | 88 | 1757/8 | 162 | 1757/78 | 162 |

Not all of the Arterferro items are available in **Arterferro Quick**, just a special selection.

Find out about the entire range in the catalogue

In **Arterferro Quick** non sono presenti tutti gli articoli Arterferro, ma solo una speciale selezione.

Scopri la gamma completa nel catalogo

Compendium

INDEX - INDICE

| | | | | | | | | | | | |
|---------|-----|---------|-----|----------|-----|---------|-----|--------------|-----|----------|-----|
| 1758/1 | 162 | 1764/4 | 169 | 1764/71 | 169 | 1770/8 | 79 | 1783/2 | 152 | 1802/38 | 194 |
| 1758/2 | 162 | 1764/5 | 169 | 1764/72 | 169 | 1770/9 | 74 | 1783/3 | 152 | 1802/39 | 194 |
| 1758/3 | 162 | 1764/6 | 169 | 1764/73 | 169 | 1770/10 | 74 | 1783/4 | 152 | 1802/40 | 194 |
| 1758/4 | 162 | 1764/7 | 169 | 1764/74 | 169 | 1770/11 | 76 | 1783/5 | 152 | 1802/41 | 194 |
| 1758/5 | 162 | 1764/8 | 169 | 1764/75 | 169 | 1770/12 | 76 | 1783/6 | 152 | 1802/42 | 194 |
| 1758/6 | 162 | 1764/9 | 169 | 1764/76 | 169 | 1770/13 | 78 | 1783/7 | 152 | 1802/43 | 194 |
| 1758/7 | 162 | 1764/10 | 169 | 1764/77 | 169 | 1770/14 | 78 | 1784/1 | 155 | 1802/44 | 194 |
| 1758/8 | 162 | 1764/11 | 169 | 1764/78 | 169 | 1770/15 | 78 | 1784/2 | 155 | 1802/45 | 194 |
| 1758/9 | 162 | 1764/12 | 169 | 1764/79 | 169 | 1770/16 | 78 | 1784/3 | 155 | 1802/46 | 194 |
| 1758/10 | 162 | 1764/13 | 169 | 1764/80 | 169 | 1771/1 | 73 | 1784/4 | 155 | 1802/47 | 194 |
| 1758/11 | 162 | 1764/14 | 169 | 1764/81 | 169 | 1771/2 | 72 | 1784/5 | 156 | 1802/48 | 194 |
| 1758/12 | 162 | 1764/15 | 169 | 1764/82 | 169 | 1771/3 | 72 | 1784/6 | 156 | 1802/49 | 194 |
| 1758/13 | 162 | 1764/16 | 169 | 1764/83 | 169 | 1771/5 | 75 | 1784/9 | 156 | 1802/50 | 194 |
| 1758/14 | 162 | 1764/17 | 169 | 1764/84 | 169 | 1771/8 | 79 | 1784/7/S | 156 | 1802/51 | 194 |
| 1758/15 | 162 | 1764/18 | 169 | 1764/85 | 169 | 1773/1 | 79 | 1785/1 | 160 | 1802/52 | 194 |
| 1758/16 | 162 | 1764/19 | 169 | 1764/86 | 169 | 1773/2 | 79 | 1785/5 | 160 | 1802/53 | 194 |
| 1758/17 | 162 | 1764/20 | 169 | 1764/87 | 169 | 1773/5 | 79 | 1787/4 | 159 | 1802/54 | 194 |
| 1758/18 | 162 | 1764/21 | 169 | 1764/88 | 169 | 1773/6 | 79 | 1787/9 | 159 | 1802/55 | 194 |
| 1758/19 | 162 | 1764/22 | 169 | 1764/89 | 169 | 1775/1 | 81 | 1789/3 | 159 | 1802/56 | 194 |
| 1758/20 | 162 | 1764/23 | 169 | 1764/90 | 169 | 1775/2 | 81 | 1789/4 | 159 | 1802/57 | 194 |
| 1758/21 | 162 | 1764/24 | 169 | 1764/91 | 169 | 1775/6 | 81 | 1793/7 | 222 | 1802/58 | 194 |
| 1758/22 | 162 | 1764/25 | 169 | 1764/92 | 169 | 1775/7 | 88 | 1793/8 | 222 | 1802/59 | 194 |
| 1758/23 | 162 | 1764/26 | 169 | 1764/93 | 169 | 1775/8 | 88 | 1794/3 | 93 | 1802/60 | 194 |
| 1758/24 | 162 | 1764/27 | 169 | 1764/94 | 169 | 1775/11 | 81 | 1794/4 | 93 | 1802/61 | 194 |
| 1758/25 | 162 | 1764/28 | 169 | 1764/95 | 169 | 1775/12 | 81 | 1794/5 | 93 | 1802/62 | 194 |
| 1758/26 | 162 | 1764/29 | 169 | 1764/96 | 169 | 1777/1 | 83 | 1794/6 | 93 | 1802/63 | 194 |
| 1758/27 | 162 | 1764/30 | 169 | 1764/97 | 169 | 1777/2 | 82 | 1794/9 | 37 | 1802/64 | 194 |
| 1758/28 | 162 | 1764/31 | 169 | 1764/98 | 169 | 1777/3 | 87 | 1794/9/6000 | 37 | 1802/65 | 194 |
| 1758/29 | 162 | 1764/32 | 169 | 1764/99 | 169 | 1777/4 | 83 | 1794/10 | 37 | 1802/66 | 194 |
| 1758/30 | 162 | 1764/33 | 169 | 1764/100 | 169 | 1777/5 | 87 | 1794/10/6000 | 37 | 1802/67 | 194 |
| 1758/31 | 162 | 1764/34 | 169 | 1764/101 | 169 | 1777/6 | 82 | 1802/1 | 194 | 1802/68 | 194 |
| 1758/32 | 162 | 1764/35 | 169 | 1764/102 | 169 | 1777/7 | 82 | 1802/2 | 194 | 1802/69 | 194 |
| 1758/33 | 162 | 1764/36 | 169 | 1765/2 | 175 | 1777/8 | 87 | 1802/3 | 194 | 1802/70 | 194 |
| 1758/34 | 162 | 1764/37 | 169 | 1765/3 | 175 | 1777/9 | 83 | 1802/4 | 194 | 1802/71 | 194 |
| 1758/35 | 162 | 1764/38 | 169 | 1765/4 | 175 | 1779/7 | 157 | 1802/5 | 194 | 1802/72 | 194 |
| 1758/36 | 162 | 1764/39 | 169 | 1765/11 | 175 | 1779/8 | 157 | 1802/6 | 194 | 1802/73 | 194 |
| 1758/37 | 162 | 1764/40 | 169 | 1765/16 | 175 | 1779/9 | 83 | 1802/7 | 194 | 1802/74 | 194 |
| 1758/38 | 162 | 1764/41 | 169 | 1765/21 | 175 | 1779/10 | 83 | 1802/8 | 194 | 1802/75 | 194 |
| 1758/39 | 162 | 1764/42 | 169 | 1765/26 | 175 | 1779/11 | 87 | 1802/9 | 194 | 1802/76 | 194 |
| 1758/40 | 162 | 1764/43 | 169 | 1765/31 | 175 | 1779/12 | 87 | 1802/10 | 194 | 1802/77 | 194 |
| 1758/41 | 162 | 1764/44 | 169 | 1765/36 | 175 | 1779/13 | 82 | 1802/11 | 194 | 1802/78 | 194 |
| 1758/42 | 162 | 1764/45 | 169 | 1765/41 | 175 | 1779/14 | 82 | 1802/12 | 194 | 1802/79 | 194 |
| 1758/43 | 162 | 1764/46 | 169 | 1765/46 | 175 | 1779/15 | 157 | 1802/13 | 194 | 1802/80 | 194 |
| 1758/44 | 162 | 1764/47 | 169 | 1765/51 | 175 | 1779/16 | 157 | 1802/14 | 194 | 1802/81 | 194 |
| 1758/45 | 162 | 1764/48 | 169 | 1766/33 | 176 | 1780/1 | 83 | 1802/15 | 194 | 1802/82 | 194 |
| 1758/46 | 162 | 1764/49 | 169 | 1766/34 | 176 | 1780/2 | 83 | 1802/16 | 194 | 1802/83 | 194 |
| 1758/47 | 162 | 1764/50 | 169 | 1766/35 | 176 | 1780/3 | 87 | 1802/17 | 194 | 1802/84 | 194 |
| 1758/48 | 162 | 1764/51 | 169 | 1766/36 | 176 | 1780/4 | 87 | 1802/18 | 194 | 1802/85 | 194 |
| 1758/49 | 162 | 1764/52 | 169 | 1766/37 | 176 | 1780/5 | 82 | 1802/19 | 194 | 1802/86 | 194 |
| 1758/50 | 162 | 1764/53 | 169 | 1766/38 | 176 | 1780/6 | 82 | 1802/20 | 194 | 1802/87 | 194 |
| 1758/51 | 162 | 1764/54 | 169 | 1766/39 | 176 | 1780/7 | 157 | 1802/21 | 194 | 1802/88 | 194 |
| 1758/52 | 162 | 1764/55 | 169 | 1766/40 | 176 | 1780/8 | 157 | 1802/22 | 194 | 1802/89 | 194 |
| 1758/53 | 162 | 1764/56 | 169 | 1766/41 | 176 | 1780/9 | 83 | 1802/23 | 194 | 1802/90 | 194 |
| 1758/54 | 162 | 1764/57 | 169 | 1766/42 | 176 | 1780/10 | 83 | 1802/24 | 194 | 1802/91 | 194 |
| 1758/55 | 162 | 1764/58 | 169 | 1766/43 | 176 | 1780/11 | 87 | 1802/25 | 194 | 1802/92 | 194 |
| 1758/56 | 162 | 1764/59 | 169 | 1766/44 | 176 | 1780/12 | 87 | 1802/26 | 194 | 1802/93 | 194 |
| 1758/57 | 162 | 1764/60 | 169 | 1769/1 | 75 | 1780/13 | 82 | 1802/27 | 194 | 1802/94 | 194 |
| 1758/58 | 162 | 1764/61 | 169 | 1769/2 | 75 | 1780/14 | 82 | 1802/28 | 194 | 1802/95 | 194 |
| 1758/59 | 162 | 1764/62 | 169 | 1769/3 | 75 | 1780/15 | 157 | 1802/29 | 194 | 1802/96 | 194 |
| 1758/60 | 162 | 1764/63 | 169 | 1769/5 | 75 | 1780/16 | 157 | 1802/30 | 194 | 1802/97 | 194 |
| 1758/61 | 162 | 1764/64 | 169 | 1769/6 | 75 | 1782/1 | 155 | 1802/31 | 194 | 1802/98 | 194 |
| 1759/45 | 176 | 1764/65 | 169 | 1769/7 | 78 | 1782/2 | 155 | 1802/32 | 194 | 1802/99 | 194 |
| 1759/46 | 176 | 1764/66 | 169 | 1769/8 | 78 | 1782/3 | 155 | 1802/33 | 194 | 1802/100 | 194 |
| 1759/47 | 176 | 1764/67 | 169 | 1770/1 | 73 | 1782/4 | 155 | 1802/34 | 194 | 1802/101 | 194 |
| 1764/1 | 169 | 1764/68 | 169 | 1770/2 | 72 | 1782/5 | 155 | 1802/35 | 194 | 1802/102 | 194 |
| 1764/2 | 169 | 1764/69 | 169 | 1770/3 | 72 | 1782/9 | 155 | 1802/36 | 194 | 1802/103 | 194 |
| 1764/3 | 169 | 1764/70 | 169 | 1770/5 | 75 | 1783/1 | 152 | 1802/37 | 194 | 1802/104 | 194 |

Not all of the Arterferro items are available in **Arterferro Quick**, just a special selection.

Find out about the entire range in the catalogue

In **Arterferro Quick** non sono presenti tutti gli articoli Arterferro, ma solo una speciale selezione.

Scopri la gamma completa nel catalogo

Compendium

INDEX - INDICE

| | | | | | | | | | | | |
|----------|-----|-----------|-----|------------|----|----------------|----|---------------|----|-----------------|----|
| 1802/105 | 194 | 1807/19 | 36 | 1819/27 | 26 | 1825/25 | 31 | 1839/2 | 22 | 1839/18/S6000 | 22 |
| 1802/106 | 194 | 1807/20 | 36 | 1819/28 | 26 | 1825/27 | 31 | 1839/3 | 22 | 1839/20/S6000 | 22 |
| 1802/107 | 194 | 1807/21 | 36 | 1819/29 | 26 | 1825/28 | 31 | 1839/4 | 22 | 1839/20/S3/6000 | 22 |
| 1802/108 | 194 | 1807/22 | 36 | 1819/30 | 26 | 1827/1 | 64 | 1839/5 | 23 | 1841/1 | 20 |
| 1802/109 | 194 | 1807/23 | 36 | 1819/13/S | 26 | 1827/3 | 64 | 1839/6 | 23 | 1841/2 | 20 |
| 1802/110 | 194 | 1807/24 | 36 | 1819/17/S | 26 | 1827/5 | 64 | 1839/7 | 23 | 1841/3 | 20 |
| 1802/111 | 194 | 1813/1 | 238 | 1819/20/S | 26 | 1827/7 | 64 | 1839/8 | 23 | 1841/4 | 20 |
| 1802/112 | 194 | 1813/2 | 238 | 1819/24/S | 26 | 1827/9 | 64 | 1839/9 | 23 | 1841/5 | 20 |
| 1802/113 | 194 | 1813/6 | 238 | 1819/28/S | 26 | 1827/11 | 64 | 1839/10 | 23 | 1841/6 | 20 |
| 1802/114 | 194 | 1814/2 | 29 | 1819/24/S1 | 26 | 1834/1 | 35 | 1839/11 | 23 | 1841/7 | 20 |
| 1802/115 | 194 | 1814/3 | 27 | 1819/24/S2 | 26 | 1834/2 | 35 | 1839/12 | 23 | 1841/30 | 20 |
| 1803/1 | 195 | 1814/4 | 27 | 1819/28/S1 | 26 | 1834/3 | 35 | 1839/13 | 23 | 1841/31 | 20 |
| 1803/2 | 195 | 1814/5 | 27 | 1820/1 | 30 | 1834/4 | 35 | 1839/14 | 23 | 1841/32 | 20 |
| 1803/3 | 195 | 1814/6 | 27 | 1820/2 | 30 | 1834/5 | 35 | 1839/15 | 22 | 1841/33 | 20 |
| 1803/4 | 194 | 1814/8 | 29 | 1820/3 | 30 | 1834/6 | 35 | 1839/16 | 22 | 1841/34 | 20 |
| 1803/5 | 194 | 1814/9 | 27 | 1820/4 | 30 | 1834/7 | 35 | 1839/17 | 22 | 1841/35 | 20 |
| 1803/6 | 194 | 1814/10 | 27 | 1820/5 | 30 | 1834/8 | 35 | 1839/18 | 22 | 1841/36 | 20 |
| 1803/7 | 194 | 1814/11 | 27 | 1820/6 | 30 | 1834/9 | 35 | 1839/19 | 22 | 1845/16 | 46 |
| 1803/8 | 194 | 1814/12 | 27 | 1820/7 | 30 | 1834/1/6000 | 35 | 1839/20 | 22 | 1845/17 | 46 |
| 1806/1 | 21 | 1814/14 | 29 | 1820/8 | 30 | 1834/2/6000 | 35 | 1839/21 | 22 | 1845/18 | 46 |
| 1806/2 | 21 | 1814/15 | 27 | 1820/9 | 30 | 1834/3/6000 | 35 | 1839/22 | 22 | 1845/19 | 46 |
| 1806/3 | 21 | 1814/16 | 27 | 1820/10 | 30 | 1834/4/6000 | 35 | 1839/23 | 22 | 1845/20 | 46 |
| 1806/4 | 21 | 1814/17 | 27 | 1820/11 | 30 | 1834/5/6000 | 35 | 1839/24 | 22 | 1845/21 | 46 |
| 1806/5 | 21 | 1814/18 | 27 | 1820/12 | 30 | 1834/6/6000 | 35 | 1839/25 | 35 | 1845/22 | 46 |
| 1806/6 | 21 | 1817/1 | 26 | 1820/13 | 30 | 1834/7/6000 | 35 | 1839/26 | 22 | 1845/23 | 46 |
| 1806/7 | 21 | 1817/2 | 26 | 1820/14 | 30 | 1834/8/6000 | 35 | 1839/1/S | 22 | 1845/24 | 46 |
| 1806/8 | 21 | 1817/3 | 26 | 1820/11/XL | 30 | 1834/9/6000 | 35 | 1839/14/S | 23 | 1845/25 | 46 |
| 1806/9 | 21 | 1817/4 | 28 | 1822/1 | 26 | 1837/1 | 35 | 1839/18/S | 22 | 1845/26 | 46 |
| 1806/10 | 21 | 1817/5 | 26 | 1822/2 | 26 | 1837/2 | 35 | 1839/19/S | 22 | 1845/27 | 46 |
| 1806/11 | 21 | 1817/7 | 28 | 1822/3 | 26 | 1837/3 | 35 | 1839/18/S1 | 22 | 1846/1 | 59 |
| 1806/12 | 21 | 1817/8 | 26 | 1822/4 | 26 | 1837/4 | 35 | 1839/18/S2 | 22 | 1846/3 | 41 |
| 1806/13 | 36 | 1817/9 | 26 | 1822/5 | 28 | 1837/5 | 35 | 1839/18/S3 | 22 | 1848/1 | 38 |
| 1806/14 | 36 | 1817/9/S5 | 26 | 1822/6 | 28 | 1837/6 | 35 | 1839/18/S4 | 22 | 1848/2 | 38 |
| 1806/15 | 36 | 1817/9/XL | 27 | 1822/7 | 28 | 1837/8 | 32 | 1839/19/S1 | 22 | 1848/3 | 38 |
| 1806/16 | 36 | 1818/1 | 32 | 1822/8 | 28 | 1837/1/6000 | 35 | 1839/20/S1 | 22 | 1848/4 | 38 |
| 1806/17 | 36 | 1818/2 | 32 | 1822/10 | 31 | 1837/2/6000 | 35 | 1839/20/S2 | 22 | 1848/5 | 38 |
| 1806/18 | 36 | 1818/3 | 32 | 1822/12 | 26 | 1837/3/6000 | 35 | 1839/20/S3 | 22 | 1848/6 | 38 |
| 1806/19 | 36 | 1818/4 | 32 | 1822/13 | 26 | 1837/4/6000 | 35 | 1839/20/S4 | 22 | 1848/7 | 39 |
| 1806/20 | 36 | 1818/5 | 28 | 1822/14 | 26 | 1837/6/6000 | 35 | 1839/1/6000 | 22 | 1848/8 | 39 |
| 1806/21 | 36 | 1818/6 | 28 | 1822/15 | 26 | 1838/2 | 22 | 1839/2/6000 | 22 | 1848/9 | 39 |
| 1806/22 | 36 | 1818/7 | 32 | 1822/16 | 28 | 1838/3 | 22 | 1839/3/6000 | 22 | 1848/10 | 39 |
| 1806/23 | 36 | 1818/8 | 32 | 1822/18 | 28 | 1838/4 | 22 | 1839/4/6000 | 22 | 1848/11 | 39 |
| 1806/24 | 36 | 1818/9 | 32 | 1822/19 | 28 | 1838/5 | 22 | 1839/5/6000 | 23 | 1848/12 | 39 |
| 1806/25 | 36 | 1818/10 | 32 | 1822/21 | 31 | 1838/6 | 22 | 1839/6/6000 | 23 | 1848/13 | 39 |
| 1806/26 | 36 | 1818/11 | 32 | 1825/2 | 33 | 1838/7 | 22 | 1839/7/6000 | 23 | 1848/14 | 39 |
| 1806/27 | 36 | 1818/12 | 32 | 1825/3 | 33 | 1838/8 | 35 | 1839/8/6000 | 23 | 1848/15 | 39 |
| 1806/28 | 36 | 1818/13 | 32 | 1825/4 | 33 | 1838/2/S1 | 22 | 1839/9/6000 | 23 | 1848/16 | 39 |
| 1806/29 | 36 | 1818/14 | 32 | 1825/5 | 33 | 1838/3/S1 | 22 | 1839/10/6000 | 23 | 1848/17 | 39 |
| 1806/30 | 36 | 1818/15 | 28 | 1825/6 | 33 | 1838/3/S2 | 22 | 1839/11/6000 | 23 | 1848/18 | 39 |
| 1807/1 | 36 | 1818/16 | 28 | 1825/7 | 33 | 1838/3/S4 | 22 | 1839/12/6000 | 23 | 1848/19 | 39 |
| 1807/2 | 36 | 1818/11/S | 32 | 1825/8 | 33 | 1838/3/S5 | 22 | 1839/13/6000 | 23 | 1848/20 | 39 |
| 1807/3 | 36 | 1819/5 | 28 | 1825/9 | 31 | 1838/3/S6 | 22 | 1839/14/6000 | 23 | 1848/21 | 39 |
| 1807/4 | 36 | 1819/10 | 28 | 1825/10 | 31 | 1838/3/S7 | 22 | 1839/15/6000 | 22 | 1851/1 | 40 |
| 1807/5 | 36 | 1819/12 | 28 | 1825/11 | 31 | 1838/4/S1 | 22 | 1839/15/S/L6 | 22 | 1851/2 | 40 |
| 1807/6 | 36 | 1819/13 | 26 | 1825/12 | 31 | 1838/2/6000 | 22 | 1839/16/6000 | 22 | 1851/3 | 40 |
| 1807/7 | 36 | 1819/14 | 26 | 1825/13 | 31 | 1838/3/6000 | 22 | 1839/17/6000 | 22 | 1851/4 | 40 |
| 1807/8 | 36 | 1819/15 | 26 | 1825/14 | 31 | 1838/4/6000 | 22 | 1839/18/6000 | 22 | 1851/5 | 40 |
| 1807/9 | 36 | 1819/16 | 26 | 1825/15 | 31 | 1838/5/6000 | 22 | 1839/19/50X6 | 22 | 1851/6 | 40 |
| 1807/10 | 36 | 1819/17 | 26 | 1825/16 | 31 | 1838/6/6000 | 22 | 1839/19/6000 | 22 | 1851/7 | 40 |
| 1807/11 | 36 | 1819/19 | 26 | 1825/17 | 31 | 1838/7/6000 | 22 | 1839/19/60X6 | 22 | 1851/8 | 40 |
| 1807/12 | 36 | 1819/20 | 26 | 1825/18 | 31 | 1838/8/6000 | 35 | 1839/20/6000 | 22 | 1851/9 | 40 |
| 1807/13 | 36 | 1819/21 | 26 | 1825/19 | 31 | 1838/4/S1/L6 | 22 | 1839/21/6000 | 22 | 1851/10 | 40 |
| 1807/14 | 36 | 1819/22 | 26 | 1825/20 | 31 | 1838/2/S/3000 | 22 | 1839/22/6000 | 22 | 1851/11 | 40 |
| 1807/15 | 36 | 1819/23 | 26 | 1825/21 | 31 | 1838/2/S/6000 | 22 | 1839/23/6000 | 22 | 1851/12 | 40 |
| 1807/16 | 36 | 1819/24 | 26 | 1825/22 | 31 | 1838/5/S/6000 | 22 | 1839/24/6000 | 22 | 1851/13 | 40 |
| 1807/17 | 36 | 1819/25 | 26 | 1825/23 | 31 | 1838/2/S1/6000 | 22 | 1839/26/6000 | 22 | 1851/14 | 41 |
| 1807/18 | 36 | 1819/26 | 26 | 1825/24 | 31 | 1839/1 | 22 | 1839/1/S/6000 | 22 | 1851/15 | 41 |

Not all of the Arteferro items are available in **Arteferro Quick**, just a special selection.

Find out about the entire range in the catalogue

In **Arteferro Quick** non sono presenti tutti gli articoli Arteferro, ma solo una speciale selezione.

Scopri la gamma completa nel catalogo

Compendium

INDEX - INDICE

| | | | | | | | | | | | |
|------------|----|----------|----|---------|----|----------|----|----------|----|----------|-----|
| 1851/16 | 41 | 1852/53 | 53 | 1853/16 | 49 | 1853/83 | 50 | 1853/150 | 48 | 1853/218 | 51 |
| 1851/18 | 41 | 1852/54 | 53 | 1853/17 | 49 | 1853/84 | 50 | 1853/151 | 48 | 1853/219 | 51 |
| 1851/18/S1 | 41 | 1852/55 | 53 | 1853/18 | 49 | 1853/85 | 50 | 1853/152 | 48 | 1853/220 | 51 |
| 1851/19 | 41 | 1852/56 | 53 | 1853/19 | 49 | 1853/86 | 50 | 1853/153 | 48 | 1853/221 | 51 |
| 1851/20 | 41 | 1852/57 | 53 | 1853/20 | 49 | 1853/87 | 50 | 1853/154 | 48 | 1853/222 | 51 |
| 1851/21 | 41 | 1852/58 | 53 | 1853/21 | 49 | 1853/88 | 50 | 1853/155 | 48 | 1853/223 | 51 |
| 1851/22 | 41 | 1852/59 | 53 | 1853/22 | 49 | 1853/89 | 50 | 1853/156 | 48 | 1853/224 | 51 |
| 1851/23 | 41 | 1852/60 | 53 | 1853/23 | 49 | 1853/90 | 50 | 1853/157 | 48 | 1853/225 | 51 |
| 1851/24 | 41 | 1852/61 | 53 | 1853/24 | 49 | 1853/91 | 50 | 1853/158 | 48 | 1853/226 | 51 |
| 1851/25 | 41 | 1852/62 | 53 | 1853/25 | 49 | 1853/92 | 50 | 1853/159 | 51 | 1853/227 | 51 |
| 1851/26 | 40 | 1852/63 | 53 | 1853/26 | 49 | 1853/93 | 50 | 1853/160 | 51 | 1853/228 | 51 |
| 1851/27 | 40 | 1852/64 | 53 | 1853/27 | 49 | 1853/94 | 50 | 1853/161 | 51 | 1853/229 | 51 |
| 1851/28 | 40 | 1852/65 | 53 | 1853/28 | 49 | 1853/95 | 50 | 1853/162 | 51 | 1853/230 | 51 |
| 1851/29 | 40 | 1852/66 | 53 | 1853/29 | 49 | 1853/96 | 50 | 1853/163 | 51 | 1854/1 | 226 |
| 1851/30 | 40 | 1852/67 | 53 | 1853/30 | 49 | 1853/97 | 50 | 1853/164 | 51 | 1854/2 | 226 |
| 1852/1 | 56 | 1852/68 | 53 | 1853/31 | 49 | 1853/98 | 50 | 1853/165 | 51 | 1854/3 | 226 |
| 1852/2 | 56 | 1852/69 | 53 | 1853/32 | 49 | 1853/99 | 50 | 1853/166 | 51 | 1854/7 | 174 |
| 1852/3 | 56 | 1852/70 | 53 | 1853/33 | 49 | 1853/100 | 50 | 1853/167 | 51 | 1854/8 | 174 |
| 1852/4 | 56 | 1852/71 | 53 | 1853/34 | 49 | 1853/101 | 50 | 1853/168 | 51 | 1854/9 | 174 |
| 1852/5 | 56 | 1852/72 | 53 | 1853/35 | 49 | 1853/102 | 50 | 1853/169 | 51 | 1854/10 | 174 |
| 1852/6 | 56 | 1852/73 | 53 | 1853/36 | 49 | 1853/103 | 50 | 1853/170 | 51 | 1855/1 | 179 |
| 1852/7 | 56 | 1852/74 | 53 | 1853/37 | 49 | 1853/104 | 50 | 1853/171 | 51 | 1855/2 | 179 |
| 1852/8 | 56 | 1852/75 | 53 | 1853/38 | 49 | 1853/105 | 48 | 1853/172 | 51 | 1855/3 | 179 |
| 1852/9 | 56 | 1852/76 | 53 | 1853/39 | 49 | 1853/106 | 48 | 1853/173 | 51 | 1855/4 | 179 |
| 1852/10 | 56 | 1852/77 | 53 | 1853/40 | 49 | 1853/107 | 48 | 1853/174 | 51 | 1855/5 | 179 |
| 1852/11 | 56 | 1852/78 | 53 | 1853/41 | 49 | 1853/108 | 48 | 1853/175 | 51 | 1855/8 | 178 |
| 1852/12 | 56 | 1852/79 | 53 | 1853/42 | 49 | 1853/109 | 48 | 1853/176 | 51 | 1855/9 | 178 |
| 1852/13 | 56 | 1852/80 | 53 | 1853/43 | 49 | 1853/110 | 48 | 1853/177 | 51 | 1855/10 | 178 |
| 1852/14 | 56 | 1852/81 | 53 | 1853/44 | 49 | 1853/111 | 48 | 1853/178 | 51 | 1855/11 | 171 |
| 1852/15 | 56 | 1852/82 | 53 | 1853/45 | 49 | 1853/112 | 48 | 1853/179 | 51 | 1855/12 | 171 |
| 1852/16 | 56 | 1852/83 | 53 | 1853/46 | 49 | 1853/113 | 48 | 1853/180 | 51 | 1855/13 | 171 |
| 1852/17 | 56 | 1852/84 | 53 | 1853/47 | 49 | 1853/114 | 48 | 1853/181 | 51 | 1855/14 | 171 |
| 1852/18 | 56 | 1852/85 | 53 | 1853/48 | 49 | 1853/115 | 48 | 1853/182 | 51 | 1855/17 | 171 |
| 1852/19 | 56 | 1852/86 | 53 | 1853/49 | 49 | 1853/116 | 48 | 1853/183 | 51 | 1855/18 | 171 |
| 1852/20 | 56 | 1852/87 | 53 | 1853/50 | 49 | 1853/117 | 48 | 1853/184 | 51 | 1855/19 | 171 |
| 1852/21 | 56 | 1852/88 | 53 | 1853/51 | 50 | 1853/118 | 48 | 1853/185 | 51 | 1855/20 | 171 |
| 1852/22 | 56 | 1852/89 | 53 | 1853/52 | 50 | 1853/119 | 48 | 1853/186 | 51 | 1855/21 | 171 |
| 1852/23 | 56 | 1852/90 | 53 | 1853/53 | 50 | 1853/120 | 48 | 1853/187 | 51 | 1855/22 | 171 |
| 1852/24 | 56 | 1852/91 | 53 | 1853/54 | 50 | 1853/121 | 48 | 1853/188 | 51 | 1855/23 | 171 |
| 1852/25 | 56 | 1852/92 | 53 | 1853/55 | 50 | 1853/122 | 48 | 1853/189 | 51 | 1855/24 | 171 |
| 1852/26 | 56 | 1852/93 | 53 | 1853/56 | 50 | 1853/123 | 48 | 1853/190 | 51 | 1855/25 | 171 |
| 1852/27 | 56 | 1852/94 | 53 | 1853/57 | 50 | 1853/124 | 48 | 1853/191 | 51 | 1855/26 | 171 |
| 1852/28 | 56 | 1852/95 | 53 | 1853/58 | 50 | 1853/125 | 48 | 1853/192 | 51 | 1857/2 | 245 |
| 1852/29 | 56 | 1852/96 | 53 | 1853/59 | 50 | 1853/126 | 48 | 1853/193 | 51 | 1857/3 | 245 |
| 1852/30 | 56 | 1852/97 | 53 | 1853/60 | 50 | 1853/127 | 48 | 1853/194 | 51 | 1857/4 | 245 |
| 1852/31 | 56 | 1852/98 | 53 | 1853/61 | 50 | 1853/128 | 48 | 1853/195 | 51 | 1857/5 | 245 |
| 1852/32 | 56 | 1852/99 | 53 | 1853/62 | 50 | 1853/129 | 48 | 1853/196 | 51 | 1857/6 | 245 |
| 1852/33 | 56 | 1852/100 | 53 | 1853/63 | 50 | 1853/130 | 48 | 1853/197 | 51 | 1857/7 | 245 |
| 1852/34 | 56 | 1852/101 | 53 | 1853/64 | 50 | 1853/131 | 48 | 1853/198 | 51 | 1857/8 | 245 |
| 1852/35 | 56 | 1852/102 | 53 | 1853/65 | 50 | 1853/132 | 48 | 1853/199 | 51 | 1857/13 | 245 |
| 1852/36 | 56 | 1852/103 | 53 | 1853/66 | 50 | 1853/133 | 48 | 1853/201 | 51 | 1857/14 | 245 |
| 1852/37 | 56 | 1852/104 | 53 | 1853/67 | 50 | 1853/134 | 48 | 1853/202 | 51 | 1857/15 | 245 |
| 1852/38 | 56 | 1853/1 | 49 | 1853/68 | 50 | 1853/135 | 48 | 1853/203 | 51 | 1858/1 | 183 |
| 1852/39 | 56 | 1853/2 | 49 | 1853/69 | 50 | 1853/136 | 48 | 1853/204 | 51 | 1858/2 | 183 |
| 1852/40 | 56 | 1853/3 | 49 | 1853/70 | 50 | 1853/137 | 48 | 1853/205 | 51 | 1858/4 | 183 |
| 1852/41 | 53 | 1853/4 | 49 | 1853/71 | 50 | 1853/138 | 48 | 1853/206 | 51 | 1858/6 | 183 |
| 1852/42 | 53 | 1853/5 | 49 | 1853/72 | 50 | 1853/139 | 48 | 1853/207 | 51 | 1860/1 | 244 |
| 1852/43 | 53 | 1853/6 | 49 | 1853/73 | 50 | 1853/140 | 48 | 1853/208 | 51 | 1860/2 | 244 |
| 1852/44 | 53 | 1853/7 | 49 | 1853/74 | 50 | 1853/141 | 48 | 1853/209 | 51 | 1860/3 | 244 |
| 1852/45 | 53 | 1853/8 | 49 | 1853/75 | 50 | 1853/142 | 48 | 1853/210 | 51 | 1860/4 | 244 |
| 1852/46 | 53 | 1853/9 | 49 | 1853/76 | 50 | 1853/143 | 48 | 1853/211 | 51 | 1860/5 | 244 |
| 1852/47 | 53 | 1853/10 | 49 | 1853/77 | 50 | 1853/144 | 48 | 1853/212 | 51 | 1860/6 | 244 |
| 1852/48 | 53 | 1853/11 | 49 | 1853/78 | 50 | 1853/145 | 48 | 1853/213 | 51 | 1861/1 | 244 |
| 1852/49 | 53 | 1853/12 | 49 | 1853/79 | 50 | 1853/146 | 48 | 1853/214 | 51 | 1861/2 | 244 |
| 1852/50 | 53 | 1853/13 | 49 | 1853/80 | 50 | 1853/147 | 48 | 1853/215 | 51 | 1861/3 | 244 |
| 1852/51 | 53 | 1853/14 | 49 | 1853/81 | 50 | 1853/148 | 48 | 1853/216 | 51 | 1861/4 | 244 |
| 1852/52 | 53 | 1853/15 | 49 | 1853/82 | 50 | 1853/149 | 48 | 1853/217 | 51 | 1861/5 | 244 |

Not all of the Arterferro items are available in **Arterferro Quick**, just a special selection.

Find out about the entire range in the catalogue

In **Arterferro Quick** non sono presenti tutti gli articoli Arterferro, ma solo una speciale selezione.

Scopri la gamma completa nel catalogo

Compendium

INDEX - INDICE

| | | | | | | | | | | | |
|-----------|-----|------------|-----|----------|-----|----------|-----|-----------|-----|---------|-----|
| 1861/6 | 244 | F06920 | 246 | GD92/2 | 130 | GD124/38 | 21 | GD271/2 | 70 | GD303/1 | 121 |
| 1861/7 | 244 | F06921 | 246 | GD92/3 | 130 | GD148/1 | 146 | GD271/3 | 70 | GD303/2 | 121 |
| 1861/8 | 244 | F06922 | 246 | GD99/1 | 143 | GD150/2 | 146 | GD271/5 | 147 | GD303/3 | 121 |
| 1861/9 | 244 | F06923 | 246 | GD106/1 | 95 | GD150/3 | 146 | GD273/9 | 156 | NEW0009 | 112 |
| 1861/10 | 244 | F011971 | 247 | GD106/2 | 95 | GD151/1 | 146 | GD273/10 | 156 | NEW0011 | 112 |
| 1861/11 | 244 | F011974 | 247 | GD106/3 | 95 | GD151/2 | 190 | GD274/9 | 156 | NEW0016 | 112 |
| 1861/12 | 244 | F011976 | 247 | GD106/4 | 95 | GD154/3 | 149 | GD274/11 | 156 | NEW0049 | 245 |
| 1861/13 | 244 | F083500 | 246 | GD106/5 | 95 | GD158/1 | 150 | GD275/1 | 91 | NEW0050 | 245 |
| 1861/14 | 244 | F083510 | 246 | GD106/6 | 95 | GD158/2 | 150 | GD275/2 | 91 | NEW0051 | 245 |
| 1861/17 | 244 | F083520 | 246 | GD106/7 | 95 | GD163/1 | 145 | GD275/3 | 91 | NEW0052 | 245 |
| 1861/18 | 244 | F083600 | 246 | GD106/8 | 95 | GD163/2 | 143 | GD275/5 | 96 | NEW0054 | 245 |
| 1861/19 | 244 | F083610 | 246 | GD106/9 | 95 | GD164/1 | 147 | GD275/7 | 91 | NEW0055 | 245 |
| 1861/20 | 244 | F083620 | 246 | GD106/10 | 95 | GD164/2 | 147 | GD275/8 | 91 | NEW0077 | 63 |
| 1861/21 | 244 | F085500 | 246 | GD106/11 | 95 | GD175/1 | 145 | GD275/9 | 91 | NEW0078 | 63 |
| 1861/22 | 244 | F085510 | 246 | GD106/12 | 95 | GD175/2 | 145 | GD282/2 | 144 | NEW0079 | 64 |
| 1861/16/S | 244 | F085600 | 246 | GD106/13 | 95 | GD175/3 | 145 | GD284/1 | 141 | NEW0080 | 64 |
| 1905/1 | 264 | F085610 | 246 | GD106/14 | 95 | GD175/4 | 145 | GD285/1 | 135 | NEW0081 | 64 |
| 1905/2 | 264 | F085700 | 246 | GD106/15 | 95 | GD175/5 | 145 | GD285/2 | 134 | NEW0082 | 64 |
| 1905/3 | 264 | F085710 | 246 | GD106/16 | 95 | GD175/6 | 145 | GD285/3 | 134 | | |
| 1905/4 | 264 | F085720 | 246 | GD106/17 | 95 | GD175/7 | 150 | GD285/4 | 134 | | |
| 1905/5 | 264 | GD13/1 | 104 | GD106/18 | 95 | GD176/3 | 129 | GD285/5 | 134 | | |
| 1905/6 | 264 | GD16/1 | 137 | GD106/19 | 95 | GD181/1 | 115 | GD285/2/S | 135 | | |
| 1905/7 | 264 | GD16/2 | 137 | GD106/20 | 95 | GD181/2 | 115 | GD286/1 | 134 | | |
| 1905/8 | 264 | GD18/1 | 137 | GD106/21 | 95 | GD181/3 | 115 | GD287/1 | 116 | | |
| 1905/9 | 264 | GD18/2 | 137 | GD106/22 | 95 | GD182/1 | 115 | GD287/2 | 116 | | |
| 1905/10 | 264 | GD19/1 | 114 | GD106/23 | 95 | GD182/2 | 115 | GD287/3 | 116 | | |
| 1905/12 | 264 | GD19/2 | 114 | GD106/24 | 95 | GD183/1 | 115 | GD287/4 | 116 | | |
| 1905/13 | 264 | GD20/1 | 138 | GD106/25 | 95 | GD184/1 | 115 | GD288/1 | 123 | | |
| 1905/14 | 264 | GD20/2 | 138 | GD106/26 | 95 | GD184/2 | 115 | GD289/1 | 122 | | |
| 1905/15 | 264 | GD20/3 | 138 | GD106/27 | 95 | GD187/1 | 136 | GD289/2 | 122 | | |
| 1905/16 | 264 | GD20/4 | 138 | GD124/1 | 46 | GD187/2 | 136 | GD289/1/S | 122 | | |
| 1905/17 | 264 | GD20/5 | 138 | GD124/2 | 46 | GD189/2 | 136 | GD289/2/S | 122 | | |
| 1905/18 | 264 | GD20/6 | 138 | GD124/3 | 46 | GD205/1 | 135 | GD290/1 | 125 | | |
| 1905/19 | 264 | GD20/7 | 128 | GD124/4 | 46 | GD205/2 | 135 | GD290/2 | 125 | | |
| 5069/3 | 258 | GD20/8 | 138 | GD124/5 | 46 | GD209/1 | 135 | GD291/1 | 135 | | |
| 6112/4/S | 55 | GD21/1 | 139 | GD124/6 | 46 | GD211/1 | 140 | GD291/2 | 132 | | |
| 10301/1 | 258 | GD21/2 | 139 | GD124/7 | 46 | GD211/2 | 140 | GD293/1 | 117 | | |
| 10301/2 | 258 | GD21/3 | 139 | GD124/8 | 46 | GD211/3 | 140 | GD293/2 | 127 | | |
| 10314/1 | 258 | GD21/4 | 139 | GD124/9 | 45 | GD211/4 | 140 | GD293/3 | 122 | | |
| 10314/2 | 258 | GD21/5 | 139 | GD124/10 | 45 | GD212/1 | 140 | GD293/3/S | 122 | | |
| 10314/3 | 258 | GD21/6 | 139 | GD124/11 | 45 | GD219/1 | 143 | GD294/1 | 123 | | |
| 10314/4 | 258 | GD22/1 | 144 | GD124/12 | 45 | GD220/1 | 149 | GD294/2 | 123 | | |
| 10315/1 | 258 | GD22/3 | 145 | GD124/13 | 45 | GD222/1 | 129 | GD294/3 | 123 | | |
| 10315/2 | 258 | GD22/6 | 95 | GD124/14 | 45 | GD222/2 | 129 | GD294/1/S | 123 | | |
| 10315/3 | 258 | GD22/6/S | 95 | GD124/15 | 45 | GD223/1 | 129 | GD294/2/S | 123 | | |
| 10315/6 | 258 | GD23/1 | 114 | GD124/16 | 45 | GD228/2 | 147 | GD294/3/S | 123 | | |
| 10316/1 | 258 | GD25/1 | 114 | GD124/17 | 20 | GD232/1 | 142 | GD295/1 | 126 | | |
| F060 | 246 | GD25/3 | 114 | GD124/18 | 20 | GD234/1 | 137 | GD295/2 | 126 | | |
| F061 | 246 | GD31/1 | 142 | GD124/19 | 20 | GD235/1 | 148 | GD296/1 | 127 | | |
| F062 | 246 | GD31/2 | 142 | GD124/20 | 20 | GD236/1 | 143 | GD296/2 | 127 | | |
| F063 | 246 | GD35/1 | 141 | GD124/21 | 20 | GD242/1 | 142 | GD297/1 | 124 | | |
| F064 | 246 | GD35/2 | 141 | GD124/22 | 20 | GD243/2 | 114 | GD297/2 | 124 | | |
| F065 | 246 | GD35/3 | 141 | GD124/23 | 20 | GD248/1 | 75 | GD298/1 | 124 | | |
| F066 | 246 | GD39/3 | 147 | GD124/24 | 20 | GD248/2 | 75 | GD298/2 | 124 | | |
| F069 | 246 | GD43/1 | 128 | GD124/25 | 20 | GD248/4 | 75 | GD299/1 | 118 | | |
| F0181 | 246 | GD45/1 | 128 | GD124/26 | 20 | GD262/1 | 210 | GD299/2 | 118 | | |
| F0222 | 247 | GD45/2 | 128 | GD124/27 | 20 | GD262/2 | 210 | GD299/3 | 118 | | |
| F0223 | 247 | GD58/2 | 114 | GD124/28 | 20 | GD262/3 | 210 | GD299/4 | 118 | | |
| F0631 | 246 | GD58/3 | 114 | GD124/29 | 20 | GD262/4 | 210 | GD300/1 | 133 | | |
| F0681 | 246 | GD59/2 | 114 | GD124/30 | 20 | GD263/1 | 210 | GD300/2 | 133 | | |
| F0682 | 246 | GD59/2/Q14 | 114 | GD124/31 | 20 | GD263/2 | 210 | GD300/3 | 133 | | |
| F01197 | 247 | GD61/1 | 141 | GD124/32 | 20 | GD263/3 | 210 | GD301/1 | 117 | | |
| F02231 | 247 | GD68/1 | 140 | GD124/33 | 21 | GD268/1 | 188 | GD301/2 | 117 | | |
| F06910 | 246 | GD68/2 | 138 | GD124/34 | 21 | GD268/2 | 189 | GD301/3 | 117 | | |
| F06911 | 246 | GD73/1 | 130 | GD124/35 | 21 | GD270/2 | 187 | GD302/1 | 120 | | |
| F06912 | 246 | GD76/1 | 136 | GD124/36 | 21 | GD270/5 | 112 | GD302/2 | 120 | | |
| F06913 | 246 | GD76/2 | 136 | GD124/37 | 21 | GD271/1 | 70 | GD302/3 | 120 | | |



store.arteferro.com



More than 2000 items in just one click
Più di 2000 articoli in un solo click





Il catalogo, comprese tutte le sue parti, è tutelato dalla legge sui diritti d'autore. Sono vietate e sanzionate (se non espressamente autorizzate) la riproduzione in ogni modo e forma (comprese le fotocopie, la scansione, la memorizzazione elettronica) e la comunicazione (ivi inclusi a titolo esemplificativo ma non esaustivo: la distribuzione, l'adattamento, la traduzione e la rielaborazione, anche a mezzo di canali digitali interattivi e con qualsiasi modalità attualmente nota od in futuro sviluppata)

The catalogue, including all its parts, is under copyright law. Any reproduction in any way and form (including photocopies, scans, electronic storages) and communication (including for example: the distribution, the adjustment, the translation and the revision, also through digital interactive channels and any other mode currently known or developed in future) is forbidden and sanctioned (if not clearly authorised).



Ci riserviamo il diritto di apportare variazioni tecniche di fabbricazione e di dimensioni ai prodotti. I prodotti originali possono differire leggermente dalle rappresentazioni fotografiche. A questo proposito non sarà accettato nessun reclamo.

We reserve the right to make technical changes of the production process and of the article's dimensions.

The original item can slightly differ from its picture. Hence no claims can be accepted in this regard.



Ind.i.a. spa declina ogni responsabilità giuridica non legalmente prevista per eventuali errori di stampa.
Ind.i.a. spa disclaims any legal liability not legally foreseen for printing mistakes



La somma massima prevista per i risarcimenti e rappresentata dal valore della merce integra.

The max reimbursement amount foreseen as claim for damages is to be referred to the value of intact goods



Si prega di osservare le direttive legali applicabili nelle varie regioni/nei vari paesi.

You are kindly requested to observe the directives applied in the different areas/countries.



I prezzi indicati sono netti per unità, imballaggio incluso. Tutti i prezzi sono IVA esclusa.

The prices are net per unit, packaging included. All prices are exempt of VAT.



Per ogni articolo è prevista una confezione minima indicata a listino. Eventuali ordini per quantità che differiscono dalla confezione minima o a multipli di essa, potranno essere automaticamente adeguati dall'azienda senza previa autorizzazione.

For each item a minimum packaging unit is foreseen, as indicated in the price-list. In case of orders with different quantities than those of the minimum packaging or multiple of it, the company can adjust them automatically without prior authorisation.



Si applicano le nostre condizioni generali di vendita

Our general sales conditions will be applied

Our sales conditions can be read in our website

Le condizioni di vendita le potete trovare sul sito

Condiciones de venta en nuestro sitio web

Conditions de vente dans notre site

www.gonzatogroup.com/sales_conditions.html

ITALIA - Headquarters

Ind.i.a. spa
Via Vicenza, 6/14
36034 - Malo
Vicenza • Italia
tel. +39 0445 580 580 • fax: +39 0445 580 874
info@india.it • www.india.it

U.S.A.

Indital US Ltd
7947 Mesa Drive
77028 - Houston
Texas • U.S.A.
tel. +1 713 694 6065 • fax: +1 713 694 2055
forgings@indital.com • www.indital.com

FLORIDA - CARAIBI

Arteferro Miami LLC
2955 NW 75th Street
33147 - Miami
Florida • U.S.A.
tel. +1 305 836 9232 • fax: +1 305 836 4113
info@arteferromiami.com • www.arteferromiami.com

ITALIA

Nuova Co.Ge.Me. srl
Via Enrico Fermi 34
26041 - Casalmaggiore
Cremona • Italia
tel. +39 0375 284820 • fax +39 0375 203877
info@cogemesteel.com

DEUTSCHLAND

Triebenbacher Betriebsgesellschaft mbH
Gutenbergstraße 1
85737 Ismaning
Deutschland
tel. +49 (0) 89/57 09 28 50 • fax: +49 (0) 89/57 09 28 38
info@triebenbacher.de • www.triebenbacher.de

FRANCE

Ind.i.a. France Sarl
P.A.E. la Baume, 7 Rue de l'Artisanat
34290 - Servian
Servian • France
tel. +33 (0) 4 67 39 42 81 • fax: +33 (0) 4 67 39 20 90
info@indiafrance.eu • www.indiafrance.eu

HRVATSKA

Arteferro Dohomont doo
Gospodarska 1/A
40324 - Goričan
Goričan • Hrvatska
tel. +385 (0) 40 602 222 • fax: +385 (0) 40 602 230
info@arteferro-dohomont.hr • www.arteferro-dohomont.hr

ESPAÑA

Ind.i.a. España, SL
C/ Abedul, 43 – Polig. Ind. El Guijar
28500 - Arganda del Rey
Madrid • España
tel. +34 918 700 819 • fax: +34 918 700 820
info@arteferro.es • www.arteferro.es

РОССИЯ

ООО "АРТЕФЕРРО-РУССИЯ"
603124, Россия, Нижний Новгород, Вторчермета 1Г
Тел. +7-831-2621999
info@arteferrorussia.com
www.arteferro.ru

УКРАЇНИ

Arteferro Ukraina
Автоваркова, 5
02660 - Киев
Україна
tel. +380 44 492 03 31 • fax: +380 44 492 03 32
office@arteferroukraine.com • www.arteferroukraine.com

SVERIGE - DANMARK

Arteferro Skandinavien AB
Röda Stugans gata 2
602 28 - Norrköping
Sverige
tel. +46 (0) 11 18 23 23 • fax: +46 (0) 11182328
info@arteferro.se • www.arteferro.se

MÉXICO

Arteferro Monterrey SA de CV
Privada la Puerta 2879 B-4
66350 - Col. Parque Industrial - La Puerta Santa Catarina
Nuevo Leon • México
tel. +52 1 81 1295 5094/95 • fax: +52 1 81 1295 5097
info@arteferromexico.com • www.arteferromexico.com

ARGENTINA

Arteferro Argentina SA
Suárez 760
1162 - Buenos Aires
Argentina
tel. +54 11 4301 2637 • fax: +54 11 4301 2637
info@arteferroargentina.com • www.arteferroargentina.com

CHILE

Arteferro Chile SA
Calle Los Arrayanes, 250, bodega 4
9340000 - Santiago
Colina • Chile
tel. +56 2 738 7419 • fax: +56 2 738 7419
arteferro@arteferrochile.cl • www.arteferrochile.cl

中华人民共和国

China (Shandong province)
Representative Far East
india@arteferro.com

BRASIL

Ind.i.a. Brasil LTDA
Rua Padre Feijó, 480
95190-000 - São Marcos
Rio Grande do Sul • Brasil
tel. +55 54 3291 1416 • fax: +55 54 3291 1416
Branch
Av. Almirante Cochrane, 194 – Sala 32
11040-200 – Santos - Sao Paulo • Brasil
tel. +55 13 21389091
vendas@arteferrobrazil.com.br
www.arteferrobrazil.com.br



www.arteferro.com



You
Tube

