



www.arteferro.com

arteferro

VERTICAL METALS

VERTICAL METALS

It's called Vertical Metals and is the new line for ornamental façades systems branded Arteferro. Patented design, green material, it can be a siding but also a stand-alone structure or a partial/total coverage. From the eras of Romanticism and Art Nouveau this is the first conceptual reworking of a classic material like wrought iron that, also maintaining the typical craftmade finishing, takes on a completely new design characterized by unusual tridimensionality. Vertical Metals are perfectly suited to the building's geometry as if they were a second skin. Ideal for both the restoration and the new construction, the architectural applications are really numerous for buildings and spaces both modern and historical. The coating modules are made on designs patented by Gonzato Group and ensure a sustainable architecture thanks to the possibility to recycle the 100% of the components.

Three different systems for unlimited stylistic combinations: Roma, (p. 3) Firenze (p. 8) and Venezia (p. 10).

Si chiama Vertical Metals ed è la nuova linea di sistemi per facciate ornamentali marchiate Arteferro. Design brevettato, materiale green, può essere un rivestimento ma anche una struttura a sé stante, a copertura parziale o totale. Dalle epoche del Romanticismo e dell'Art Nouveau è la prima rielaborazione concettuale dell'utilizzo di un materiale classico come il ferro battuto che, pur mantenendo la tipica finitura artigianale, assume un design completamente nuovo dalle insolite tridimensionalità. Le Vertical Metals si adattano perfettamente alle geometrie degli edifici come fossero una seconda pelle. Ideali sia per la ristrutturazione che per la nuova costruzione, le applicazioni architettoniche sono molteplici per edifici e spazi sia moderni che storici. I moduli di rivestimento sono realizzati su disegni brevettati da Gonzato Group ed assicurano una architettura sostenibile grazie alla possibilità di riciclare al 100% i componenti utilizzati. Tre diversi sistemi per infinite combinazioni stilistiche: Roma, (pag. 3) Firenze (pag. 8) e Venezia (pag. 10).





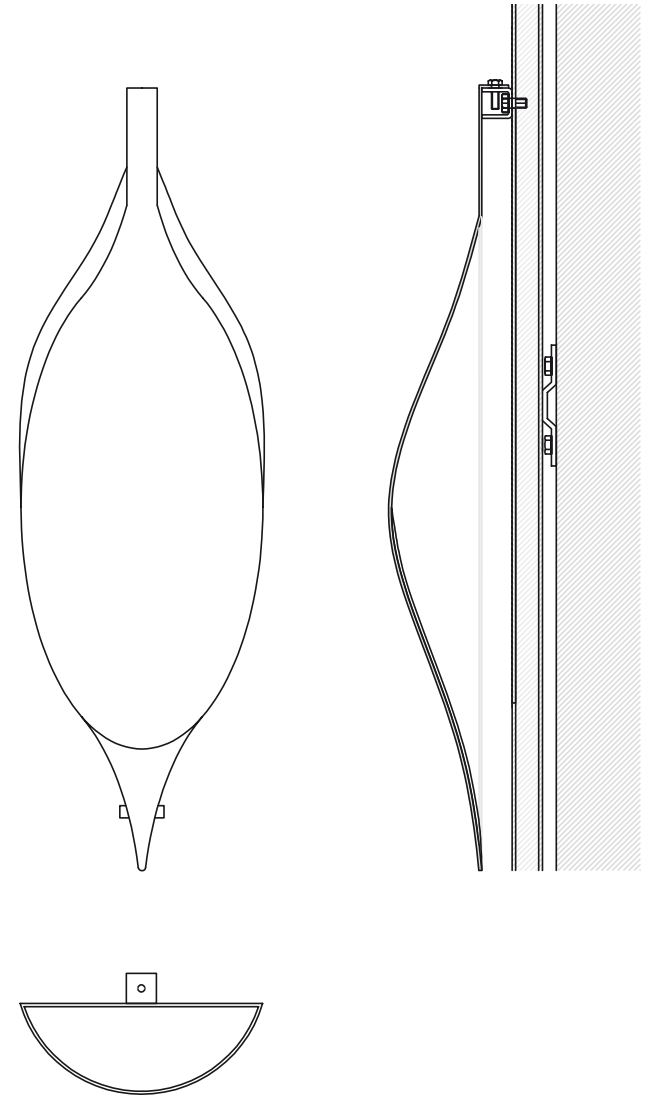
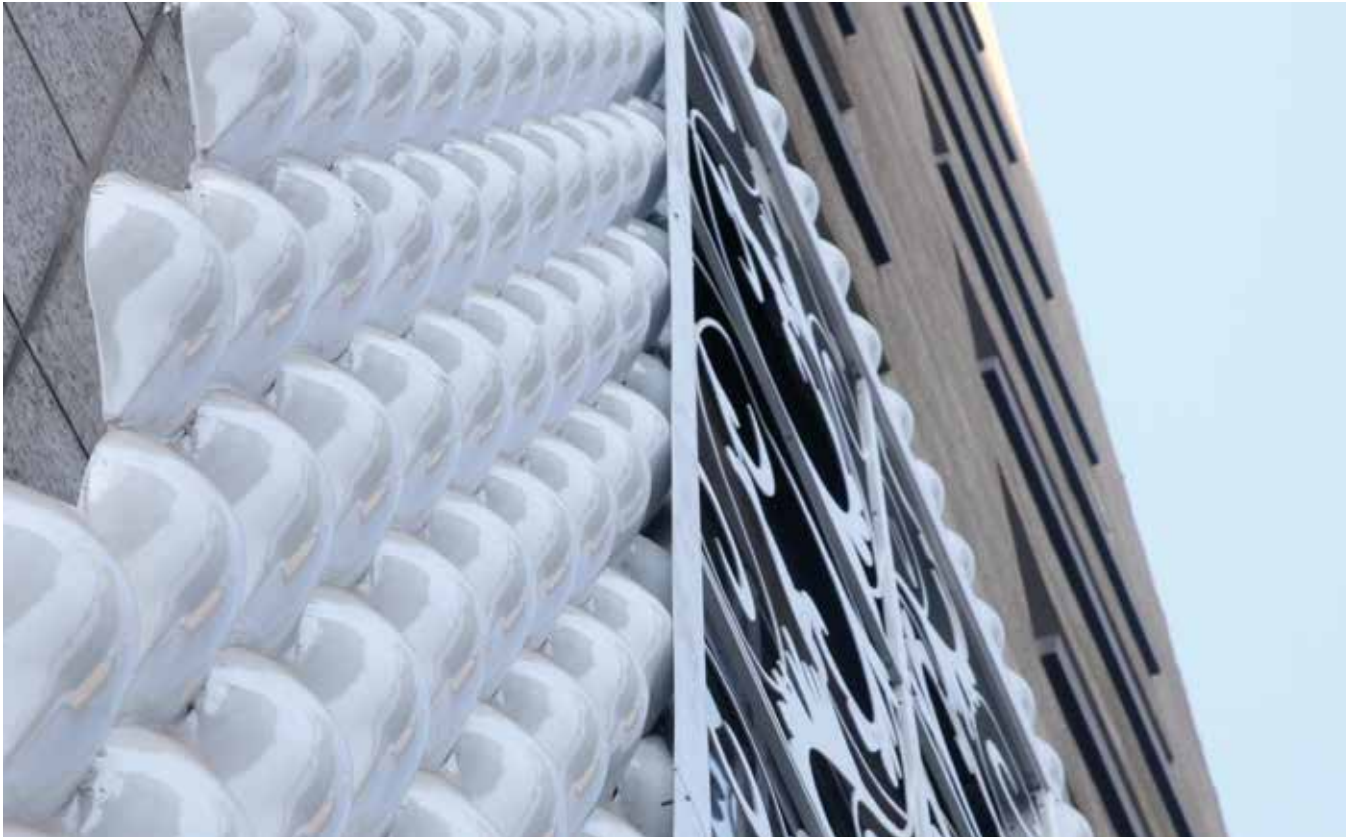

Details of the coating composition
Dettagli della composizione del rivestimento

ROMA

A total coverage, like a second skin, characterized by personalized elements of different shapes and finishing, realized mainly by forging and stuffing procedures. These elements are anchored to a modular structure fixed on the wall. The final result is a total covering structure that therefore conforms as a second wrap of the building or as an element on its own.

Una copertura totale, come una seconda pelle, caratterizzata da elementi personalizzabili in varie forme e finiture, realizzati per la maggior parte attraverso processi di forgiatura ed imbottitura. Tali elementi vengono ancorati ad una struttura modulare retrostante a scomparsa, fissata alla parete. Il risultato finale è una struttura totalmente coprente che si conforma quindi come un secondo involucro dell'edificio o come elemento a sé stante.

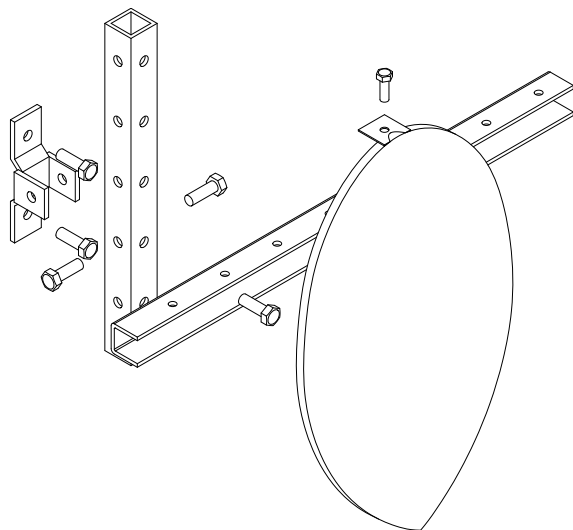

the total covering siding
il rivestimento a copertura totale

Mod. Marte

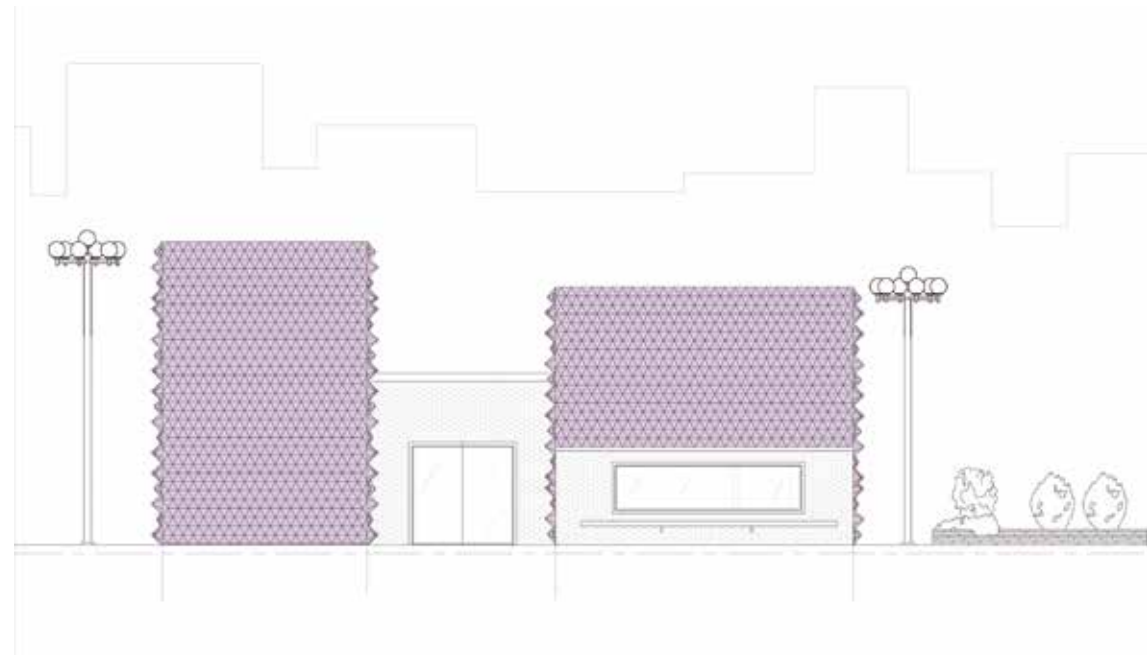
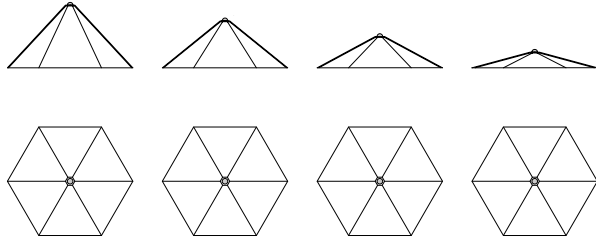

Mod. Nettuno

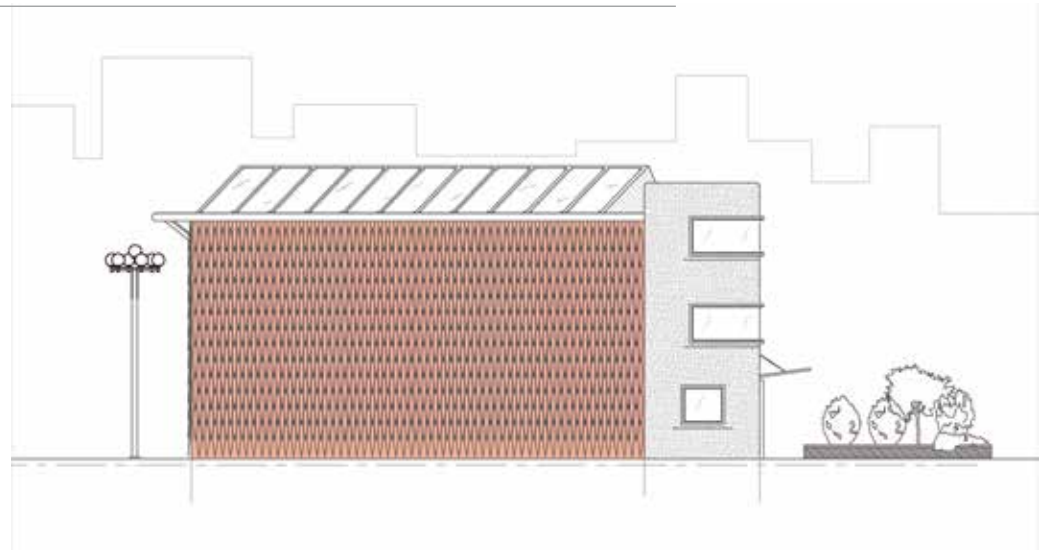
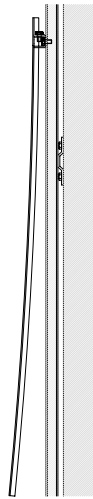

Mod. Minerva

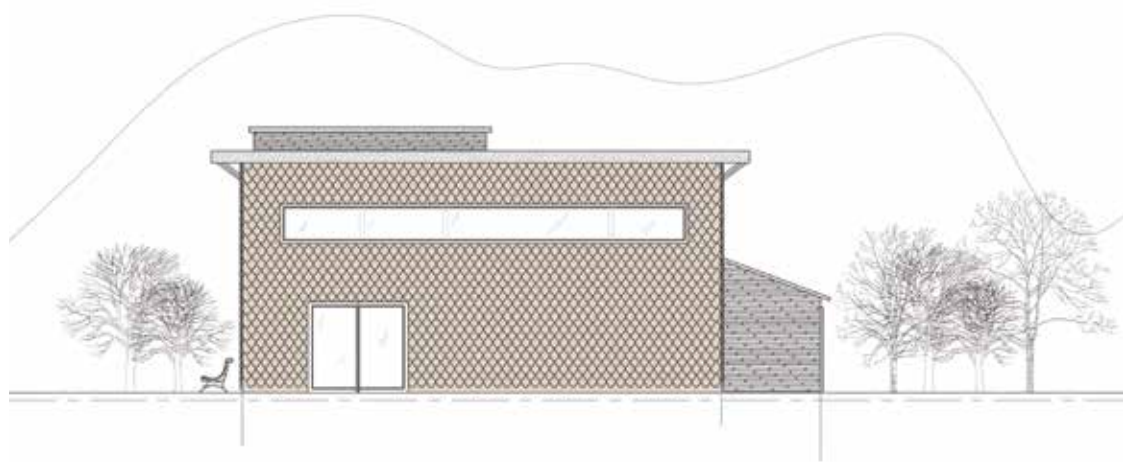
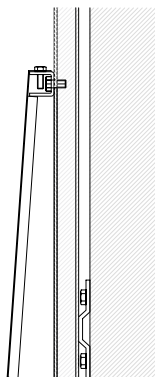
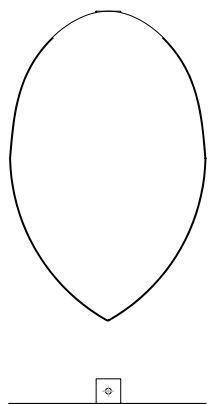

Mod. Fortuna

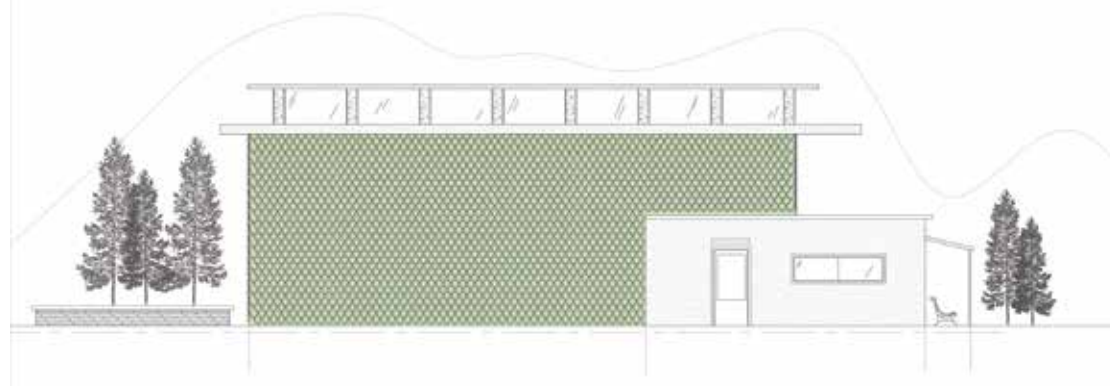
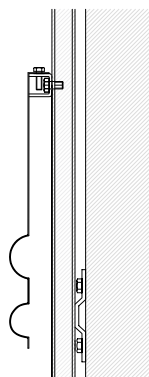
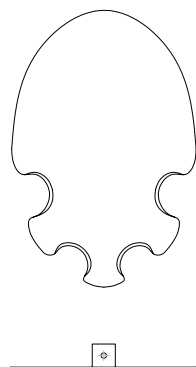
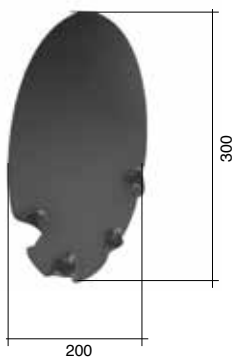

Mod. Diana

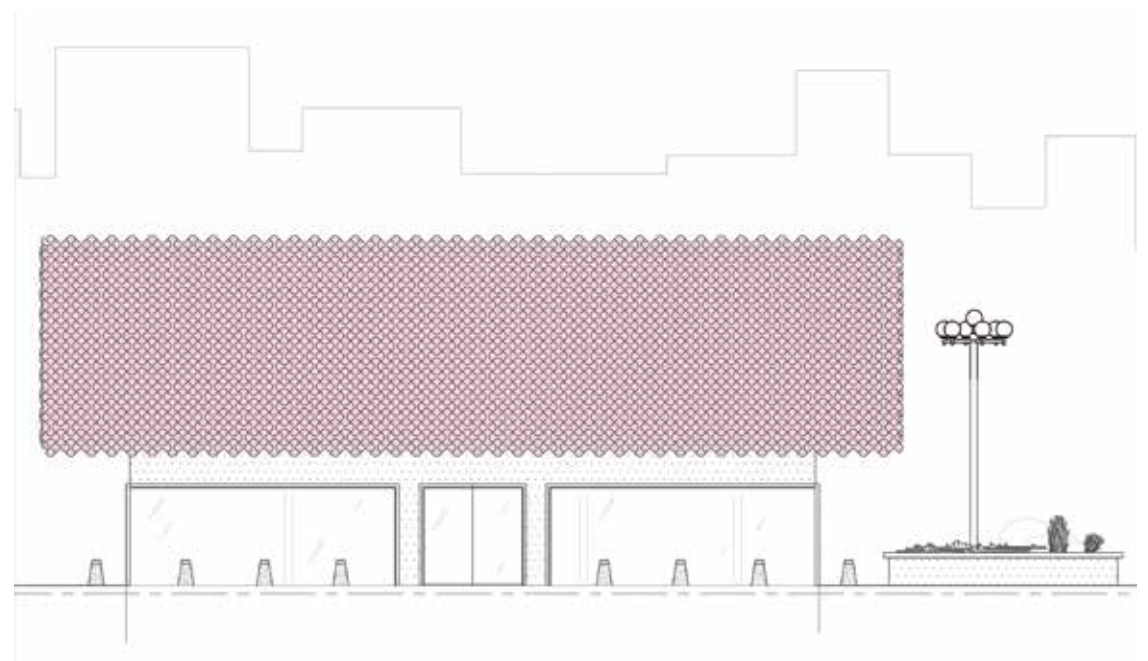
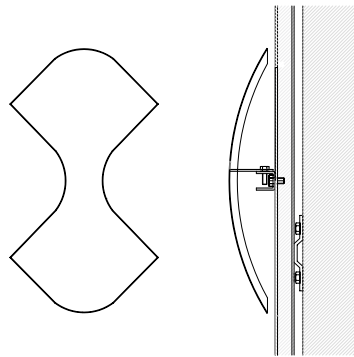
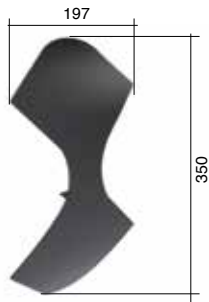

Mod. Venere

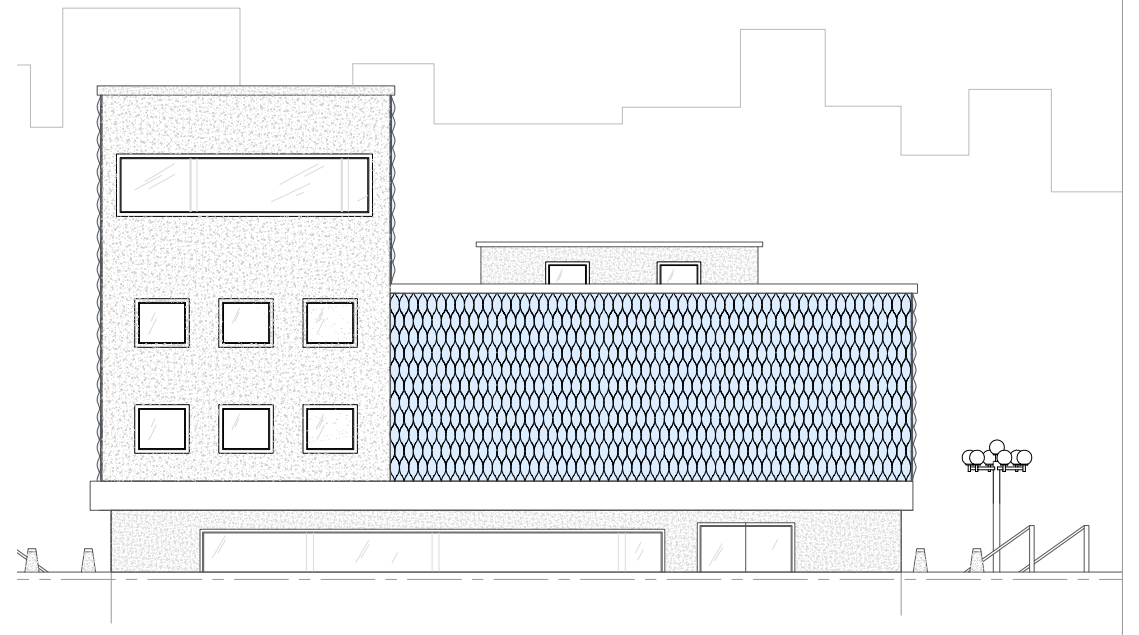
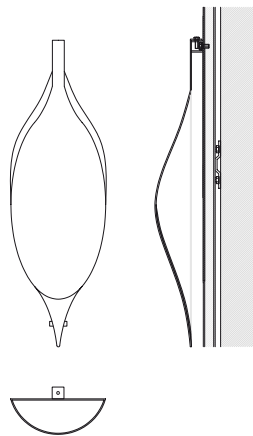

Mod. Apollo

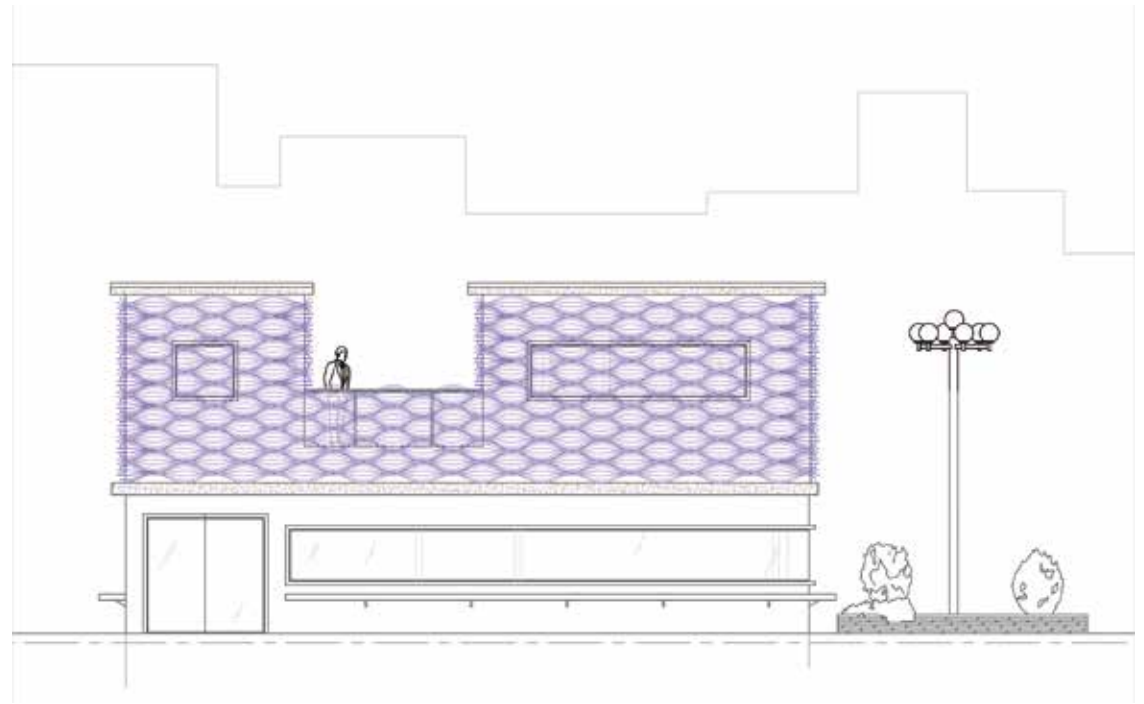
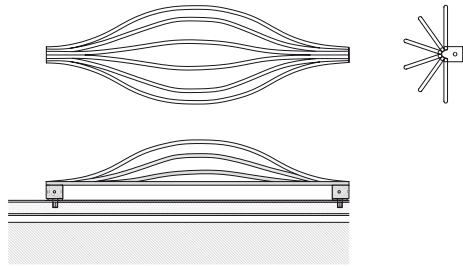
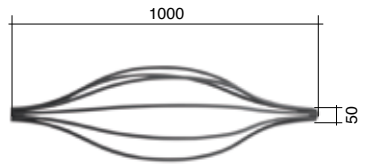

Mod. Mercurio

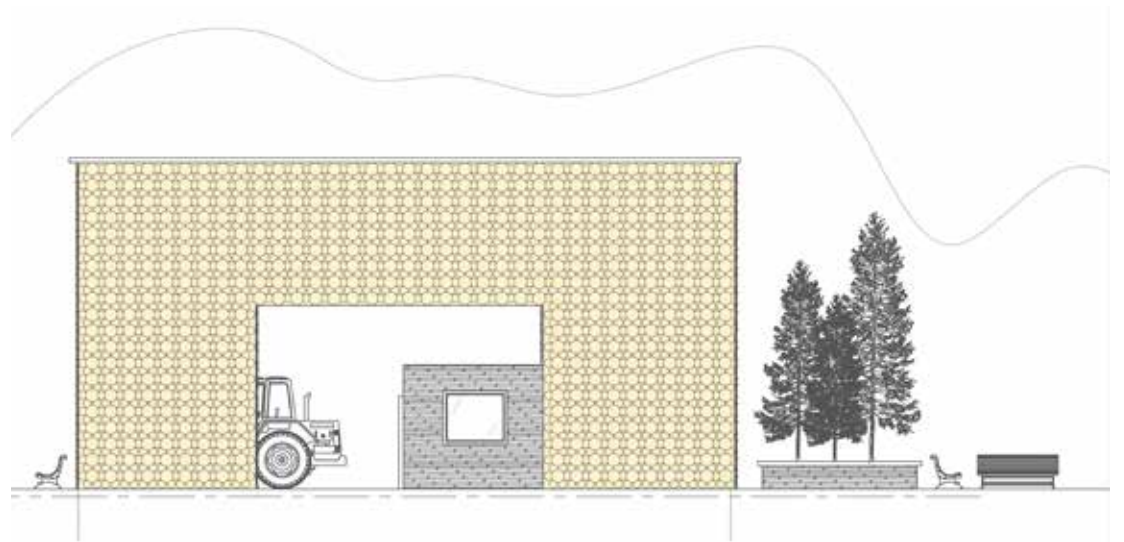
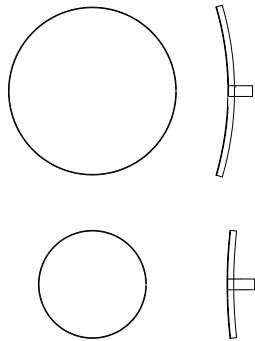
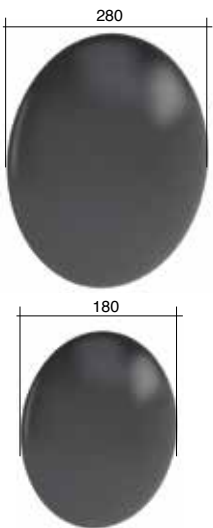



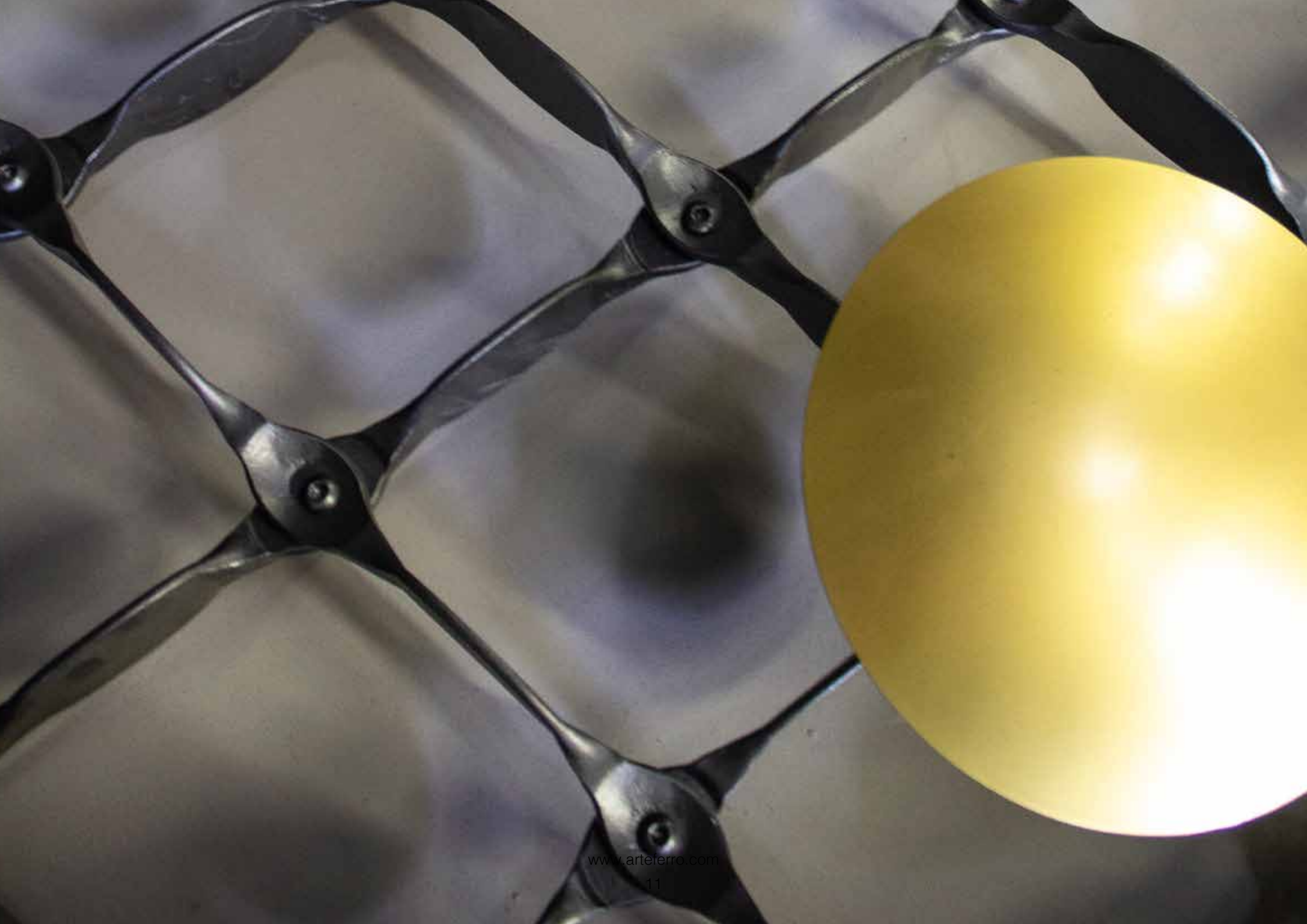

FIRENZE

A modular metallic grid that wraps or creates the surfaces. Realized by a hot forged process it is a grid that for its intrinsic characteristics, also on its own, becomes an high quality ornament. The structure can be embellished further more and personalised by the application of decorative elements of different shapes and materials. An innovative solution for ornamental façades of design.

Una maglia metallica modulare che avvolge le superfici o le crea: realizzata attraverso il processo di forgiatura a caldo, costituisce una griglia che, già di per sé, costituisce un ornamento di gran pregio. Tale struttura può essere ulteriormente impreziosita e personalizzata applicando elementi decorativi di forme e materiali differenti. Una soluzione innovativa per facciate ornamentali di design.

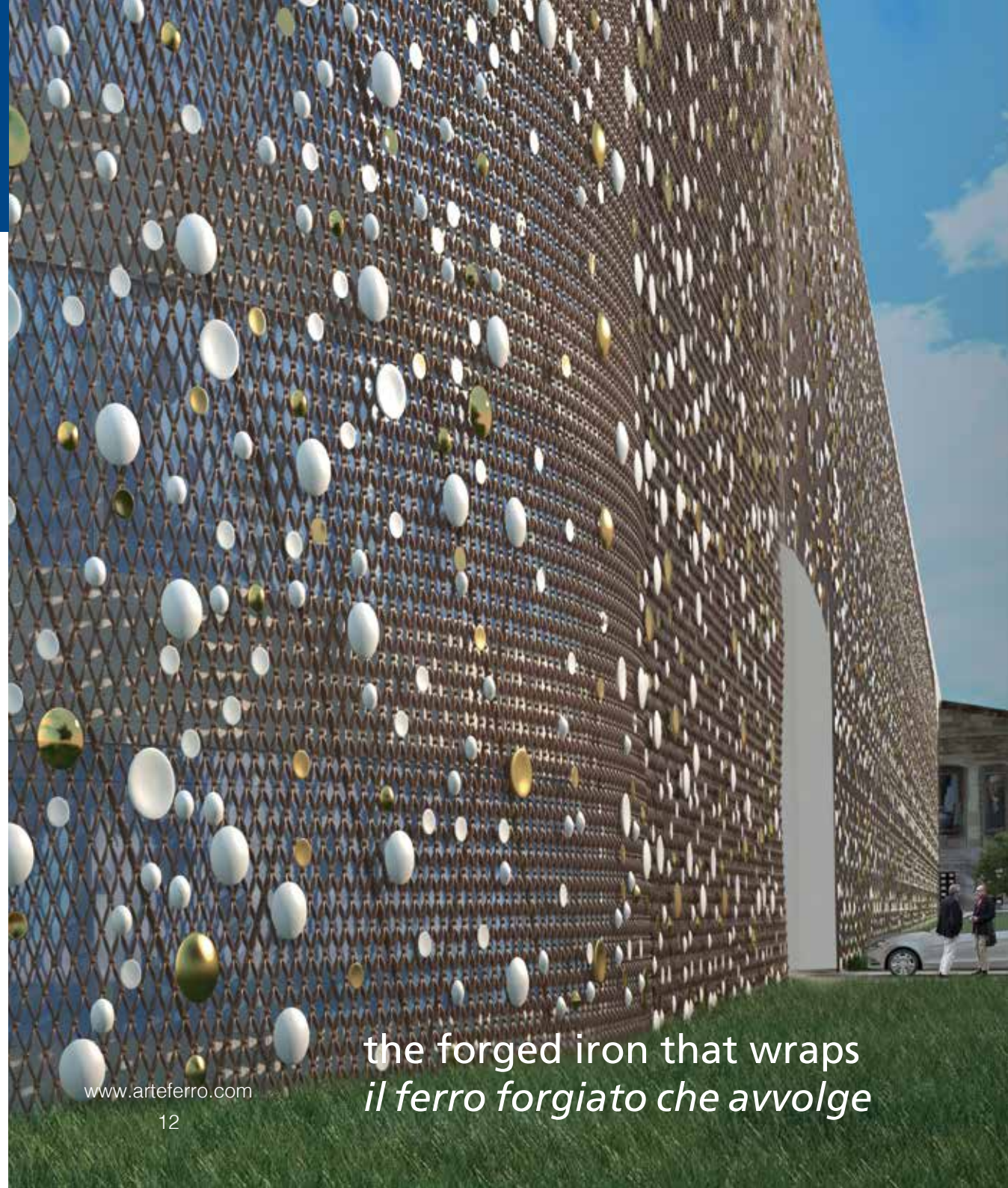
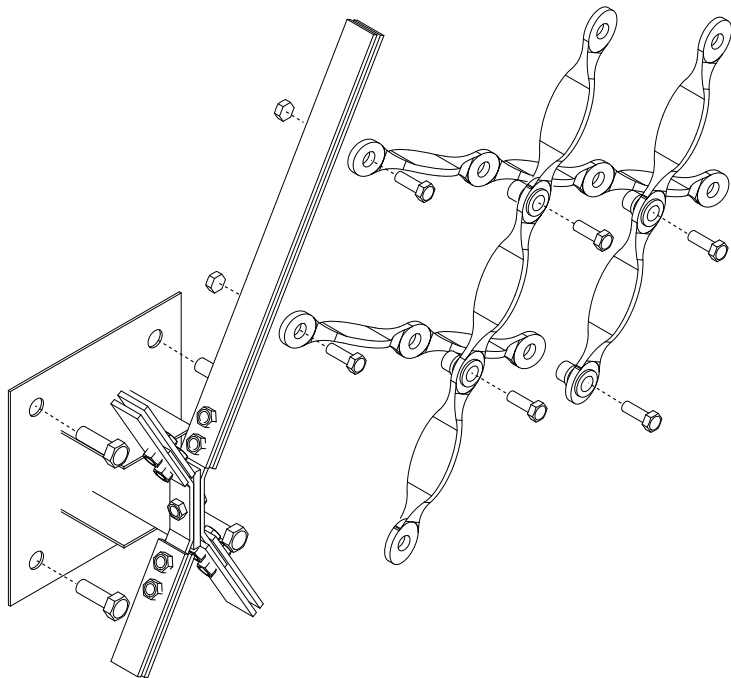

www.arteferro.com

the forged iron that wraps
il ferro forgiato che avvolge

The Vulcan model can be adapted to curved and inclined surfaces. It's anchored to an alveolar support structure or, in the case of application on small surfaces, it can be fixed directly on the wall.

Il modello Vulcano può essere adattato a superfici curve ed inclinate. Viene ancorato ad una struttura di supporto alveolare oppure, nel caso di applicazione su superfici ridotte, può essere fissato direttamente a parete.

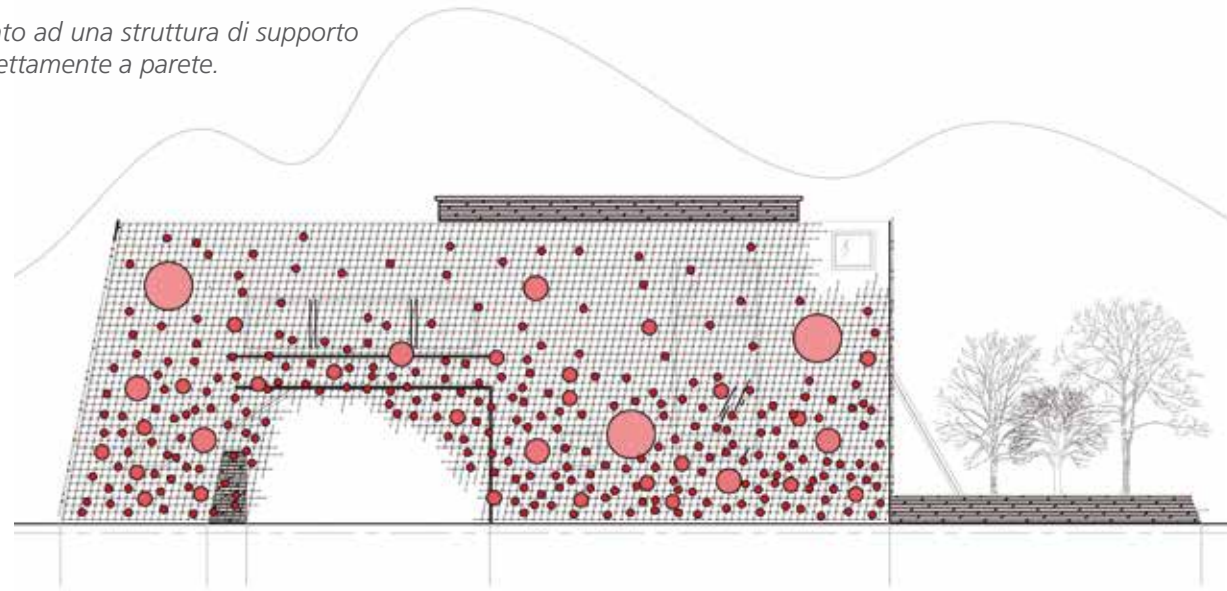
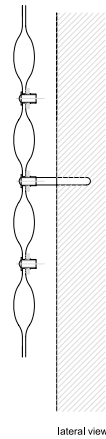
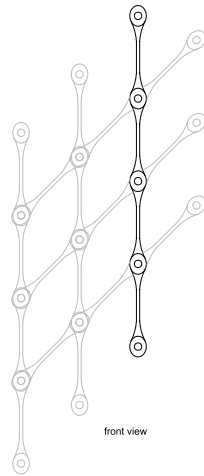
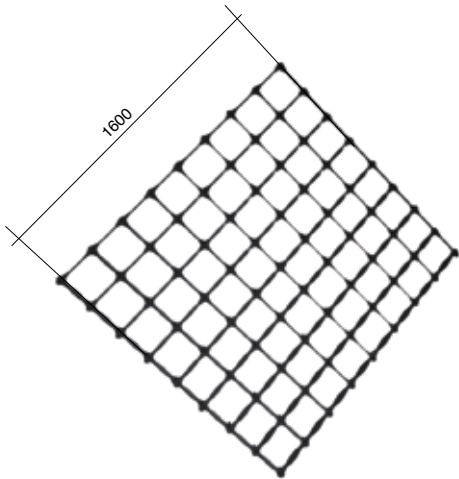

VENEZIA

A modular system composed by metallic panels of the unmistakable Gonzato Design style. Tradition and modernity melt and create aesthetical solutions of avant-garde. The wide range of available panels, that can be anchored to the walls or to the proper structures by the appropriate stirrups, allows the designer to find the optimal aesthetic solutions. Venezia System: new application perspectives for the Gonzato Designs products.

Un sistema modulare composto da pannelli di metallo dall'inconfondibile stile Gonzato Design. Tradizione e modernità si combinano e creano soluzioni estetiche d'avanguardia. La vasta gamma di pannelli disponibili, ancorabili alle murature o alle strutture preposte mediante apposite staffe, consente al progettista di individuare soluzioni estetiche ottimali. Venezia System: nuove prospettive applicative per i prodotti Gonzato Design.

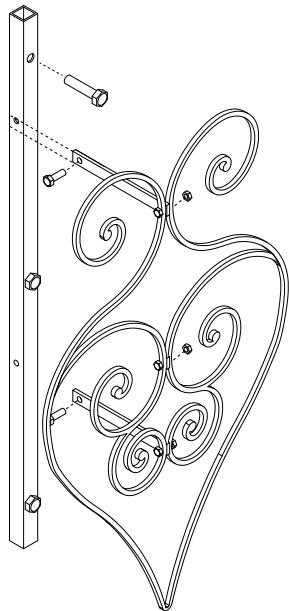

Mod. Cupido

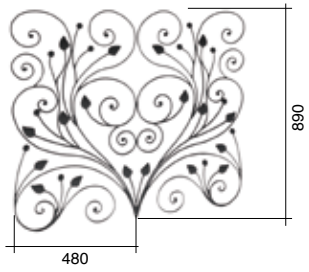

Mod. Vittoria

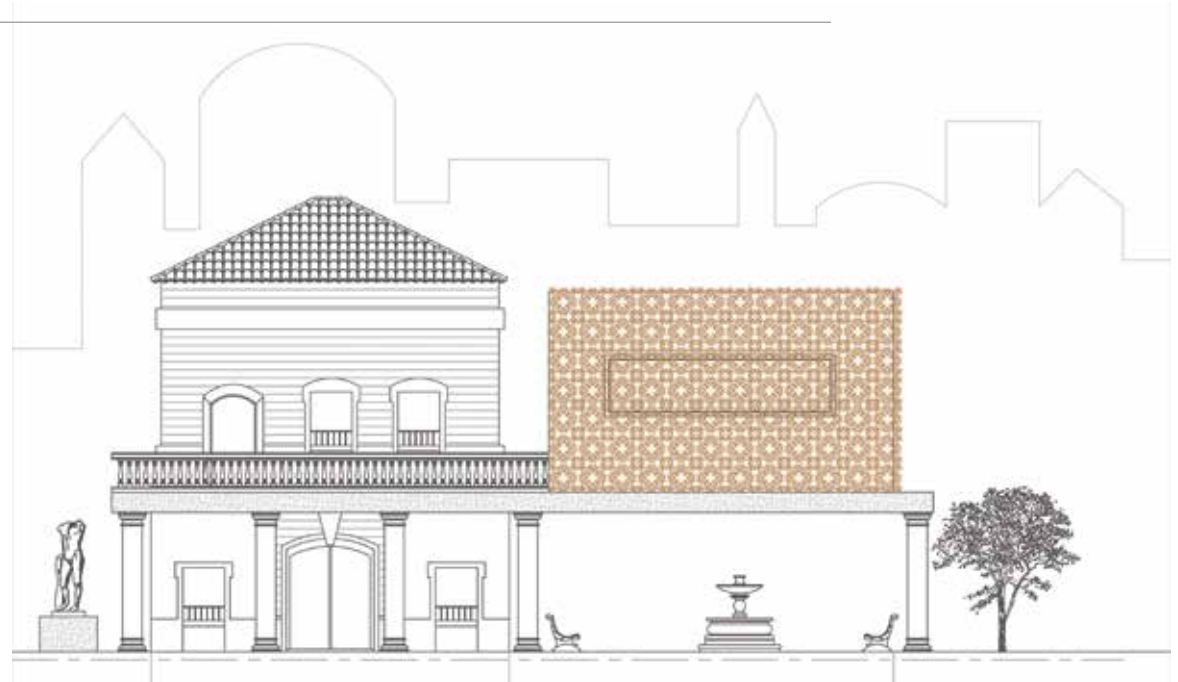
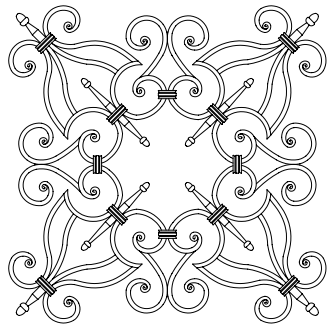
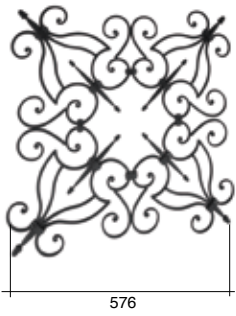

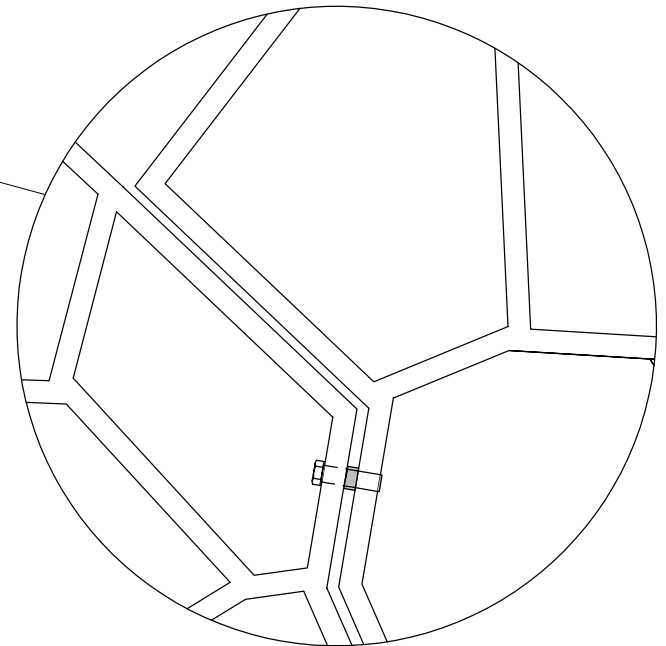
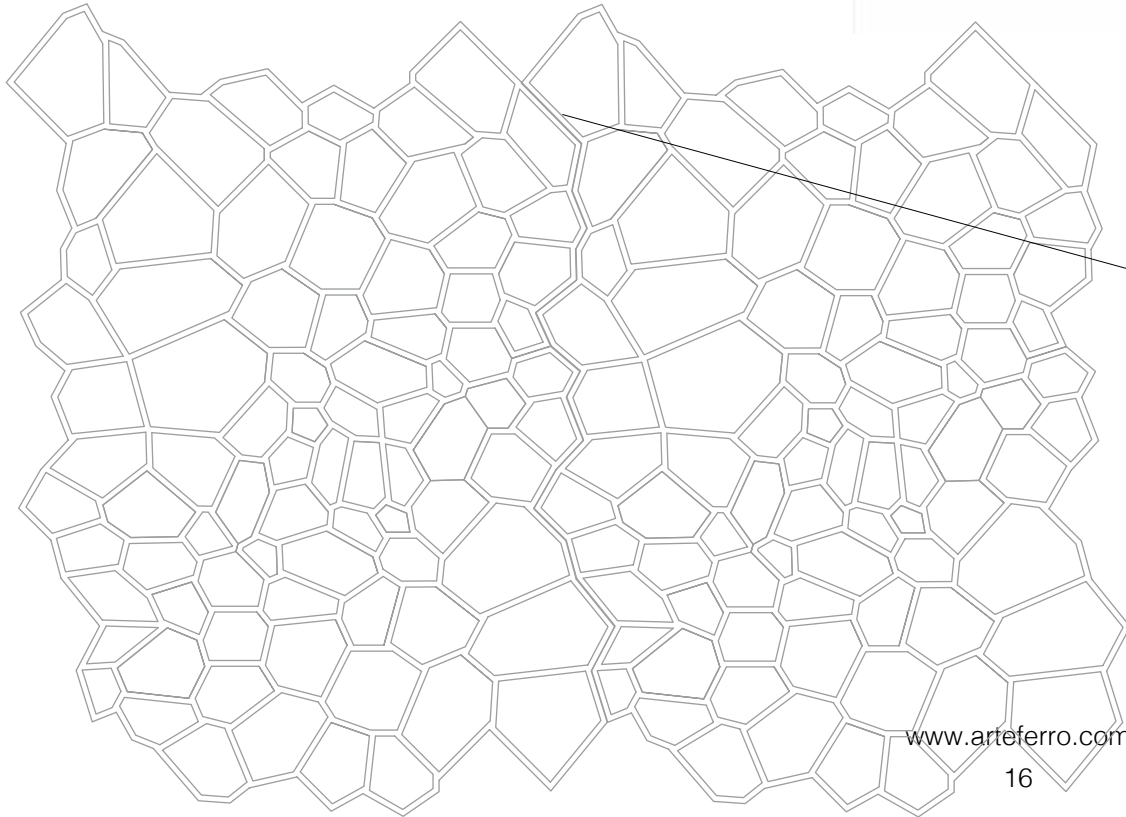
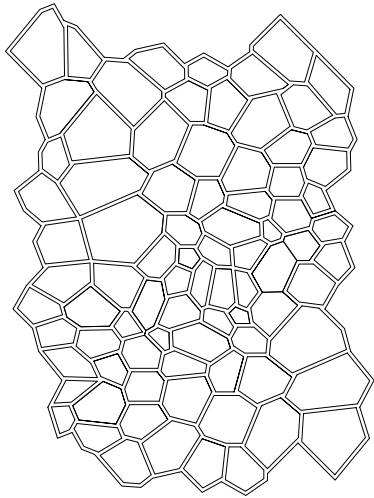
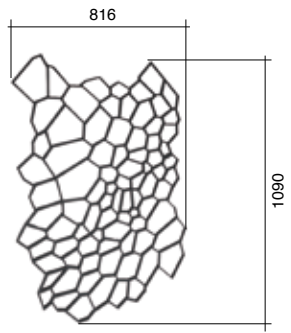

Materials

Materiali

Vertical Metals can be made with different combinations of metals, thus giving to the surrounding environment a refined and exclusive taste.

Le Vertical Metals possono essere realizzate con diverse combinazioni di metalli, conferendo così all'ambiente nel quale sono installate un gusto raffinato ed esclusivo



ECO-FRIENDLY - 100% RECYCLABLE

The Arteferro elements are 100% recyclable: they can be recovered to produce new objects.
Gli elementi Arteferro sono riciclabili al 100%: possono quindi essere rifusi per produrre nuovi oggetti.



Iron
Ferro



Satin finished Stainless steel
Acciaio Satinato



Polished Stainless steel
Acciaio Lucido



Aluminium
Alluminio



Copper
Rame

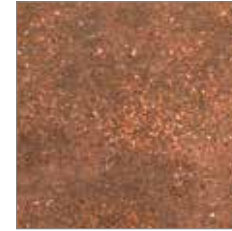

Cor-ten



Satin finished Brass
Ottone Satinato



Polished Brass
Ottone Lucido

Painting

All elements can be powder coated, a metallic surface covering procedure done with an organic film; that is created both for decorative purposes and protection against corrosion and strong agents. In addition to all RAL colours, several finishes are available on demand.

Verniciature

Tutti gli elementi possono essere verniciati a polveri, un procedimento di rivestimento delle superfici metalliche con un film organico, effettuato sia a scopo decorativo sia a scopo di protezione dalla corrosione e dagli agenti aggressivi. Sono disponibili tutti i colori della cartella RAL, più alcune finiture speciali su richiesta che realizziamo grazie al nostro team di maestri verniciatori.

Texture finishings - Finiture speciali materiche



Micaceous Grey
Grigio Micaceo



Black
Nero



Verdigris effect
Effetto Verde Rame



White
Bianco



Cor-ten effect
Effetto Cor-ten



Acid-etched effect
Effetto Acidato



All colours on RAL chart
Tutti i colori su tavola RAL

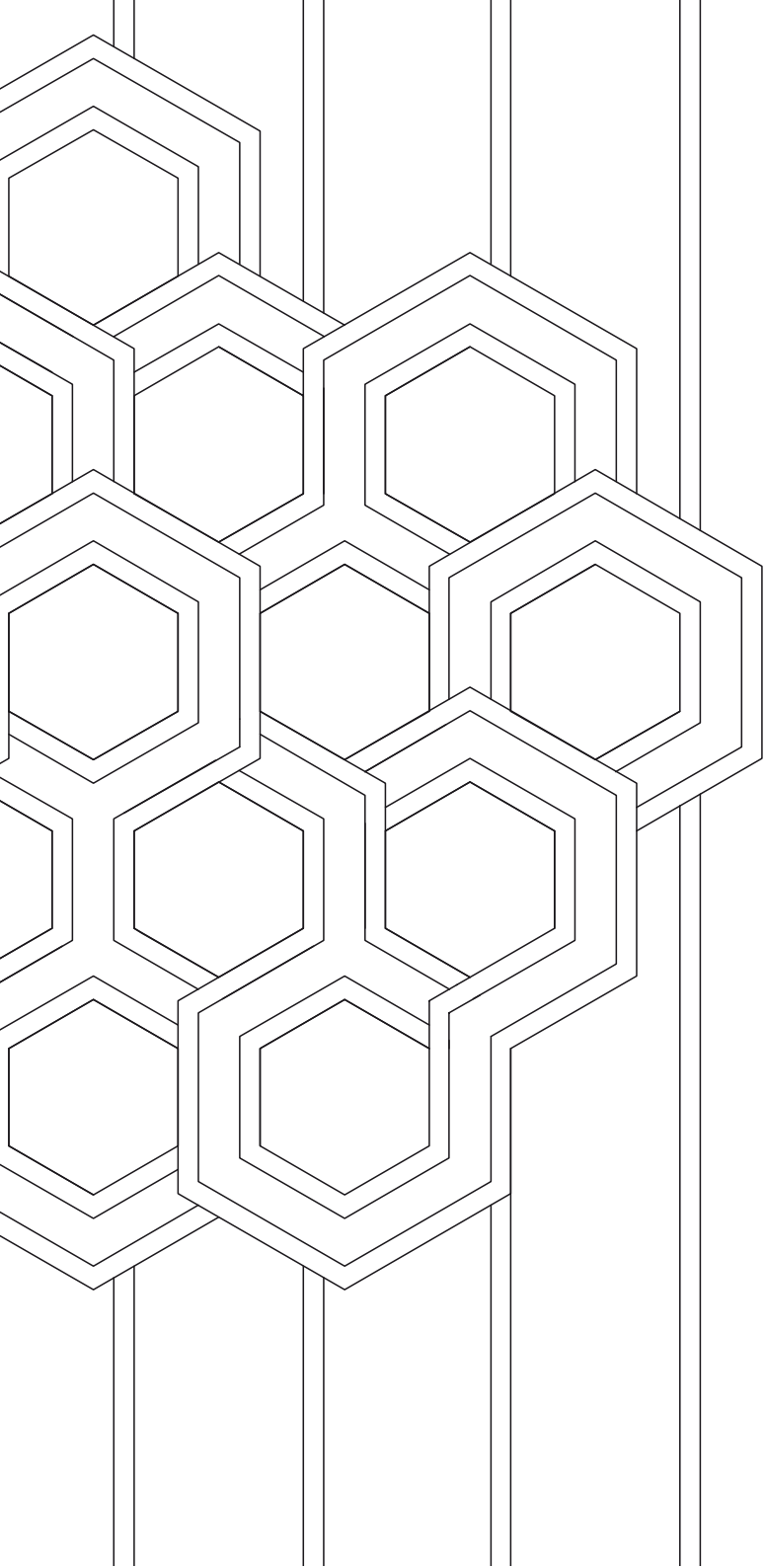

DESIGN YOUR FAÇADE WE WILL MAKE IT FOR YOU

DISEGNA LA TUA FACCIATA LA REALizzerEMO PER TE

Besides the catalogue's items, Arteferro quickly fulfills also the most particular needs: our team of designers and technicians is available to design and create customized items, also based on the project of the designer, and create exceptional and unique façades.

In Arteferro customers and their demands deserve the focus of attention: the designers and engineers team daily works to design new products in harmony with current technical requirements so they will be, easy to install and to integrate with other architectural elements.

Oltre ai numerosi articoli presenti a catalogo Arteferro soddisfa anche le esigenze più particolari: un team di progettisti e tecnici è a disposizione per progettare e realizzare elementi ad hoc, anche su disegno personalizzato dal progettista, e creare così facciate eccezionali ed uniche.

In Arteferro il cliente e le sue esigenze sono al centro dell'attenzione: un team di designer ed ingegneri lavora quotidianamente all'ideazione di nuovi prodotti che soddisfino sempre più la necessità di bellezza, in armonia con le esigenze tecniche oggi esistenti, che siano facili da installare e da integrare con gli altri elementi architettonici, adattandosi all'ambiente.

www.arteferro.com



**METAL IN ARCHITECTURE
SINCE 1971**



GONZATO
GROUP



www.gonzato.com

OUR BRANDS

arteferro

WM
DESIGN

GONZATO GROUP ITALIA

Ind.i.a. spa
Via Vicenza, 6/14
36034 - Malo
Vicenza • Italia
tel. +39 0445 580 580 • fax: +39 0445 580 874
info@india.it • www.india.it

GONZATO GROUP USA-HOUSTON

Indital US Ltd
7947 Mesa Drive
77028 - Houston
Texas • U.S.A.
tel. +1 713 694 6065 • fax: +1 713 694 2055
forgings@indital.com • www.indital.com

GONZATO GROUP USA-MIAMI

Arteferro Miami LLC
2955 NW 75th Street
33147 - Miami
Florida • U.S.A.
tel. +1 305 836 9232 • fax: +1 305 836 4113
info@arteferromiami.com • www.arteferromiami.com

GONZATO GROUP FRANCE

Ind.i.a. France Sarl
P.A.E. la Baume, 7 Rue de l'Artisanat
34290 - Servian
Servian • France
tel. +33 (0) 4 67 39 42 81 • fax: +33 (0) 4 67 39 20 90
info@indiafrance.eu • www.indiafrance.eu

GONZATO GROUP CROATIA

Arteferro Gorican d.o.o.
Gospodarska ulica 1°
40324 Goričan – Međimurje
tel. +385 (0) 40 602 222 • fax: +385 (0) 40 602 230
info@arteferro-dohomont.hr • www.arteferro-dohomont.hr

GONZATO GROUP ESPAÑA

Ind.i.a. España, SL
C/ Abedul, 43 – Políg. Ind. El Guijar
28500 - Arganda del Rey
Madrid • España
tel. +34 918 700 819 • fax: +34 918 700 820
info@arteferro.es • www.arteferro.es

GONZATO GROUP RUSSIA

ООО "АРТЕФЕРРО-РУССИЯ"
603124, Россия, Нижний Новгород, Вторчермета 1Г
Тел. +7-831-2621999
info@arteferrorussia.com
www.arteferro.ru

GONZATO GROUP MEXICO

Arteferro Monterrey SA de CV
Privada la Puerta 2879 B-4
66350 - Col. Parque Industrial - La Puerta Santa Catarina
Nuevo Leon • México
tel. +52 1 81 1295 5094/95 • fax: +52 1 81 1295 5097
info@arteferromexico.com • www.arteferromexico.com

GONZATO GROUP ARGENTINA

Arteferro Argentina SA
Suárez 760
1162 - Buenos Aires
Argentina
tel. +54 11 4301 2637 • fax: +54 11 4301 2637
info@arteferroargentina.com • www.arteferroargentina.com

GONZATO GROUP CHILE

Arteferro Chile SA
Calle Los Arrayanes, 250, bodega 4
9340000 -Santiago
Colina • Chile
tel. +56 2 738 7419 • fax: +56 2 738 7419
arteferro@arteferroschile.cl • www.arteferroschile.cl

GONZATO GROUP CHINA

China (Shandong province)
Representative Far East
india@arteferro.com

GONZATO GROUP BRASIL

Ind.i.a. Brasil LTDA
Rua Padre Feijó, 480
95190-000 - São Marcos
Rio Grande do Sul • Brasil
tel. +55 54 3291 1416 • fax: +55 54 3291 1416
Branch
Av. Almirante Cochrane, 194 – Sala 32
11040-200 – Santos - Sao Paulo • Brasil
tel. +55 13 21389091
vendas@arteferrobrasil.com.br
www.arteferrobrasil.com.br



GONZATO

GROUP

Arteferro is a brand of Gonzato Group
Via Vicenza, 6/14 (SP46) - 36034 Malo (Vicenza) Italy / T +39 0445 580 580 - F +39 0445 580 874
info@arteferro.com - www.arteferro.com

